

MTSB-6032Seated

59.5" x 31.25" x 19.5"

GENERAL SPECIFICATIONS:

Material - Acrylic
 Shipping Weight - 100 lbs / 45 kg
 Threshold - Low-Profile, Seated
 Drain Location - End



Shown above with right-hand drain.

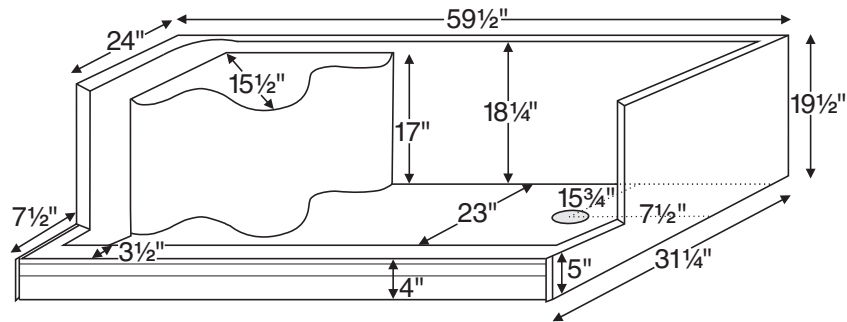

When ordering, please specify left- or right-hand drain.

Model #	Size	Shape	MSRP
SB6032Seated	59.5" x 31.25" x 19.5"	Rectangle	\$1,555

Options
<p>Color Please specify color on order White (CWH) Biscuit (CBS)</p>
<p>Quick Ship (QSPRI) \$380 Reduces lead time. Please call for availability.</p>
<p>Radiance® (RAD100) \$1,080 Shower floor heating system. Radiance heating grids are fully integrated within the acrylic shell structure of the shower floor. Requires a 110-volt, 15 amp GFCI and remote installation of control box & keypad.</p>
<p>Pre-Levelled Foam Base (PLFSB) \$160</p>
<p>PVC Drain Kit Finishes Chrome included with shower base Brushed Nickel upcharge* (SBDKBN) \$60 Special Finishes upcharge* (SBDKSF) \$295 *Must send finish sample and allow 2 weeks additional lead time.</p>
<p>Drain Kit Options Solid Brass Drain Kit with Stainless Steel Cover (SBDKSB) \$185</p>

Accessories
<p>Shower Niche Matte Finish - White (SSNWHMT) \$480 Gloss Finish - White (SSNWHGL) \$640 Constructed of SculptureStone®</p>
<p>Teak Bath Mat (TKMAT3018) \$430 Measures 30" x 17.5" x 1" Custom sizes also available. Contact MTI for details.</p>
<p>Teak Shower Tray (TK6032SEATED) Contact MTI For Pricing</p>

IMPORTANT ORDERING & INSTALLATION INFORMATION:

- Single, front threshold design with integrated seat.
- 3-sided integral tile flange to facilitate installation. Must specify drain hand on order.
- 3.5" drain opening pre-drilled.
- PVC drain kit included.
- Drain finish options on this sheet are upcharge prices only. Contact MTI for ordering details for drain kits sold separately.
- Compliant with ASTM C 1028-07 coefficient of friction test.
- Measurements are ± 1/2" and are subject to change without notice.
- Data herein supersedes all prior to publication date shown below.

MTI's Customer Service Department is available Monday-Friday 8am-6pm EST at 800.783.8827 or service@mtibaths.com.

