

MBODI6036

59.5" x 35.5" x 18.75"

Installation: Drop-In

Material: Acrylic

Plumbed Weight: 99 lbs / 45 kg

Soaker Weight: 75 lbs / 34 kg

Average Fill: 41 gal to above jet level

Maximum Fill: 62 gal to overflow



Package	Package Content	Part #
Soaker	Soaking bath - No jets. Includes textured bottom.	MBSODI6036
Air Bath	12 air jets, heated air blower, pre-leveled foam base and textured bottom. Pre-leveled foam base increases overall tub height 2"-3"	MBAODI6036
Whirlpool	6 point-massage jets, 1-bhp pump and textured bottom	MBWODI6036

Options Must be ordered at time of purchase.

Standard White (no charge)
Color Upgrade: Biscuit (MTISCOLOR)

Quick Ship / Priority
 Soaker & Whirlpool (QSHIPMTIS)
 Airbath (QSHIPMTISA)

Inline Heater
 For Whirlpool (HTRMTIS) uses existing pump
 For Soaker & Air Bath (MBHTISOAK)
 heater with recirculating pump

Accessories.

Lift and Turn Drain & Overflow
 Chrome (MBWOC), White (MBWOW),
 Brushed Nickel (MBWOBN)

Pillows
 Soft Pillow
 White (MBPSW) Black (MBPSB)
 Roll-Up Pillow
 Light Aqua (MBPRUC) Black (MBRUB)

Installation Options. Must be ordered at time of purchase.

Pre-Leveled Foam Base
 5' Tubs (MBPLFOAM)
 5.5' & 6' Tubs (MBPLFOAM2)
 All airbaths include a pre-leveled foam base.

Shown with Whirlpool Package

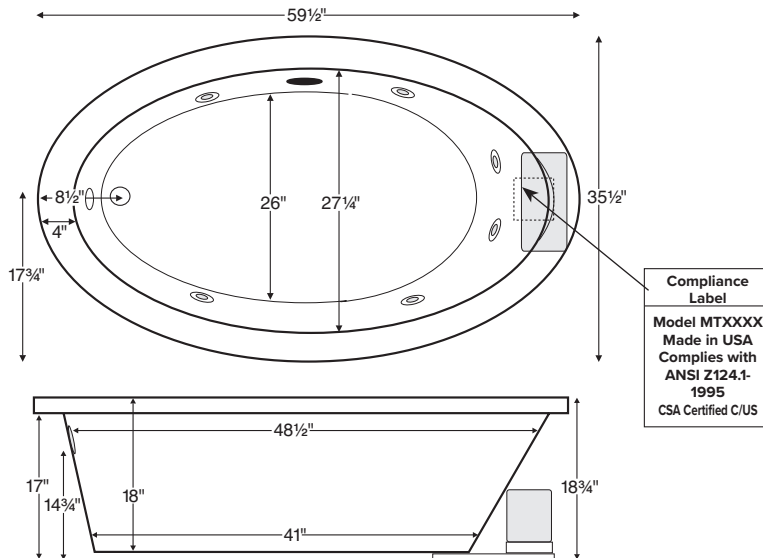

Important Ordering and Installation Information

- Before ordering or installing, consider access to equipment.
- Always measure tub on-site before building tub deck.
- Use proper bedding compound to fully level and support the tub.
- Tubs equipped with an air system or factory installed pre-leveled foam base are designed to install directly onto a flat level subfloor.
- Tub height is increased up to 3" when equipped with factory-installed foam base.
- Location of all therapy components is predetermined and cannot be changed.
- Options listed cannot be combined with Designer Collection options.

• Before discarding tub crate, check for accessories that may be packaged inside.
 • All product measurements are ±1/2".
 • Specifications and configurations are subject to change without notice.
 • Measurements herein supersede all others published prior to publication date below.

CSA # MTIS-ODI6036
 Rev. 12 10 2021

Hydrotherapy Package	Components Included	GFCI / 110V
Soaker with Optional Inline Heater	½-bhp pump, inline heater	1-15 amp
Whirlpool or Air Bath	1-bhp pump	1-15 amp
Whirlpool with Optional Inline Heater	1-bhp pump, inline heater	1-20 amp
Air Bath with Optional Inline Heater	heated blower, ½-bhp pump, inline heater	2-15 amp

CSA Certified C/US; ANSI Z124.1 and ANSI 112.19.7

NOTE: Filling this tub to the maximum may require an above average size or dedicated water heater.

