

# MTI BASICS® Collection Tubs

## MBODI6042

59.5" x 41.5" x 21.75"

Acrylic Drop-In Tub

**Soaker** 75 lbs / 34 kg

**Plumbed** 99 lbs / 45 kg

**Avg Fill** 42 gal to above jet level

**Max Fill** 88 gal to overflow

**NOTE:** Filling this tub to the maximum may require an above average size or dedicated water heater.



Shown with Whirlpool Package

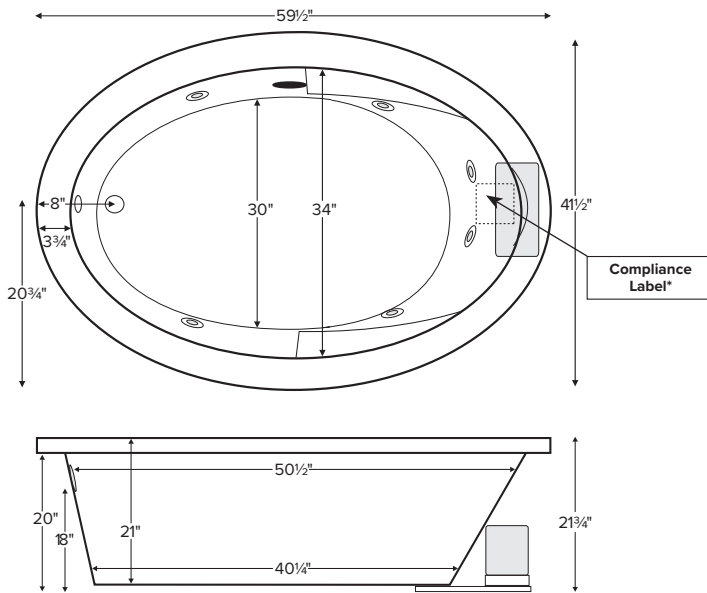

Soaker
Soaking bath - No jets. Includes textured bottom.
<b>Part # MBSODI6042</b>
Air Bath
12 air jets, heated air blower, pre-leveled foam base and textured bottom. Pre-leveled foam base increases overall tub height 2"-3"
<b>Part # MBAODI6042</b>
Whirlpool
6 point-massage jets, 1-bhp pump and textured bottom
<b>Part # MBWODI6042</b>

### Options Must be ordered at time of purchase

**Standard** White (no charge)  
**Color Upgrade:** Biscuit (MTISCOLOR)

**Quick Ship / Priority** call for availability  
 Soaker & Whirlpool (QSHIPMTIS)  
 Airbath (QSHIPMTISA)

**Inline Heater**  
 For Whirlpool (HTRMTIS)  
 uses existing pump  
 For Soaker & Air Bath (MBHTISOAK)  
 heater with recirculating pump

### Accessories

**Lift and Turn Drain & Overflow**  
 Chrome (MBWOC)  
 White (MBWOW)  
 Brushed Nickel (MBWOBN)

**Pillows**  
 Soft Pillow  
 White (MBPSW) Black (MBPSB)  
 Roll-Up Pillow  
 Light Aqua (MBPRUC) Black (MBRUB)

### Installation Aids Must be ordered at time of purchase

**Pre-Leveled Foam Base**  
 5' Tubs (MBPLFOAM)  
 All airbaths include a pre-leveled foam base.

Hydrotherapy Package	Components Included	GFCI / 110V
Soaker with Optional Inline Heater	½-bhp pump, inline heater	1-15 amp
Whirlpool or Air Bath	1-bhp pump	1-15 amp
Whirlpool with Optional Inline Heater	1-bhp pump, inline heater	1-20 amp
Air Bath with Optional Inline Heater	heated blower, ½-bhp pump, inline heater	2-15 amp

### Important Ordering and Installation Information

- Before ordering or installing, consider access to equipment.
- Always measure tub on-site before building tub deck.
- Use proper bedding compound to fully level and support the tub.
- Tubs equipped with an air system or factory installed pre-leveled foam base are designed to install directly onto a flat level subfloor.
- Tub height is increased up to 3" when equipped with factory-installed foam base.
- Location of all therapy components is predetermined and cannot be changed.
- Options listed cannot be combined with Designer Collection options.

\*CSA Certified C/US; ANSI Z124.1 and ANSI 112.19.7

- Before discarding tub crate, check for accessories that may be packaged inside.
- All product measurements are ±1/2".
- Specifications and configurations are subject to change without notice.
- Measurements herein supersede all others published prior to publication revision date.

