



Installation, Operation & Maintenance Manual

iSteam[®] 3 Control

mr.steam[®] | Feel Good Inc.

READ ME FIRST!

!WARNING As you follow these instructions, you will notice warning and caution symbols. This blocked information is important for the safe and efficient installation and operation of this generator. These are types of potential hazards that may occur during installation and operation:

!WARNING Indicates a potentially hazardous situation, which, if not avoided, could result in death or serious injury.

!CAUTION Indicates a potentially hazardous situation, which, if not avoided may result in minor or moderate injury or product damage.

IMPORTANT NOTE: This highlights information that is especially relevant to a problem-free installation.

All information in these instructions is based on the latest product information available at the time of publication. Sussman-Automatic Corporation reserves the right to make changes at any time without notice.

When installing and using this electrical equipment, basic safety precautions should always be followed, including the following:

IMPORTANT SAFETY INSTRUCTIONS

1. READ AND FOLLOW ALL INSTRUCTIONS

2. **!WARNING** Do not permit children under the age of 16 to use this steambath.
3. **!WARNING** Steam is hot and can cause injury or death if improperly used. Steam rooms contain steam and elevated temperatures. Please read and observe all warnings in this manual before installing or using a steam room.
4. **!WARNING** To reduce the risk of injury:
 - A. The wet surfaces of steam enclosures may be slippery. Use care when entering or leaving.
 - B. The steam head is hot. Do not touch the steamhead and avoid the steam near the steamhead.
 - C. Prolonged use of the steam system can raise excessively the internal human body temperature and impair the body's ability to regulate its internal temperature (hyperthermia). Limit your use of steam to 10-15 minutes until you are certain of your body's reaction.
 - D. Excessive temperatures have a high potential for causing fetal damage during the early months of pregnancy. Pregnancy or possibly pregnant women should consult a physician regarding correct exposure.
 - E. Obese persons and persons with a history of heart disease, low or high blood pressure, circulatory system problems, or diabetes should consult a physician before using a steambath.
 - F. Persons using medication should consult a physician before using a steambath since some medication may induce drowsiness while other medications may affect heart rate, blood pressure and circulation.

SAVE THESE INSTRUCTIONS

HYPERTHERMIA occurs when the internal temperature of the body reaches a level several degrees above the normal body temperature of 98.6° F. The symptoms of hyperthermia include an increase in the internal temperature of the body, dizziness, lethargy, drowsiness, and fainting. The effects of hyperthermia include:

- a) Failure to perceive heat;
- b) Failure to recognize the need to exit the steambath;
- c) Unawareness of impending risk;
- d) Fetal damage in pregnant women;
- e) Physical inability to exit the steambath; and
- f) Unconsciousness.

!WARNING

The use of alcohol, drugs, or medication can greatly increase the risk of hyperthermia.

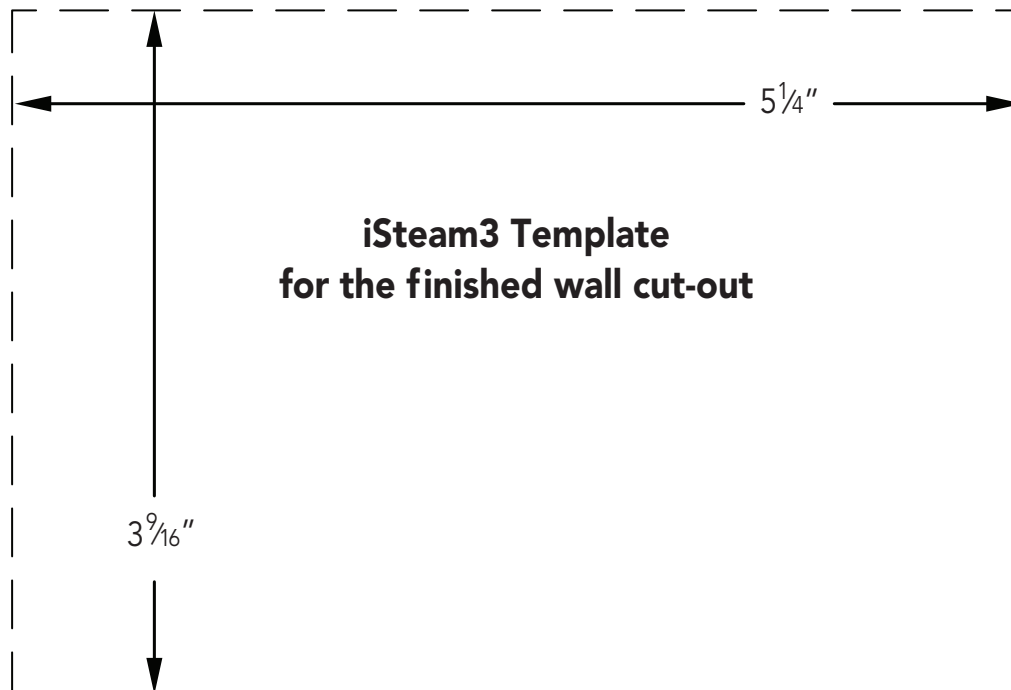

Table of Contents:

Important Safety Instructions.....	2
INSTALLER INFORMATION	
Installation Template	2
Box Content	3
Dimensional Information	3
Before Installing.....	4
Locating the Control.....	5
Installation with Rough-In Box.....	5-6
Installation without Rough-In Box	6
iSteam®3 Installation	7-8
USER/HOMEOWNER INFORMATION	
Operating Instructions	
Stand-By, Start, Dashboard, Set Timer.....	9
Set Temperature, User Settings	10
ChromaSteam®.....	10
AudioSteam, AromaSteam	11
Optional Accessories	11
Settings: System Setting, Date and Time	12
AutoStart, Passcode, About	13
System Log	13
Care Tips, Safety & Operating Info	14
Warranty.....	14

Box Contents:

- iSteam®3 Control
- Control Cable (30 ft.)
- Steamhead
- Tube of Silicone Sealant
- Owner's Manual
- Rough-In Box

Dimensional Information

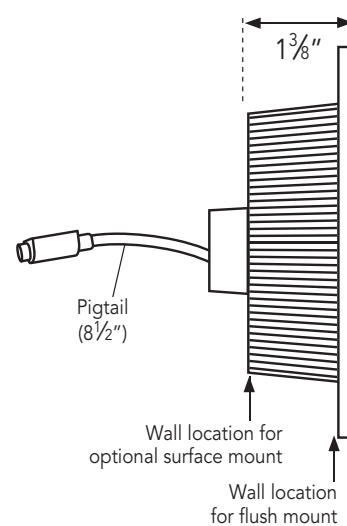
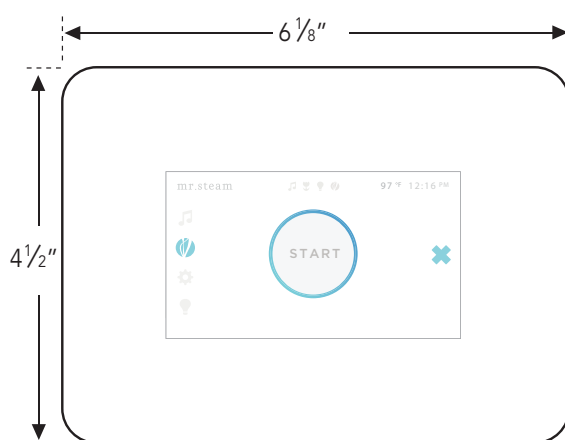

Before Installing

!WARNING To avoid unintentional steambath operation, do not locate the control where other controls, accessories, shower heads, valves, body sprays or similar within the shower could cause confusion or interfere with the MrSteam control's intended use and function.

!CAUTION

- To prevent possible injury Do Not use the iSteam®3 control without reading and understanding the MrSteam steam generator Installation and Operation Manual.
- A peel and stick warning sticker is provided in the MrSteam steam generator Installation, Operation and Maintenance Manual. This manual is provided with every steam generator. The warning sticker must be read and permanently affixed in a conspicuous location near the steam room. Failure to read and affix this warning sticker in a conspicuous location may result in serious injury or death. Please call MrSteam at 800 767-8326 for a free replacement or if you have any questions regarding the warning sticker.

! WARNING	
REDUCE THE RISK OF OVERHEATING AND SCALDING	
<ol style="list-style-type: none"> 1. EXIT IMMEDIATELY IF UNCOMFORTABLE, DIZZY OR SLEEPY. STAYING TOO LONG IN A HEATED AREA IS CAPABLE OF CAUSING OVERHEATING. 2. CHILDREN UNDER THE AGE OF 16 SHOULD NOT USE THE STEAM BATH. 3. CHECK WITH A DOCTOR BEFORE USE IF PREGNANT, DIABETIC, IN POOR HEALTH OR UNDER MEDICAL CARE. 4. BREATHING HEATED AIR IN CONJUNCTION WITH CONSUMPTION OF ALCOHOL, DRUGS, OR MEDICATION IS CAPABLE OF CAUSING UNCONSCIOUSNESS. 5. DO NOT CONTACT STEAM HEAD OR STEAM AT THE STEAM HEAD. 	
REDUCE THE RISK OF SLIPPING AND FALL INJURY	
<ol style="list-style-type: none"> 1. USE CARE WHEN ENTERING OR EXITING THE STEAM ROOM. FLOOR MAY BE SLIPPERY 	
<p>NOTE: FOR ADDITIONAL SAFETY CONSIDERATIONS SEE OWNER'S MANUAL WHICH IS KEPT: _____</p> <p>THE OWNER'S MANUAL CAN BE FOUND AT WWW.MRSTEAM.COM OR BY SCANNING THE QR CODE.</p>	
<p>USE OF STEAM ROOM IN CONJUNCTION WITH CONSUMPTION OF ALCOHOL CAN BE DANGEROUS AND CAN RESULT IN INJURY THROUGH SLIP AND FALL OR OTHERWISE.</p>	
<p>mr.steam® 43-20 34th Street, Long Island City NY 11101 1 800 76 STEAM www.mrsteam.com PUR100378 7/14</p>	

Not actual size

- If an iSteam3 control is installed outside the steam room a Remote Temperature Probe (PN MST5) must be installed inside the steam room per installation instructions supplied with the Remote Temperature Probe. Failure to install according to instructions will result in an inoperative control and overheating of the steam room.

!CAUTION Do not route iSteam3 control wiring inside conduit together with power lines or close to hot water or steam piping. Doing so may result in an inoperative or hazardous installation. Do not alter or modify any Mr. Steam products including the steam generator or iSteam3 control. Doing so may result in an inoperative or hazardous installation and will void the warranty.

IMPORTANT NOTES:

- The iSteam3 Control is designed to be flush mounted. However, the control may be surface mounted when conditions permit. Consult a MrSteam Customer Service or Technical Service representative to determine if the iSteam3 control can be surface mounted.
- Turn power to the steam generator OFF before connecting the control to the generator. Failure to turn the power off will result in an inoperable control.
- Do not operate the iSteam3 control with other than a MrSteam iSteam3 compatible steam generator. MrSteam residential steam generators with serial numbers lower than 1174000, or any other brand of steam generator are not to be operated with iSteam3 controls. Doing so may result in an inoperative installation. If your generator's serial number is lower than 1174000 contact MrSteam Technical Service for upgrade options and components to enable your steam generator to function with iSteam3.
- This document contains important safety, operation and maintenance information. Leave this document with the homeowner. Do not discard this document.
- Discontinue use of the steam generator or control if the steam generator is damaged or otherwise not functioning properly. Doing so may result in an inoperative or hazardous installation
- Refer to the Steambath Generator Installation, Operation and Maintenance Manual for locating and installing the steamhead.

!WARNING Do Not alter or modify any MrSteam products. Doing so may result in an inoperative or hazardous installation and will void the warranty.

Locating the Control

Determine the desired installation location of the control. The iSteam®3 controls are designed to be installed inside or outside the steam room as a matter of personal preference. If the control is installed inside the steam room:

- Locate the control 4-5 feet above the floor near the bather seating area.
- The control features an integral temperature sensor. Locate the control in a location representative of the desired steam bathing temperatures. Do not locate the control above or near the steam head or direct steam emissions.
- Locate the control on a vertical wall.
- The control cable is 30 feet. Insure that the control and steam generator are located accordingly.

IMPORTANT NOTES:

- If required, contact MrSteam to purchase an optional 60' iSteam3 control cable part number 104117-60.
- If the control is installed outside the steam room a Remote Temperature Probe Part Number MSTS must be installed inside the steam room. Refer to the MSTS installation manual before installing the control.
- Insure MrSteam steam generator is iSteam3 compatible and has a serial number 1174000 or higher.

Installation with Optional Rough-In Box

A rough-in box is supplied with iSteam3 for new construction. The rough-in box will allow precise location of the iSteam3 control and provide a secure and easily identifiable place for the cable while the steam room is being constructed.

STEP 1 Take the rough-in box out of the package. Remove the two screws (1a) and place them in the top and bottom wings of the rough-in box (1b).

STEP 2 Select a KNOCK-OUT (2a) to route the control cable into the box.

STEP 3 Line up the two TABS (3a) on the right side of the box against a stud. These TABS help locate the box to sit PROUD of the stud (3b).

STEP 4 SCREW (4a) the two supplied screws into the stud.

STEP 5 Route the CONTROL CABLE (5a) through the back of the rough-in box and clip it under one of the TABS (5b) that previously held the screws. The two ends of the control cable are the same.

IMPORTANT NOTE: The control cable should be run in a dedicated 1" conduit to facilitate installation and service.

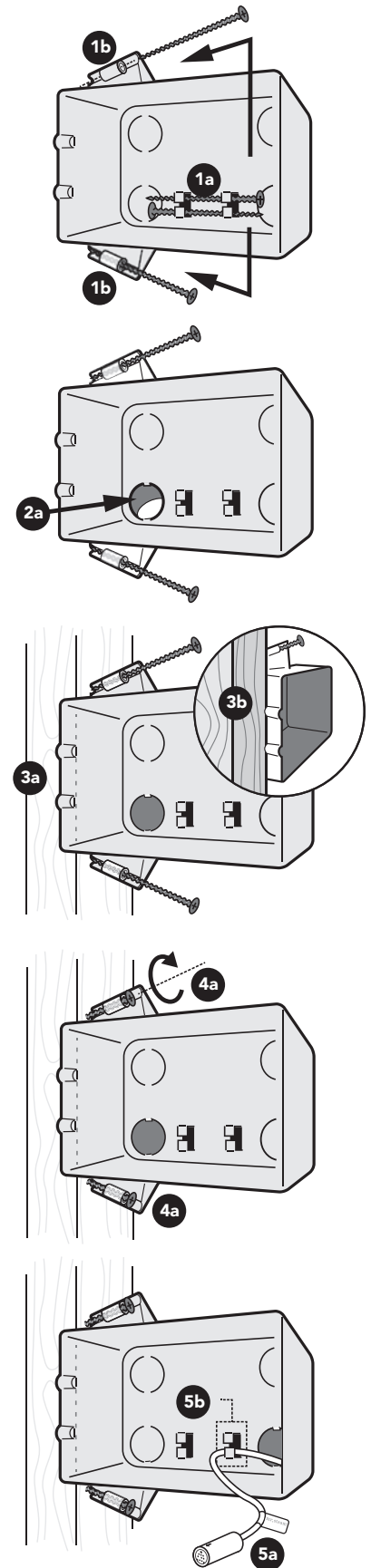

Installation with Optional Rough-In Box (cont.)

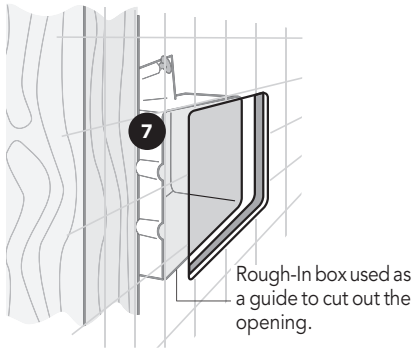

IMPORTANT NOTE: Be careful not to strain, staple, pinch or otherwise damage the cables. Route cables as required to permit replacement. Do not route cables inside conduit together with power lines or close to hot water or steam piping.

STEP 6

Use the rough-in box as a guide to cut out the (3⁹/₁₆" x 5¹/₄") opening in the wall.

Finish the iSteam®3 installation using the instructions on page 7.

Installation without Rough-In Box

STEP 1

Make a 3⁹/₁₆" x 5¹/₄" cut-out in the desired location using the template provided on page 2 of this manual.

STEP 2

Route the control cable from the wall cutout to the steam generator. Connect one end of the cable to the steam generator connector. The two ends of the control cable are the same.

IMPORTANT NOTE: Be careful not to strain, staple, pinch or otherwise damage the control cable. Route cable as required to permit replacement. Do not route cable inside conduit together with power lines or close to hot water or steam piping.

Finish the iSteam3 installation using the instructions on page 7.

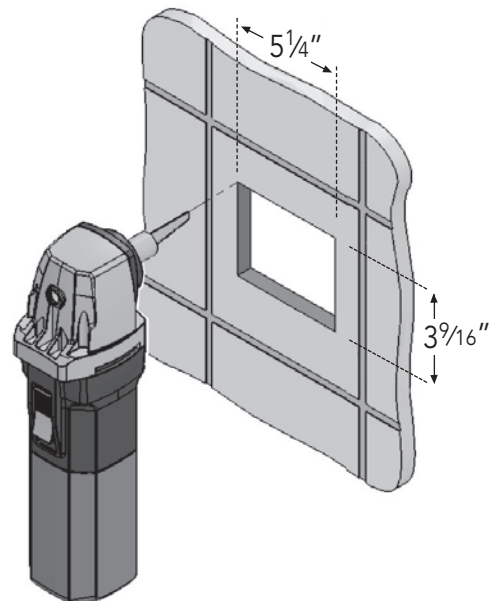

Installation Instructions for iSteam®3

STEP 1

PLUG the 30' control cable into the iSteam3 control pigtail (1a).

Turn the generator on and test the control to verify correct connection. With proper function, proceed to Step 2.

! CAUTION Do not force or twist cable ends together. Forcing or twisting cable ends may damage the connectors.

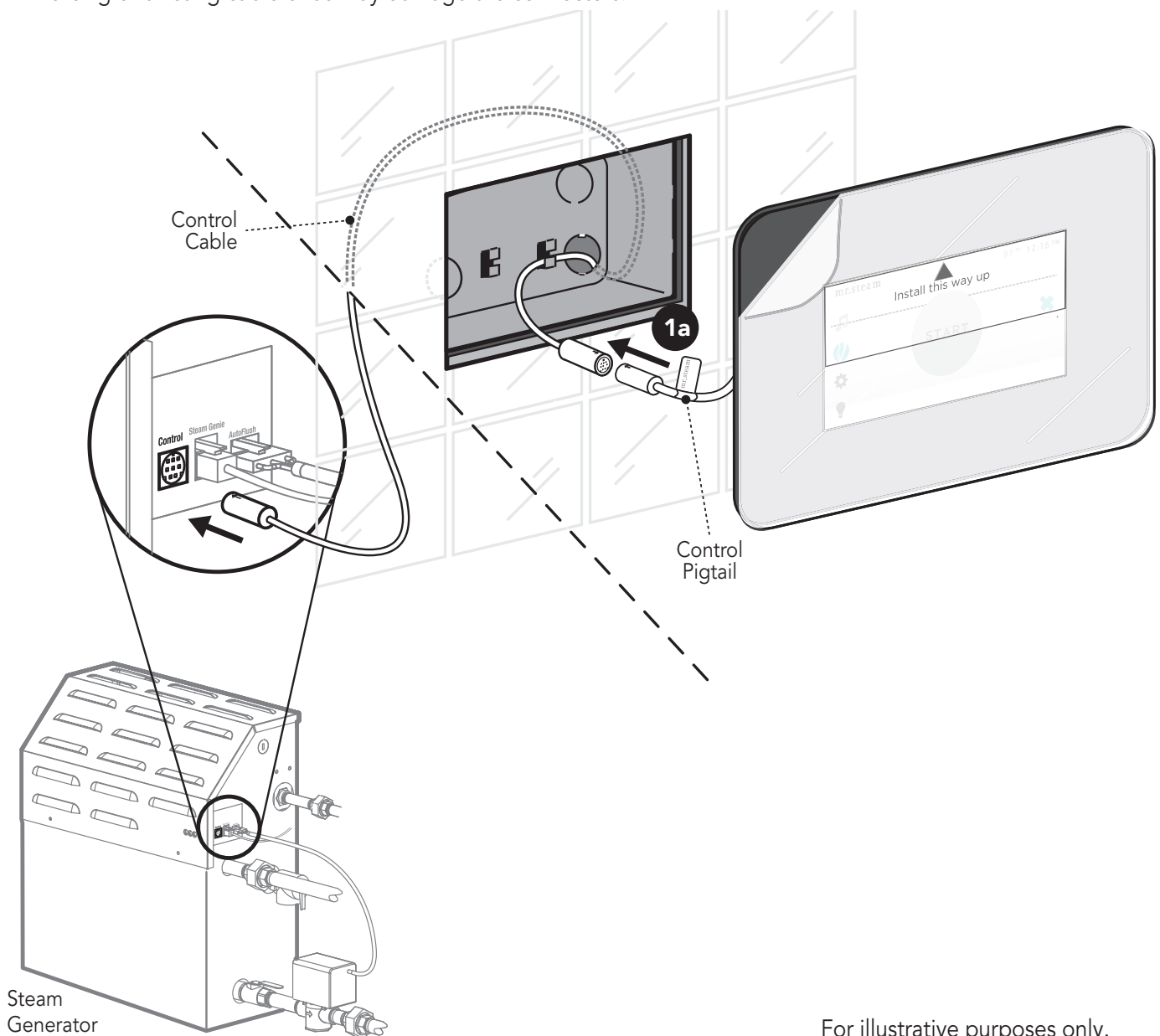

For illustrative purposes only.

Installation Instructions for iSteam®3 (cont.)

STEP 2

Peel the double stick adhesive off the back of the iSteam3 control (2a). Apply a bead of silicone around the rear of the iSteam3 control to create a moisture seal (2b). Carefully feed the cables into the rough-in box and secure the control to the wall. Care must be taken to not pinch the cables. Ensure the control is level.

IMPORTANT NOTE: The control must be installed with the arrow on the Peel-Off screen protector facing up. If the Peel-Off screen protector has been removed see the drawing in Step 2b for the proper orientation. The control display can be flipped 180 degrees in the settings menu if installed upside down.

NOTE: The silicone supplied by MrSteam can be used to meet a variety of sealing and gasketing. It cures to silicone rubber and adheres to glass, wood, metal, porcelain, ceramic tile, painted surfaces, many plastics and rubber. Surfaces must be clean and dry. Apply thin layer of product. Fit together and support if necessary. Allow excess material to cure, then trim with a sharp blade. Sealant "skins" in 5 minutes, dries to touch in 1 hour. Fully cures and bonds in 24 hrs.

IMPORTANT NOTE: Do not apply excessive amounts of silicone. Do not apply silicone to any other parts of the control including the adhesive gasket. Insure the mounting surface is clean and dry as required for good adhesion. Hold the control with the arrow on the screen protector facing up and press the control against the wall until the adhesive sticks and holds firmly. Control may have to be supported or secured until the silicone has cured for 24 hours.

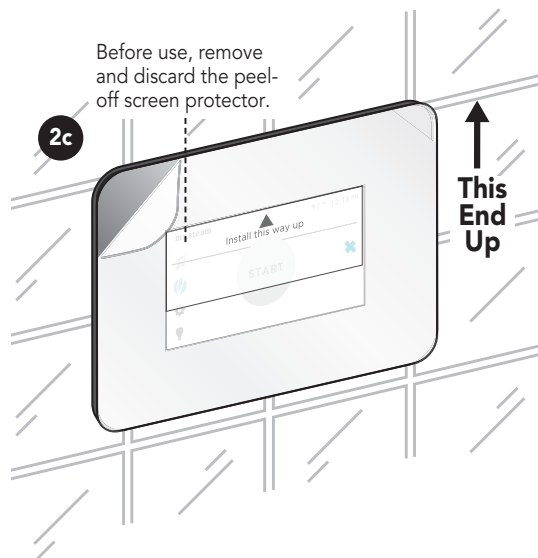
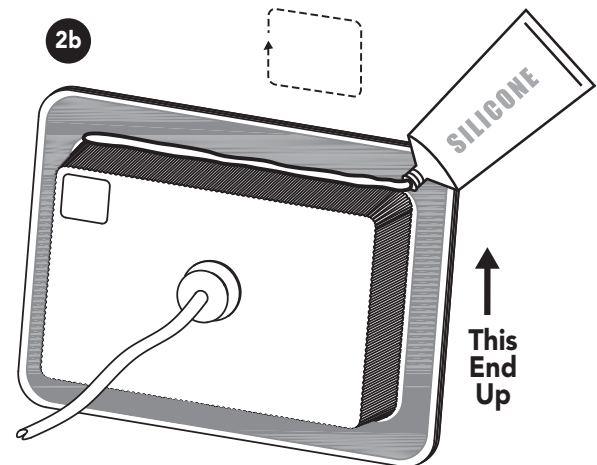
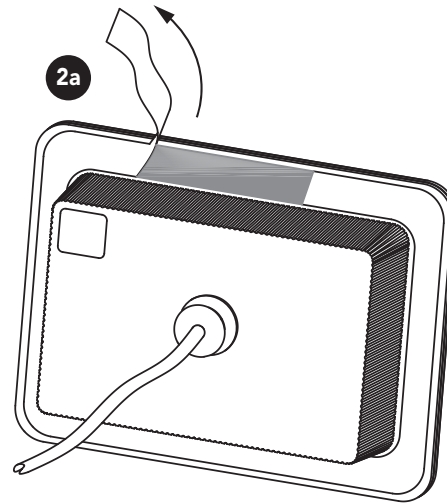

READ ME FIRST!

! WARNING As you follow these instructions, you will notice warning and caution symbols. This blocked information is important for the safe and efficient installation and operation of this generator. These are types of potential hazards that may occur during installation and operation:

! WARNING Indicates a potentially hazardous situation, which, if not avoided, could result in death or serious injury.

! CAUTION Indicates a potentially hazardous situation, which, if not avoided may result in minor or moderate injury or product damage.

IMPORTANT NOTE: This highlights information that is especially relevant to a problem-free installation.

All information in these instructions is based on the latest product information available at the time of publication. Sussman-Automatic Corporation reserves the right to make changes at any time without notice.

When installing and using this electrical equipment, basic safety precautions should always be followed, including the following:

IMPORTANT SAFETY INSTRUCTIONS

1. READ AND FOLLOW ALL INSTRUCTIONS

2. **! WARNING** Do not permit children under the age of 16 to use this steambath.
3. **! WARNING** Steam is hot and can cause injury or death if improperly used. Steam rooms contain steam and elevated temperatures. Please read and observe all warnings in this manual before installing or using a steam room.
4. **! WARNING** To reduce the risk of injury:
 - A. The wet surfaces of steam enclosures may be slippery. Use care when entering or leaving.
 - B. The steam head is hot. Do not touch the steamhead and avoid the steam near the steamhead.
 - C. Prolonged use of the steam system can raise excessively the internal human body temperature and impair the body's ability to regulate its internal temperature (hyperthermia). Limit your use of steam to 10-15 minutes until you are certain of your body's reaction.
 - D. Excessive temperatures have a high potential for causing fetal damage during the early months of pregnancy. Pregnancy or possibly pregnant women should consult a physician regarding correct exposure.
 - E. Obese persons and persons with a history of heart disease, low or high blood pressure, circulatory system problems, or diabetes should consult a physician before using a steambath.
 - F. Persons using medication should consult a physician before using a steambath since some medication may induce drowsiness while other medications may affect heart rate, blood pressure and circulation.

SAVE THESE INSTRUCTIONS

HYPERTHERMIA occurs when the internal temperature of the body reaches a level several degrees above the normal body temperature of 98.6° F. The symptoms of hyperthermia include an increase in the internal temperature of the body, dizziness, lethargy, drowsiness, and fainting. The effects of hyperthermia include:

- a) Failure to perceive heat;
- b) Failure to recognize the need to exit the steambath;
- c) Unawareness of impending risk;
- d) Fetal damage in pregnant women;
- e) Physical inability to exit the steambath; and
- f) Unconsciousness.

! WARNING The use of alcohol, drugs, or medication can greatly increase the risk of hyperthermia.

! WARNING The peel and stick warning label located in the steam bath generator manual is an essential part of providing a safe environment for steam room users. The peel and stick warning label must be applied to the wall of the shower or steam enclosure, at a point that is visible to all users. Failure to install this sticker may result in serious injury or death.

The location where this owner's manual is kept shall be written in the space provided on the label using permanent ink.

For a replacement warning label contact MrSteam customer service at 1-800-76-STEAM or hello@mrsteam.com

 WARNING
<p>REDUCE THE RISK OF OVERHEATING AND SCALDING</p> <ol style="list-style-type: none"> 1. EXIT IMMEDIATELY IF UNCOMFORTABLE, DIZZY OR SLEEPY. STAYING TOO LONG IN A HEATED AREA IS CAPABLE OF CAUSING OVERHEATING. 2. CHILDREN UNDER THE AGE OF 16 SHOULD NOT USE THE STEAM BATH. 3. CHECK WITH A DOCTOR BEFORE USE IF PREGNANT, DIABETIC, IN POOR HEALTH OR UNDER MEDICAL CARE. 4. BREATHING HEATED AIR IN CONJUNCTION WITH CONSUMPTION OF ALCOHOL, DRUGS, OR MEDICATION IS CAPABLE OF CAUSING UNCONSCIOUSNESS. 5. DO NOT CONTACT STEAM HEAD OR STEAM AT THE STEAM HEAD.
<p>REDUCE THE RISK OF SLIPPING AND FALL INJURY</p> <ol style="list-style-type: none"> 1. USE CARE WHEN ENTERING OR EXITING THE STEAM ROOM. FLOOR MAY BE SLIPPERY
<p>NOTE: FOR ADDITIONAL SAFETY CONSIDERATIONS SEE OWNER'S MANUAL WHICH IS KEPT: _____</p> <p>THE OWNER'S MANUAL CAN BE FOUND AT WWW.MRSTEAM.COM</p>
<p>USE OF STEAM ROOM IN CONJUNCTION WITH CONSUMPTION OF ALCOHOL CAN BE DANGEROUS AND CAN RESULT IN INJURY THROUGH SLIP AND FALL OR OTHERWISE.</p>
<p>mr,steam® 43-20 34th Street · Long Island City, NY 11101 1 800 76 STEAM · www.mrsteam.com PUR100378 7.14</p>

Not actual size.

Operating Instructions

!WARNING Set the steam bathing duration and temperature according to personal preference, however it is highly recommended to begin steam bathing at a low temperature setting to gauge comfort and safety levels. Set the duration at 10 minutes max. to gauge comfort and safety levels. This will allow the steam generator to heat up and begin producing steam.

Stand-By Screen

Touch anywhere on the clock screen to enter the Start Screen.

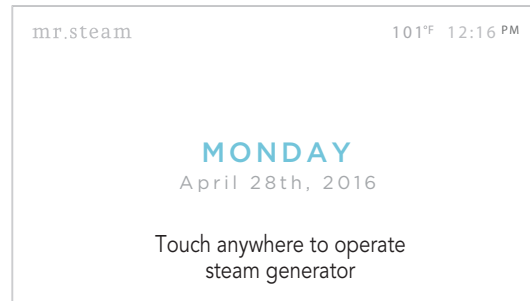
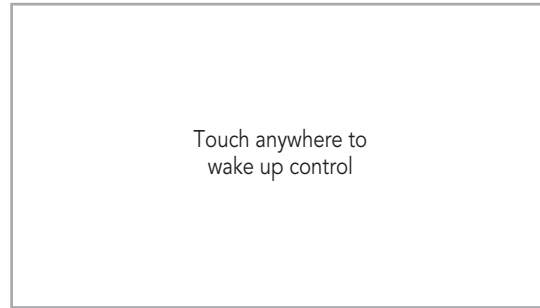

Start Screen

Press the START button to turn the steam generator ON and to display the Dashboard screen. Steam will begin to flow a few minutes after the START button is pressed. The time required for the steam room to reach steam bathing temperatures depends on the steam room construction and steam generator specifications.

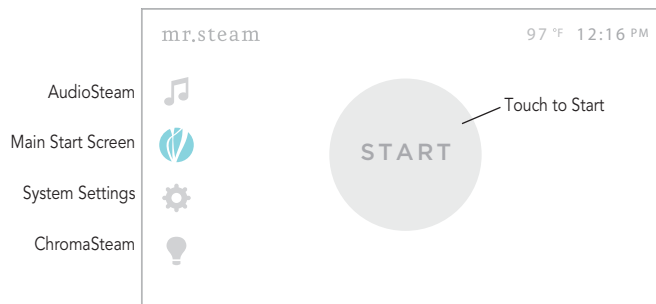

Dashboard Screen

The Dashboard displays key steam bathing features and optional accessories in one convenient screen. The key features include TIME, TEMPERATURE and USER settings. The optional accessories include the ChromaSteam®, AromaSteam and AudioSteam.

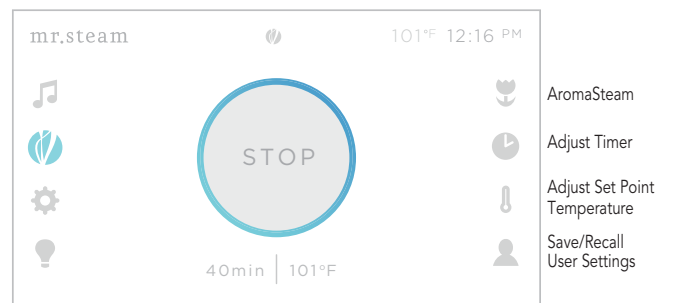

Set Timer Screen

Press the TIMER button on the Dashboard to access the SET TIMER screen. Swipe your finger up/down to select the desired time (1-60 minutes). The control will turn off when the steambath session times out. Then the START screen will be displayed.

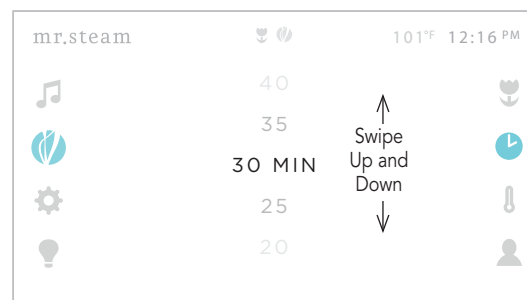

Set Temperature Screen

Press the TEMPERATURE button on the Dashboard to access the SET TEMPERATURE screen.

The control is preset and will display a temperature setting of 110°F (default setting). Swipe your finger up and down to adjust the desired temperature (80° - 120° F) in one degree increments.

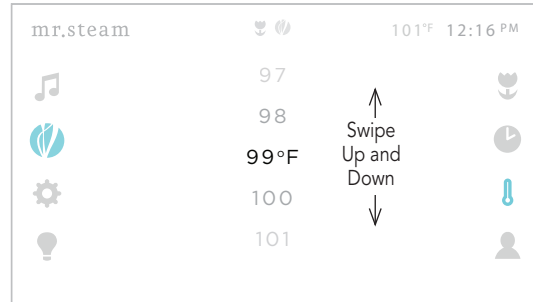

User Settings

Press the SAVE/RECALL user settings button.

To save the settings press the SAVE CURRENT SETTINGS button. A keyboard will pop up where the user name can be entered.

To recall the user settings press the user's name.

To remove the settings press the delete icon.

A maximum of 8 user settings can be saved.

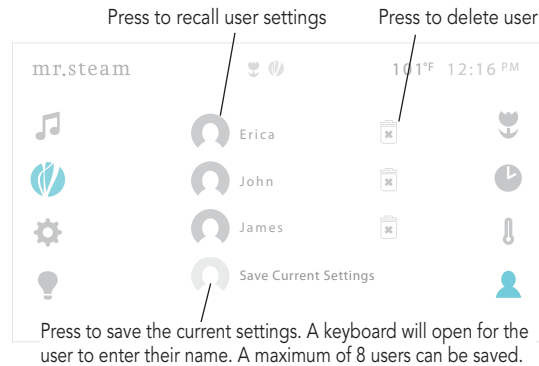

ChromaSteam®

The ChromaSteam is an optional accessory that activates colored lights in the steam room. Press the CHROMA button to turn it ON. When ChromaSteam is on, press the CHROMA button to turn it off.

Press the ChromaSteam Dashboard button to bring up the color wheel. Touch anywhere on the wheel to select that color. To adjust the brightness, use the slider on the bottom of the ChromaSteam Dashboard. The slider will change color to show current color selection. (Note: Brightness cannot be adjusted in automatic color changing modes)

Press the Discrete Color Selection button to pick a preselected list of colors, have white light, or slow or fast changing color modes.

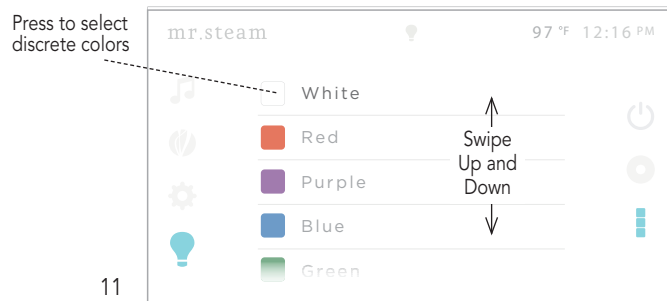
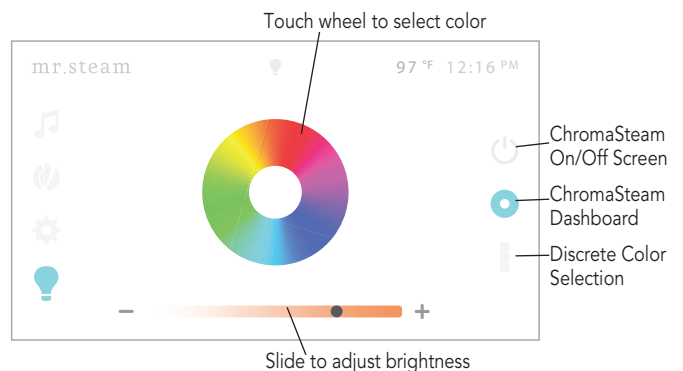
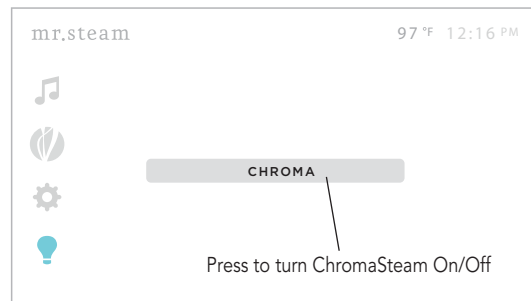





AudioSteam

Press the music icon  to access the AudioSteam screen.

Press the MUSIC button to turn on AudioSteam.

When AudioSteam is ON, pressing the MUSIC button will turn it OFF.

Press the AudioSteam Dashboard button to control the music. When paired to a Bluetooth® device, iSteam®3 will display the song title, artist and album name. If listening to the FM radio, the station number will be shown. This space is blank if playing music from a hard wired source.

-  Mute
-  Previous Track or scan backwards when in FM mode
-  Play/Pause (Bluetooth only)
-  Next Track or scan backwards when in FM mode

If you are using a Bluetooth audio source, it must be connected for functions to work. Please refer to the Bluetooth pairing instructions in the AudioSteam IOM.

Press the Source button to select hardwired AUX source, Bluetooth source or the FM radio. To unpair the current connected Bluetooth device, press the DISCONNECT button.

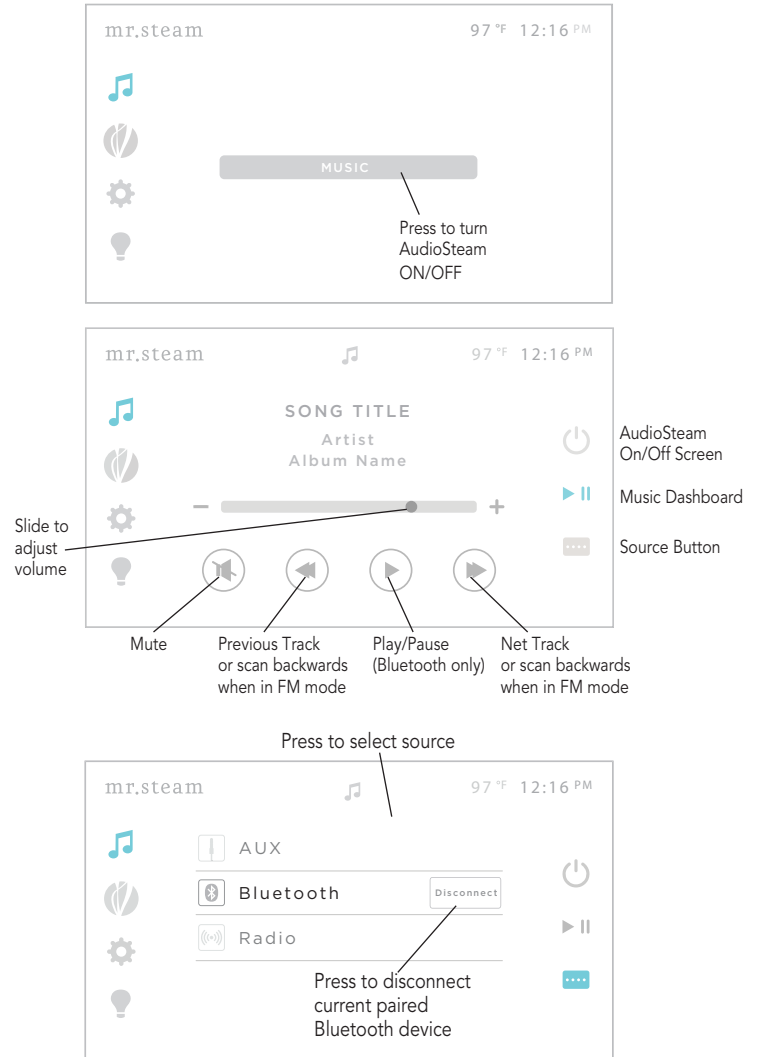

AromaSteam

The AromaSteam is optional accessory that automatically infuses aromatic oils into the steam flow. Press the AromaSteam icon to bring up the AromaSteam Dashboard. Press the AROMA button to turn it ON.

The AromaSteam turns OFF automatically when the steam generator stops.

Press the AROMA button to turn it OFF during a steam session.

After the steam session has ended the AudioSteam and ChromaSteam® will remain ON. They can be turned OFF individually by navigating to each's power button, or both can be turned OFF by pressing the OFF icon that appears on the START screen.

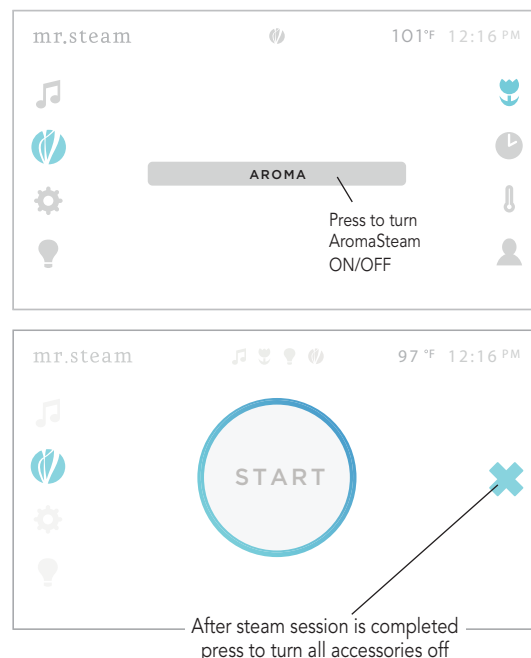



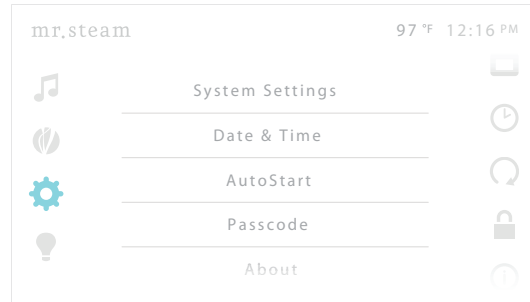

Settings Screen

The Setting Screen allows access to less frequently used screens.



System Setting

Scroll through the System Settings list and select which to adjust.

-  Temperature Units. Adjust between °F and °C
-  Flip Screen. Rotates the screen 180° in case the control was installed upside down
-  User Interface Color: Toggle between a white and black background
-  Brightness: Adjust the screen brightness
-  Language: Change the language used in the user interface

Once the setting is changed, press the System Setting button in the menu on the right to exit

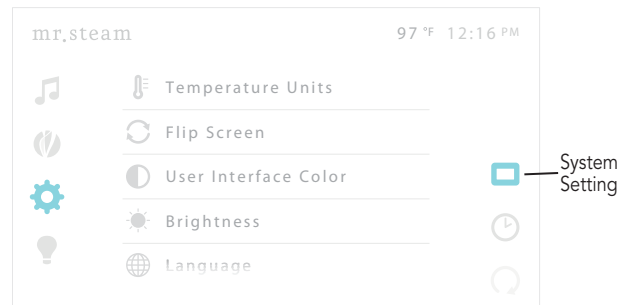

Date and Time

Scroll up and down to select the date and time. Once selected, press the Set Date and Time button in the menu on the right to exit



AutoStart

!WARNING AutoStart will automatically turn the steam generator on at your preset time. Activating the steam in an occupied room may subject persons to the hazards described in this manual. Only activate the steambath if the steam room door is closed. Activating or using the steambath with an open door may cause property damage or injury to persons outside of the steam bath.

The AutoStart feature can be used to turn on the steambath at a predetermined time. Select the day(s) of the week and the time of day you would like to turn the steam bath on.

When AutoStart starts your steambath it will allow the steambath to run for only 10 minutes. To continue steam bathing press the continue button. If the continue button is pressed, AutoStart will remain active for the next scheduled start time.

To stop the steam bath press the STOP button.

If the STOP button or 10 minute time out turns the steam generator off, AutoStart will automatically be deactivated.

To create an AutoStart time, press the **+** icon. Select the start time to adjust the day and time for AutoStart. A maximum of 8 start times can be programmed. To delete a start time, press the trash can icon.

To turn AutoStart ON, press the AutoStart button above the start time list.

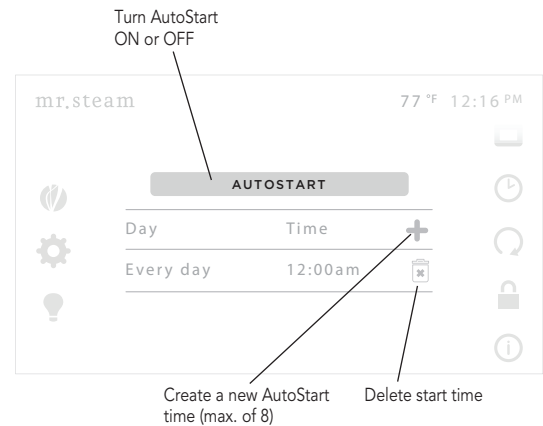

Passcode

The Passcode feature can help prevent unintentional use of the steambath. Please refer to the steam generator Installation, Operation and Maintenance manual before using the steambath. The Passcode feature cannot insure unintentional use of the steambath.

To turn the Passcode lock ON or OFF, press the lock icon.

Enter a 4 digit passcode using the keypad. Press the entire button to SAVE the passcode. The next time the iSteam3 control is turned on the user will be prompted to enter the passcode. Press the Back button to exit without storing the passcode lock.

If you forget your passcode, power should be turned off at the circuit breaker. After 1 minute turn the breaker back on. The passcode lock will automatically be turned OFF.

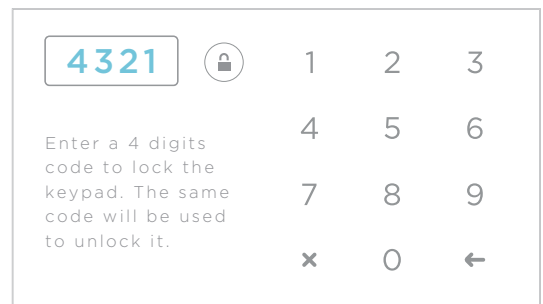

About Screen

Press ABOUT to view the accessories connected to the steam generator.

System Log

Press SYSTEM LOG to view an error log created by the steam generator.

!WARNING To prevent injury and/or equipment damage all troubleshooting is to be performed by qualified licensed electrician or plumber. Contact MrSteam technical support at 1-800-727-8326 (East coast) or 1-800-727-8326 (West coast) in the event that iSteam®3 displays an error code.

Care Tips

Use only mild soap and water on a soft cloth to clean the control. Do not use abrasive cleansers.

Safety and Operating Information

!WARNING A peel and stick warning sticker is provided in the MrSteam steam generator Installation, Operation and Maintenance Manual. This manual is provided with every steam generator. The warning sticker must be read and permanently affixed in a conspicuous location near the steam room. Failure to read and affix this warning sticker in a conspicuous location may result in serious injury or death. Please call MrSteam at 800 767-8326 for a free replacement or if you have any questions regarding the warning sticker.

!WARNING Set the steam bathing duration and temperature according to personal preference, however it is highly recommended to begin steam bathing at a low temperature setting to gauge comfort and safety levels. Set the duration at 10 minutes max. to gauge comfort and safety levels. This will allow the steam generator to heat up and begin producing steam.

!CAUTION Do not use any iSteam®3 control without reading and understanding the MrSteam steam generator Installation and Operation Manual (PN 100472). Failure to read and understand these instructions may result in an inoperative or hazardous installation.

!CAUTION If an iSteam3 control is installed outside the steam room a Remote Temperature Probe (PN MST5) must be installed inside the steam room per installation instructions supplied with the Remote Temperature Probe. Failure to install according to instructions will result in an inoperative control and overheating of the steam room.

Warranty

To view or download the MrSteam Control Warranty and register your product go to: [**blog.mrsteam.com/wr**](http://blog.mrsteam.com/wr)

mr.steam®

Feel Good Inc.®

www.mrsteam.com

Products, information and specifications are subject to change without notice. For more information call Sales & Support at 1.800.76.STEAM (East Coast) or 1.800.72.STEAM (West Coast) for more information.

mr.steam® Sussman-Automatic Corporation® | hello@mrsteam.com | www.mrsteam.com
43-20 34th Street, Long Island City, NY 11101 | 9410 S. La Cienega Blvd. Inglewood CA 90301
1 800 767 8326 FAX: 718 472 3256 | 1 800 72 STEAM FAX: 310 216 2944

2017 © Sussman-Automatic Corporation | MrSteam and des., A Lifetime of Pleasure, AirTempo, AromaFlo, AudioWizard, AutoFlush, Butler Package, ChromaSteam, Clean Steam...Every Time, Club Therapy, Digital 1, Express Steam, Feel Good Inc., From Bathroom to Spa, iButler, iGenie, iSizing, iSteam, Making Wellness a Way of Life, Music Therapy, Spa Package, Steam on Demand, Steam@Home, iTempo, iTempo/Plus, SmartSizing, SteamStart, SteamStop, SteamTherapy, Sussman, Tala, Bath & Body Therapy, The Intelligent Steambath, Valet Package, Virtual Spa System, Voice Genie and Voice Wizard are registered trademarks of Sussman-Automatic Corporation.

PUR 100514 REV 7.17