

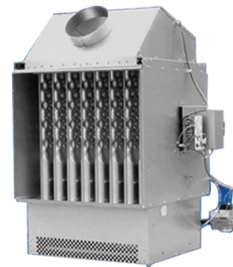

# COMMERCIAL & INDUSTRIAL UNITARY HEATING PRODUCTS

GAS  
STEAM/HOT WATER  
OIL  
ELECTRIC



# MODINE COMMERCIAL & INDUSTRIAL UNIT HEATERS

Modine has always been the industry standard for comfort heating applications. With the Modine product line, you can fulfill your unit heater application needs with a variety of energy sources.

## Natural or Propane Gas • Steam/Hot Water • Oil • Electric

Modine sales representatives are experienced specialists in the engineering, selection and application of Modine commercial and industrial heating and ventilating equipment. Located near you, these representatives can help you satisfy your comfort needs and indoor-air quality requirements. Contact your Modine product source for assistance in providing top-quality, high-efficiency Indoor Air Solutions.

**Direct Fired Rooftop**  
For buildings that require significant make-up air; wide performance capabilities; 100% efficient

**Indirect Fired Rooftop (WeatherHawk)**  
For buildings that require significant space heating and/or make-up air; wide performance capabilities

**Packaged Rooftop Ventilation**  
Cools, dehumidifies and heats outside air to meet ASHRAE 189.1 and 62.1

**Gas Fired Unit Heater<sup>®</sup>**  
Certified for commercial applications; ideal for factories, warehouses, greenhouses; steady temps and air circulation

**Electric Unit Heater<sup>®</sup>**  
Horizontal (low ceilings), vertical (high ceilings), and Power Throw<sup>™</sup> available; uniform heating, reduced maintenance

**Steam/Hot Water Unit Heater<sup>®</sup>**  
Ideal for commercial and industrial apps; horizontal and vertical throw available; low cost and easy installation

**Oil Fired Unit Heater<sup>®</sup>**  
Optimum comfort and heating efficiency; long-life, corrosion resistant heat exchanger; easy to install and service

**Cabinet Unit Heater**  
Ideal for independent heating zones; flexible control and configuration options; steam/hot water heating source

**Convactor**  
Maximum installation flexibility; can be recessed, wall hung and free standing; steam/hot water heating source

**Fin Tube Radiation**  
Variety of styles and enclosures to meet any architectural style; steam/hot water heating source

**Cassette**  
Ductless cooling; zone controlled for better efficiency; low equipment/installation costs; space-saving

**Duct Furnace**  
Supplies heat to an air stream provided by other equipment; ideal for make-up air

**High Intensity Infrared<sup>®</sup>**  
Spot heating for objects (not air); quiet, clean; no air movement or duct work; quick temp. recovery

**Low Intensity Infrared<sup>®</sup>**  
Spot- or area-heating for objects (not air) in larger environments such as high ceilings, near open doors and loading docks

**Geothermal HVAC units**  
water-to-water, water-to-air, and water/air combo systems

**Residential Gas Fired/Hot Water Unit Heater<sup>®</sup>**  
Residential certified; ideal for small garages through large out-buildings

① Products as noted can be found in the latest revision of 75-137, Commercial & Industrial Applied Products

# UNITARY HEATING PRODUCTS - TABLE OF CONTENTS



CONTENTS	PAGE
<b>Gas-Fired Unit Heaters, Indoor Duct Furnaces, Infrared Heaters</b>	
Power-Exhausted .....	4
Separated Combustion .....	5
Separated Combustion, High-Efficiency Condensing .....	6-7
Blower Models .....	8
Indoor Duct Furnaces .....	9
High-Intensity Infrared Heaters .....	10
High Intensity Patio Heaters .....	11
Low-Intensity Pressurized Infrared Heaters .....	12
<b>Steam/Hot Water Unit Heaters</b>	
Hot Dawg H <sub>2</sub> O® - Low Profile Hot Water Unit Heater .....	13
Horizontal Delivery .....	14
Vertical Delivery .....	15
<b>Oil-Fired Unit Heaters</b>	
Horizontal Delivery .....	16
<b>Electric Unit Heaters</b>	
Horizontal and Vertical Delivery .....	17
Horizontal Delivery for Hazardous Locations .....	18
Modine Breeze® AccuSpec Sizing and Selection Program .....	19

# GAS-FIRED, POWER-EXHAUSTED

- 82% Thermal Efficiency • Horizontal or Vertical Venting • Field Convertible to Propane • 100% Shut-Off with Continuous Retry • Commercial or Residential Applications



**MODEL HD**



**MODEL PDP**



**MODEL PTP**

For applications requiring a low profile unit, Modine offers the Hot Dawg® unit heater. The Hot Dawg® may be installed in residential or commercial applications just one inch below the ceiling. The superior quality matched with the following features makes the Hot Dawg® unit heater an easy choice for a variety of applications:

- 82% thermal efficiency for fuel savings.
- Uses natural or propane gas (field convertible from natural to propane gas).
- Certified for residential, commercial and industrial use.
- Lightweight, easily installs 1" from ceiling with only two angle brackets (standard on 30-75, accessory for 100-125).
- Install quickly and easily with knockouts for quick access to gas and electricity.
- The standard power exhauster allows the unit to be vented vertically or horizontally and is designed to use the smallest diameter vent pipe possible.
- Permanently-lubricated motor for trouble-free dependability.
- Full 10-year warranty on heat exchanger.
- Available in both propeller fan and centrifugal blower configurations.

The PDP (propeller) power vented gas-fired unit heater is a product that is inexpensive to install, easy to use, and offers excellent in-service economy. The PDP model series expands on the size range of the HD model series providing product that is certified for commercial and industrial applications in sizes from 150 through 400MBH.

For blower model data, see page 8.

**Table 4.1 - Propeller Unit Model HD and PDP General Performance Data**

	Model HD Sizes						Model PDP Sizes						
	30	45	60	75	100	125	150	175	200	250	300	350	400
Btu/Hr Input ①	30,000	45,000	60,000	75,000	100,000	125,000	150,000	175,000	200,000	250,000	300,000	350,000	400,000
Btu/Hr Output ①	24,600	36,900	49,200	61,500	82,000	102,500	123,000	143,500	164,000	205,000	246,000	287,000	328,000
Entering Airflow (CFM) @ 70°F	505	720	990	1160	1490	1980	2180	2550	2870	3700	4460	4870	5440
Air Temp. Rise (°F)	44	46	45	48	50	47	51	51	52	50	50	53	54
Max. Mounting Height (Ft.) ②	10	10	12	14	12	16	16	17	15	19	21	20	19
Heat Throw (Ft.) @ Max Mtg Ht ②	25	27	36	38	42	56	55	59	51	67	74	70	69

The PTP features a stainless steel tubular heat exchanger as STANDARD on all units with a 10-year heat exchanger warranty, providing customers with a peace of mind. Users of the PTP will also benefit from a design that allows quick and easy installations.

**Table 4.2 - Propeller Unit Model PTP General Performance Data**

	Model PTP Sizes						
	150	175	200	250	300	350	400
Btu/Hr Input ①	150,000	175,000	200,000	250,000	300,000	350,000	400,000
Btu/Hr Output ①	123,000	143,500	164,000	205,000	246,000	287,000	328,000
Entering Airflow (CFM) @ 70°F	2140	2725	2870	3995	4545	5280	5995
Air Temp. Rise (°F)	53	48	52	47	50	50	51
Max. Mounting Height (Ft.) ②	15	14	15	18	19	18	21
Heat Throw (Ft.) @ Max Mtg Ht	51	50	53	62	69	65	74

① Ratings shown are for elevations up to 2,000 Ft. For elevations above 2,000 feet, ratings should be reduced at the rate of 4% for each 1,000 feet above sea level. (In Canada see rating plate.) Reduction of ratings requires use of a high altitude kit.

② Data taken at 55°F air temperature rise. At 65°F ambient and unit fired at full-rated input. Mounting height as measured from bottom of unit, and without deflector hoods. For units equipped with deflector hoods.

**DO NOT LOCATE ANY GAS-FIRED UNIT IN AREAS WITH CHLORINATED, HALOGENATED, OR ACIDIC VAPORS IN ATMOSPHERE.**

Request Catalog 6-189 For Complete Technical Information and Specifications.





# GAS-FIRED, SEPARATED COMBUSTION

- 100% Outside Air for Combustion • Sealed Compartment Protects Combination Gas Control, Ignition Control, Manifold and Burner • Horizontal or Vertical Concentric Venting • 82% Thermal Efficiency • Direct Spark Ignition
- 100% Shut-Off with Continuous Retry • Certified for Commercial or Residential Applications

The separated combustion models HDS/HDC and PTS/BTS draw 100% of their combustion air from outside to ensure that the unit will always have plenty of fresh, clean air to breathe. This fresh-air supply reduces common concerns about maintenance, performance, and durability in dusty, dirty, or humid applications. In addition, by drawing the combustion air from the outside, the overall heating efficiency is increased. In short, the separated combustion units give you the added advantages of:

- 82% thermal efficiency for fuel savings.
- A sealed compartment protects the combination gas valve, ignition control, manifold, and burner from the environment.
- External gas connections.
- Uses natural or propane gas (field convertible from natural to propane gas).
- Certified for residential (30-125MBH), commercial and industrial use (30-400MBH).
- Lightweight, easily installs 1" from ceiling with only two angle brackets (standard on 30-75, accessory for 100-125).
- Install quickly and easily with knockouts for quick access to gas and electricity.
- Standard power exhaust simplifies side-wall or roof venting with small-diameter vent pipe.
- Horizontal or vertical two-pipe or concentric venting options.
- Permanently-lubricated motor for trouble-free dependability.
- Full 10-year warranty on heat exchanger.
- Available in both propeller fan and centrifugal blower configurations.

For blower model data, see page 8.

**Table 5.1 - Propeller Unit Model HDS and PTS General Performance Data**

	Model HDS Sizes						Model PTS Sizes						
	30	45	60	75	100	125	150	175	200	250	300	350	400
<b>Btu/Hr Input</b> ①	30,000	45,000	60,000	75,000	100,000	125,000	150,000	175,000	200,000	250,000	300,000	350,000	400,000
<b>Btu/Hr Output</b> ①	24,600	26,900	49,200	61,500	82,000	102,500	123,000	143,500	164,000	205,000	246,000	287,000	328,000
<b>Entering Airflow (CFM) @ 70°F</b>	505	720	990	1160	1490	1980	2140	2725	2870	3995	4545	5280	5995
<b>Air Temp. Rise (°F)</b>	44	46	45	48	50	47	53	48	52	47	50	50	51
<b>Max. Mounting Height (Ft.)</b> ②	10	10	12	14	12	16	15	14	15	18	19	18	21
<b>Heat Throw (Ft.) @ Max Mtg Ht</b> ②	25	27	36	38	42	56	51	50	53	62	69	65	74

① Ratings shown are for elevations up to 2,000 Ft. For elevations above 2,000 feet, ratings should be reduced at the rate of 4% for each 1,000 feet above sea level. (In Canada see rating plate.) Reduction of ratings requires use of a high altitude kit.

② Data taken at 55°F air temperature rise. At 65°F ambient and unit fired at full-rated input. Mounting height as measured from bottom of unit, and without deflector hoods.



**MODEL HDS**



**MODEL HDC**



**MODEL PTS**



**DO NOT LOCATE ANY GAS-FIRED UNIT IN AREAS WITH CHLORINATED, HALOGENATED, OR ACIDIC VAPORS IN ATMOSPHERE.**

Request Catalog 6-175 For Complete Technical Information and Specifications.

# GAS-FIRED, SEPARATED COMBUSTION, HIGH-EFFICIENCY CONDENSING

- 100% Outside Air for Combustion • Sealed Compartment Protects Combination Gas Control, Ignition Control, Manifold and Burner • Conservicore® Secondary Heat Exchanger • Horizontal or Vertical Concentric Venting
- 93% Thermal Efficiency • Direct Spark Ignition • 100% Shut-Off with Continuous Retry



**MODEL PTC**

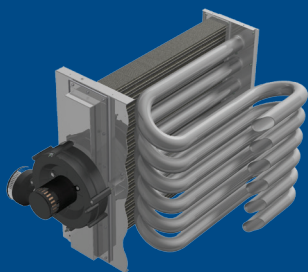

**MODINE CONSERVICORE® HEAT EXCHANGER**

At 93% thermal efficiency for all model sizes, Modine's Effinity<sup>93</sup> condensing unit heater features the highest efficiency available in North America for commercial and industrial, as well as residentially certified (sizes 110 and smaller) gas-fired unit heaters. This industry leading efficiency is a result of the coupling of our Conservicore® secondary heat exchanger technology with our robust tubular primary heat exchanger design. The Conservicore® technology features a secondary recuperative heat exchanger fabricated from AL29-4C® stainless steel. This material is superior to other lower grades of stainless steel and aluminum, resulting in outstanding ability to withstand the corrosive environment of condensing gas fired equipment.

Available in ten model sizes with input ranges from 55,000 to 310,000 Btu/Hr, Modine offers application flexibility unmatched in the industry. The separated combustion units draw combustion air from outside to ensure that the unit will always have plenty of fresh, clean air for combustion while increasing the overall heating efficiency. Venting material to be used is PVC, an extremely cost effective vent system.

- 93% thermal efficiency for fuel savings.
- Conservicore® secondary heat exchanger made of AL29-4C® stainless steel.
- A sealed compartment protects the combination gas valve, ignition control, manifold, and burner from the environment.
- External gas connections.
- Uses natural or propane gas (field convertible from natural to propane gas).
- Certified for residential (55-110MBH), commercial, and industrial use.
- Standard Contractor Convenience Package with diagnostic LEDs, disconnect switch, and condensate pump outlet.
- Standard power exhaust simplifies side-wall or roof venting with small-diameter pipe.
- Horizontal or vertical two-pipe or concentric venting options.
- Permanently lubricated motor for trouble-free dependability.
- Full 10-year warranty on both heat exchangers.

For blower model data, see page 8.

**Table 6.1 - Propeller Unit Heater Model PTC General Performance Data**

	PTC Model Sizes									
	55 ③	65 ③	85 ③	110 ③	135	156	180	215	260	310
<b>Btu/Hr Input ①</b>	55,000	65,000	85,000	110,000	135,000	155,000	180,000	215,000	260,000	310,000
<b>Btu/Hr Output ①</b>	51,150	60,450	79,050	102,300	125,550	144,150	167,400	199,950	241,800	288,300
<b>Condensate Production (Gal/Hr)</b>	0.3	0.4	0.5	0.7	1.0	1.1	1.3	1.6	1.9	2.3
<b>Entering Airflow (CFM) @ 70°F ②</b>	1097	1141	1650	1750	2160	2600	3020	3865	4585	5400
<b>Air Temp Rise (°F)</b>	43	49	44	54	54	51	51	48	49	49
<b>Max. Mounting Height (Ft.) ②</b>	12	12	13	13	14	18	15	17	20	19
<b>Heat Throw (Ft.) @ Max. Mtg. Ht.</b>	43	43	48	46	51	62	53	60	70	67

① Ratings shown are for elevations up to 2,000 Ft. For elevations above 2,000 feet, ratings should be reduced at the rate of 4% for each 1,000 feet above sea level. (In Canada see rating plate.) Reduction of ratings requires use of a high altitude kit.

② Data taken at 65°F ambient and unit fired at full-rated input. Mounting height as measured from bottom of unit, and without deflector hoods.

③ Also certified for residential installations.

④ AL29-4C is a Registered Trademark of Allegheny Ludlum Corporation.

⑤ Effinity<sup>93</sup>, Conservicore®, and any combination of these names either together or with other words is trademarked by Modine Manufacturing Co.

Heaters are designed for use in heating applications with ambient temperatures between 40°F and 80°F. Heaters should not be used in applications where the heated space temperature is below 40°F. The combination of low space and combustion air temperatures may result in condensate freezing in the secondary heat exchanger and/or condensate drain.

**DO NOT LOCATE ANY GAS-FIRED UNIT IN AREAS WITH CHLORINATED, HALOGENATED, OR ACIDIC VAPORS IN ATMOSPHERE.**

Request Catalog 6-170 For Complete Technical Information and Specifications.





**Figure 7.1 - U.S. Average Heat Load Hours Map**

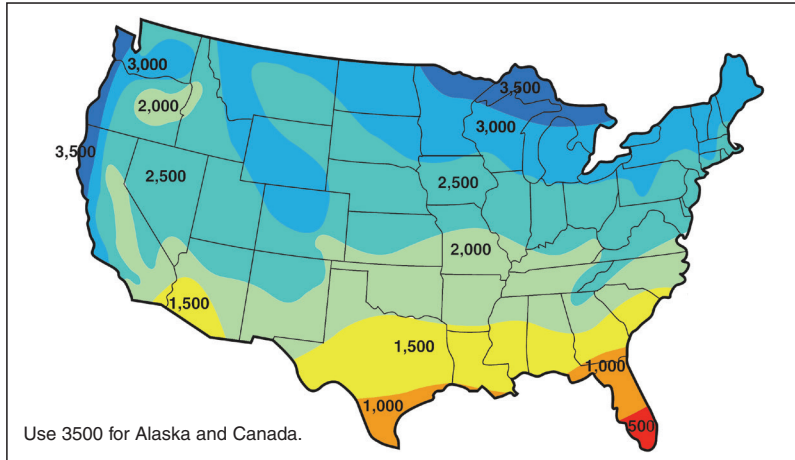

**Table 7.1 - Estimated Annual Fuel Cost Savings Using the Effinity<sup>93</sup> Condensing Unit Heater**

		Estimated Annual Savings Against Other Equipment ① ②			
		Gravity Vented		Power Vented	
Design Heat Load (Btu/Hr):		120,000	280,000	120,000	280,000
Annual Heat Load Hours (refer to Figure 7.1)	500	\$306	\$713	\$136	\$318
	1000	\$611	\$1,427	\$273	\$637
	1500	\$917	\$2,140	\$409	\$955
	2000	\$1,223	\$2,853	\$546	\$1,274
	2500	\$1,529	\$3,567	\$682	\$1,592
	3000	\$1,834	\$4,280	\$819	\$1,911
	3500	\$2,140	\$4,993	\$955	\$2,229

① Based on a natural gas rate of \$1.10/Therm. Actual realized savings can vary significantly based on a number of changing factors including, but not limited to, fuel prices, climate, building use or construction, etc.

② Compares 93% efficient against 65% seasonal efficient gravity vented and 78% seasonal efficient power vented.

**Table 7.2 - Effinity<sup>93</sup> PTC260 (260,000 BTU/hr) vs. Comparable Power-Vented Unit Heater ①**

Uses Less Natural Gas for Fewer CO <sub>2</sub> Emissions			
City	Annual Gas Savings	Equivalent Urban Trees Planted	Pounds of CO <sub>2</sub> Saved
Chicago, IL	\$914	154 trees	13,261
Las Vegas, NV	\$325	58 trees	4,945
Minneapolis, MN	\$903	187 trees	16,099
Nashville, TN	\$555	88 trees	7,350
Oklahoma City, OK	\$656	96 trees	8,278
Philadelphia, PA	\$916	118 trees	10,131
Portland, OR	\$671	109 trees	9,328

① Savings are realized by comparing the Effinity<sup>93</sup> BTU/hr output to a 78% seasonally efficient power-vented heater. Savings were determined by applying appropriate degree days at 65 degrees indoor design temperature under full year, 24/7 operation to each state's 2012 average price/therm of gas.

**DO NOT LOCATE ANY GAS-FIRED UNIT IN AREAS WITH CHLORINATED, HALOGENATED, OR ACIDIC VAPORS IN ATMOSPHERE.**



Request Catalog 6-170 For Complete Technical Information and Specifications.

# GAS-FIRED, BLOWER MODELS



**MODEL HDB**



**MODEL BDP**



**MODEL BTS**



**MODEL BTC**

Blower unit heaters are designed for both heating and ventilating. All Modine gas-fired unit heater types can be equipped with blowers, including our Hot Dawg® low-profile residential garage heaters and the Effinity<sup>93</sup>. In fact, the Effinity<sup>93</sup> is the only high efficiency gas-fired unit heater in North America with this option available.

**These units can be used in a variety of ways:**

- Ducting air in from adjacent spaces for ventilation.
- Protecting units from corrosive spaces by mounting them remotely and ducting in warm air.
- Where quietness is important, blower fans are lower-noise and can be ducted, unlike propeller units.
- Deflector hoods can be used in areas with higher mounting heights.

**Table 8.1 - Power-Exhausted Blower Unit Model HDB and BDP General Performance Data**

	Model HDB Sizes				Model BDP Sizes						
	60	75	100	125	150	175	200	250	300	350	400
Btu/Hr Input ①	60,000	75,000	100,000	125,000	150,000	175,000	200,000	250,000	300,000	350,000	400,000
Btu/Hr Output ①	49,200	61,500	82,000	102,500	123,000	143,500	164,000	205,000	246,000	287,000	328,000
Entering Airflow Range (CFM)	635-1111	794-1389	1140-2116	1235-2058	1587-2778	1852-3241	2116-3704	2646-4630	3175-5556	3704-6481	4233-6584
Outlet Velocity (FPM)	437-726	546-908	443-781	488-773	869	892	773	966	1026	1037	1008
Air Temp. Rise (°F)	40-70	40-70	35-65	45-75	40-70	40-70	40-70	40-70	40-70	40-70	40-70
Max. Mounting Height (Ft.) ②	7-13	7-16	8-19	8-17	14	15	13	16	18	19	19
Heat Throw (Ft.) @ Max Mtg Ht ②	20-45	24-57	27-68	27-59	49	52	47	58	64	67	68

**Table 8.2 - Separated Combustion Blower Unit Model HDC and BTS General Performance Data**

	Model HDC Sizes				Model BTS Sizes						
	60	75	100	125	150	175	200	250	300	350	400
Btu/Hr Input ①	60,000	75,000	100,000	125,000	150,000	175,000	200,000	250,000	300,000	350,000	400,000
Btu/Hr Output ①	49,200	61,500	82,000	102,500	123,000	143,500	164,000	205,000	246,000	287,000	328,000
Entering Airflow Range (CFM)	635-1111	794-1389	1140-2116	1235-2058	1587-2778	1852-3241	2116-3704	2646-4630	3175-5556	3704-6481	4233-7407
Air Temp. Rise (°F)	40-70	40-70	35-65	45-75	40-70	40-70	40-70	40-70	40-70	40-70	40-70
Max. Mounting Height (Ft.) ②	7-13	7-16	8-19	8-17	9-21	8-18	9-21	10-22	11-26	11-26	13-29
Heat Throw (Ft.) @ Max Mtg Ht ②	20-45	24-57	27-68	27-59	33-75	28-65	32-74	34-78	40-94	39-90	44-102

**Table 8.3 - Separated Combustion, High-Efficiency Condensing Blower Unit Heater Model BTC General Performance Data**

	Model BTC Sizes		
	215	260	310
Btu/Hr Input ①	215,000	260,000	310,000
Btu/Hr Output ①	199,950	241,800	288,300
Condensate Production (Gal./Hr.)	1.6	1.9	2.3
Entering Airflow Range (CFM)	2645-4628	3198-5597	3813-6674
Air Temp. Rise (°F)	40-70	40-70	40-70
Max. Mounting Height (Ft.) ③	9-22	11-26	11-26
Heat Throw (Ft.) @ Max. Mtg Ht	33-77	40-94	39-91

① Ratings shown are for elevations up to 2,000 Ft. For elevations above 2,000 feet, ratings should be reduced at the rate of 4% for each 1,000 feet above sea level. (In Canada see rating plate.) Reduction of ratings requires use of a high altitude kit.

② Data taken at 55°F air temperature rise. At 65°F ambient and unit fired at full-rated input. Mounting height as measured from bottom of unit, and without deflector hoods.

③ Data taken at 65°F ambient and unit fired at full-rated input. Mounting height as measured from bottom of unit, and without deflector hoods.

**DO NOT LOCATE ANY GAS-FIRED UNIT IN AREAS WITH CHLORINATED, HALOGENATED, OR ACIDIC VAPORS IN ATMOSPHERE.**

Request Catalog 6-189 (HDB, BDP), 6-175 (BTS) and 6-170 (BTC) For Complete Technical Information and Specifications.





# GAS-FIRED, GRAVITY AND POWER-VENTED DUCT FURNACES

- Low Initial Cost • Applications Cover Heating and/or Make-Up Air • 75,000 to 400,000 Btu/Hr Input Capacity
- 82% Minimum Thermal Efficiency • Low Maintenance • Easy to Service

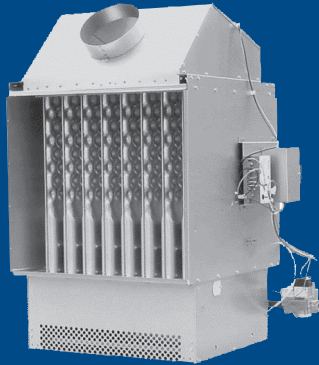

**MODEL DFG  
GRAVITY VENTED**

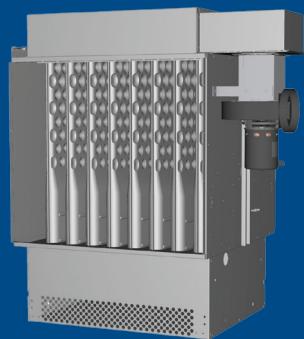

**MODEL DFP  
POWER VENTED**

The Modine indoor duct furnace was designed for use with a building's heating, heating/cooling and make-up air systems. Available in 11 model sizes, in both gravity and power vented configurations, the unit covers a wide variety of applications. They have input ranges from 75,000 to 400,000 Btu/Hr and can operate on either natural or propane gas. The airflow direction can be specified when ordering the unit. The duct furnace is certified for location either upstream or downstream from cooling coils and has a drain pan that allows connection to a condensate drain line.

### Standard features include:

- C.S.A. certification.
- ETL certification.
- All units a minimum of 82% thermally efficient.
- 20 gauge aluminized steel cabinet.
- Certified to 3.0" W.C. external static pressure for high static applications.

### Optional features include:

- 409 stainless steel heat exchanger and burner.
- 409 stainless steel drip pan.
- Two-stage and electronic modulation controls for either natural or propane gas.
- Building management compatible gas controls for modulation control using 0 - 10 Vdc or 4 - 20 mA input.
- High and/or low gas pressure switches.

**Table 9.1 - DFG/DFP Duct Furnace Performance Data** ① ② ③

DFG/DFP Model Size	Btu/Hr		Without Air Baffle		With Air Baffle	
	Input	Output	Temperature Rise Range (°F)	CFM Range	Temperature Rise Range (°F)	CFM Range
75	75,000	61,500	20 - 60	926 - 2,778	20 - 100	556 - 2,778
100	100,000	82,000	20 - 60	1,235 - 3,704	20 - 100	741 - 3,704
125	125,000	102,500	20 - 60	1,543 - 4,630	20 - 100	926 - 4,630
150	150,000	123,000	20 - 60	1,852 - 5,556	20 - 100	1,111 - 5,556
175	175,000	143,500	20 - 60	2,160 - 6,481	20 - 100	1,296 - 6,481
200	200,000	164,000	20 - 60	2,469 - 7,407	20 - 100	1,481 - 7,407
225	225,000	184,500	20 - 60	2,778 - 8,333	20 - 100	1,667 - 8,333
250	250,000	205,000	20 - 60	3,086 - 9,259	20 - 100	1,852 - 9,259
300	300,000	246,000	20 - 60	3,704 - 11,111	20 - 100	2,222 - 11,111
350	350,000	287,000	20 - 60	4,321 - 12,963	23 - 100	2,593 - 11,111
400	400,000	328,000	20 - 60	4,938 - 14,815	27 - 100	2,963 - 11,111

① Ratings are shown for elevations up to 2,000 feet.

② Model DFP units approved for use in California by CEC.

③ When high rates of CFM are used, the air distribution baffle may be removed to reduce the pressure drop through the duct furnace.

DFG is design certified by CSA for the gas heating furnace section, and ETL for the electrical controls.

DFP is design certified by ETL for both the gas heating furnace section and the electrical controls.



**DO NOT LOCATE ANY GAS-FIRED UNIT IN AREAS WITH CHLORINATED, HALOGENATED, OR ACIDIC VAPORS IN ATMOSPHERE.**

Request Catalog 5-174 For Complete Technical Information and Specifications.

# GAS-FIRED, HIGH-INTENSITY INFRARED UNITS

- 30,000 to 200,000 Btu/Hr Input • Simple Chain Mounting • High Heat Transfer Ceramic Tiles • Unvented Operation • Low Installation Cost • Ideal for Spot Heating • Available in Natural or Propane Gas

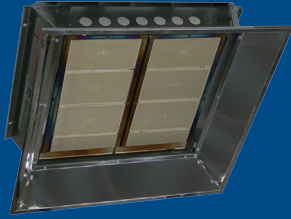

**MODEL IHR**

Modine's high-intensity ceramic infrared heater is approved for indoor unvented installation. It does not utilize a fan, thus eliminating noise and draft distractions. Gas and power connections are simple and maintenance is inexpensive, since there are no moving parts to maintain. Available controls include Direct Spark Ignition, Self-Generating Millivolt, and Intermittent Pilot (non-100% shut-off).

**Modine's IHR series heaters include the following features:**

- Rugged aluminized steel frame.
- Exclusive ceramic burner provides maximum infrared radiation.
- Stainless steel rods increase heat temperature and efficiency.
- Highly polished aluminum reflector design.
- Direct spark or pilot ignition.
- Potted circuitry for protection in high moisture environments (DSI only).
- 5-year limited ceramic burner warranty.
- CSA Design Certified, UL-Listed, CE Certified.

**Table 10.1 - IHR High-Intensity Infrared Heater Performance Data**

Model Size	Gas Controls ③④	Input Rating (Btu/hr)	Recommended Mounting Height (Ft.)		Radiating Surface (sq. in.)
			Standard Reflector	Parabolic Reflector	
			30°	30°	
<b>IRH 30</b>	Single Stage or Millivolt	30,000	12 - 14	12 - 15	85
<b>IRH 60</b>	Single Stage or Millivolt	60,000	14 - 16	18 - 21	170
<b>IHR 90</b>	Single Stage or Millivolt	90,000	16 - 18	21 - 25	255
<b>IHR 130</b>	Single Stage or Millivolt	130,000	21 - 24	26 - 32	340
<b>IHR 160</b>	Single Stage or Millivolt	160,000	24 - 28	29 - 35	425

**DO NOT LOCATE ANY GAS-FIRED UNIT IN AREAS WITH CHLORINATED, HALOGENATED, OR ACIDIC VAPORS IN ATMOSPHERE.**

Request Catalog 9-122 For Complete Technical Information and Specifications.

## GAS-FIRED, HIGH-INTENSITY INFRARED UNITS

- 31,000 to 34,000 Btu/Hr Input • Simple Bracket Mounting • High Heat Transfer Ceramic Tiles • Unvented Operation • Low Installation Cost • Available in Natural or Propane Gas



**MODEL OHP**

Modine's high-intensity ceramic Patio infrared heater is approved for indoor and outdoor residential or commercial applications. It does not utilize a fan, thus eliminating noise and draft distractions. Gas and power connections are simple and maintenance is inexpensive, since there are no moving parts to maintain. Potted (Water Resistant) 24 V circuitry.

**Modine's OHP series heaters include the following features:**

- Rugged aluminized steel frame.
- ETL Design Certified to the latest edition of the ANSI Z83.26 Standard.
- Decorative stainless steel windscreen eggcrate grille.
- Wind and rain protected design.
- Reliable direct spark ignition.
- Potted (water resistant) 24V circuitry.
- Black coated aluminized steel or brushed stainless steel housing.

**Table 11.1 - OHP High-Intensity Infrared Heater Performance Data**

Model Size	Housing	BTU/Hr Input	Ship Weight	Recommended Mounting Heights ①	Approx. Area	Control Voltage
OHP 31	430 SS	31,000	59 lbs	8.0' to 12.0'	8' x 8'	24 vac
OHP 34	430 SS	34,000	59 lbs	8.5' to 13.0'	9' x 9'	24 vac

Request Catalog 5-157 For Complete Technical Information and Specifications.

# GAS-FIRED, LOW-INTENSITY INFRARED UNITS

- Pressurized Type, Low-Intensity Heater • 50,000 to 200,000 Btu/Hr Input • 20 to 70 Foot System Lengths
- Straight and U-Shaped Configurations • Simple Chain Mounting • Designed for Indoor or Outdoor, Vented or Unvented, Commercial and Industrial Installation • Available in Natural or Propane Gas



**MODEL IPT**

Modine's single-burner positive pressure infrared heater is approved for vented or unvented commercial and industrial applications. A water-resistant control compartment provides weatherproof protection and allows either indoor or outdoor installation.

**Modine's low-intensity IPT series heaters include the following features:**

- Heat-treated 16 gauge aluminized steel heat exchanger provides enhanced corrosion resistance and radiant heat transfer.
- Durable 16 gauge aluminized steel combustion chamber.
- Blocked intake/exhaust shut-off switch.
- Controls located in enclosed, water-resistant compartment for indoor or outdoor installation.
- 180° rotatable gas valve, accessible from either side of burner box.
- Durable polyester powder paint maintains life-long appearance.
- Side access panels for servicing either side of the burner box.
- Improved serviceability with sight window for flame viewing, indicator lights for combustion blower operation and a removable cover.
- Thermal efficiencies of up to 80% maximize fuel savings

**Table 12.1 - IPT Low-Intensity Infrared Heater Performance Data**

Model Size	Btu/Hr Input	System Lengths (Ft.)	Recommended Mounting Height (Ft.)
<b>IPT 50</b>	50,000	20, 30	10 - 12
<b>IPT 60</b>	60,000	20, 30, 40	10 - 12
<b>IPT 75</b>	75,000	20, 30, 40	12 - 14
<b>IPT 100</b>	100,000	30, 40, 50 ①	12 - 14
<b>IPT 125</b>	125,000	40, 50, 60	15 - 22
<b>IPT 150</b>	150,000	50, 60	15 - 25
<b>IPT 175</b>	175,000	50, 60, 70	18 - 28
<b>IPT 200</b>	200,000	50, 60, 70	20 - 30

① Consult factory for propane operation at 50 Ft. system length.



**DO NOT LOCATE ANY GAS-FIRED UNIT IN AREAS WITH CHLORINATED, HALOGENATED, OR ACIDIC VAPORS IN ATMOSPHERE.**

Request Catalog 9-117 For Complete Technical Information and Specifications.



# HOT DAWG H<sub>2</sub>O® - LOW PROFILE HOT WATER UNIT HEATER

- Low Profile Design • Available in Two Model Sizes • Side Access Piping and Electrical Connections • Flexible Mounting Orientations • Attractive Hammertone Beige Powdercoat Paint Finish • High Capacity Two-Row Hot Water Coil • Twin Blower Wheels

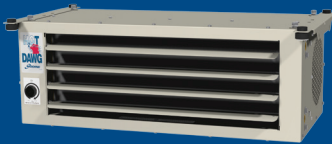

**MODEL HHD**



For applications requiring a low profile unit, Modine offers the Hot Dawg H<sub>2</sub>O® hot water unit heater. The Hot Dawg H<sub>2</sub>O® may be installed in residential or commercial applications just one inch below the ceiling. The superior quality matched with the following features makes the Hot Dawg H<sub>2</sub>O® unit heater an easy choice for a variety of applications:

- Low profile design is ideally suited for residential garages, basements, vestibules, commercial, industrial, institutional installations. Non-potable water applications only.
- Low profile, 18 gauge steel cabinet results in a clean appearance that maximizes head room.
- Cabinet pre-treated for prevention of rust and corrosion and finished with a durable electrostatically applied baked-on polyester powdercoat paint. Attractive Hammertone Beige paint color.
- Horizontal adjustable air-deflector blades.
- Fingerproof inlet air openings.
- Side access piping and electrical.
- Electrical connections are standard on the left with piping on the right. Access sides can be easily reversed in the field by simply flipping the unit over.
- Two L-shaped mounting brackets.
- Brackets designed to match up to standard 16" on-center joist spacing.
- Mounting orientation flexibility includes:
  - Horizontal air delivery, mounted parallel to joists.
  - Horizontal air delivery, mounted perpendicular to joists.
  - Vertical air delivery, mounted between joists.
- High capacity, 2-row hot water coil.
- Copper tubes mechanically expanded into aluminum fins for maximum heat transfer.
- 1/2" NPT piping connections.
- Coils suitable for water pressures up to 150PSI and temperatures up to 200°F.
- Twin centrifugal blower wheels for quieter operation.
- Dual shaft blower motor (115V/60Hz/1ph).
- Solid state speed controller standard on Model size HHD 45.
- Factory supplied neoprene vibration isolators.

**Table 13.1 - Performance Data** ① ②

Model Size	Airflow (CFM)	GPM	WPD (Ft. Water)	Entering Water Temperature (60°F Entering Air Temperature)									
				120°F		140°F		160°F		180°F		200°F	
				Btu/Hr	WTD	Btu/Hr	WTD	Btu/Hr	WTD	Btu/Hr	WTD	Btu/Hr	WTD
30	405	1	0.6	11,900	25	15,800	33	19,800	41	23,700	49	27,700	58
		2	2.2	15,500	16	20,600	22	25,800	27	30,900	32	36,100	38
		3	4.7	17,200	12	22,900	16	28,600	20	34,400	24	40,100	28
		4	7.9	18,200	10	24,200	13	30,300	16	36,300	19	42,400	22
		5	12	19,600	8	26,100	11	32,600	14	39,200	16	45,700	19
45	710 (High Speed)	1	0.6	17,200	36	22,900	48	28,600	60	34,400	72	40,100	84
		2	2.2	22,400	23	29,900	31	37,300	39	44,800	47	52,300	55
		3	4.7	24,900	17	33,200	23	41,500	29	49,800	35	58,100	40
		4	7.9	26,400	14	35,100	18	43,900	23	52,700	27	61,500	32
		5	12	28,400	12	37,800	16	47,300	20	56,800	24	66,300	28
	425 (Low Speed)	1	0.6	11,900	25	15,900	33	19,900	41	23,900	50	27,900	58
		2	2.2	15,600	16	20,700	22	25,900	27	31,100	33	36,300	38
		3	4.7	17,300	12	23,000	16	28,800	20	34,600	24	40,300	28
		4	7.9	18,300	10	24,400	13	30,500	16	36,600	19	42,700	22
		5	12	19,700	8	26,300	11	32,800	14	39,400	16	46,000	19

① For conditions other than shown above, please refer to the Modine Breeze® AccuSpec program for detailed performance data.

② Allowable water temperature range is 100°F to 200°F. Allowable indoor air temperature range is 40°F to 100°F. If temperatures below freezing are expected, provisions should be made to either drain the unit heater coil or utilize a continually circulating glycol solution.



Request Catalog 1-115 For Complete Technical Information and Specifications.

# STEAM/HOT WATER, HORIZONTAL DELIVERY UNIT HEATERS

- Totally-Enclosed Motor • Thermal Overload Protection • Adjustable Horizontal Blades • Top/Bottom (Model HSB) or Side (Model HC) Inlet/Outlet Piping • Fan Safety Guard • High Air Velocity Models PT/PTN



**MODEL HSB**



**MODEL HC**



**MODEL PT/PTN**



An industry leader since Arthur B. Modine invented and patented the first lightweight, suspended hydronic unit heater in 1923, the Modine hydronic unit heater has proven one of the most popular of all unit-heater types in commercial and industrial applications. Designed for long heat-throw and uniform heat delivery, two types are offered:

- **Horizontal Delivery Units (Model HSB/HC)** – Recommended for use in buildings where ceilings are low and with few obstructions. Units are normally placed around the perimeter of the building so that the air stream from each heater “wipes” the wall to produce a blanket of warm air along walls where heat loss is greatest.
- **Power-Throw™ High Velocity Horizontal Delivery Units (Model PT/PTN)** – Recommended where there is a requirement for heat throw greater than can be provided by standard horizontal delivery models. For hard-to-heat areas, such as frequently opened loading dock doors or large warehouses, Power-Throw™ units are an ideal choice. A single Power-Throw™ unit can often replace as many as three smaller horizontal delivery units, reducing equipment, installation, and maintenance costs.

**Standard features include:**

- Top/bottom (Model HSB) or side (Model HC) inlet/outlet piping.
- Units install quickly, easily, and at low cost because they are lightweight, yet are ruggedly constructed to resist rigorous handling and on-the-job abuse.
- Carefully-selected motors and fans with a scientifically designed venturi fan-shroud reduce noise levels to a satisfactory minimum.
- Totally enclosed motor with thermal-overload protection.
- Fans are statically and dynamically balanced.
- Fan and motor assemblies are exposed and can be removed without lowering the unit heater.
- The unit casing is treated for protection against corrosion prior to the application of the attractive gray-green, baked-on polyester powder coat paint finish.
- Horizontal air deflector blades are standard (vertical deflector blades available).
- Low outlet temperature models are recommended for steam pressure above 30 PSI, but can also be used in dirty environments to minimize buildup of air contaminants on the coil.
- Modine PTN models feature coils made from cupro-nickel tubes that have the extra strength to withstand higher steam pressures (250 PSI) or water temperatures (400°F).

**Table 13.1 - Horizontal Steam/Hot Water Unit Heater Performance Data**

Model No.	Motor Data ①		Standard Models									
			Steam (2# Steam, 60°F Ent. Air)			Hot Water (200°F in 180°F out, 60°F Ent. Air)			CFM	Max. Mounting Height (Ft.)	Throw @ Max. Mounting Height (Ft.)	
	HP	Approx RPM	Btu/Hr	Condensate (Lbs/Hr)	Final Air Temp. (°F)	Btu/Hr	Water Flow (GPM)	Final Air Temp. (°F)				Press. Drop (Ft of Water)
HSB/HC 18	1/60	1550	18,000	18	107	12,600	1.3	94	0.5	340	8	17
HSB/HC 24	1/25	1550	24,000	25	119	16,300	1.7	100	0.8	370	9	18
HSB/HC 33	1/25	1550	33,000	35	108	21,700	2.3	91	0.2	630	10	21
HSB/HC 47	1/12	1550	47,000	49	119	30,900	3.2	98	0.4	730	12	28
HSB/HC 63	1/12	1550	63,000	66	111	45,600	4.7	97	0.6	1120	14	29
HSB/HC 86	1/8	1625	86,000	89	118	60,200	6.3	101	1.0	1340	15	31
HSB/HC 108	1/8	1625	108,000	111	109	83,700	8.7	98	2.8	2010	17	31
HSB/HC 121	1/5	1075	121,000	126	122	93,000	9.7	108	3.3	1775	16	25
HSB/HC 165	1/3	1075	165,000	170	106	130,900	13.6	97	8.6	3240	19	40
HSB/HC 193	1/3	1075	193,000	200	121	143,000	14.9	105	1.4	2900	18	38
HSB/HC 258	1/2	1075	258,000	267	111	202,000	21.0	100	5.7	4560	19	44
HSB/HC 290	1/2	1075	290,000	300	117	228,600	23.8	105	7.1	4590	20	46
HSB/HC 340	1/2	1075	340,000	352	120	271,100	28.2	108	11.3	5130	20	46
PT/PTN 279	1/2	1075	279,000	288	111	192,400	20.0	94	0.2	5460	16	100
PT/PTN 333	3/4	1140	333,000	345	116	238,500	24.8	99	0.4	5980	17	110
PT/PTN 385	1	1140	385,000	398	110	276,100	28.8	95	0.6	7680	17	115
PT/PTN 500	1-1/2	1140	500,000	518	108	358,000	37.3	93	0.5	10,390	18	130
PT/PTN 610	1-1/2	1140	610,000	631	112	450,400	46.9	97	1.0	11,750	20	140
PT 952	2	1140	952,000	986	139	721,600	75.2	120	1.1	12,170	21	145

① Applies to most popular motor.

Request Catalog 1-150 For Complete Technical Information and Specifications.

# STEAM/HOT WATER, VERTICAL DELIVERY UNIT HEATERS

- 15 Standard Models • Lightweight, Easy to Install • Totally-Enclosed Motors • 33,000 to 952,000 Btu/Hr Input
- Built-In Fan Safety Guard



**MODEL V/VN**

Modine model V/VN vertical steam/hot water unit heaters are designed for long heat-throw, uniform comfort heat delivery, and reduced maintenance. The units are recommended for areas where ceilings are high or where obstructions do not permit good horizontal movement of air.

**Standard features include:**

- Units install quickly, easily, and at low cost because they are lightweight, yet are ruggedly constructed to resist rigorous handling and on-the-job abuse.
- Carefully-selected motors and fans with a scientifically designed venturi fan-shroud reduce noise levels to a satisfactory minimum.
- Totally enclosed motor with thermal-overload protection.
- A motor heat shield protects the motor from heated air passing through the heater.
- Fans are statically and dynamically balanced.
- Fan and motor assemblies are exposed and can be removed without lowering the unit heater.
- The unit casing is treated for protection against corrosion prior to the application of the attractive gray-green, baked-on polyester powder coat paint finish.
- A variety of deflector-blade options provides an increased degree of control over air-discharge direction.
- Low outlet temperature models are recommended for steam pressure above 30 PSI, but can also be used in dirty environments to minimize buildup of air contaminants on the coil.
- Modine VN models feature coils made from cupro-nickel tubes that have the extra strength to withstand higher steam pressures (250 PSI) or water temperatures (400°F).

**Table 14.1 - Vertical Steam/Hot Water Unit Heater Performance Data**

Model Size	Motor Data ①		Standard Models									
			Steam (2# Steam, 60°F Ent. Air)			Hot Water (200°F in 180°F out, 60°F Ent. Air)				CFM	Max. Mounting Height (Ft.)	Heat Spread (Ft.) <sup>②</sup>
	HP	Approx RPM	Btu/Hr	Condensate (Lbs/Hr)	Final Air Temp. (°F)	Btu/Hr	Water Flow (GPM)	Final Air Temp. (°F)	Press. Drop (Ft of Water)			
V/VN 42	1/30	1050	42,000	43	103	30,100	3.1	90	0.6	950	15	11
V/VN 59	1/30	1050	59,000	61	111	42,600	4.4	96	0.5	1155	19	14
V/VN 78	1/15	1050	78,000	81	109	57,000	5.9	95	0.5	1590	20	15
V/VN 95	1/15	1050	95,000	99	118	69,300	7.2	101	0.5	1665	20	15
V/VN 139	1/5	1075	139,000	144	112	106,600	11.1	99	2.6	2660	24	18
V/VN 161	1/3	1075	161,000	167	115	123,200	12.8	101	2.2	2940	27	20
V/VN 193	1/3	1075	193,000	200	116	147,200	15.3	101	2.2	3500	30	22
V/VN 212	1/3	1075	212,000	219	120	161,700	16.8	104	1.5	3610	30	22
V/VN 247	1/2	1075	247,000	256	111	188,700	19.7	98	2.1	4820	34	26
V/VN 279	1/2	1075	279,000	288	111	212,700	22.2	98	2.1	5460	37	30
V/VN 333	3/4	1140	333,000	345	116	260,100	27.1	103	3.8	5980	37	30
V/VN 385	1	1140	385,000	398	110	302,100	31.5	98	5.0	7680	36	30
V/VN 500	1-1/2	1140	500,000	518	108	391,700	40.8	97	4.8	10,390	44	37
V/VN 610	1-1/2	1140	610,000	631	112	450,400	46.9	97	1.0	11,750	43	36
V 952	2	1140	952,000	986	139	721,600	75.2	120	1.1	12,170	45	56

① For most popular motor used on each model.

② At 2 psi steam, 60°F entering air – unit heaters equipped with cone-jet deflectors.



Request Catalog 1-150 For Complete Technical Information and Specifications.

# OIL-FIRED, HORIZONTAL DELIVERY UNIT HEATERS

- Three Sizes • Pressure-Atomizing, Gun-Type Oil Burner • Cad-Cell Safety Shut-Off • Electric-Spark Ignition
- Fan and Limit Control



**MODEL POR**

Modine model POR oil-fired unit heaters are built with time-tested and field-proven components to provide optimum comfort and heating efficiency as high as 84%.

**Standard features include:**

- A long-life heat exchanger is made of corrosion-resistant, aluminized steel and roll-formed to eliminate thermal stress. It contains a preformed, ceramic fiber fire-pot that is lightweight, resilient, and resists both mechanical and thermal shocks.
- For ease of service, the heat exchanger is equipped with an inspection port, two clean-out ports, and an amply-sized service door for removing fire pot when replacement becomes necessary.
- A reliable, pressure-atomizing gun-type burner equipped with a stainless steel, die-stamped flame-retention head that can increase combustion efficiency by as much as 20 to 30 percent over non-flame retention-type burners.
- Beckett microprocessor-based ignition controller providing superior combustion and safety monitoring.
- Onboard diagnostics with LED output for simplifying the lives of service personnel.
- Interrupted-duty ignition that disables the spark once ignition is proven. Older technology uses a continuous spark that is noisy, prone to shorter lifespan, and not energy efficient.
- Electronic oil igniter module with superior spark voltage (20kV) replaces traditional bulky ignition transformers.
- Beckett CleanCut burner pump that uses a solenoid valve to instantly cut oil flow on shutdown, eliminating soot formation from coasting stops.
- Two stage pump with PSC motor provides maximum fuel pressure delivery, even in high lift applications.
- Finger-proof fan guard.
- The unit casing is treated for protection against corrosion prior to the application of the attractive gray-green, baked-on polyester powder coat paint finish.
- Accessory Outside Combustion Air Kit converts the burner to accept outside combustion air piping for tight building applications.

**Table 15.1 - Oil Fired Unit Heater Performance Data**

Model Size	Input Btu/Hr	Input GPH	Output Btu/Hr	CFM @ 70°F	Delivery FPM	Temp. Rise (°F)	Max Height ①	Heat Throw
POR100	119,000	0.85	100,000	1890	460	49	12'	39'
POR145	175,000	1.25	145,000	2400	580	56	13.5'	50'
POR185	231,000	1.65	185,000	3200	740	54	12'	51'

① Deflector blades pitched 45° toward the floor. Mounting height is measured from floor to bottom of unit.



Request Catalog 4-112 For Complete Technical Information and Specifications.



# ELECTRIC, HORIZONTAL VERTICAL DELIVERY UNIT HEATERS

- Low Installation Cost and Maintenance • Model VE Available in 21 Models, 9 Sizes from 5k W through 50 kW
- Model HER Available in 8 Sizes from kW through 25kW • High-Capacity Unit with Horizontal Air Delivery • Model PTE Available in 3 Sizes from 15kW through 50 kW • Model PTE and VE Offered in Single and Two-Stage Controls



**MODEL HER**

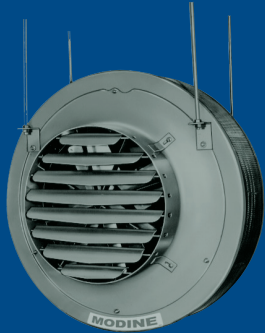

**MODEL PTE**



**MODEL VE**



Modine electric unit heaters provide a wide variety of options in solving comfort-heating problems. Each is designed for long heat-throw, uniform heat-delivery, and reduced maintenance. The types offered are:

- **Horizontal Delivery Units (Model HER)** – Recommended for use in buildings where ceilings are low and with few obstructions. Units are normally placed around the perimeter of the building so that the air stream from each heater “wipes” the wall to produce a blanket of warm air along walls where heat loss is greatest.
- **Power-Throw™ High Velocity Horizontal Delivery Units (Model PTE)** – Recommended where there is a requirement for heat throw greater than can be provided by standard horizontal delivery models. For hard-to-heat areas, such as frequently opened loading dock doors or large warehouses, Power-Throw™ units are an ideal choice. A single Power-Throw™ unit can often replace as many as three smaller horizontal delivery units, reducing equipment, installation, and maintenance costs.
- **Vertical Delivery Units (Model VE)** – Recommended for areas where ceilings are high or where obstructions do not permit good horizontal movement of air.

**Standard features include:**

- Completely factory assembled and wired for specific power supply ordered.
- Finned-tube sheathed nichrome wire heating elements.
- Totally enclosed motor with thermal-overload protection.
- Fans are statically and dynamically balanced.
- A motor heat shield protects the motor from heated air passing through the heater (VE models).
- Fan and motor assemblies are exposed and can be removed without lowering the unit heater.
- The unit casing is treated for protection against corrosion prior to the application of the attractive gray-green, baked-on polyester powder coat paint finish.
- A variety of deflector-blade options provides an increased degree of control over air-discharge direction (VE models).
- Horizontal air deflector blades are standard (vertical deflector blades available) (HER and PTE models).
- Terminal and junction boxes provide easy access to heating-element terminals, an overheat control switch, and the power supply and control connections.
- An automatic reset overheat control.

**Table 16.1 - Electric Unit Heater Performance Data**

Model Size	Heating Capacity		Air Delivery Data					Electrical Rating (Volts/ Hz/Ph)
	kW	Btu/Hr	CFM	Outlet Velocity (FPM)	Temp. Rise (°F) ①	Max. Mounting Height (Ft.) ②	Heat Throw (Ft.) ②	
HER30	3.0	10,200	380	433	25	8	12	208/60/1 240/60/1 208/60/3 240/60/3 480/60/3
HER50	5.0	17,100	380	447	42	8	12	
HER75	7.5	25,600	530	472	45	8	14	
HER100	10.0	34,100	830	730	38	9	20	208/60/3 240/60/3 480/60/3
HER125	12.5	42,700	830	743	38	10	20	
HER150	15.0	51,200	830	754	57	10	20	
HER200	20.0	68,300	1300	825	49	11	25	
HER250	25.0	85,400	1300	842	61	11	25	480/60/3
PTE300	30.0	102,000	2575	1240	40	17	75	
PTE400	40.0	137,000	2575	1240	54	15	60	
PTE500	50.0	171,000	2575	1240	70	14	45	240/60/1 208/60/3 240/60/3 480/60/3
VE50	5.0	17,100	800	700	21	13	20	
VE75	7.5	25,600	800	700	31	11	17	
VE100	10.0	34,100	940	820	36	12	18	③
VE150	15.0	51,200	1340	1170	38	17	26	
VE200	19.0	64,900	1600	1400	41	20	30	
VE250	25.0	85,400	1600	1400	55	17	26	④ 480/60/3
VE300	30.0	102,000	2575	1240	40	20	31	
VE400	40.0	137,000	2575	1240	54	18	27	

① With 70°F ambient air.  
 ② With air deflector blades pitched 45° toward the floor on horizontal models HER and PTE, otherwise no deflector on model VE. Mounting height is measured from floor to bottom of unit.  
 ③ VE150 available in 208V/60Hz/3Ph, 240V/60Hz/3Ph and 480V/60Hz/3Ph  
 ④ VE200 available in 240V/60Hz/3Ph and 480V/60Hz/3Ph

Request Catalog 2-116 For Complete Technical Information and Specifications.

# ELECTRIC, HAZARDOUS LOCATIONS UNIT HEATERS

- Rated for 100,000 Cycles of Service • UL Listed • Sealed Heat-Exchanger Core • Ethylene Glycol for Heat Transfer Fluid • Protected, Explosion-Proof Electric Motor • Two-Piece Fan-Guard



**MODEL HEX**

Modine's HEX electric unit heaters are designed for hazardous industrial locations where potential for explosion exists due to the presence of flammable gases, vapors, powdered-metals or dusts. HEX electric unit heaters are UL-listed for Class I, Divisions 1 & 2, Groups C & D; Class II, Division 1, Groups E, F and G and Class II, Division 2, Groups F and G. UL temperature code shall be T3B 329°F (165°C) for Class I and II, indicating maximum operating-surface temperatures.

**Standard features include:**

- Liquid to air, finned tube heat exchanger core.
- Ethylene glycol water mixture used as heat-transfer fluid in the heater core, providing -49°F (-45°C) freeze damage protection.
- Thermally protected, automatic reset, explosion-proof, motor driven fan moves air across finned tubes for even heat distribution.
- Automatically reset, bimetal high-limit provides over temperature protection and is rated for 100,000 cycles of service.
- Pressure relief valve provides over-pressure protection.
- Epoxy coated, 14 gauge steel cabinet contains heater core, motor, and fan assembly.
- Narrow-gap, two-piece fan-guard shields all moving parts.
- Adjustable extruded aluminum louvers allow directional control of air.
- Copper conductor wires enclosed in steel conduits carry all electrical power.

**Table 17.1 - Explosion Proof Electric Unit Heater Performance Data**

kW	Model Size	Supply Voltage	Heater Amps	Btu/hr	Air Temp Rise (°F)	Max. Mounting Height (Ft.)	Heat Throw (Ft.)
3	HEX5-208160-030	208/60/1	14.4	10,250	11.2	10	30
	HEX5-208360-030	208/60/3	8.3				
	HEX5-240160-030	240/60/1	12.5				
	HEX5-240360-030	240/60/3	7.2				
	HEX5-480360-030	480/60/3	3.6				
5	HEX5-208160-050	208/60/1	24	17,050	18.6	10	30
	HEX5-208360-050	208/60/3	13.9				
	HEX5-240160-050	240/60/1	20.8				
	HEX5-240360-050	240/60/3	12				
	HEX5-480360-050	480/60/3	6				
7.5	HEX5-208160-075	208/60/1	36.1	25,600	27.9	10	30
	HEX5-208360-075	208/60/3	20.8				
	HEX5-240160-075	240/60/1	31.3				
	HEX5-240360-075	240/60/3	18				
	HEX5-480360-075	480/60/3	9				
10	HEX5-208360-100	208/60/3	27.8	34,100	37.2	10	30
	HEX5-240160-100	240/60/1	41.7				
	HEX5-240360-100	240/60/3	24.1				
	HEX5-480360-100	480/60/3	12				
15	HEX5-240360-150	240/60/3	36.1	51,200	27.1	10	40
	HEX5-480360-150	480/60/3	18				
20	HEX5-480360-200	480/60/3	24.1	68,250	36.1	10	40
25	HEX5-480360-250	480/60/3	30.1	85,300	45.2	20	70
30	HEX5-480360-300	480/60/3	36.1	102,350	26.4	20	70
35	HEX5-480360-350	480/60/3	42.1	119,450	30.7	20	70



Request Catalog 2-116 For Complete Technical Information and Specifications.

# MODINE BREEZE® ACCUSPEC SIZING AND SELECTION PROGRAM

• With the Modine AccuSpec Program, Equipment Selection is a Breeze®



The Modine Breeze® AccuSpec is the fastest way to generate performance data based on actual job conditions. The Breeze AccuSpec program is a Web-based sizing and selection program. The program provides a series on step-by-step questions that allow for the easy configuration of Modine products. After a model has been configured, the program can generate Submittal Schedules, Performance Data, Dimensional Drawings, and Specifications.

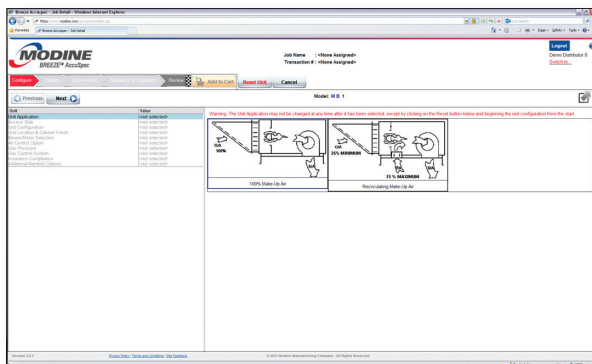

Calculates Equipment Capacities and Capabilities

Pictures for Easy Visual Selection of Equipment

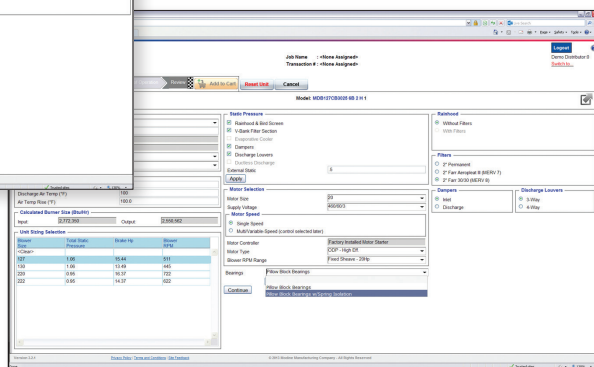

Submittal Schedules

Dimensional Drawings

Specifications

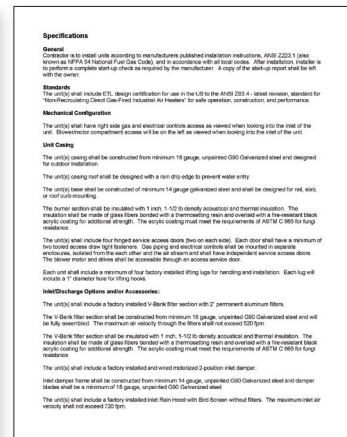
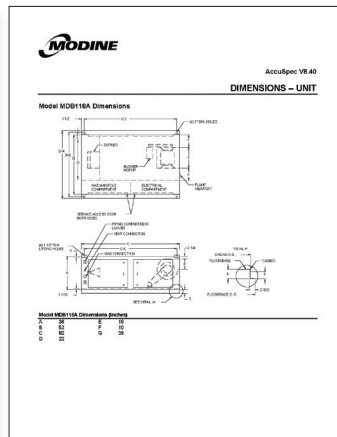
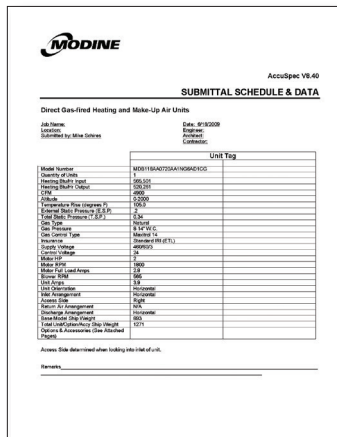

Request Catalog 5-157 For Complete Technical Information and Specifications.



## HISTORY

A.B. Modine founded Modine Manufacturing Company in 1916 as a one-room office adjacent to a small workshop in Racine, WI. Today, Modine is an integral part of the world marketplace with sales approaching \$1.5 billion. It specializes in products used in industrial heating, ventilation and air conditioning equipment, light, medium and heavy-duty vehicles, off-highway and industrial equipment and refrigeration systems.

From the beginning, Modine has applied innovative thermal technology to meet its customers' needs, with breakthroughs yielding state-of-the-art customized heating and cooling solutions.

### 1916 - 1929

Modine is founded by A.B. Modine in 1916



A.B. Modine invents the unit heater by combining an automotive radiator, a fan and steam pipes



The Spirex radiator is patented and Modine's influence in the transportation industry grows

Ford makes the Turbotube radiator standard on all Model Ts. Modine becomes a publicly held company

### 1930 - 1949

Modine moves to current site in Racine, WI

Vehicular wind tunnel built in 1941



Modine begins manufacturing aftercoolers for the P-51 Mustang fighter plane



### 1950 - 1969

Company introduces "Airditioner" a/c unit for residential and non-residential applications

Began producing all-aluminum, brazed a/c coils for cars and trucks

Heating division introduces a line of electric unit heaters

Modine begins manufacturing rooftop a/c and unit ventilators

Buena Vista, VA, home of the Atherion, manufacturing plant opens



### 1970 - 1989

Weatherproof duct furnaces are introduced

Modine introduces the PF™ (parallel flow) condenser



West Kingston, RI, plant acquired and production begins on unitary products



### 1990 - present

Modine acquires Langerer & Reich and forms Modine Europe

New multi-million dollar Tech Center opens in Racine, WI

Modine acquires Airedale, an international leader in a/c products



The Effinity<sup>30™</sup> launches, the most efficient gas-fired unit heater in North America



Modine introduces the Atherion® and Geofinity





---



**THIS PAGE INTENTIONALLY LEFT BLANK**

Request Catalog 5-157 For Complete Technical Information and Specifications.

---



**THIS PAGE INTENTIONALLY LEFT BLANK**

Request Catalog 5-157 For Complete Technical Information and Specifications.

---



**THIS PAGE INTENTIONALLY LEFT BLANK**

Products from Modine are designed to provide indoor air-comfort and ventilation solutions for residential, commercial, institutional and industrial applications. Whatever your heating, ventilating and air conditioning requirements, Modine has the product to satisfy your needs, including:

#### **HVAC**

- Unit Heaters:
  - Gas
  - Hydronic
  - Electric
  - Oil
- Ceiling Cassettes
- Duct Furnaces
- Hydronic Cabinet Unit Heaters, Fin Tube, Convectors
- Infrared Heaters
- Make-up Air Systems
- Unit Ventilators

#### **Ventilation**

- Packaged Rooftop Ventilation

#### **School Products**

- Vertical Packaged Classroom HVAC:
  - DX Cooling/Heat Pump
  - Water/Ground Source Heat Pump
  - Horizontal/Vertical Unit Ventilators

#### **Geothermal**

- Water-to-Water
- Water-to-Air
- Combination

Specific catalogs are available for each product. Catalogs 75-136 and 75-137 provide details on all Modine HVAC equipment.



**Modine Manufacturing Company**

1500 DeKoven Avenue  
Racine, Wisconsin 53403-2552  
Phone: 1.800.828.4328 (HEAT)  
[www.modinehvac.com](http://www.modinehvac.com)

© Modine Manufacturing Company 2017