



# Velo DC



Velo DC > Configure item number from attributes below.

#VEL	Finish	Blade Span	Blade Color	Light Option	Control Option
-	-	-	-	-	-
▲	<b>GW</b> Gloss White	▲	<b>WH</b> White	▲	<b>WC</b> Wall Control
	<b>BN</b> Bright Nickel	<b>48</b> 48" Span	<b>NK</b> Nickel	<b>NL</b> No Light	<b>RC</b> Remote Control
	<b>DB</b> Dark Bronze		<b>DK</b> Dark	<b>853</b> 17W LED	<b>CC</b> Wall/Remote Combo
			<b>EB</b> Ebony		
			<b>GY</b> Graywash		
			<b>MP</b> Maple		
			<b>MG</b> Mahogany		
			<b>WW</b> Whitewash		

## Dimensions

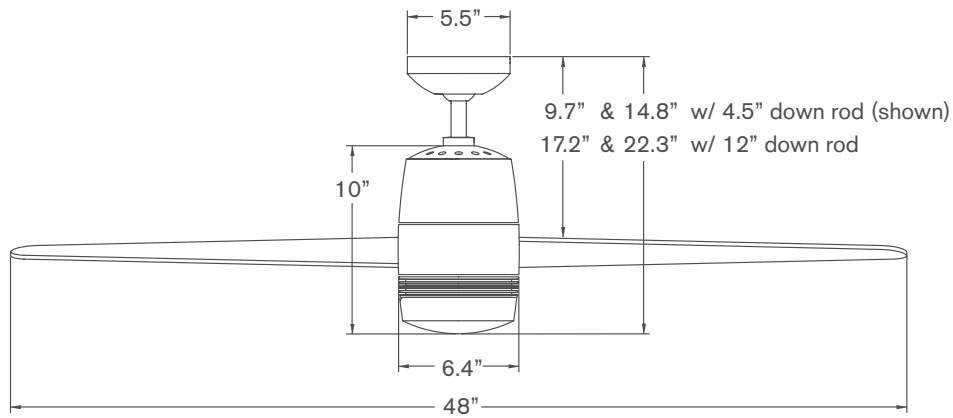

## Specifications

- 6-speed, reversible DC motor
- Die cast aluminum construction
- 48" span, injection-molded ABS blades (solid color or surface-printed woodgrain)
- Includes 4.5" and 12" down rods (longer options also available)
- Optional LED light: 17W, 90 CRI, 3000K, 1530 lumens (dimmable) behind an opal glass diffuser; CA Title 24, JAB-2019 compliant
- Slope compatible up to 33°; adapter available for slopes up to 45°
- Designed by Ron Rezek
- ETL listed for dry and damp locations
- Weight: 14.0 lbs (6.4 kgs)

## Performance Data

### LOWEST SPEED

**RPM:** 60  
**CFM:** 1,304  
**Watts:** 2.58  
**CFM/W:** 505

### HIGHEST SPEED

**RPM:** 235  
**CFM:** 5,998  
**Watts:** 34.67  
**CFM/W:** 173

## Energy Guide Data

**Average Energy Use**  
22 Watts

**Average Airflow**  
3,798 CFM

**Yearly Energy Cost**  
\$6

**Average Efficiency**  
172 CFM/Watt

*Energy Guide Data represents weighted averages of low speed and high speed performance, assuming typical use (excluding light). For more information, visit [www.modernfan.com](http://www.modernfan.com).*

# Velo DC

Gloss White with White Blades (no light)



Bright Nickel with Maple Blades (no light)



Dark Bronze with Ebony Blades and 853 LED Light



## FAN FINISHES

Gloss White

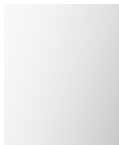

Bright Nickel

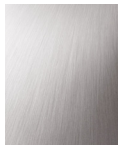

Dark Bronze

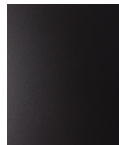

## INJECTION MOLDED BLADES

Injection molded blades are constructed of ABS plastic and painted with solid colors or surface-printed with woodgrain detailing as shown here.

White



Nickel

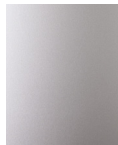

Dark



Ebony

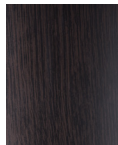

Graywash



Maple



Mahogany

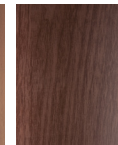

Whitewash



## VELO DC CONTROLS

Our DC fan controls use RF transmission to a receiving unit included with each fan, providing six speeds, reversing and light function (on/off or dimming). Includes universal or dedicated channel selection and master power switch on wall control (if ordered). Control selection is made at time of order and incorporated into fan item number.

### Wall Control (WC)



### Remote Control (RC)



### Wall/Remote Combo (CC)



\* The Velo DC fan must use one of the above control options. Third party fan controls are not compatible with this product. The Remote Control (RC) can be used in combination with a standard power switch (on-off) in wall box.

\*\* For ordering guidance to replace lost or damaged control components or to add secondary control to existing control sets (e.g. to add a handset to an existing wall control system), contact Modern Fan Co. customer support.

## DOWN RODS

The Velo DC ships standard with 4.5" and 12" down rods. Use the following part numbers to order accessory down rods.

#DRD	Finish	Length
-	-	-
▲		▲
<b>GW</b>	Gloss White	12 12"
<b>BN</b>	Bright Nickel	24 24"
<b>DB</b>	Dark Bronze	36 36"
		48 48"
		60 60"
		72 72"

## SLOPE ADAPTER

The Velo DC will accommodate ceiling slopes up to 33 degrees. The #045 slope adapter can accommodate slopes exceeding 33 degrees and up to 45 degrees.

#045	Finish
-	-
▲	
<b>GW</b>	Gloss White
<b>BN</b>	Bright Nickel
<b>DB</b>	Dark Bronze