

Job Name:

System Reference:

Date:

MRCH2



MRCH2 REMOTE CONTROLLER SPECIFICATIONS

- Touch panel, Backlit, easy-to-read display
- Used RedLINK™ 3.0 wireless technology
 - Not compatible with MHK1, MOS1, and MCCH1 RedLINK 2.0 wireless technology environment.
- User functions allow user to set:
 - On/Off
 - Operation modes cool, heat, drying, fan
 - Set temperature (separate dual set points for heat and cool)
 - Fan speed setting
 - Airflow direction
- Set temperature range limits (dependent on the system connected):
 - Cooling from 50° to 99° F
 - Heating from 40° to 90° F
 - Auto from 50° to 90° F with dual temperature setting
- MHK2 Scheduling options:
 - No Schedule
 - MO-SU = Every day the same
 - MO-FR, SA, SU = 5-1-1 schedule
 - MO-FR, SA-SU = 5-2 schedule
 - Each Day = Every day individual
 - Allow kumo cloud to be schedule holder
- Hold function
- Temporary or Permanent schedule override
- Lockout:
 - On
 - Off
 - Mode
 - Fan Speed
 - Set point
 - Vane Direction
- Day/Time display with a 12 or 24-hour clock
- Supports both Fahrenheit and Celsius
- RedLINK™ Wireless Connection Status
- Filter sign display
- Diagnostics: Displays and records error codes
- Adjustable auto mode deadband

- Space temperature offset adjustment
- Space humidity offset adjustment
- Hide (on screen only)
 - Indoor temperature
 - Indoor humidity
- Temperature Sensing Source
 - MHK2
 - Indoor Unit
 - RedLINK Wireless Indoor Air Sensor (IAS)
 - Average of MHK2 and RedLINK Wireless Indoor Air Sensor (IAS)
- Indoor Humidity Source
 - MHK2
 - RedLINK Wireless Indoor Air Sensor (IAS)
 - Average of MHK2 and RedLINK Wireless Indoor Air Sensor (IAS)
- Improved indoor unit function code list
 - Indoor unit type
 - Expanded to 28 indoor unit codes
- Reset to factory default
- Uses two “AA” alkaline batteries (included)
- Dimensions: 4-5/64” x 4-5/64” x 1-1/16” (104 x 104 x 27 mm)
- Operating Ambient Temperature: 32° to 120° F (0° to 48.9° C)
- Operating Relative Humidity: 5% to 90%

MIFH2 WIRELESS RECEIVER SPECIFICATIONS:

- Included in MHK2 Kit
- Mounts next to or near indoor units to allow MRCH2 Remote Controller operation
- Connects to indoor unit control board with MRC2 Cable
- Dimensions: 3-3/32” H x 1-3/4” W x 39/64” D (74.8 x 44.4 x 15.4 mm)
- Operating Ambient Temperature: -40° to 165° F (-40° to 73.9° C)
- Operating Relative Humidity: 5% to 95%

MRC2 CABLE

- Included in MHK2 Kit in the MIFH2 box
- Connects MIFH2 Wireless Receiver to the CN105 connector on indoor unit control board
- Length: 39-23/64" (1 m)

MODEL: MHK2 kumo touch™



kumo cloud & MHK2

- kumo cloud and MHK2 can work together on the same indoor unit with the following devices:
 - Wireless Interface 2
 - PAC-USWHS002-WF-2
 - Wireless Interface 2 has an additional CN105 connector on it
 - MHK2 kit
- Compatibility with indoor units:
 - All CITY MULTI®
 - All P-Series
 - All M-series

Accessories

- Wireless Interface 2 (PAC-USWHS002-WF-2)
- CN105 IT Extender (PAC-WHS01E-E)
- RedLINK 3.0 Wireless Indoor Air Sensor
- Not sold by Mitsubishi Electric Trane HVAC LLC
- Honeywell (C7189R2002-2/U)

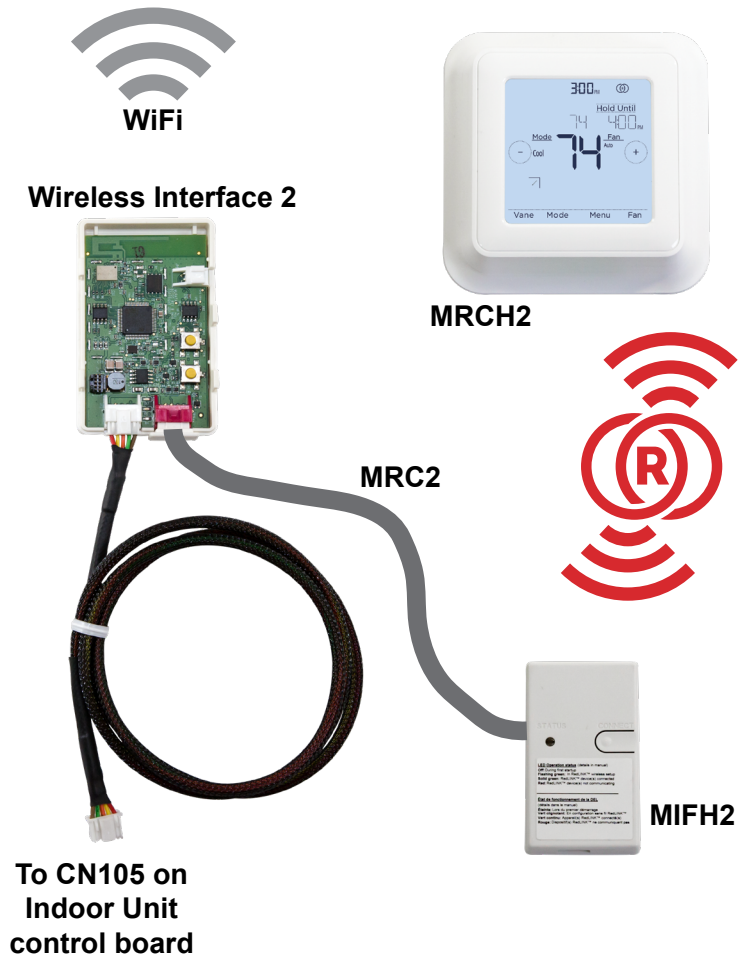

MXZ-3C24NAHZ3 2-TON MULTI-ZONE INVERTER HEAT-PUMP SYSTEM



Job Name:

System Reference:

Date:



FEATURES

- Variable speed INVERTER-driven compressor
- Built-in base pan heater
- Quiet outdoor unit operation as low as 54 dB(A)
- High pressure protection
- Compressor thermal protection
- Compressor overcurrent detection
- Fan motor overheating/voltage protection
- Hyper-heating performance offers 100% heating capacity at 5°F and 90% heating capacity at -13°F
- ENERGY STAR® certified (non-ducted)

ENERGY STAR products are third-party certified by an EPA-recognized Certification Body.

Specifications are subject to change without notice.

© 2022 Mitsubishi Electric Trane HVAC US LLC. All rights reserved.

SPECIFICATIONS: MXZ-3C24NAHZ3

Cooling ¹ (Non-Ducted // Mix // Ducted)	Maximum Capacity	BTU/H	23,600 // 23,600 // 23,600	
	Rated Capacity	BTU/H	22,000 // 22,800 // 23,600	
	Minimum Capacity	BTU/H	12,600 // 12,600 // 12,600	
	Maximum Power Input	W	3,770 // 3,770 // 3,770	
	Rated Power Input	W	1,630 // 1,995 // 2,360	
	Power Factor (208V, 230V)	%	98.5, 98.5 // 98.5, 98.5 // 98.5, 98.5	
Heating at 47°F ² (Non-Ducted // Mix // Ducted)	Maximum Capacity	BTU/H	30,600 // 30,600 // 30,600	
	Rated Capacity	BTU/H	25,000 // 24,800 // 24,600	
	Minimum Capacity	BTU/H	11,400 // 11,400 // 11,400	
	Maximum Power Input	W	4,540 // 4,540 // 4,540	
	Rated Power Input	W	1,725 // 1,809 // 1,871	
	Power Factor (208V, 230V)	%	97.3, 97.3 // 97.6, 97.4 // 97.4, 97.6	
Heating at 17°F ³ (Non-Ducted // Mix // Ducted)	Maximum Capacity	BTU/H	25,000 // 24,800 // 24,600	
	Rated Capacity	BTU/H	14,000 // 14,000 // 14,000	
	Maximum Power Input	W	3,557 // 3,671 // 3,795	
	Rated Power Input	W	1,622 // 1,629 // 1,635	
Heating at 5°F ⁴ (Non-Ducted // Mix // Ducted)	Maximum Capacity	BTU/H	25,000 // 24,800 // 24,600	
	Maximum Power Input	W	3,760 // 3,980 // 4,200	
Efficiency (Non-Ducted // Mix // Ducted)	SEER		19.0 // 17.2 // 15.5	
	EER ¹		13.5 // 11.7 // 10.0	
	HSPF (IV)		10.0 // 9.5 // 9.0	
	COP at 47°F ²		4.25 // 4.02 // 3.8	
	COP at 17°F at Maximum Capacity ³		2.06 // 1.95 // 1.9	
	COP at 5°F at Maximum Capacity ⁴		1.95 // 2.11 // 1.72	
	ENERGY STAR [®] Certified		Yes // No // No	
Electrical	Electrical Power Requirements	Voltage, Phase, Frequency	208/230, 1, 60	
	Guaranteed Voltage Range	V AC	187-253	
	Voltage: Indoor - Outdoor, S1-S2	V AC	208/230	
	Voltage: Indoor - Outdoor, S2-S3	V DC	24	
	Short-circuit Current Rating (SCCR)	kA	5	
	Recommended Fuse/Breaker Size	A	40	
	Recommended Wire Size	AWG	14	
	Minimum Circuit Ampacity	A	30.5	
	Maximum Overcurrent Protection	A	40	
	Fan Motor Full Load Amperage	A	2.43	
Outdoor unit	Airflow Rate (Cooling / Heating)	CFM	2,150 / 2,550	
	Refrigerant Control		LEV	
	Defrost Method		Reverse Cycle	
	Heat Exchanger Type		Plate fin coil	
	Sound Pressure Level, Cooling ¹	dB(A)	54	
	Sound Pressure Level, Heating ²	dB(A)	58	
	Compressor Type		DC INVERTER-driven Twin Rotary	
	Compressor Model		MNB33FBTMC-L	
	Compressor Rated Load Amps	A	20	
	Compressor Locked Rotor Amps	A	28.8	
	Compressor Oil Type // Charge	oz.	FV50S // 37.2	
	Base Pan Heater		Built-in	
	Unit Dimensions	W: In. [mm]		37-13/32 [950]
		D: In. [mm]		13 [330]
		H: In. [mm]		41-17/64 [1,048]
	Package Dimensions	W: In. [mm]		41-3/8 [1,050]
		D: In. [mm]		17-3/8 [440]
		H: In. [mm]		46-3/4 [1,190]
	Unit Weight	Lbs.[kg]		189 [86]
Package Weight	Lbs.[kg]		212 [96]	
Outdoor unit operating temperature range	Cooling Intake Air Temp (Maximum / Minimum ^Δ)	°FDB	115 / 14	
	Cooling Thermal Lock-out / Re-start Temperatures	°FDB	10.4 / 14	
	Heating Intake Air Temp (Maximum / Minimum)	°FWB	65 / -13	
	Heating Thermal Lock-out / Re-start Temperatures	°FDB	-18 / -14	
Refrigerant	Charge	Lbs, oz	8.0, 13.0	
	Chargeless Piping Length	Ft. [m]	98.0 [30.0]	
	Additional Refrigerant Charge Per Additional Piping Length	oz./Ft. [g/m]	0.216 [20]	

NOTES:

AHRI Rated Conditions

(Rated data is determined at a fixed compressor speed)

¹Cooling (Indoor // Outdoor)

²Heating at 47°F (Indoor // Outdoor)

³Heating at 17°F (Indoor // Outdoor)

°F 80 DB, 67 WB // 95 DB, 75 WB

°F 70 DB, 60 WB // 47 DB, 43 WB

°F 70 DB, 60 WB // 17 DB, 15 WB

Conditions

⁴Heating at 5°F (Indoor // Outdoor)

°F 70 DB, 60 WB // 5 DB, 4 WB

*Applications should be restricted to comfort cooling only; equipment cooling applications are not recommended for low ambient temperature conditions.

^Δ 5°F DB - 115°F DB when optional wind baffles are installed

For actual capacity performance based on indoor unit type and number of indoor units connected, please refer to MXZ Operational Performance.

Although the maximum connectable capacity is 130%, the outdoor unit cannot provide more than 100% of the rated capacity. Please utilize this over capacity capability for load shedding or applications where it is known that all connected units will NOT be operating at the same time.

SPECIFICATIONS: MXZ-3C24NAHZ3

Indoor unit connection	Maximum Number of Connected IDU		3
	Minimum Number of Connected IDU		2
	Minimum connected capacity	BTU/H	12,000
	Maximum connected capacity	BTU/H	27,000
Piping	Liquid Pipe Size O.D. (Flared)	In.[mm]	A,B,C: 1/4 [A,B,C: 6.35]
	Gas Pipe Size O.D. (Flared)	In.[mm]	A: 1/2; B,C: 3/8 [A: 12.72; B,C: 9.52]
	Total Piping Length	Ft. [m]	230 [70]
	Maximum Height Difference, ODU above IDU	Ft. [m]	49 [15]
	Maximum Height Difference, ODU below IDU	Ft. [m]	49 [15]
	Farthest Piping Length from ODU to IDU	Ft. [m]	82 [25]
	Maximum Number of Bends for IDU		70

NOTES:

AHRI Rated Conditions (Rated data is determined at a fixed compressor speed)	¹ Cooling (Indoor // Outdoor)	°F	80 DB, 67 WB // 95 DB, 75 WB
	² Heating at 47°F (Indoor // Outdoor)	°F	70 DB, 60 WB // 47 DB, 43 WB
	³ Heating at 17°F (Indoor // Outdoor)	°F	70 DB, 60 WB // 17 DB, 15 WB

Conditions	⁴ Heating at 5°F (Indoor // Outdoor)	°F	70 DB, 60 WB // 5 DB, 4 WB
------------	---	----	----------------------------

*Applications should be restricted to comfort cooling only; equipment cooling applications are not recommended for low ambient temperature conditions.

⁴A 5°F DB - 115°F DB when optional wind baffles are installed

For actual capacity performance based on indoor unit type and number of indoor units connected, please refer to MXZ Operational Performance.

Although the maximum connectable capacity is 130%, the outdoor unit cannot provide more than 100% of the rated capacity. Please utilize this over capacity capability for load shedding or applications where it is known that all connected units will NOT be operating at the same time.

OUTDOOR UNIT ACCESSORIES: MXZ-3C24NAHZ3

Air Outlet Guide	Air Outlet Guide (1 Piece)	PAC-SH96SG-E
Ball Valve	Refrigeration Ball Valve - 1/2"	BV12FFSI2
	Refrigeration Ball Valve - 1/4"	BV14FFSI2
	Refrigeration Ball Valve - 3/8"	BV38FFSI2
	Refrigeration Ball Valve - 5/8"	BV58FFSI2
Drain Socket	Drain Socket	PAC-SG60DS-E
Hail Guards	Hail Guard	HG-A1
M-NET Converter	M-NET Converter	PAC-IF01MNT-E
Mounting Pad	Condensing Unit Mounting Pad: 16" x 36" x 3"	ULTRILITE1
	Outdoor Unit 3-1/4 inch Mounting Base (Pair) - Plastic	DSD-400P
Port Adapter	Adaptor: 1/2" x 3/8"	MAC-A455JP-E
	Adaptor: 1/2" x 5/8"	MAC-A456JP-E
	Adaptor: 3/8" x 1/2"	MAC-A454JP-E
	Adaptor: 3/8" x 5/8"	PAC-SG76RJ-E
Stand	18" Single Fan Stand	QSMS1801M
	24" Single Fan Stand	QSMS2401M
	Condenser Wall Bracket	QSWB2000M-1
	Condenser Wall Bracket - Stainless Steel Finish	QSWBSS
	Outdoor Unit Stand — 12" High	QSMS1201M

OUTDOOR UNIT DIMENSIONS: MXZ-3C24NAHZ3

Unit: inch (mm)

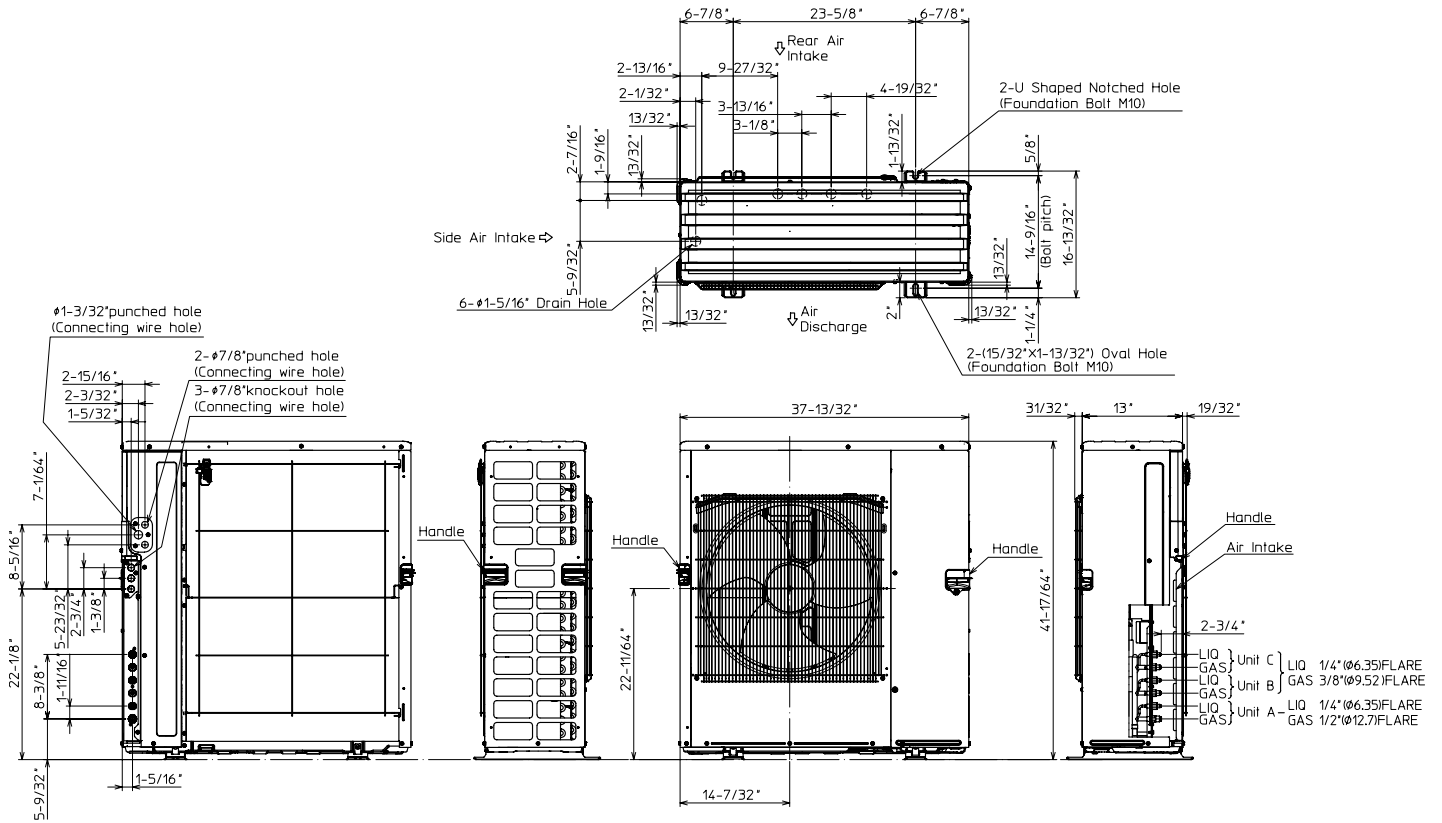

1.FREE SPACE

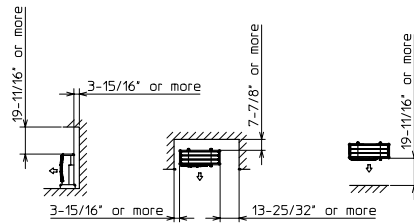

2.SERVICE SPACE

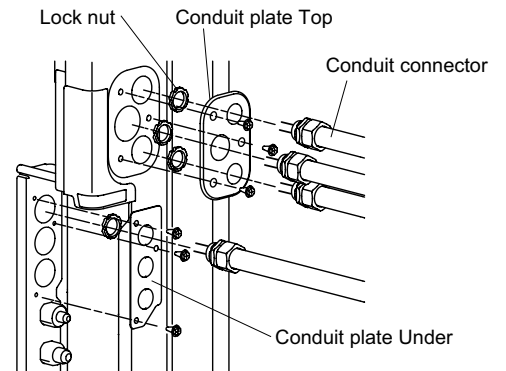
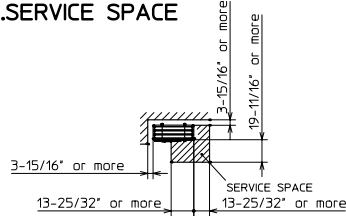

1340 Satellite Boulevard Suwanee, GA 30024
Toll Free: 800-433-4822 www.mehvac.com



SUBMITTAL DATA: SEZ-KD09NA4**

9,000 BTU/H HORIZONTAL-DUCTED INDOOR UNIT FOR MXZ MULTI-ZONE HEAT-PUMP SYSTEMS

Job Name:

System Reference:

Date:

****APPLIES TO INDOOR UNIT:**

- SEZ-KD09NA4
- SEZ-KD09NA4.TH
- SEZ-KD09NAR1.TH
- SEZ-KD09NA4R1.TH

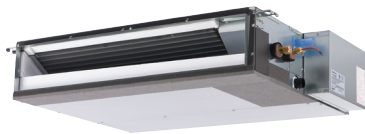

Indoor Unit: SEZ-KD09NA4**

GENERAL FEATURES

- Horizontal-ducted indoor unit for concealed applications
- Ultra thin body: 7-7/8" high
- Built-in drain mechanism for condensate removal; lifts to 21-11/16"
- Air filter is included with indoor unit
- Quiet operation — as low as 23 dBA
- Indoor unit powered from outdoor unit using A-Control
- AUTO fan speed control
- Automatic restart following a power outage
- Limited warranty: five years parts and seven years compressors

ACCESSORIES

Indoor Unit

- Filter Box with MERV 8 Filters (FBL1-1)
- Bottom Return Plate (BRP-1)

Controller Options

- Wireless Wall-mounted Remote Controller Kit (MHK1)*
- Portable Central Controller (MCCH1)*
- Outdoor Air Sensor (MOS1)*
- Wired Wall-mounted Controller (PAR-31MAA)*
- Simple MA Remote Controller (PAC-YT53CRAU)*

*See Submittal for information on each option.

- Remote Temperature Sensor (M21-JKO-307)
- Hand-held Wireless Remote Controller (PAR-FL32MA;req.PAR-FA32MA-E)
- Wireless Signal Receiver PAR-FA32MA (for PAR-FL32MA)
- Lockdown Bracket for Hand-held Controller (RCMKP1CB)

SPECIFICATIONS

Cooling Capacity* 8,100 Btu/h
Heating Capacity at 47°F* 10,900 Btu/h

*** Rating Conditions per AHRI Standard**

Cooling | Indoor: 80° F (27° C) DB / 67° F (19° C) WB
Cooling | Outdoor: 95° F (35° C) DB / 75° F (24° C) WB
Heating at 47°F | Indoor: 70° F (21° C) DB / 60° F (16° C) WB
Heating at 47°F | Outdoor: 47° F (8° C) DB / 43° F (6° C) WB

(For data on specific indoor units [all ducted, all non-ducted, and both ducted and non-ducted] combinations, see the MXZ Technical and Service Manual.)

Electrical Requirements

Power Supply 208 / 230V, 1-Phase, 60 Hz
MCA 1 A

Voltage

Indoor - Outdoor S1-S2 AC 208 / 230V
Indoor - Outdoor S2-S3 DC ±24V

Blower Motor (ECM) 0.51 F.L.A.

Airflow (Lo - Med - Hi)

Cooling 194 - 247 - 317 Dry CFM
174 - 222 - 285 Wet CFM
Heating 194 - 247 - 317 CFM

Sound Pressure Level (Lo - Med - Hi)

Cooling 23 - 26 - 30 dB(A)
Heating 23 - 26 - 30 dB(A)

DIMENSIONS	UNIT INCHES / MM
W	31-1/8 / 790
D	27-9/16 / 700
H	7-7/8 / 200

Weight 42 lbs. / 19 kg
External Finish Galvanized-steel Sheets
Field Drainpipe Size O.D. 1-1/4" / 32 mm

Refrigerant Type R410A
Refrigerant Pipe Size O.D.
Gas Side 3/8" / 9.52 mm
Liquid Side 1/4" / 6.35 mm
Connection Method Flared



SEZ-KD09NA4** INDOOR FAN PERFORMANCE AND CORRECTED AIR FLOW CHARTS

SEZ-KD09NA4**

(External static pressure 0.02[in.WG](5P a) 208/230V 60Hz

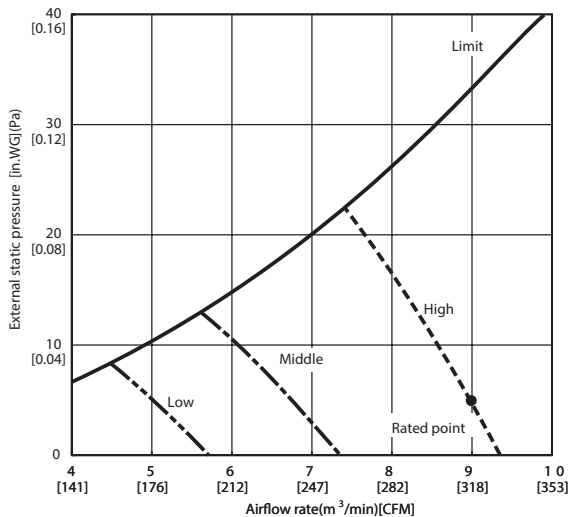

SEZ-KD09NA4**

(External static pressure 0.06[in.WG](15P a) 208/230V 60Hz

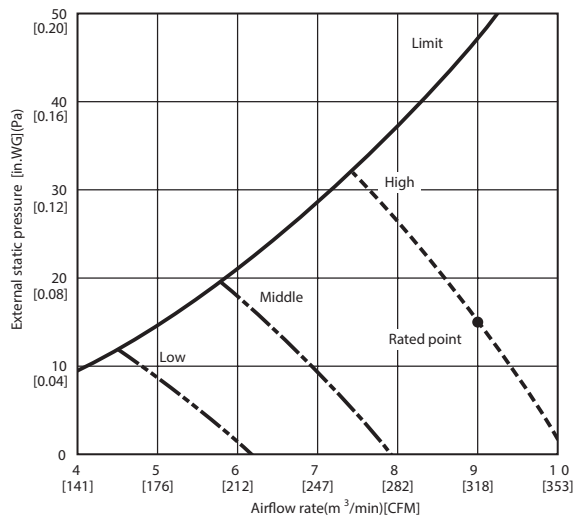

SEZ-KD09NA4**

(External static pressure 0.14[in.WG](35P a) 208/230V 60Hz

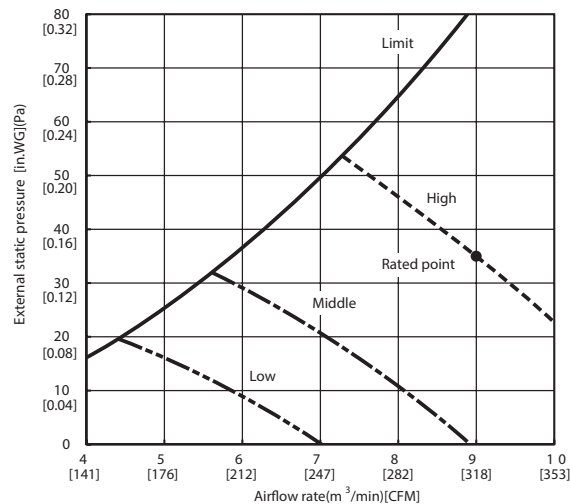

SEZ-KD09NA4**

(External static pressure 0.20[in.WG](50P a) 208/230V 60Hz

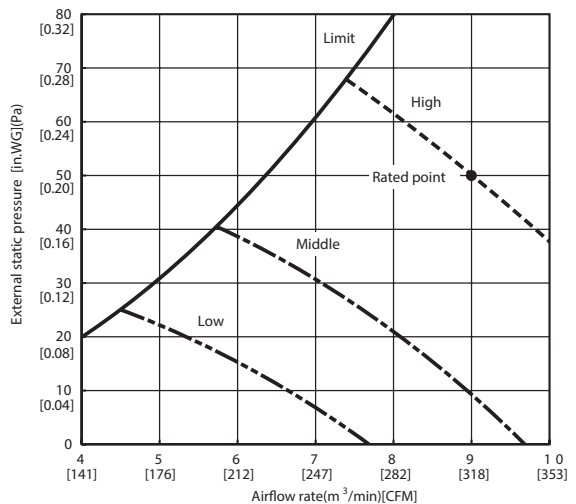

DIMENSIONS: SEZ-KD09NA4**

Unit : mm(in.)

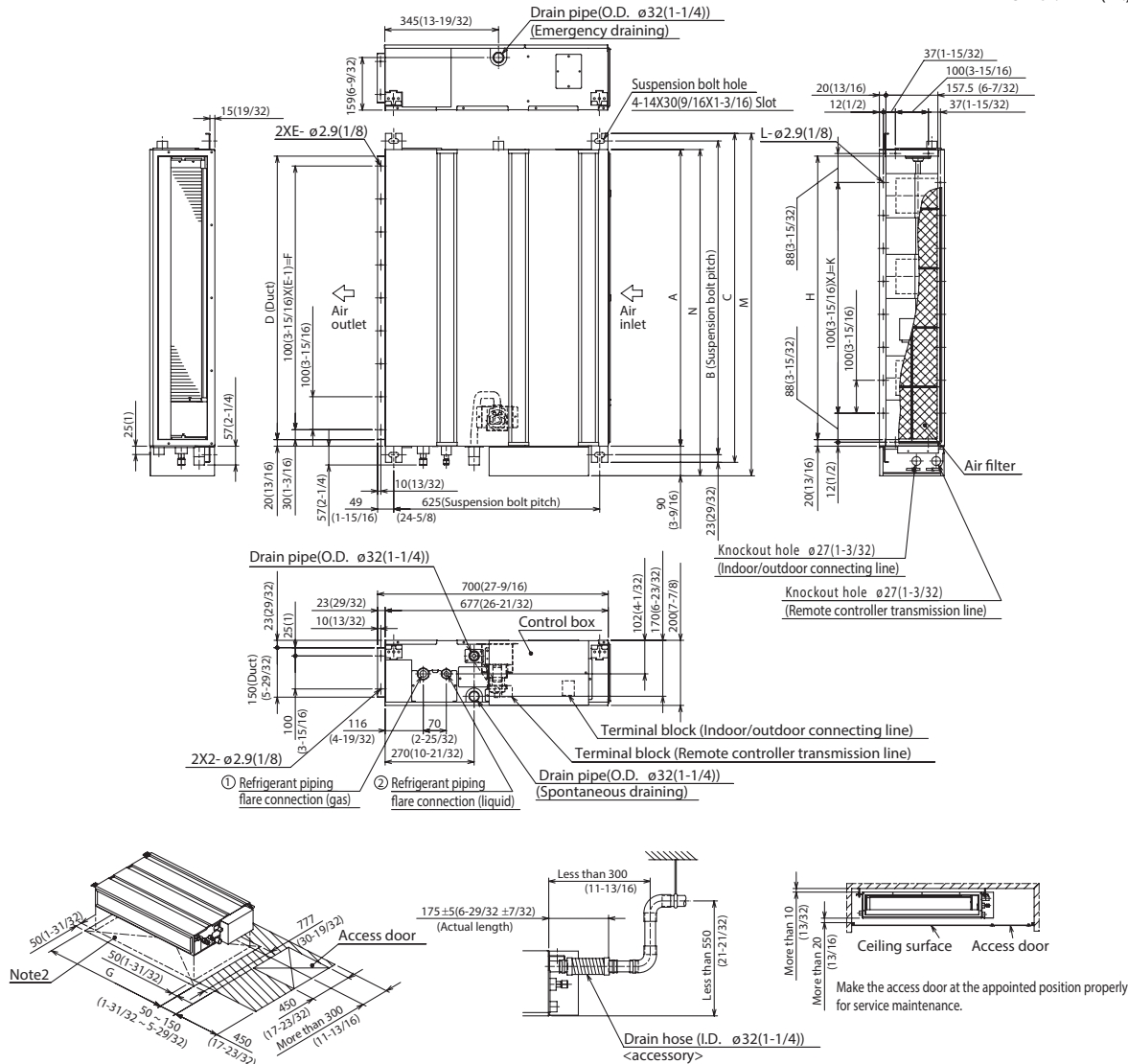

Required space for service and maintenance

Model	mm(in.)															
	A	B	C	D	E	F	G	H	J	K	L	M	N	① Gas pipe	② Liquid pipe	
SEZ-KD09NA4**	700 (27-9/16)	752 (29-5/8)	798 (31-7/16)	660 (26)	7	600 (23-5/8)	800 (31-1/2)	660 (26)	5	500 (19-11/16)	16	839 (33-1/16)	790 (31-1/8)	ø9.52(3/8)	ø6.35(1/4)	
SEZ-KD12NA4**	900 (35-7/16)	952 (37-1/2)	998 (39-5/16)	860 (33-7/8)	9	800 (31-1/2)	1000 (39-3/8)	860 (33-7/8)	7	700 (27-9/16)	20	1039 (40-29/32)	990 (39)			
SEZ-KD15NA4**	1100 (43-5/16)	1152 (45-3/8)	1198 (47-3/16)	1060 (41-3/4)	11	1000 (39-3/8)	1200 (47-1/4)	1060 (41-3/4)	9	900 (35-7/16)	24	1239 (48-25/32)	1190 (46-7/8)	ø12.7(1/2)		
SEZ-KD18NA4**																

- Note1. Use M10 screw for the suspension bolt (field supply).
 2. Keep the service space for the maintenance at the bottom.
 3. This chart indicates for SEZ-KD15NA4** model, which has 3 fans.
 SEZ-KD09, 12NA4** models have 2 fans.
 SEZ-KD18NA4** models have 4 fans.
 4. In case an inlet duct is used, remove the air filter (supply with the unit), then install the filter (field supply) at suction side.



COOLING & HEATING

1340 Satellite Boulevard
 Suwanee, GA 30024
 Toll Free: 800-433-4822
 www.mehvac.com

SEZ-KD15NA4** INDOOR FAN PERFORMANCE AND CORRECTED AIR FLOW CHARTS

SEZ-KD15NA4

(External static pressure 0.02[in.WG](5Pa)) 208/230V 60Hz

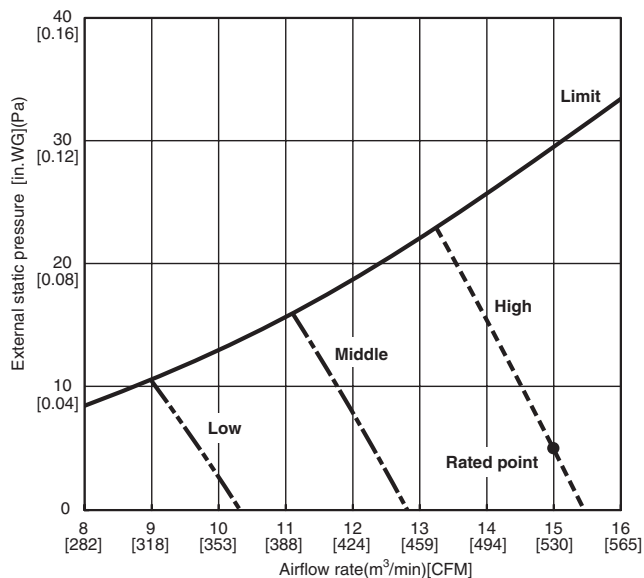

SEZ-KD15NA4

(External static pressure 0.06[in.WG](15Pa)) 208/230V 60Hz

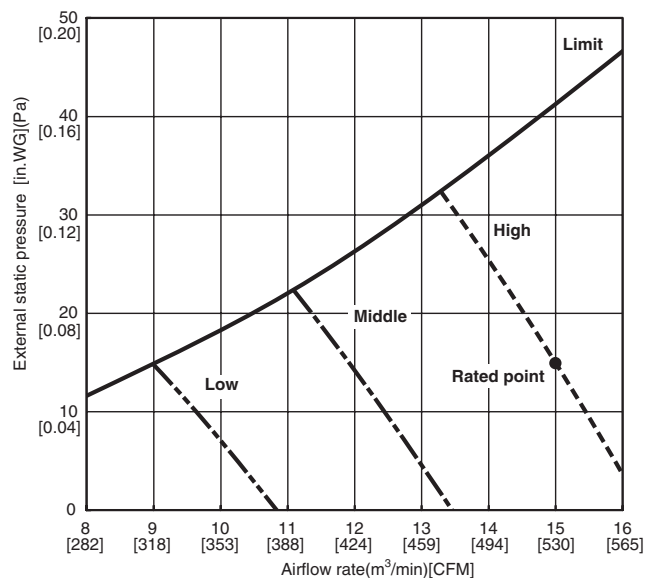

SEZ-KD15NA4

(External static pressure 0.14[in.WG](35Pa)) 208/230V 60Hz

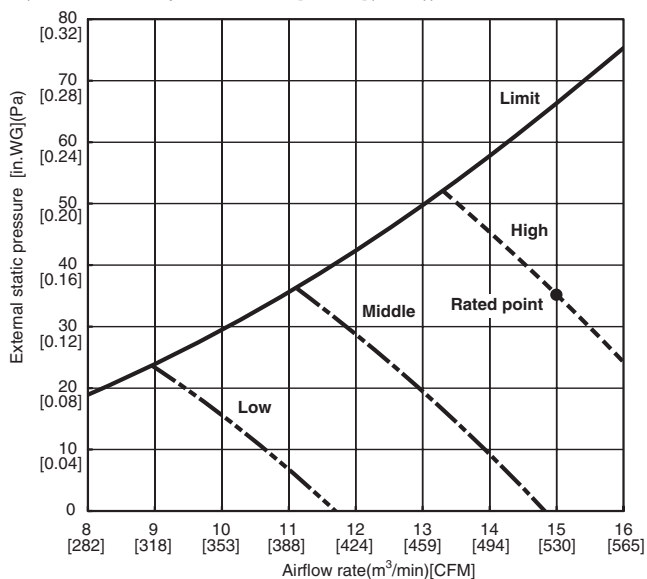

SEZ-KD15NA4

(External static pressure 0.20[in.WG](50Pa)) 208/230V 60Hz

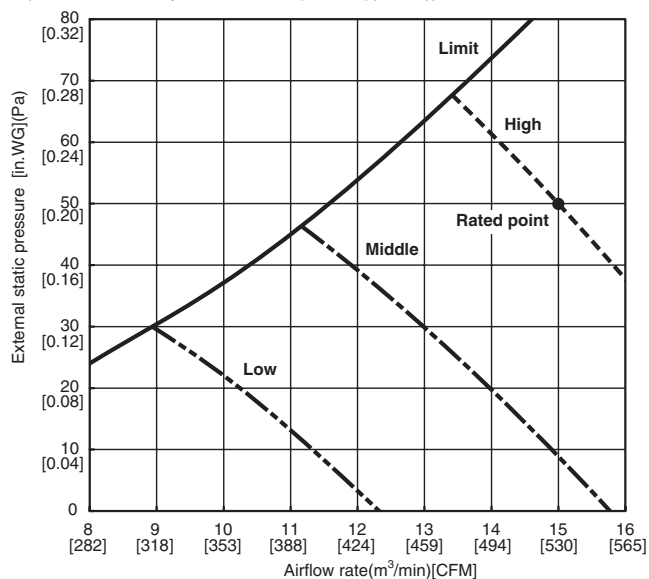

DIMENSIONS: SEZ-KD15NA4**

Unit : mm(in.)

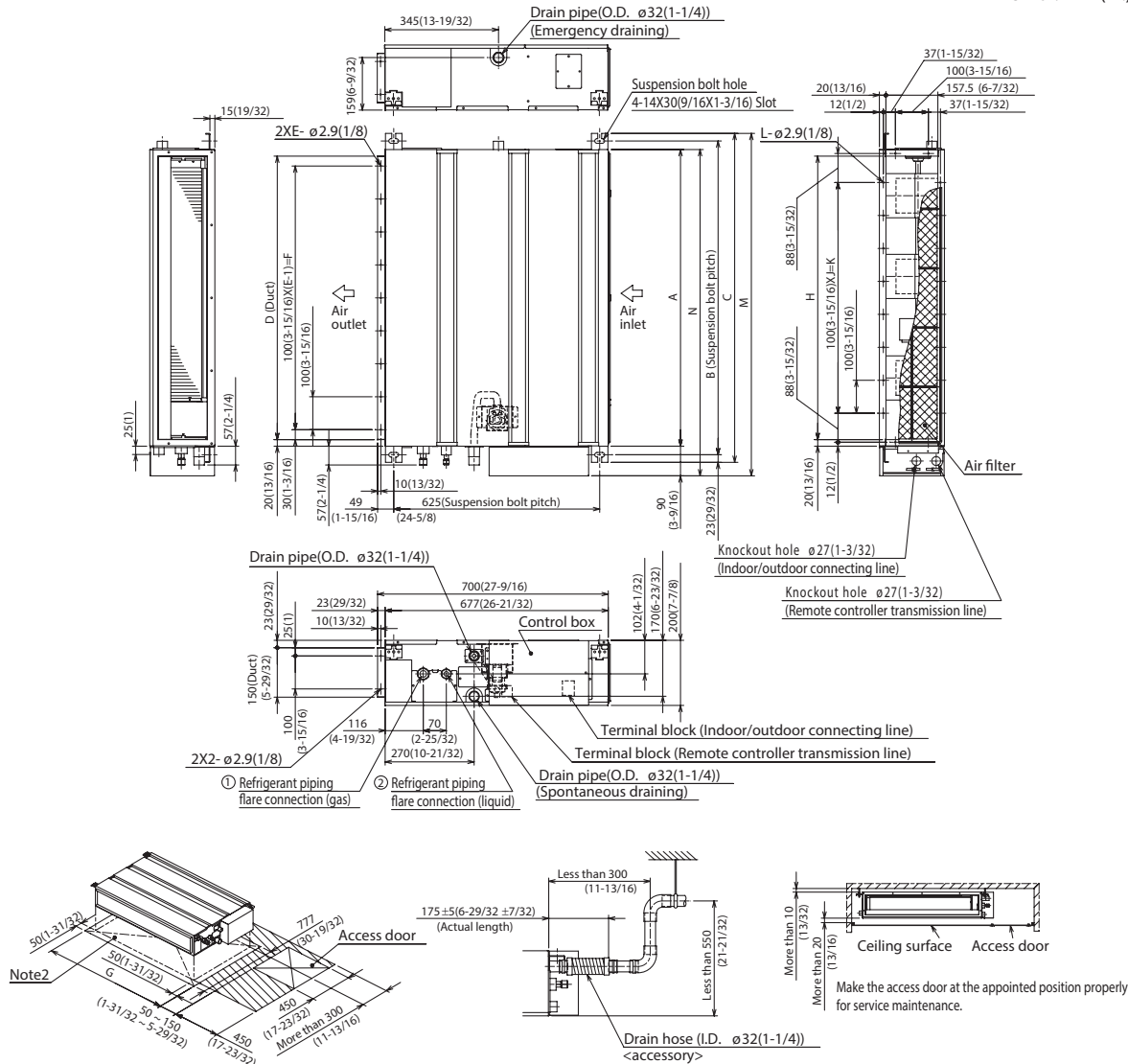

Required space for service and maintenance

Model	mm(in.)															
	A	B	C	D	E	F	G	H	J	K	L	M	N	① Gas pipe	② Liquid pipe	
SEZ-KD09NA4**	700 (27-9/16)	752 (29-5/8)	798 (31-7/16)	660 (26)	7	600 (23-5/8)	800 (31-1/2)	660 (26)	5	500 (19-11/16)	16	839 (33-1/16)	790 (31-1/8)	$\phi 9.52(3/8)$	$\phi 6.35(1/4)$	
SEZ-KD12NA4**	900 (35-7/16)	952 (37-1/2)	998 (39-5/16)	860 (33-7/8)	9	800 (31-1/2)	1000 (39-3/8)	860 (33-7/8)	7	700 (27-9/16)	20	1039 (40-29/32)	990 (39)	$\phi 12.7(1/2)$	$\phi 6.35(1/4)$	
SEZ-KD15NA4**	1100 (43-5/16)	1152 (45-3/8)	1198 (47-3/16)	1060 (41-3/4)	11	1000 (39-3/8)	1200 (47-1/4)	1060 (41-3/4)	9	900 (35-7/16)	24	1239 (48-25/32)	1190 (46-7/8)	$\phi 12.7(1/2)$	$\phi 6.35(1/4)$	

- Note1. Use M10 screw for the suspension bolt (field supply).
 2. Keep the service space for the maintenance at the bottom.
 3. This chart indicates for SEZ-KD15NA4** model, which has 3 fans.
 SEZ-KD09, 12NA4** models have 2 fans.
 SEZ-KD18NA4** models have 4 fans.
 4. In case an inlet duct is used, remove the air filter (supply with the unit), then install the filter (field supply) at suction side.



COOLING & HEATING

1340 Satellite Boulevard
 Suwanee, GA 30024
 Toll Free: 800-433-4822
 www.mehvac.com