

SHOWER ENCLOSURE HANGING WHEEL SLIDING DOOR INSTALLATION INSTRUCTIONS

312052+36P-BN/MB/BG
312056+36P-BN/MB/BG
312060+36P-BN/MB/BG
312064+36P-BN/MB/BG
312068+36P-BN/MB/BG

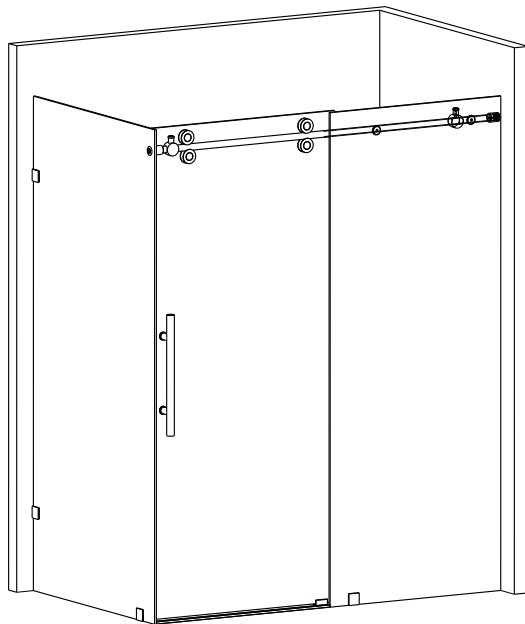

IMPORTANT-Please read and follow all warnings and instructions before using this product. Injury can result from improper use. Save this documents.



WARNING
Tempered Glass, please don't hit the corners and the surrounding, otherwise the glass will burst.



● General Information

Please inspect the product immediately upon receipt for transit damage, missing packs/parts or manufacturing fault. Damage reported later cannot be accepted. Please handle the product with care avoiding knocks and shock loading to all sides and edges of the glass.

Notes: Safety glass can not be re-worked.

Please read these instructions carefully before start of installation.

Special care should be taken when drilling walls to avoid hidden pipes or electrical cables.

Note: This product is heavy and may require two people to install.

Aftercare instructions

After use, your shower should be cleaned with soap and water. This is particularly important in hard water districts where insoluble lime salts may be deposited and allowed to build up. Cleaners of a gritty or abrasive nature should not be used. Care should be taken to avoid contact with strong chemicals such as organic solvents and strippers.

Glass cleaners can be used but with caution, if in doubt contact the manufacturer of the cleaner in question.

Please keep these instructions for aftercare and customer service details.

● Installation Explosive View

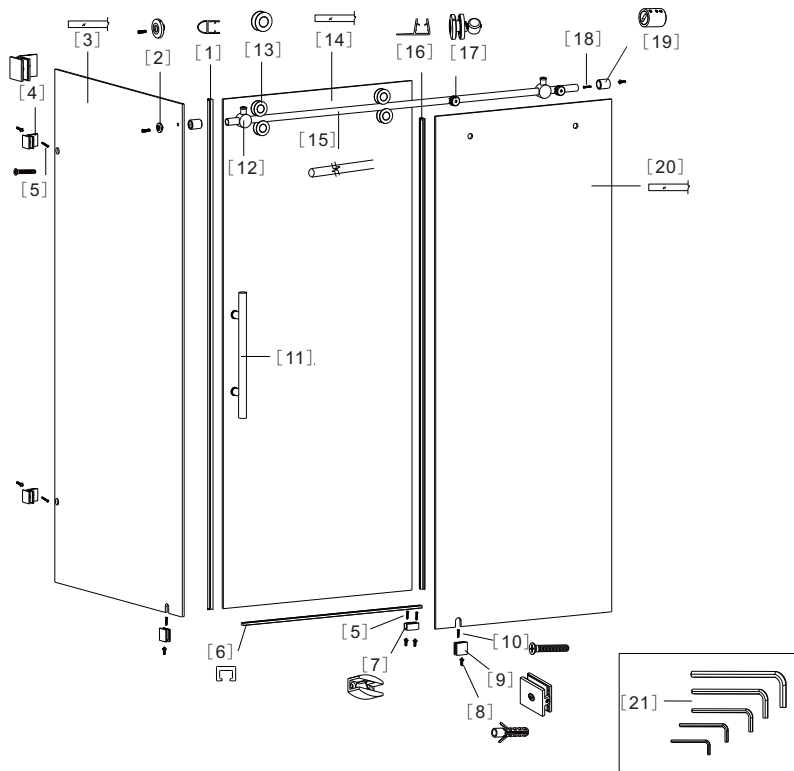

- | | |
|---------------------------|----------------------------|
| [1] Bumper Strip | [11] Handle |
| [2] Fixed Tip | [12] Glass Door Stopper |
| [3] Side Panel | [13] Roller |
| [4] Wall Brace | [14] Glass Door |
| [5] Screw M5X30 | [15] Upper Guide Rail |
| [6] Anti-splash Threshold | [16] Side Anti-Water Strip |
| [7] Guide Block | [17] Glass Bracket |
| [8] Wall Anchor | [18] Screw M5X60 |
| [9] Floor Brace | [19] Guide Rail Bracket |
| [10] Screw M4X30 | [20] Fixed Panel |
| | [21] Allen Key |

● Side Panel Box Contents:

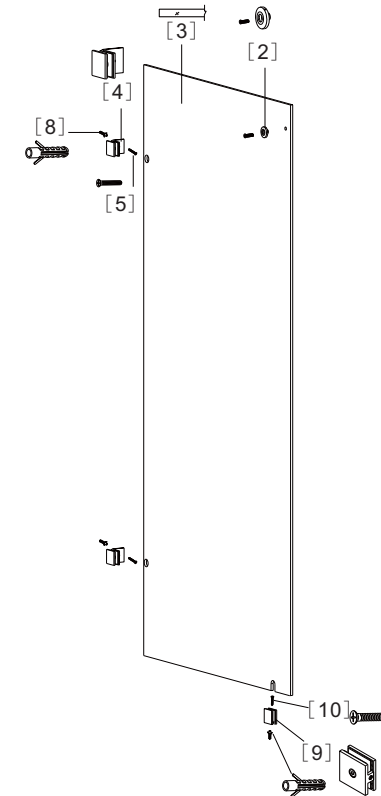

[2] 1X Fixed Tip	➔	
[3] 1X Side Panel	➔	
[4] 2X Wall Brace	➔	
[5] 2X Screw M5X30	➔	
[8] 3X Wall Anchor	➔	
[9] 1X Floor Brace	➔	
[10] 1X Screw M4X30	➔	



● Assembly

01

WARM TIPS

01:

Open the packaging carefully and inspect all the necessary parts using detailed diagram and component list in your manual as a reference. Before discarding the carton, check for small hardware bags that tend to fall to the bottom of the box. If any parts are damaged or missing, please contact us for replacement.

02:

Retain these installation instructions for future use if in need.

1. Measure the distance between two finished walls. This distance is marked as W.

Please see Fig a for details:

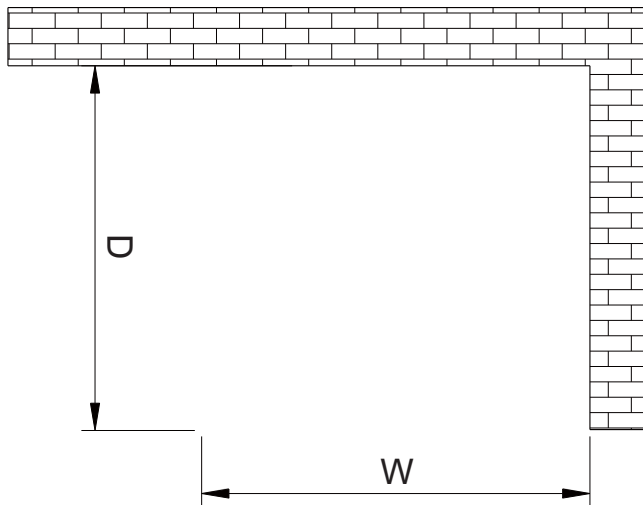

02

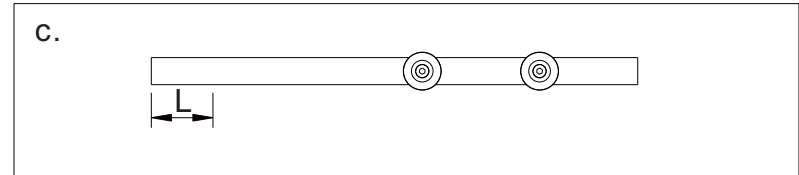
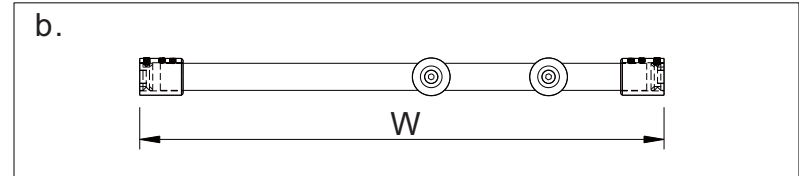
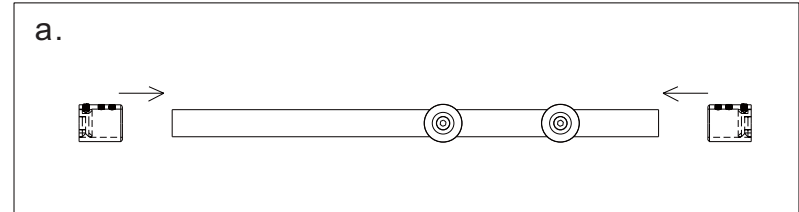





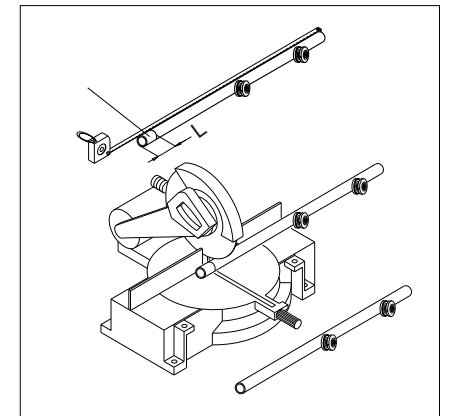

1. Your Upper Guide Rail (04) has been precut for your Shower model opening width, eg. 60" for shower width.
 If W-width of your wall-to-wall opening is equal to the size of your Shower model, it is unnecessary to cut the Upper Guide Rail and you can continue to Step 3.

If W-width of your wall-to-wall opening is less than the size of your Shower model, you will need to cut the Upper Guide Rail from the end which is farther from the Glass brackets (17) holes.
 The length to cut off will be L:
 $L = \text{Subtract } W \text{ from the size of your Shower model.}$

FOR EXAMPLE
 If your wall opening W=59". Your shower model is 60".
 $L = 60 - 59 = 1"$
 You have to cut 1" off from the rail.





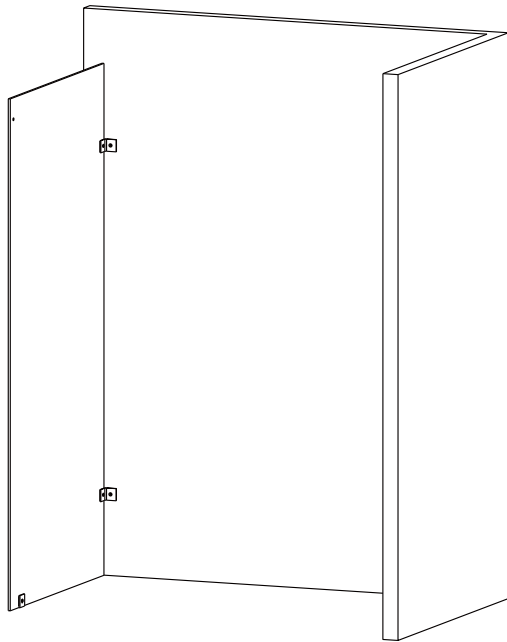

03

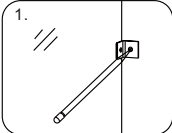
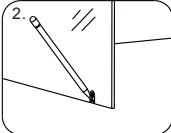
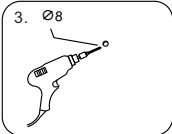
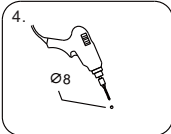
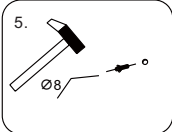
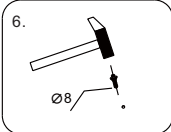
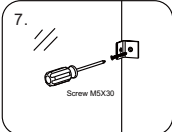
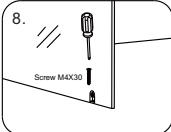
[4]		2X
[5]		2X
[9]		1X
[10]		1X
[8]		3X
[3]		1X





1. 
2. 
3. 
4. 
5. 
6. 
7. 
8. 

04

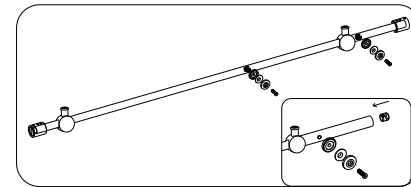
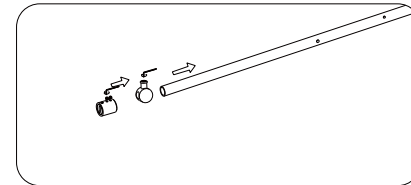
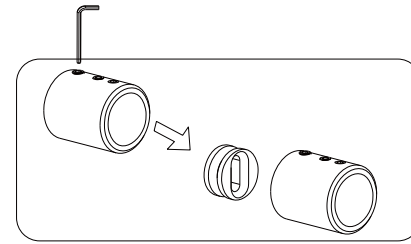
[19]		2X
[17]		2X
[12]		2X
[15]		1X





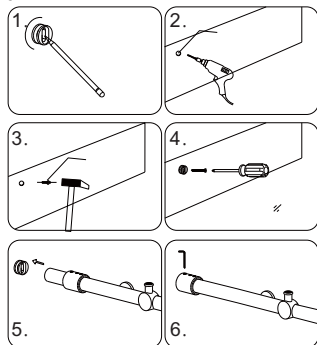
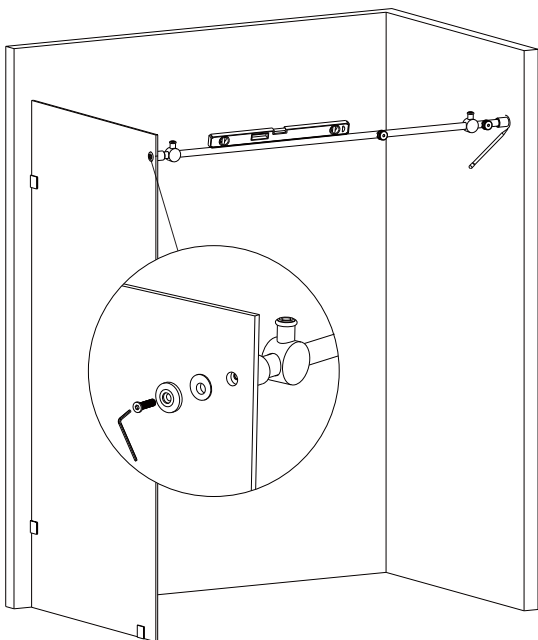

05

[2]		1X
[18]		1X
[8]		1X



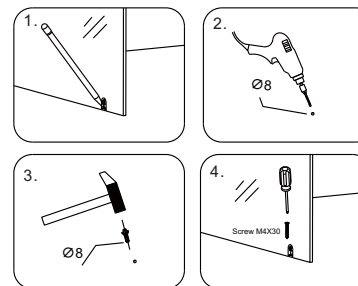
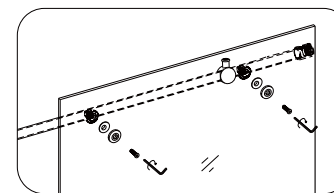
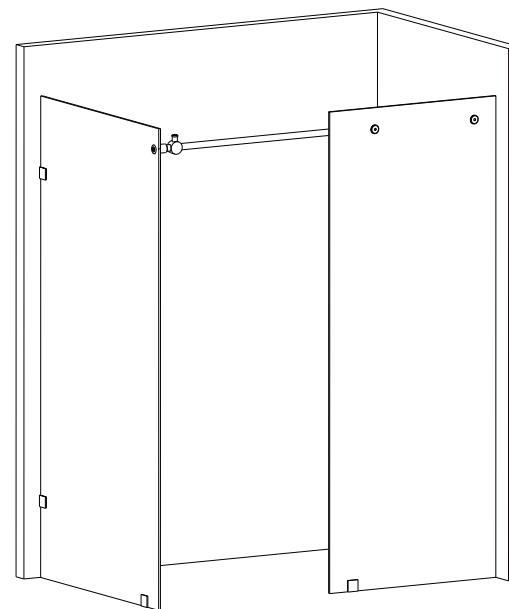

06

[20]		1X
[10]		1X
[8]		3X
[9]		1X



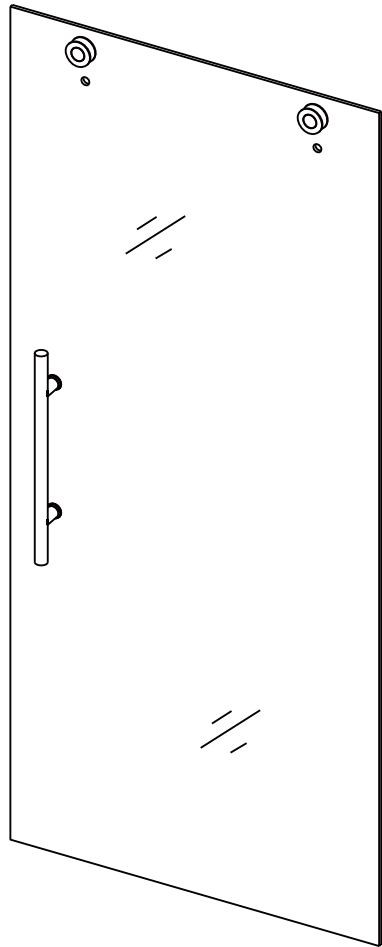
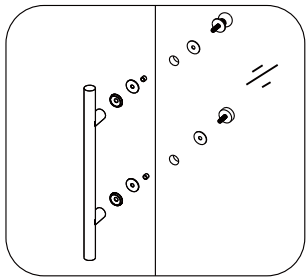
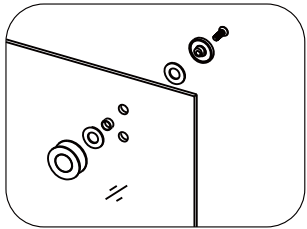
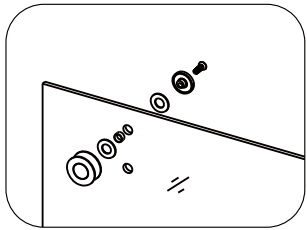

07

[13]	 2X
[11]	 1X
[14]	 1X



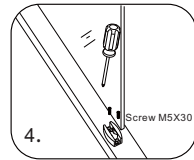
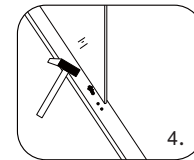
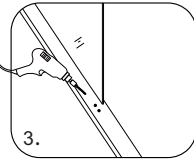
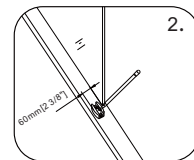
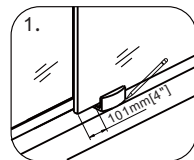
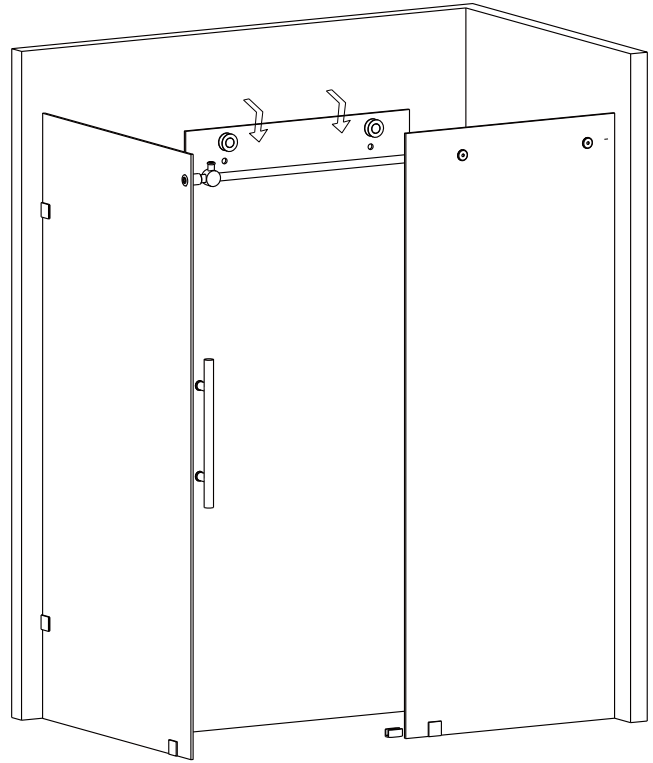

08

[7]	 1X
[5]	 2X
[8]	 2X



09

[1]		1X
[16]		1X
[13]		2X

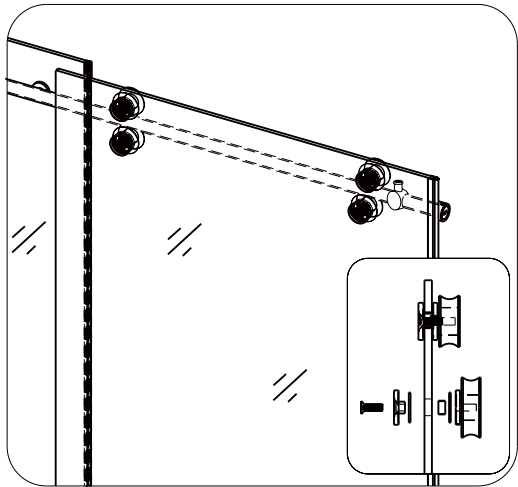
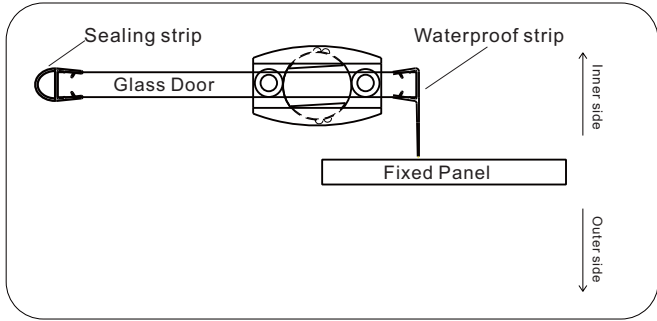

10

[6]		1X
-----	---	----

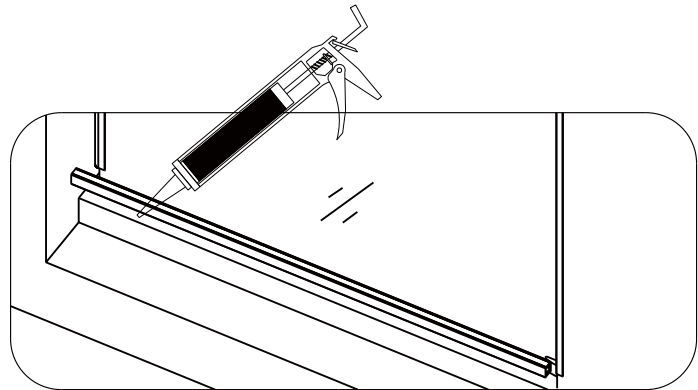
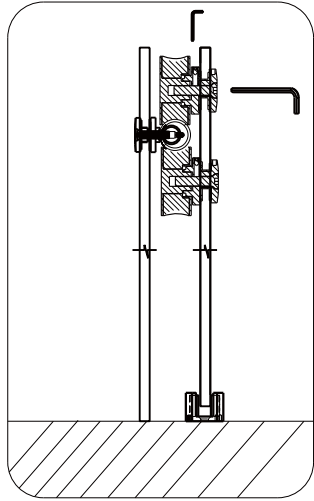
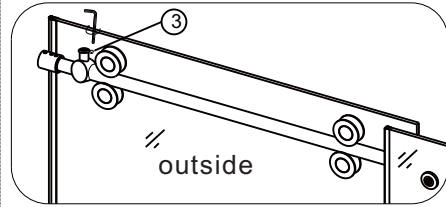
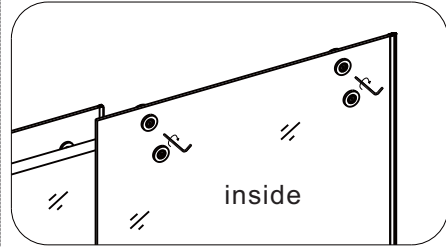

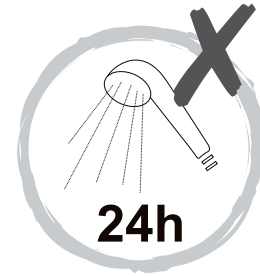
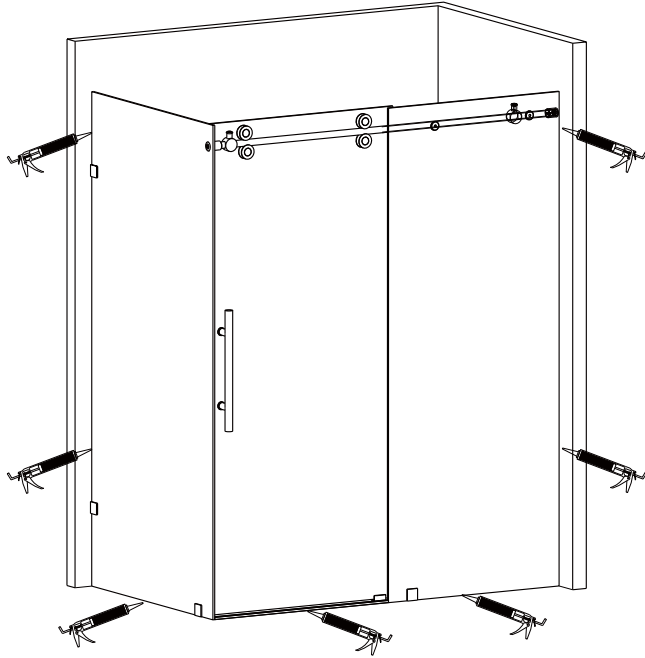

Please ensure the bottom horizontal is straight before the silicone sealant to cure fully



Do not use the shower enclosure for at least 24 hour in order to allow the silicone sealant to cure fully.