

## INSTALLATION SPECIFICATION

Item No.	301068+36P-BG
Combination	301068-BP-BG + 301036-SP-BG
Description	By-pass&Side Panel
Overall Dimensions	36"x68"x76"(with tray)
Installation Size Range	35"-35 4/5" & 64 7/10"-68 6/10"(shower door only)
Profile Color	Brushed Gold
Glass Thickness	8/25"
Glass Color	Transparent&Easy clean
Gross Weight	84 LBS & 162 LBS
Certifications	ANSI Z97.1-2015

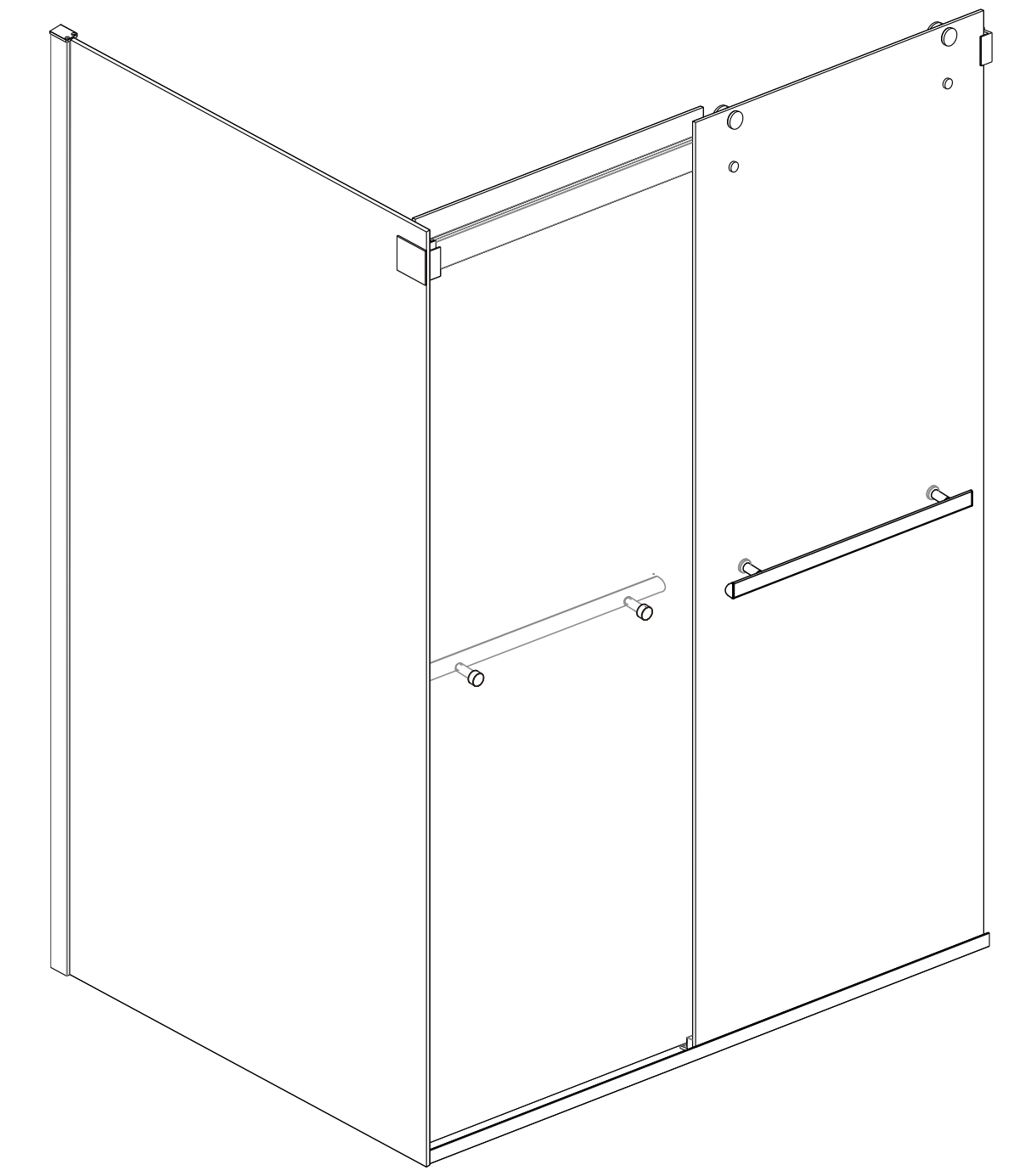

**Spezia**  
By-pass&Side Panel

*All measurements are approximate. Measurements may vary +/- 1/25".*

