

INSTALLATION SPECIFICATION

Item No.	321048+36P-MB
Combination	321048-SS-MB + 321036-SP-MB
Description	Single sliding&Side Panel
Overall Dimensions	36"x48"x78"
Installation Size Range	35"-35 4/5" & 44 2/5"-48 3/10"
Profile Color	Matte Black
Glass Thickness	2/5"&8/25"
Glass Color	Grey&Easy clean
Gross Weight	150 LBS & 86 LBS
Certifications	ANSI Z97.1-2015

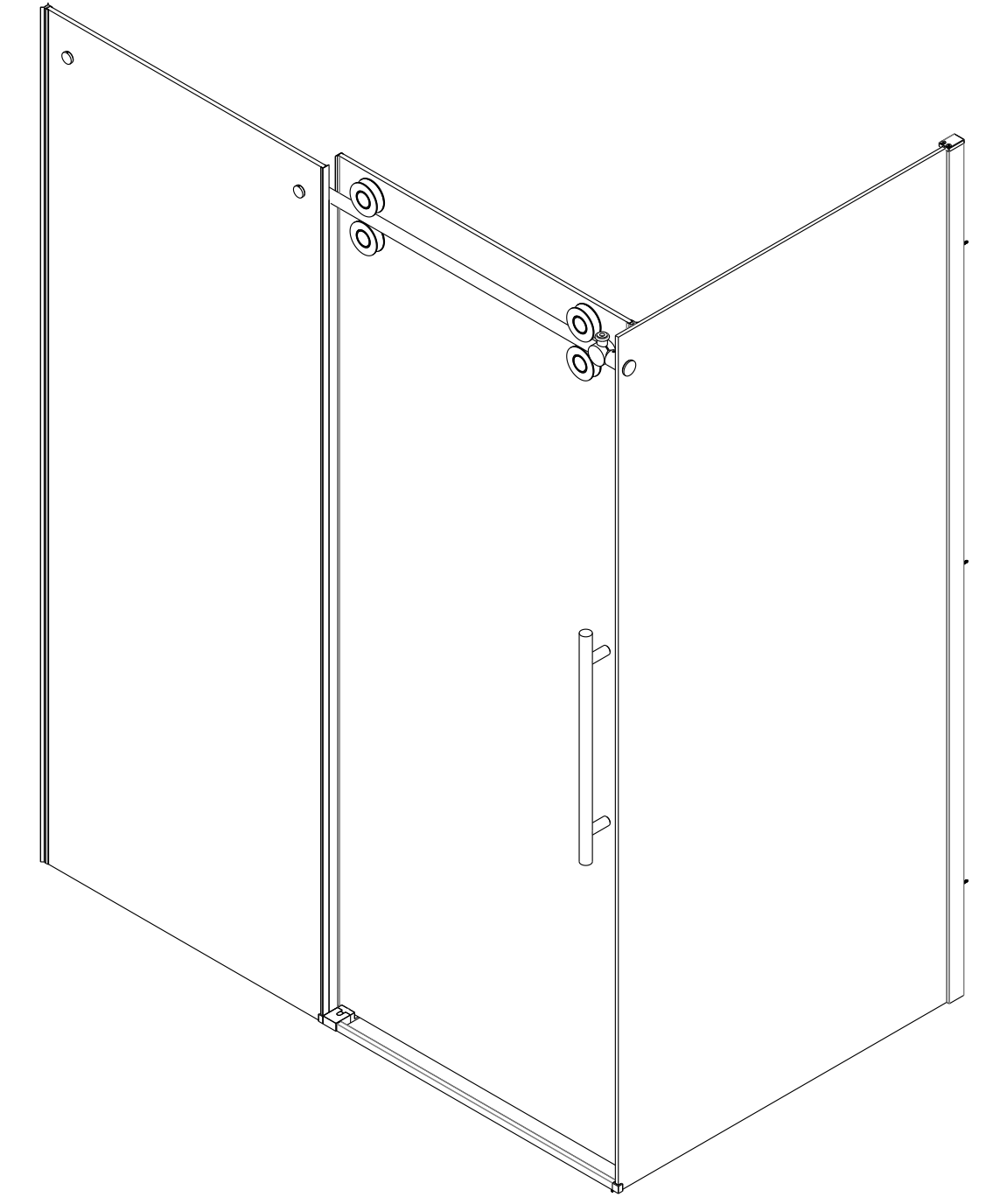

Echarri
Single sliding&Side Panel

All measurements are approximate. Measurements may vary +/- 1/25".

