

## INSTALLATION SPECIFICATION

Item No.	301064-BP-BG
Description	By-pass
Overall Dimensions	64"x76"
Installation Size Range	60"-64"
Profile Color	Brushed Gold
Glass Thickness	8/25"
Glass Color	Transparent&Easy clean
Gross Weight	156 LBS
Certifications	ANSI Z97.1-2015

*All measurements are approximate. Measurements may vary +/- 1/25".*

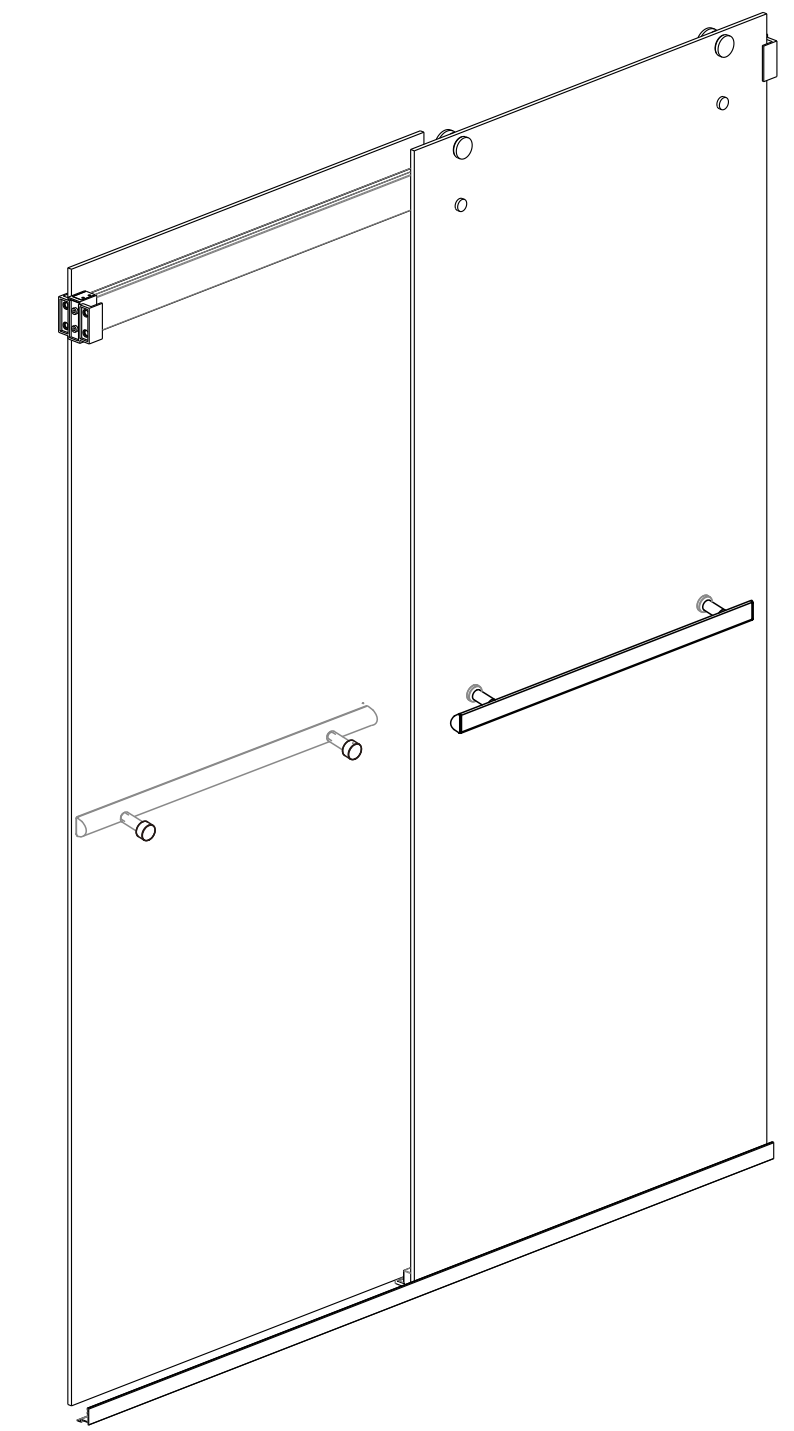

**Spezia  
By-pass**

