

INSTALLATION SPECIFICATION

Item No.	301060-BP-BG
Description	By-pass
Overall Dimensions	60"x76"
Installation Size Range	56"-60"
Profile Color	Brushed Gold
Glass Thickness	8/25"
Glass Color	Transparent&Easy clean
Gross Weight	147 LBS
Certifications	ANSI Z97.1-2015

All measurements are approximate. Measurements may vary +/- 1/25".

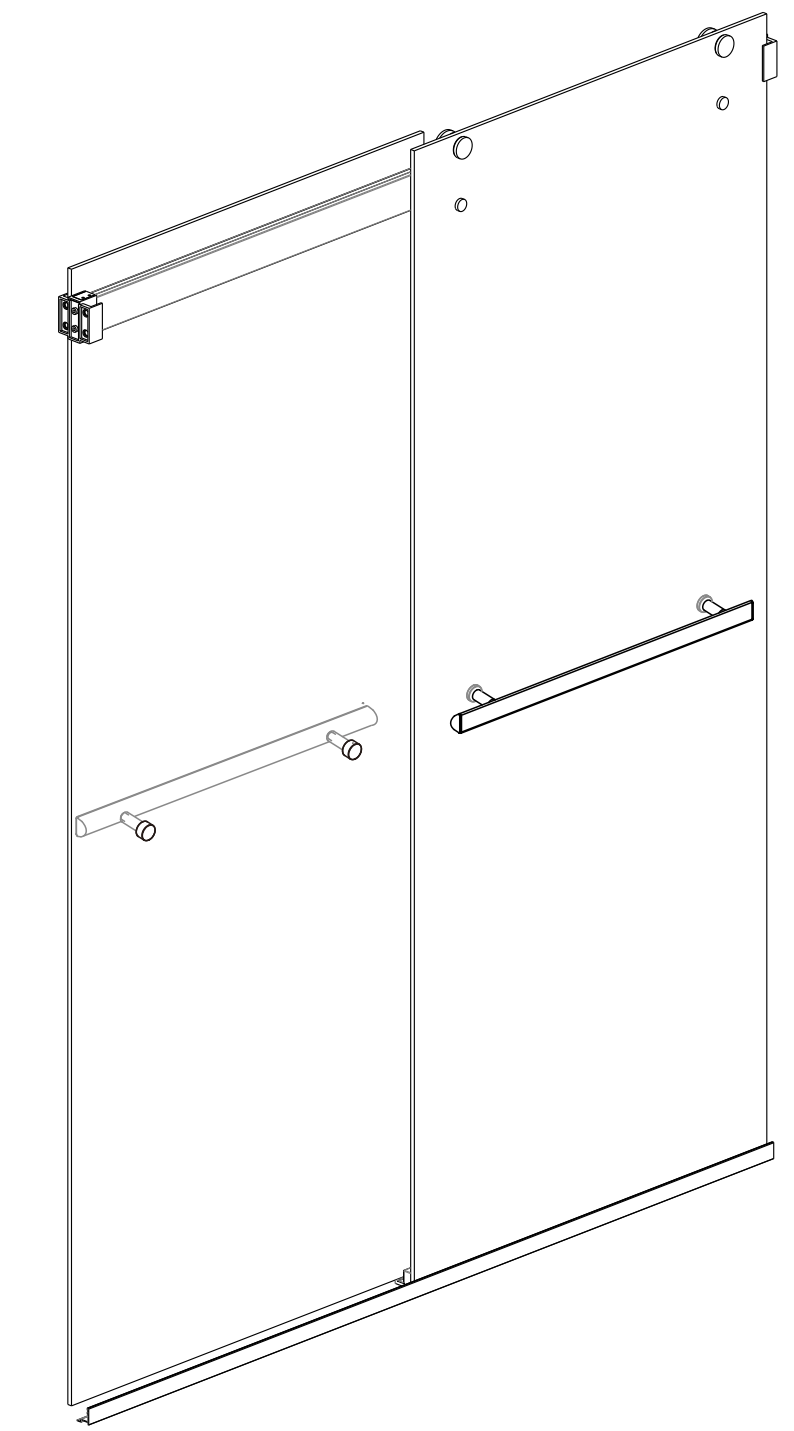

**Spezia
By-pass**

