

**\*INSTALLING VANITY WITH TWO PEOPLE IS HIGHLY RECOMMENDED\***  
**\*L'INSTALLATION DE LA VANITÉ AVEC DEUX PERSONNES EST FORTEMENT RECOMMANDÉE\***

**Recommended Tools/Outils recommandés**

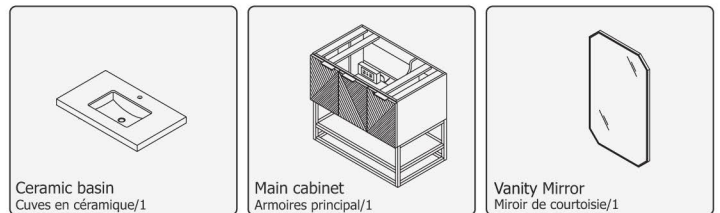

**Main Body Parts/La partie principale du corps**



**Assembly instructions/Instructions de montage**

**STEP #1**  
**Adjusting cabinet foot/**  
**Pieds de cabinet de réglage**

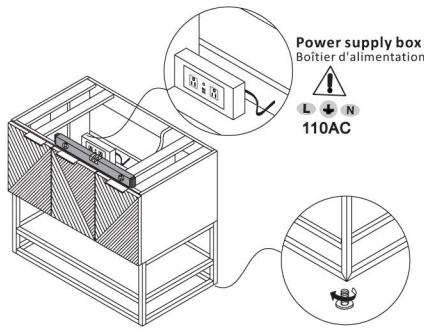

**STEP #2**  
**Paste the countertop/**  
**Coller le comptoir**

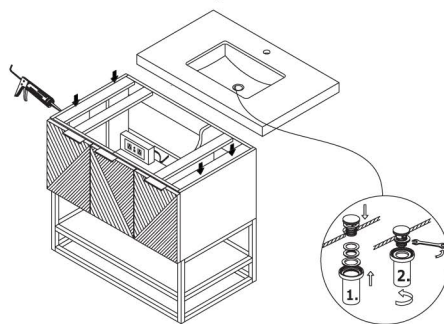

**STEP #3**  
**Hang the mirror/**  
**Accrocher le miroir**

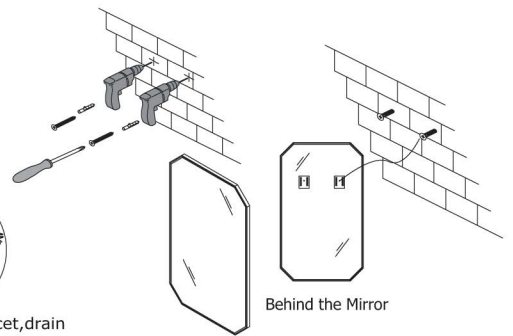

\*Does not include faucet, drain assembly, or P-trap/ Les robinets, les ensembles de drains ou les pièges à eau Le P - trap sont pas inclus.

**Installation, Removal and Adjustment of Hinges on Vanity**

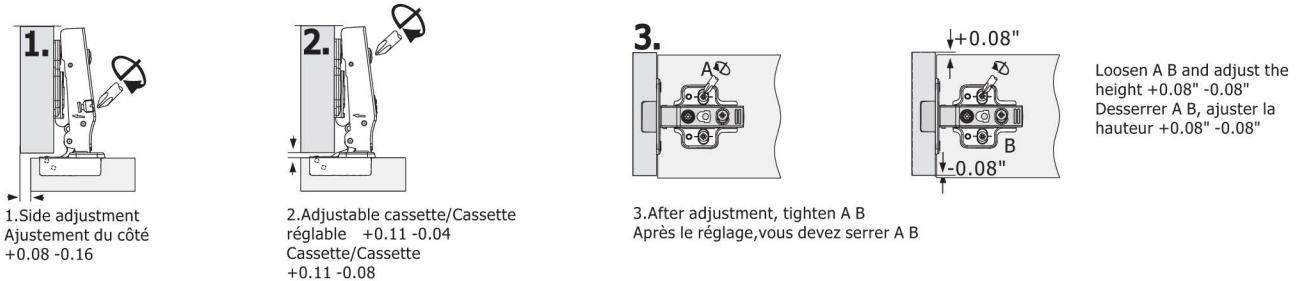

**Installation Instruction/Instructions d'installation**

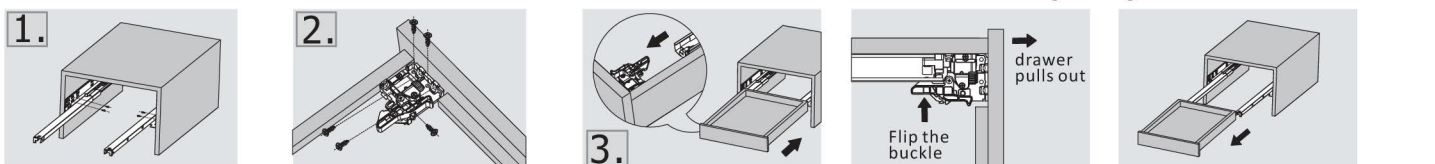

Flip the buckle of the front connector, then pull the drawer out to complete the disassembly. Retournez la boucle du connecteur avant, puis tirez sortir le tiroir pour terminer le démontage.

•Please check your product packaging to make sure the included accessories etc.  
 Veuillez vérifier l'emballage de votre produit pour vous assurer que les accessoires inclus

## Diagram Specifications

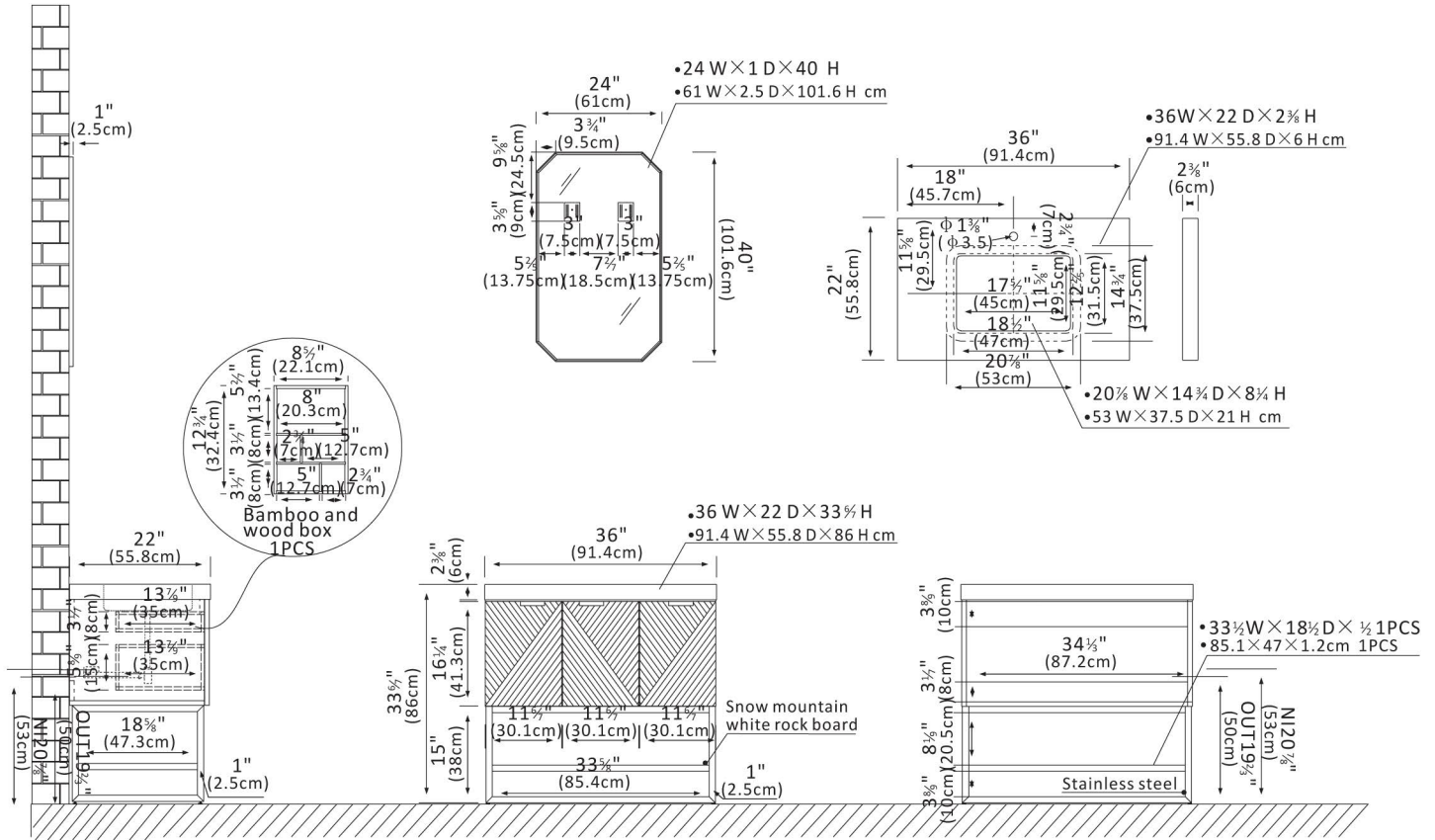

## Vanity Care Guide

### Vanity Care

- Avoid direct contact of sharp objects as they can cause exterior damage.
- Do not expose directly to the sun as it can cause aging and cosmetic damage.
- Avoid placing hot objects onto the vanity surface.

### Countertop Care

- Kindly note that all our tops are sealed before shipping but may stain, scratch, or chip because they are porous by nature.
- Do not place hot items directly on the countertop as it can damage it.
- To prevent ring marks or staining, dry immediately.
- Place table mats beneath objects that can potentially scratch the surface.
- Use a clean, soft fabric to dust the vanity.
- Occasionally wash with a cloth dampened in warm water. If needed, apply a small amount of mild dishwashing liquid or stone soap to clean. Dry with a soft cloth.
- Refrain from using chemical cleaners, sprays, abrasive cleaners, or products that contain lemon, vinegar, or other acids.
- We advise to reseal top annually or when necessary.

### Cleaning and maintenance

- Avoid using cleaning products that contain Bleach or Ammonia.
- Please use wood-friendly products on wooden base vanities.
- To adequately clean exterior surfaces, use natural cleaning solutions or soap

#### **⚠ WARNING**

This product can expose you to chemicals including Nickel compounds, which is known to the State of California to cause cancer. For more information visit [www. P65Warning. ca. gov](http://www.P65Warning.ca.gov)

#### **⚠ WARNING**

This product can expose you to Glass wool fibers (inhalable and biopersistent), which is known to the State of California to cause cancer. For more information, go to [www. P65Warnings. ca. gov](http://www.P65Warnings.ca.gov)

#### **⚠ WARNING**

Serious or fatal crushing can occur from furniture tip over . To prevent tip over this furniture must be used with the wall attachment device(s) provided.

Screw(s) and plug(s) for the wall are not included. Use screw(s) and plug(s) suitable for your walls. If you are uncertain, seek professional Advice. Read and follow each step of the instruction carefully.