

**\*INSTALLING VANITY WITH TWO PEOPLE IS HIGHLY RECOMMENDED\***  
**\*L'INSTALLATION DE LA VANITÉ AVEC DEUX PERSONNES EST FORTEMENT RECOMMANDÉE\***

Box Contents/Contenu de la boîte

- Ceramic Basin/Countertop  
Bassin/comptoir en céramique
- Vanity Base/Cabinet  
Base de vanité/Cabinet
- Vanity Mirror/ Mirror  
Miroir de courtoisie/Miroir

Main Body Parts/La partie principale du corps

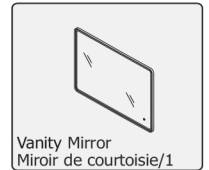
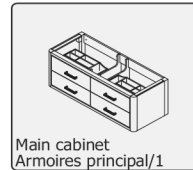
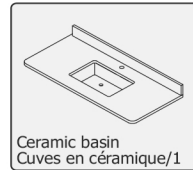

Main Cabinet Installation Instructions/  
Instructions d'installation de l'armoire principale

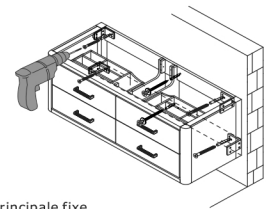
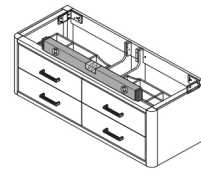

1. Secure the main cabinet / Armoire principale fixe



After still for 24 hours

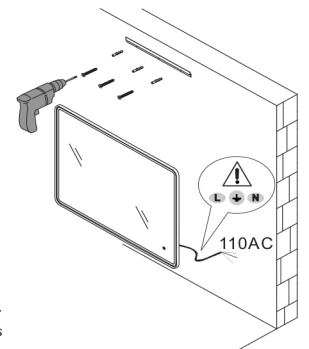
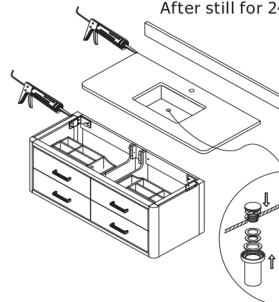

\*Does not include faucet, drain assembly, or P-trap/Les robinets, les ensembles de drains ou les pièges à eau Le P - trap sont pas inclus.

2. Paste the countertop/Collez le comptoir

3. Hang the mirror/Accrocher le miroir

Installation Tips/Conseils d'installation

- Add silicone to attach frame/  
Ajouter du silicone pour fixer le cadre
- Secure the countertop to the main cabinet/  
Fixez le comptoir à l'armoire principale

Recommended tools/Outils recommandés

- Tape measure/  
mètre à ruban
- Pencil/  
Crayon
- Screwdriver (Manual/Mechanical)/  
Tournevis (manuel/mécanique)
- Level/Niveau
- Calking & Calking Gun/  
Pistolet à calfeutrer et à calfeutrer

Installation tool/Outil d'installation

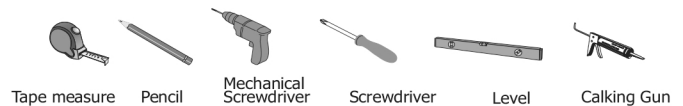

Installation Instruction/Instructions d'installation

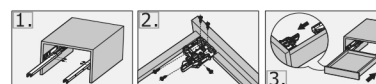

Removal of slide rail with front connector  
Démontage de la glissière avec connecteur frontal

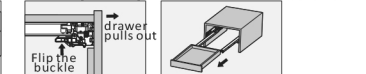

Flip the buckle of the front connector, then pull the drawer out to complete the disassembly  
Retournez la boucle du connecteur avant, puis tirez sortir le tiroir pour terminer le démontage

• Please check your product packaging to make sure the included accessories etc.

## Diagram Specifications

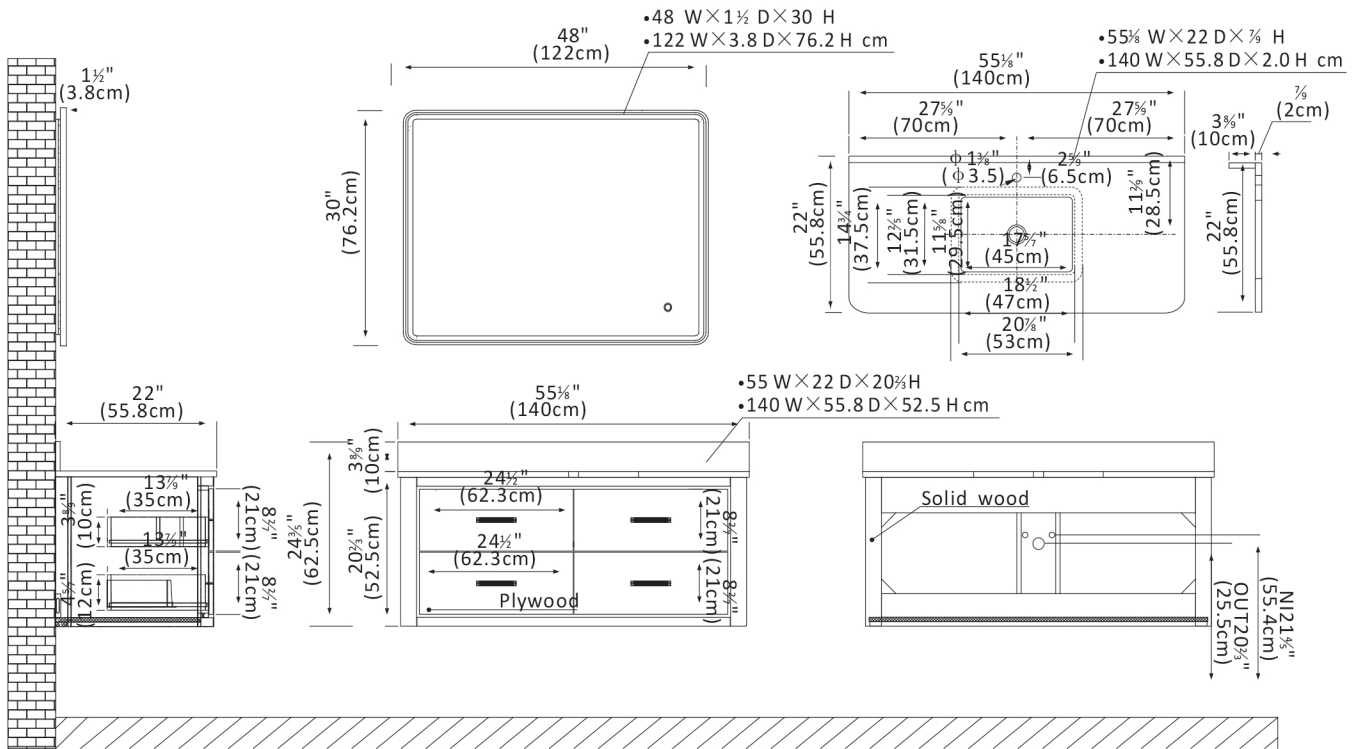

## Vanity Care Guide

### Vanity Care

- Avoid direct contact of sharp objects as they can cause exterior damage.
- Do not expose directly to the sun as it can cause aging and cosmetic damage.
- Avoid placing hot objects onto the vanity surface.

### Countertop Care

- Kindly note that all our tops are sealed before shipping but may stain, scratch, or chip because they are porous by nature.
- Do not place hot items directly on the countertop as it can damage it.
- To prevent ring marks or staining, dry immediately.
- Place table mats beneath objects that can potentially scratch the surface.
- Use a clean, soft fabric to dust the vanity.
- Occasionally wash with a cloth dampened in warm water. If needed, apply a small amount of mild dishwashing liquid or stone soap to clean. Dry with a soft cloth.
- Refrain from using chemical cleaners, sprays, abrasive cleaners, or products that contain lemon, vinegar, or other acids.
- We advise to reseal top annually or when necessary.

### Cleaning and maintenance

- Avoid using cleaning products that contain Bleach or Ammonia.
- Please use wood-friendly products on wooden base vanities.
- To adequately clean exterior surfaces, use natural cleaning solutions or soap

### WARNING

This product can expose you to chemicals including Nickel compounds, which is known to the State of California to cause cancer. For more information visit [www. P65Warning. ca. gov](http://www.P65Warning.ca.gov)

### WARNING

This product can expose you to Glass wool fibers (inhalable and biopersistent), which is known to the State of California to cause cancer. For more information, go to [www. P65Warnings. ca. gov](http://www.P65Warnings.ca.gov)

### WARNING

Serious or fatal crushing can occur from furniture tip over . To prevent tip over this furniture must be used with the wall attachment device(s) provided.

Screw(s) and plug(s) for the wall are not included. Use screw(s) and plug(s) suitable for your walls. If you are uncertain, seek professional Advice. Read and follow each step of the instruction carefully.