

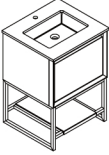

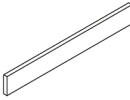

Model: Alto - 24"

Installation Instructions

Notes: We recommend that you rough-in the drain and water lines after receiving the unit.
The vanity should be installed by a professional plumber.
Drainer pipe and trap are not included.

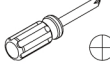
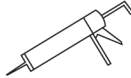
	A (cabinet)	B (backsplash)	C (Screw)	D (Expansion plastic)
Part List	 x1	 x1	 x2	 x2
Tools required	 screwdriver(phillips)	 silicone	 level	 tape measure

Step 1

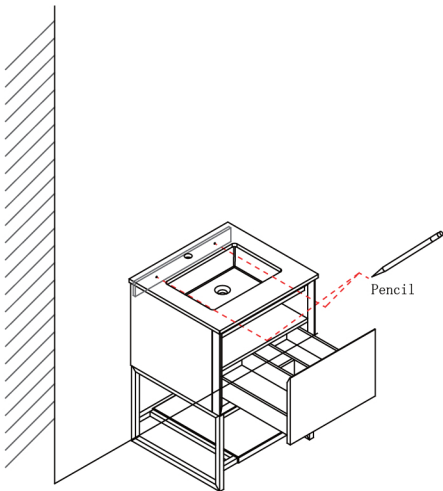

Step 2

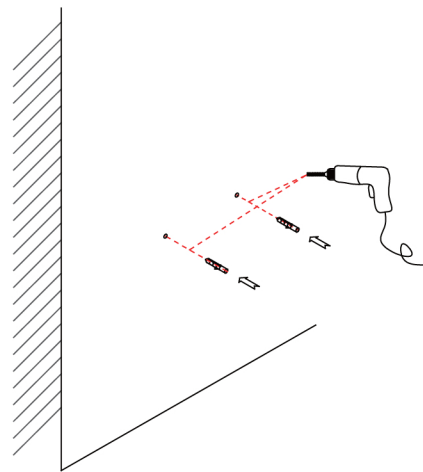

Step 3

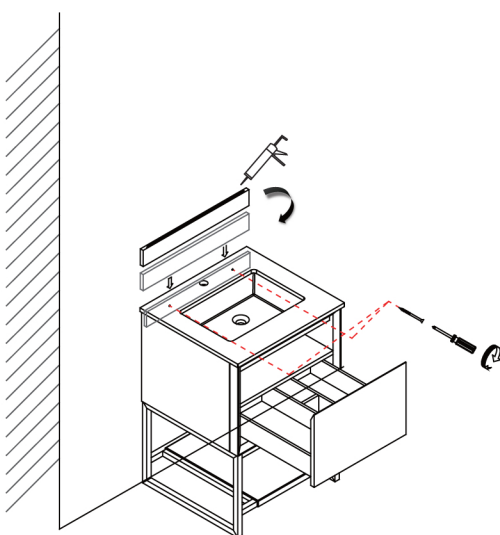

Step 4

