







# Model: Wilson - 24"

## Installation Instructions

**Notes:** We recommend that you rough-in the drain and water lines after receiving the unit.  
The vanity should be installed by a professional plumber.  
Drainer pipe and trap are not included.

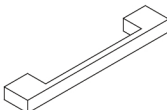
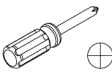
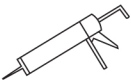
	A (cabinet)	B (backsplash)	C (screw)	D (handle)	D (handle)
Part List	 x1	 x1	 x6	 x2	 x1
Tools required	 screwdriver(phillips)	 silicone	 level	 tape measure	

### Step 1

**CAUTION**  
Handle the backsplash with extreme care!  
Stone backsplash are very fragile.  
Always handle gently and place them flat  
on a soft surface.

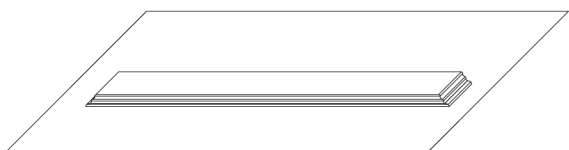

### Step 2

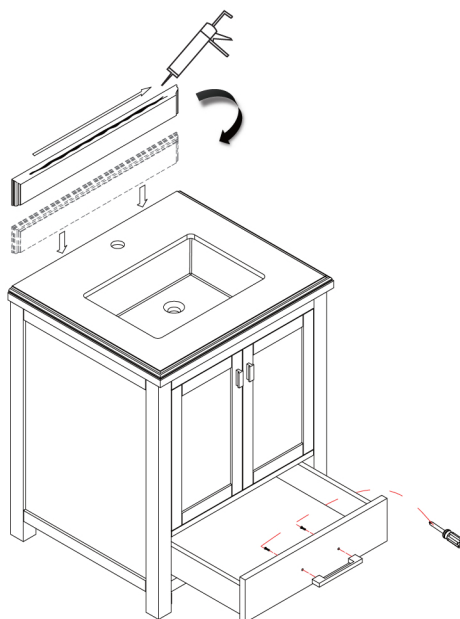

### Step 3

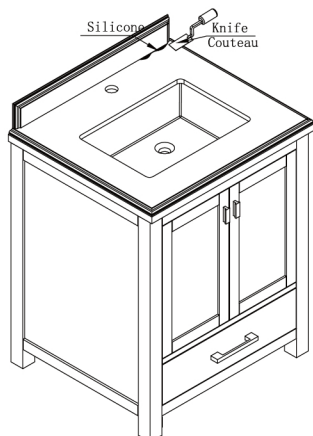

### Step 4

