

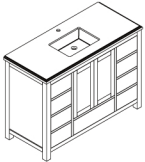





Model: Wilson - 48"

Installation Instructions

Notes: We recommend that you rough-in the drain and water lines after receiving the unit.
The vanity should be installed by a professional plumber.
Drainer pipe and trap are not included.

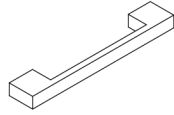
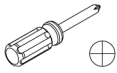
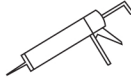
	A (cabinet)	B (backsplash)	C (screw)	D (handle)	D (handle)
Part List	 x1	 x1	 x14	 x2	 x9
Tools required	 screwdriver(phillips)	 silicone	 level	 tape measure	

Step 1

CAUTION
Handle the backsplash with extreme care!
Stone backsplash are very fragile.
Always handle gently and place them flat
on a soft surface.

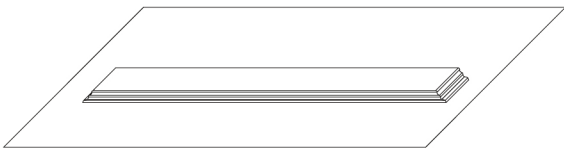

Step 2

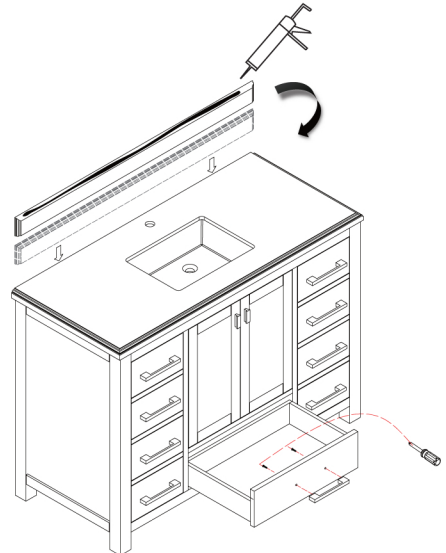

Step 3

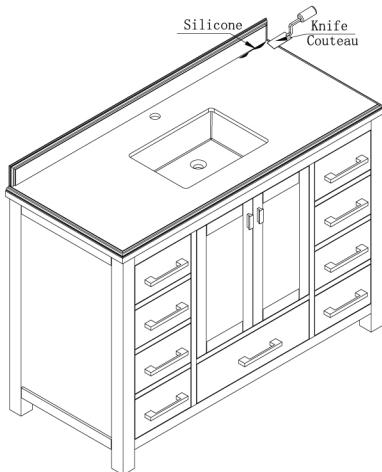

Step 4

