

Barn Door Hardware Installation

For Use with 96" Bent Strap LG Wheel Hanger Kits

Parts Included:

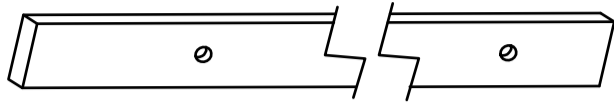

Rail 96" Long (x1)

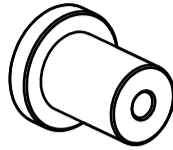

Rail Wall Spacer (x6)

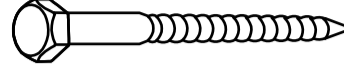

Lag Bolt M8 x 90MM (x6)



M8 Washer (x6)

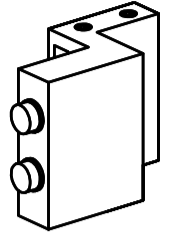

Door Stop(x2)

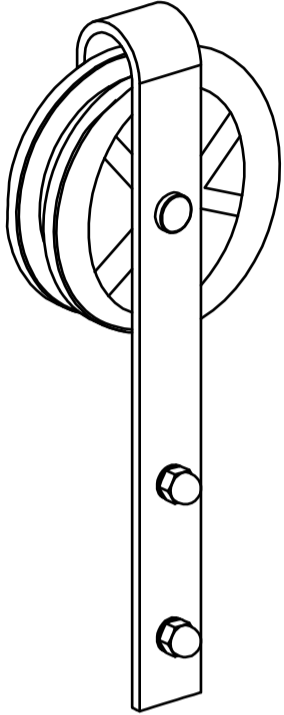

Door Hanger(x2)

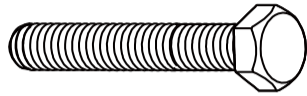

M10 x55MM Bolt For 1-3/8" Doors (x4)

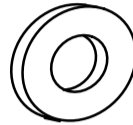

M10 Washer(x8)

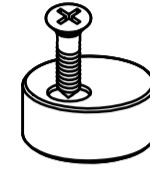

Anti Jump Disk(x2)



Allen Wrench M2 (x1)

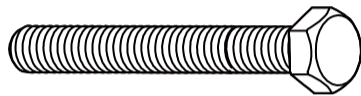

M10 x60MM Bolt For 1-3/4" Doors (x4)

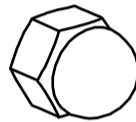

M10 Cap Nut (x4)

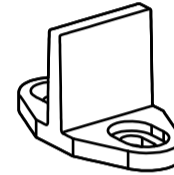

Mortise Door Guide(x1)
ST4.2x25mm(x2)
Ø6 Anchors (x2)

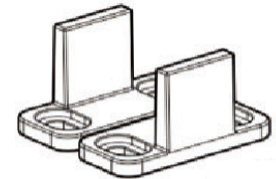

Non-Mortise Door Guide(x2)
ST4.2x25mm(x4)
Ø6 Anchors (x4)

The tools below are NOT included in the package and are needed for installation.

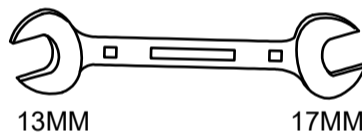
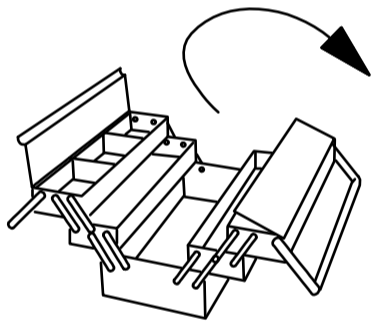

13MM

17MM

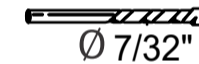
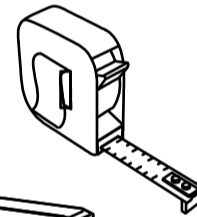
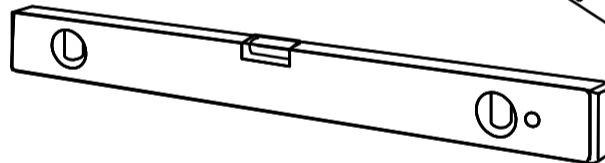

Ø 7/32"



Ø 3/8"



Ø 1/4"

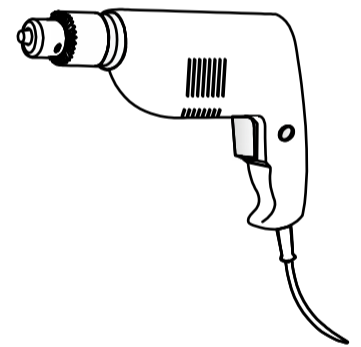

1 Rail Mounting Instructions, Locating the Mounting Position

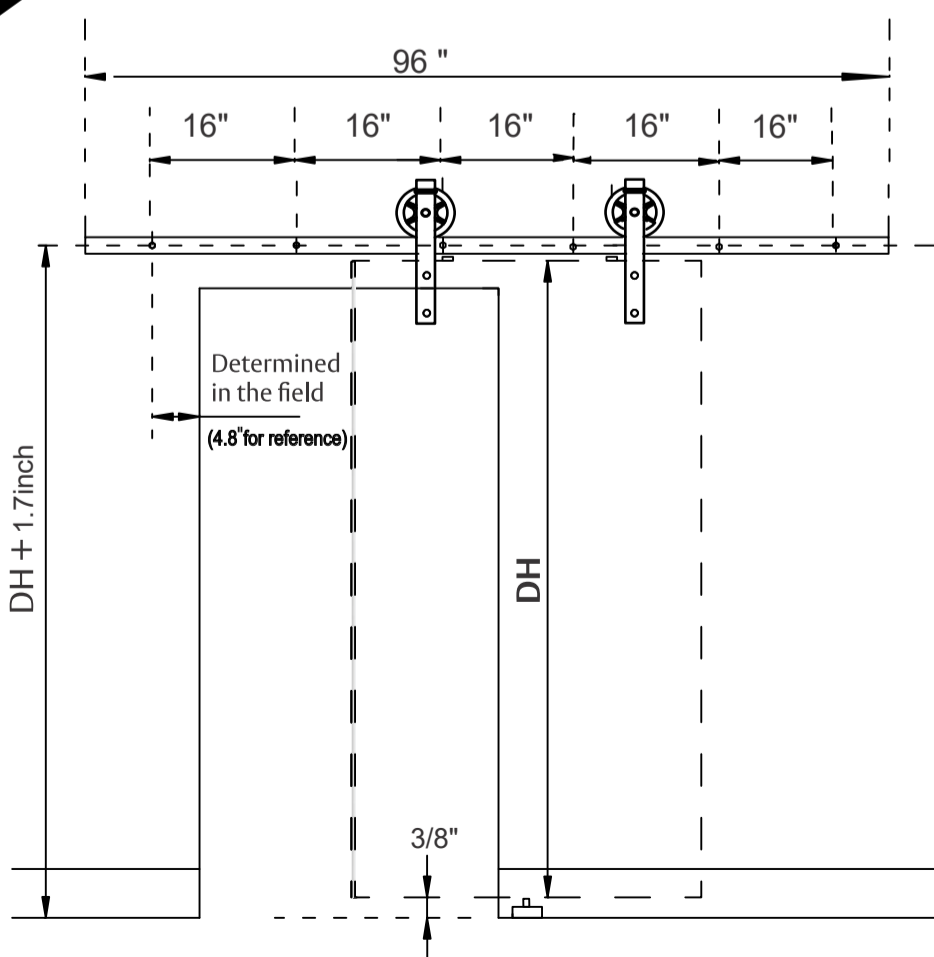

DH = Door Height

Recommend that you layout your door and hardware on the floor first to determine spacing.

Measure twice Mount once

Rail must be level to keep door from moving by itself!

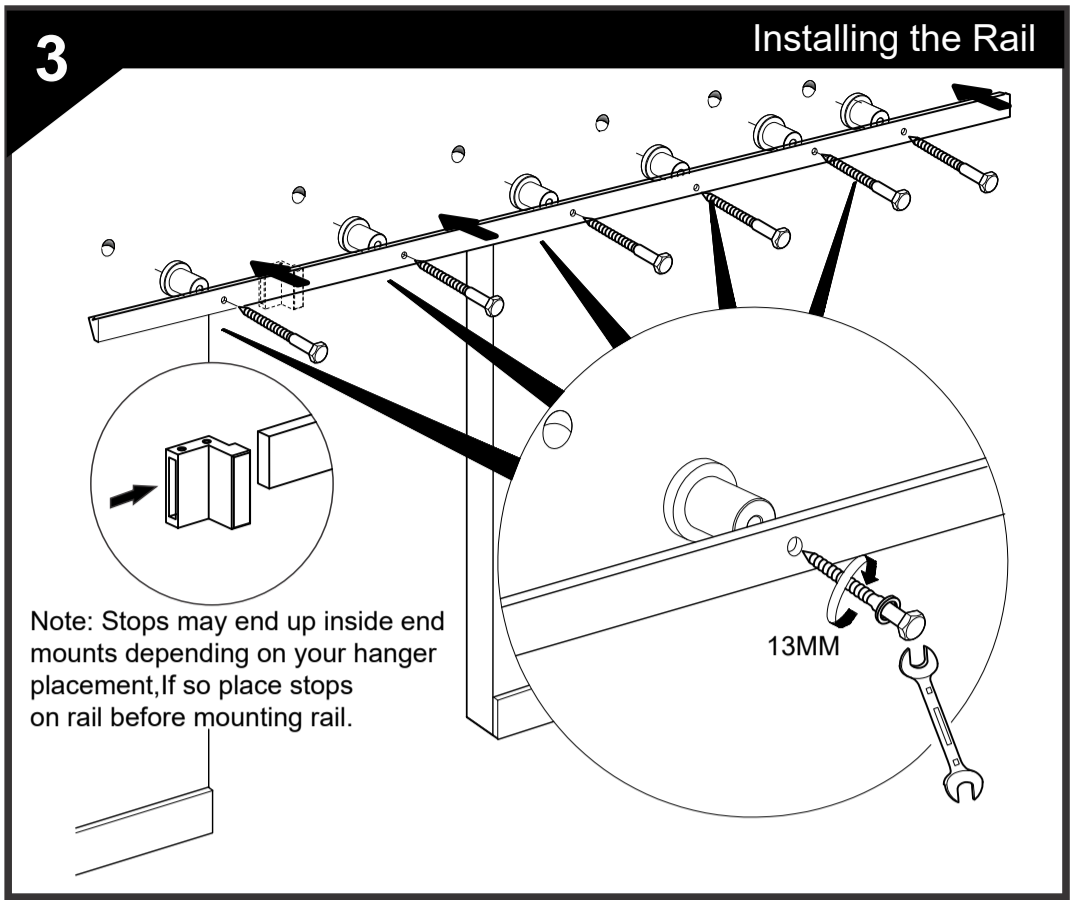
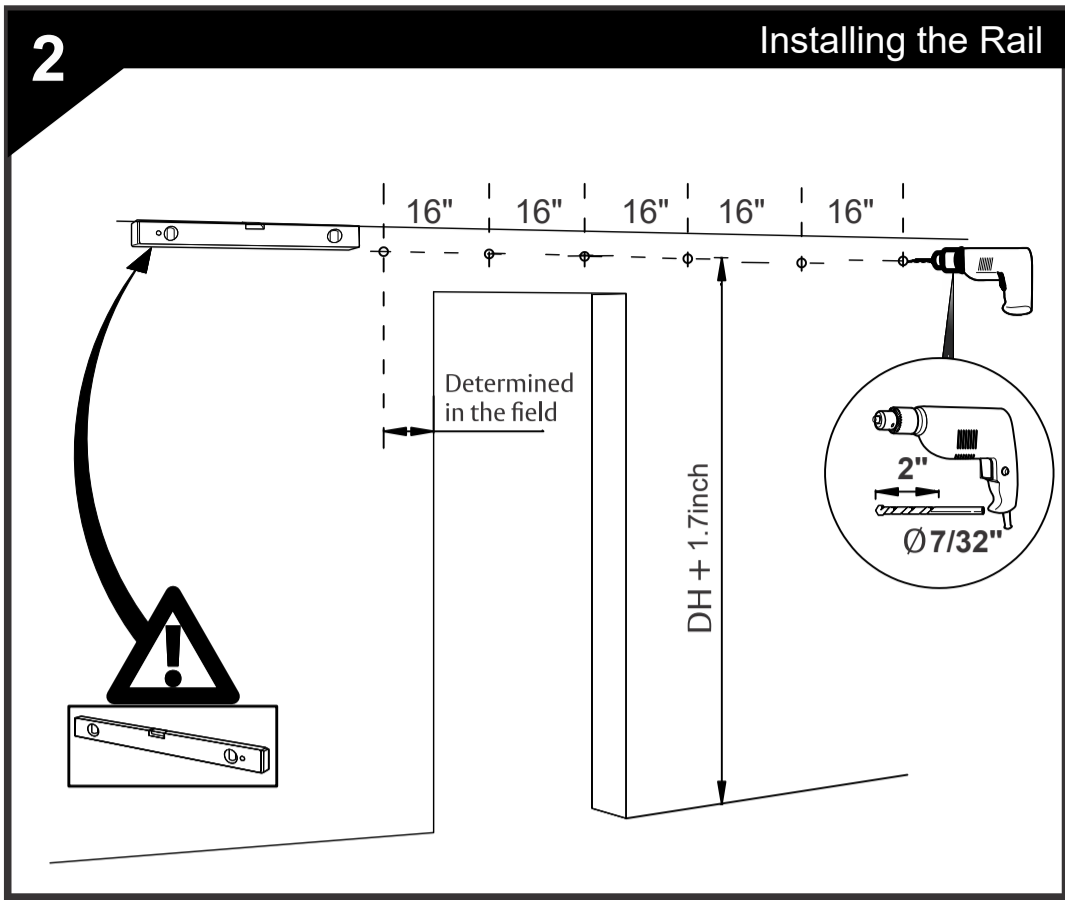

All Rail Mounts must be screwed into a solid Wood Header

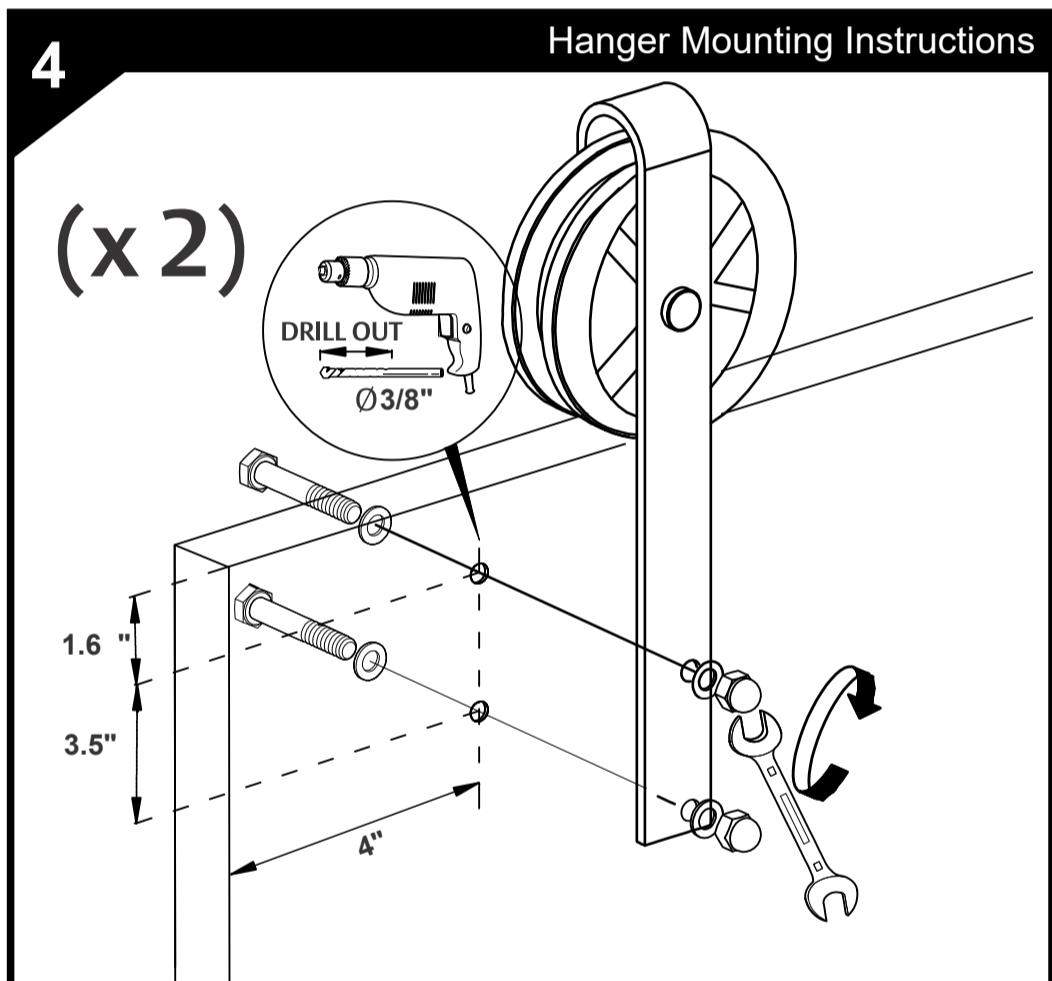

Hanger position from the edge can vary based on your door design. Position Shown is for a flat Surface Door you may have to Adjust to center Hanger onto the vertical styles of your door

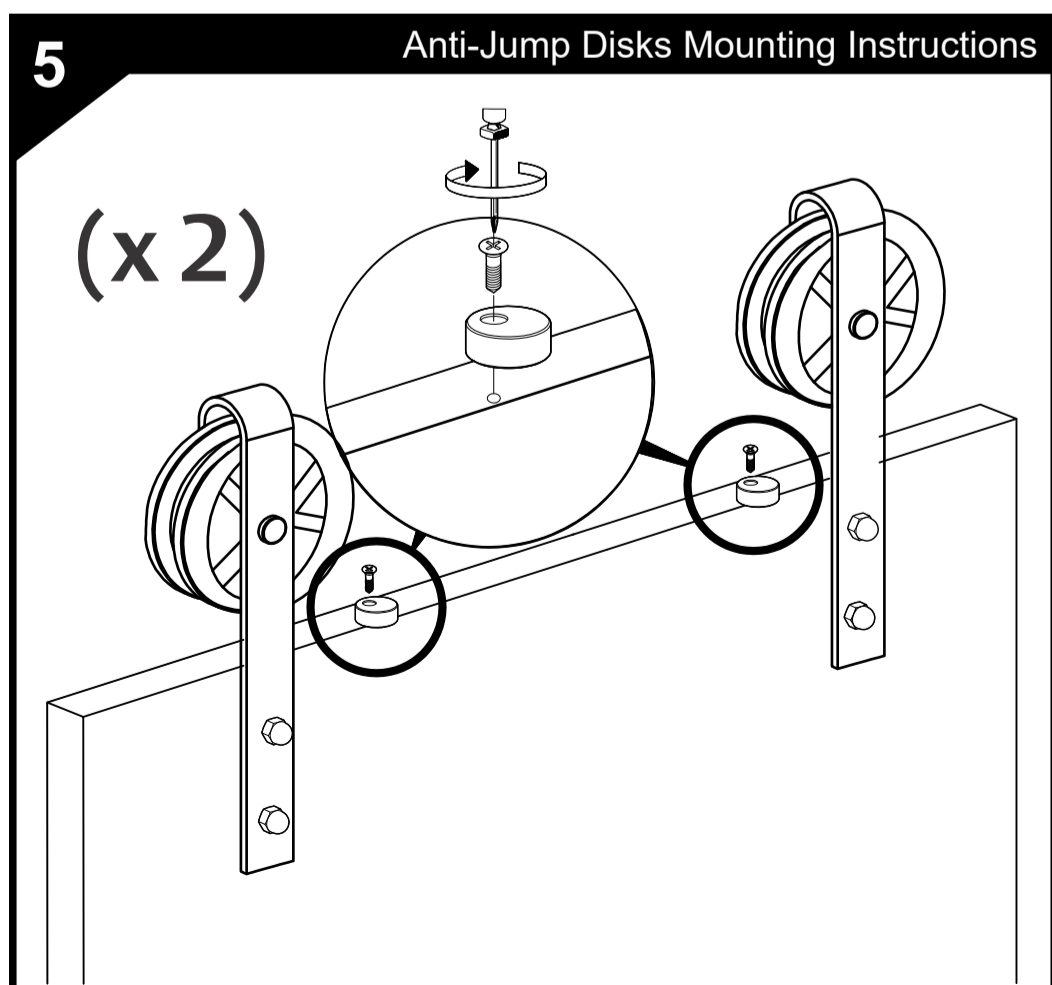
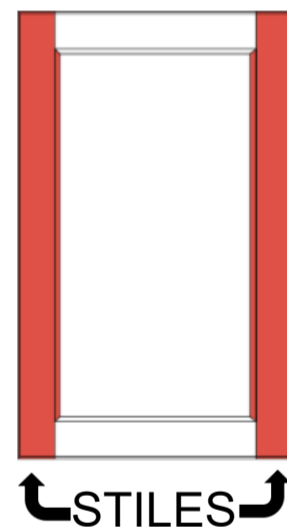

Anti Jump Disks keep your door from accidentally coming off the Rail. They are installed offset with the Screw outside the rail in case you need to remove the door later. Once your installation is complete rotate the Disks under the rail and tighten down.

6 Bottom Guide Mounting Instructions

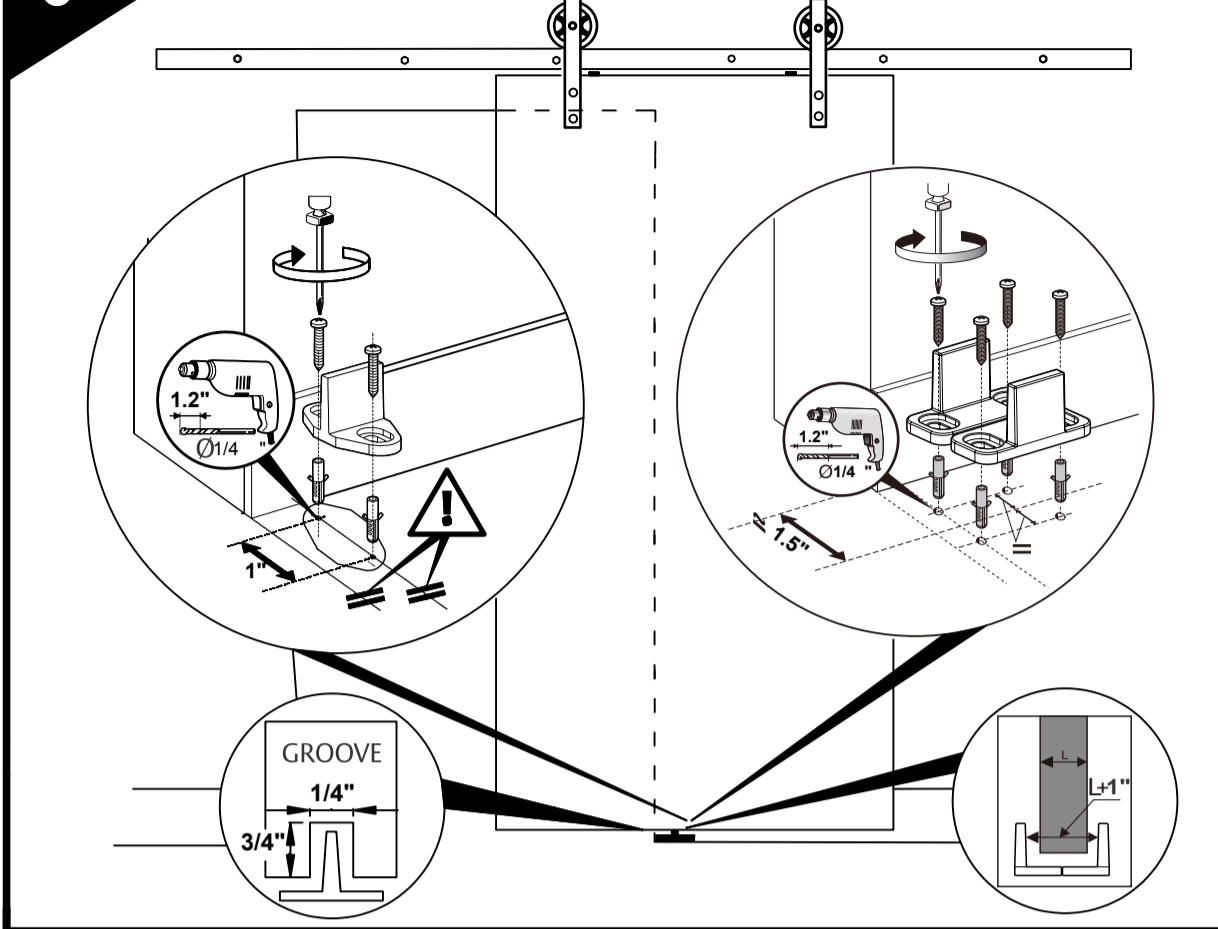

The Guide Stabilizes the door by keeping the bottom from Swinging. Kit includes both a Mortise (Groove in the bottom of the door) and a Non-Mortise option.

This step will require hanging and removing the door to measure and install the Guides

7 Final Door Hanging - Anti-Jump Disk Lockdown

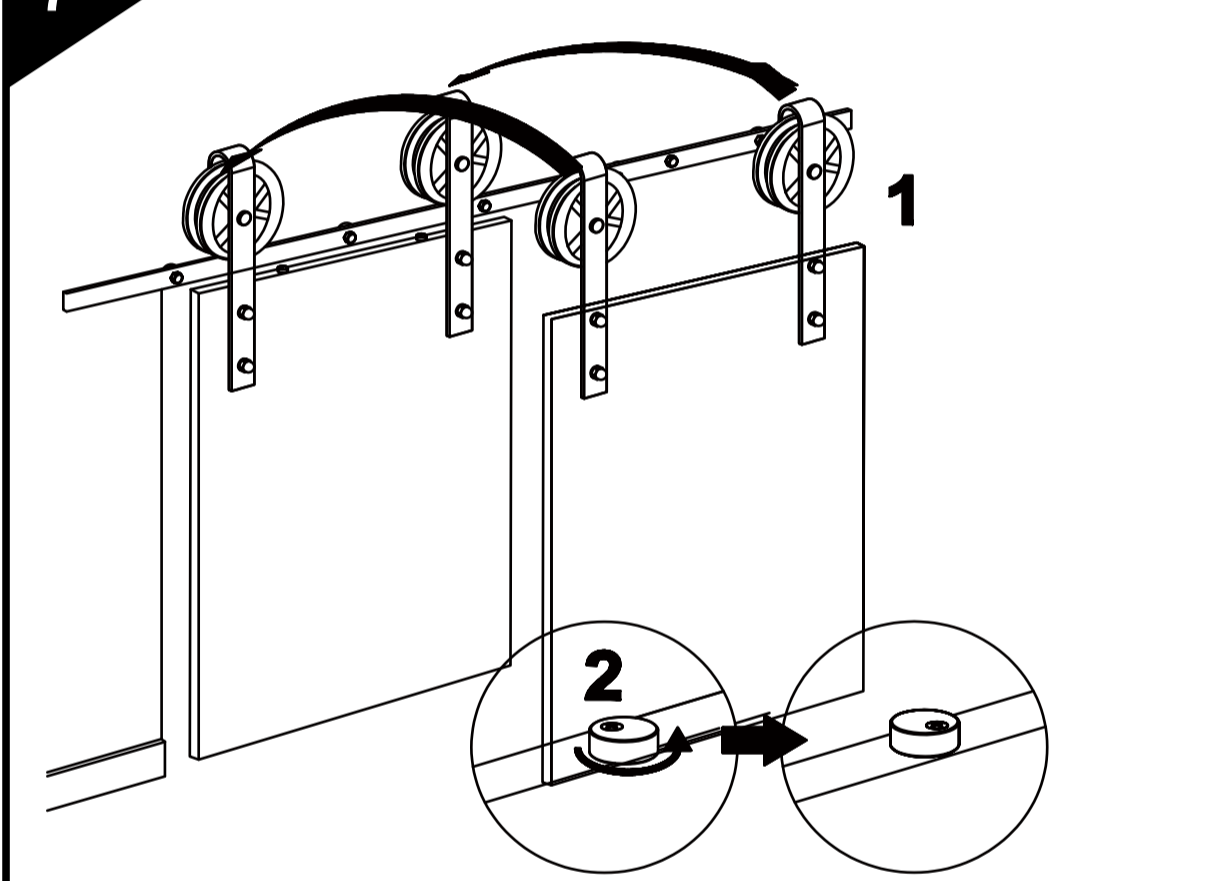

Hang the door and slide it into the Floor Guide then Rotate the Anti Jump Disks under the rail and tighten down the screws to lock them in place

8 Door Stop Positioning Instructions

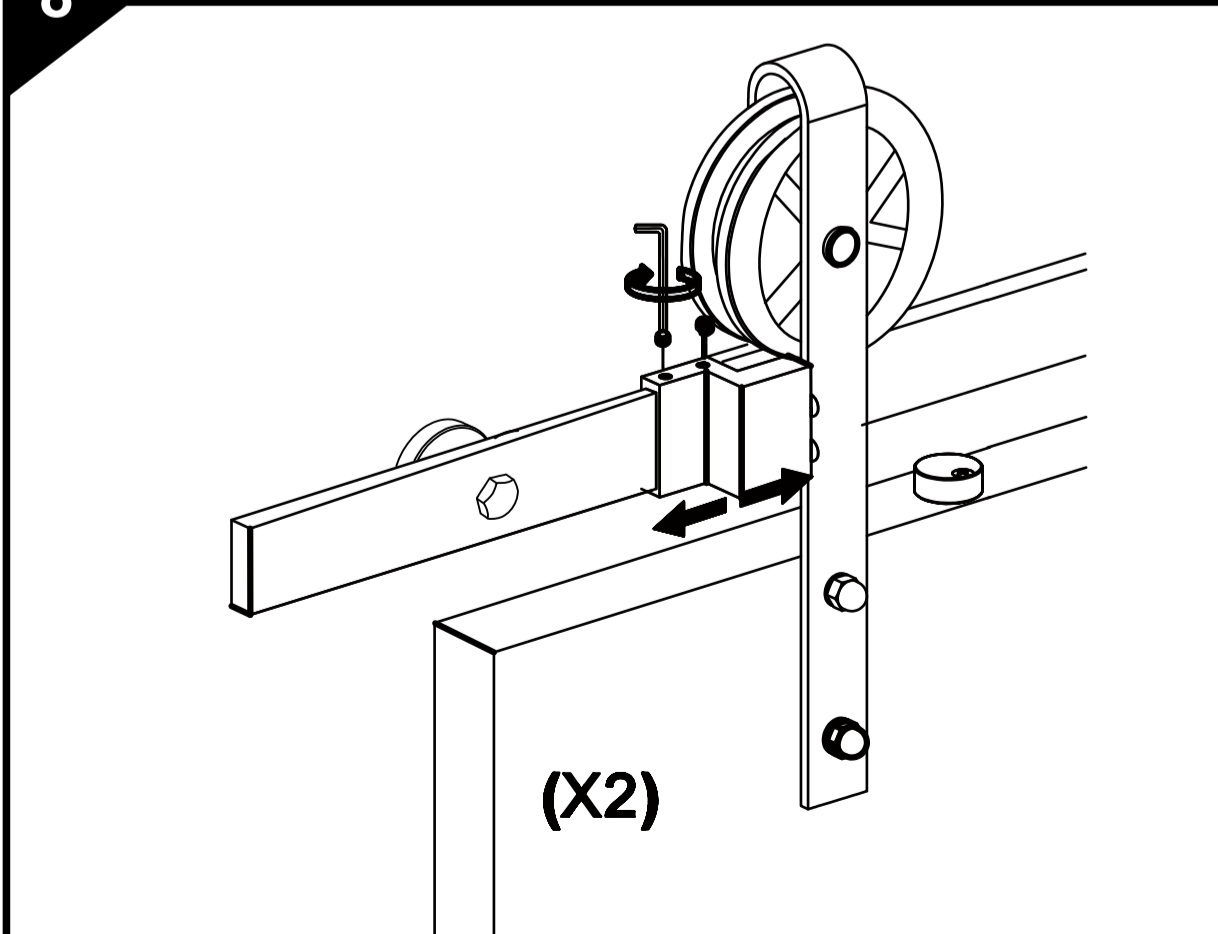

Adjust your Door Stops to your desired position and lock down your Door Stops with the Allen Wrench Provided

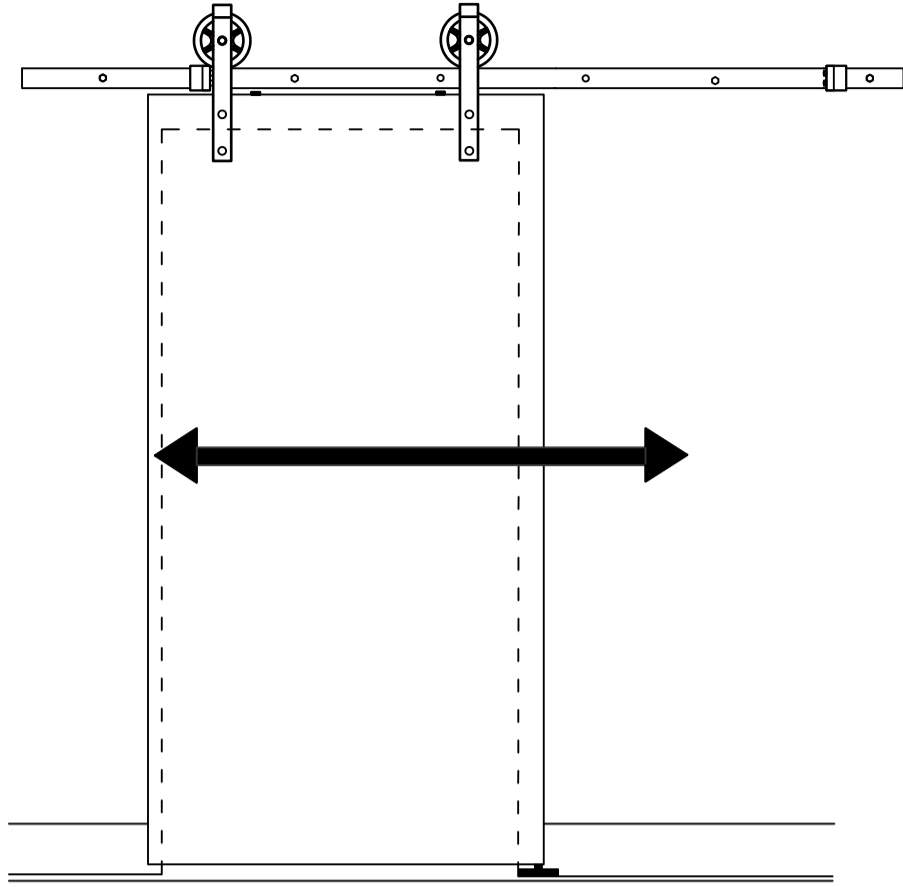

Door should Slide smoothly in both Directions

Optional Accessories

Soft Close Adapter Kit

Each kit Contains a left and right Soft Closer that mounts behind the Rail and keeps children from slamming doors.



Handles Interior and Exterior

Handles make Opening and Closing the door easier



Privacy Latch

Especially important on bathroom doors



Steel Door Guides

Low Profile and Industrial look wall mount



Expansion Parts

24" Rail Extensions, By-Bass brackets, Rail Joiners , Masonry Rail Mounts

