

TATIANNNA

by MISENO

MBCTATI-B
MBCTATI-G
MBCTATI-W

MEDICINE CABINET

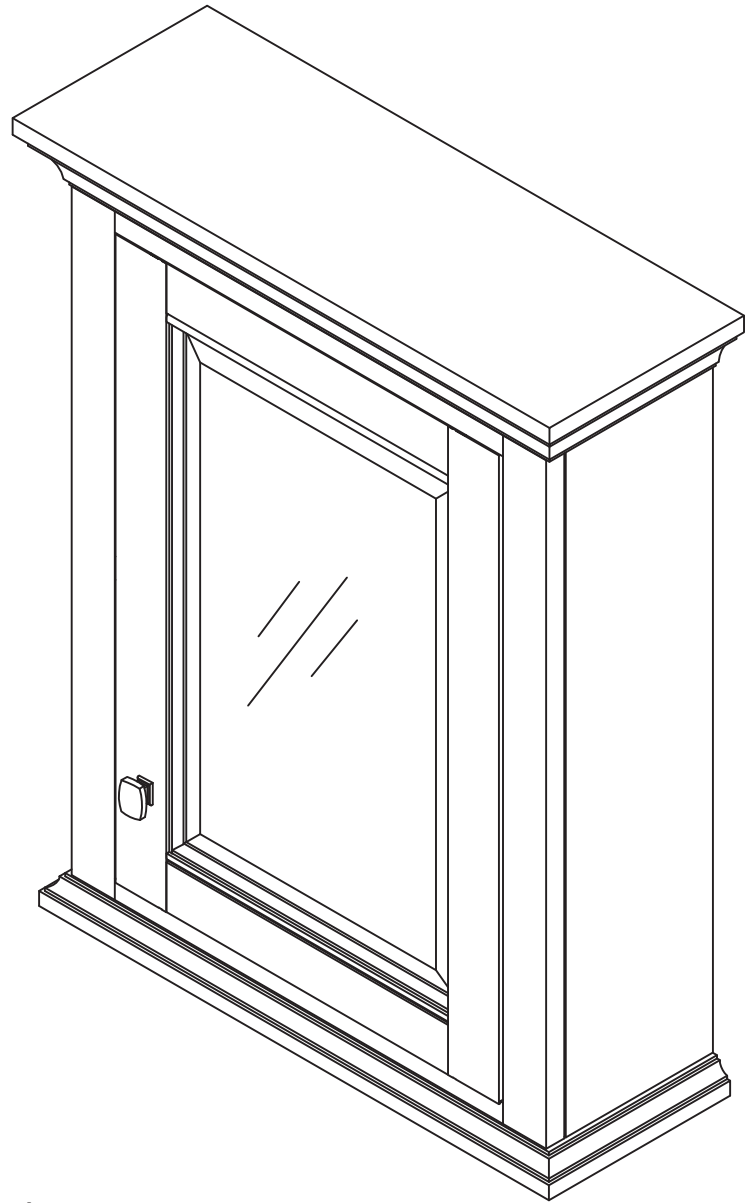





Toll Free Customer Assistance

Monday-Friday, 7:00a.m. To 5:00p.m., PST

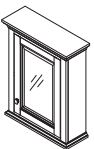
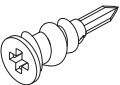
1-855-480-2915 for U.S. and Canadian Customers

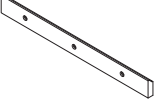
PARTS LIST

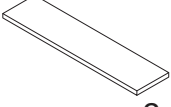
A  x 1	B  x 3	C  x 3	D  x 1	E  x 8	F  x 2
--	--	--	--	--	--

TOOLS REQUIRED

NOT INCLUDED

