

# MISENO

## USER GUIDE

### LED LIGHTED MIRROR

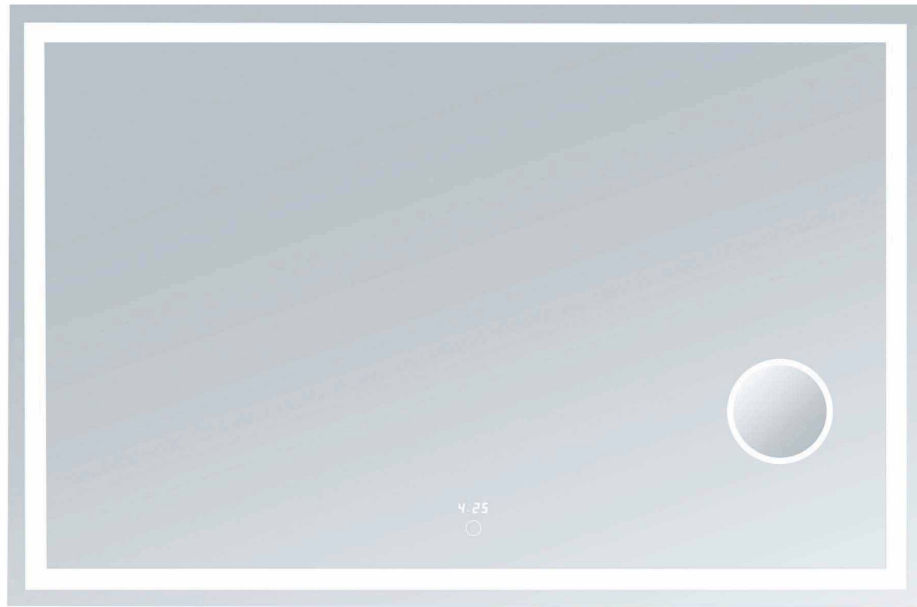

MODEL:  
MM4835SLED

## IMPORTANT SAFETY INFORMATION

Please read through this installation instruction so you will know how to install and operate your model properly. Keep this document in a safe place for future reference after use.

### **WARNING**

This product must be installed in accordance with the installation instruction by qualified technician. Failure to follow instruction could result in death or serious bodily injury.

### **CAUTION**

This product must be serviced by qualified personnel. ALWAYS unplug the power cord or turn off the circuit breaker before service.

## PACKAGE CONTENTS

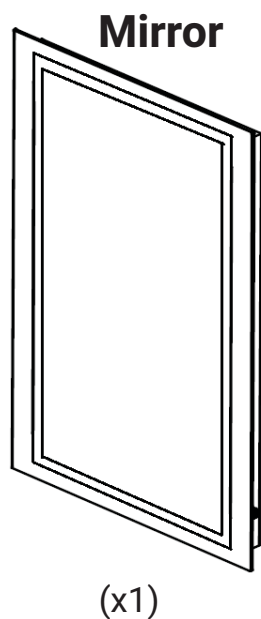

### **Mounting Bracket**

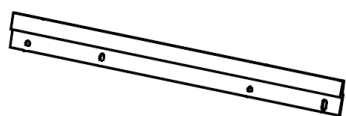

(MM4835SLED x 2)

### **Screw**



(MM4835SLED x 4)

### **Drywall Anchor**



(MM4835SLED x 4)

# INSTALLATION

1

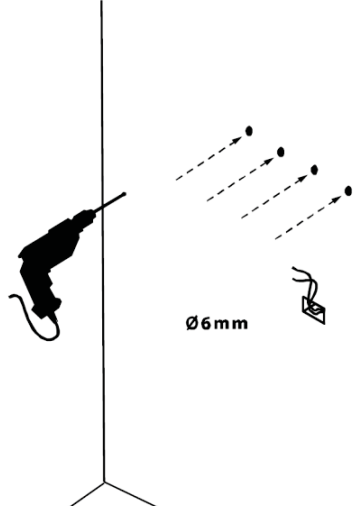

Ø6mm

For drywall installation, mark the hole locations and drill  $\varnothing$  6mm holes for the drywall anchors.

2

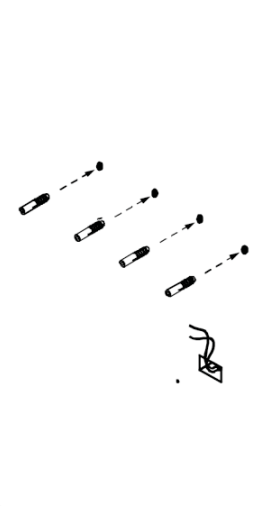

Insert provided drywall anchors.

3

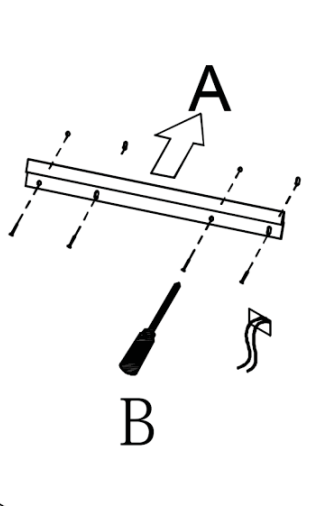

Install the mounting bracket.

4

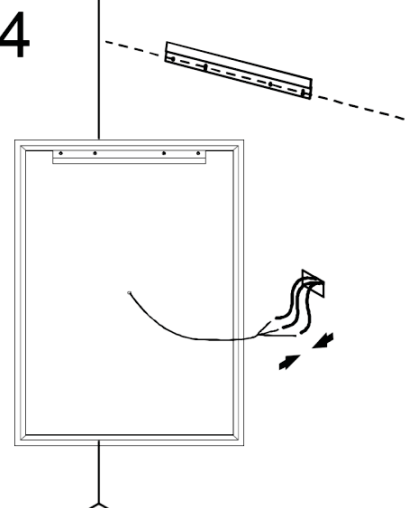

Connect to 110V power supply.

5

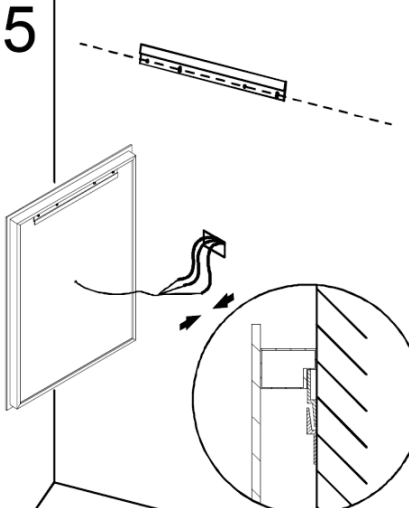

Hang the mirror to the wall and make sure the bracket in the back of the mirror lineup with the mounting bracket properly.

6

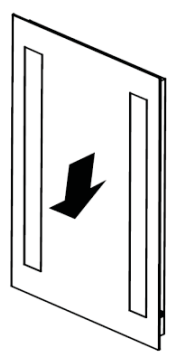

Press the mirror down slightly and make sure the brackets fit properly.



- Using the wall studs to hang the mirror is highly recommended.

# INSTALLATION DIMENSIONS

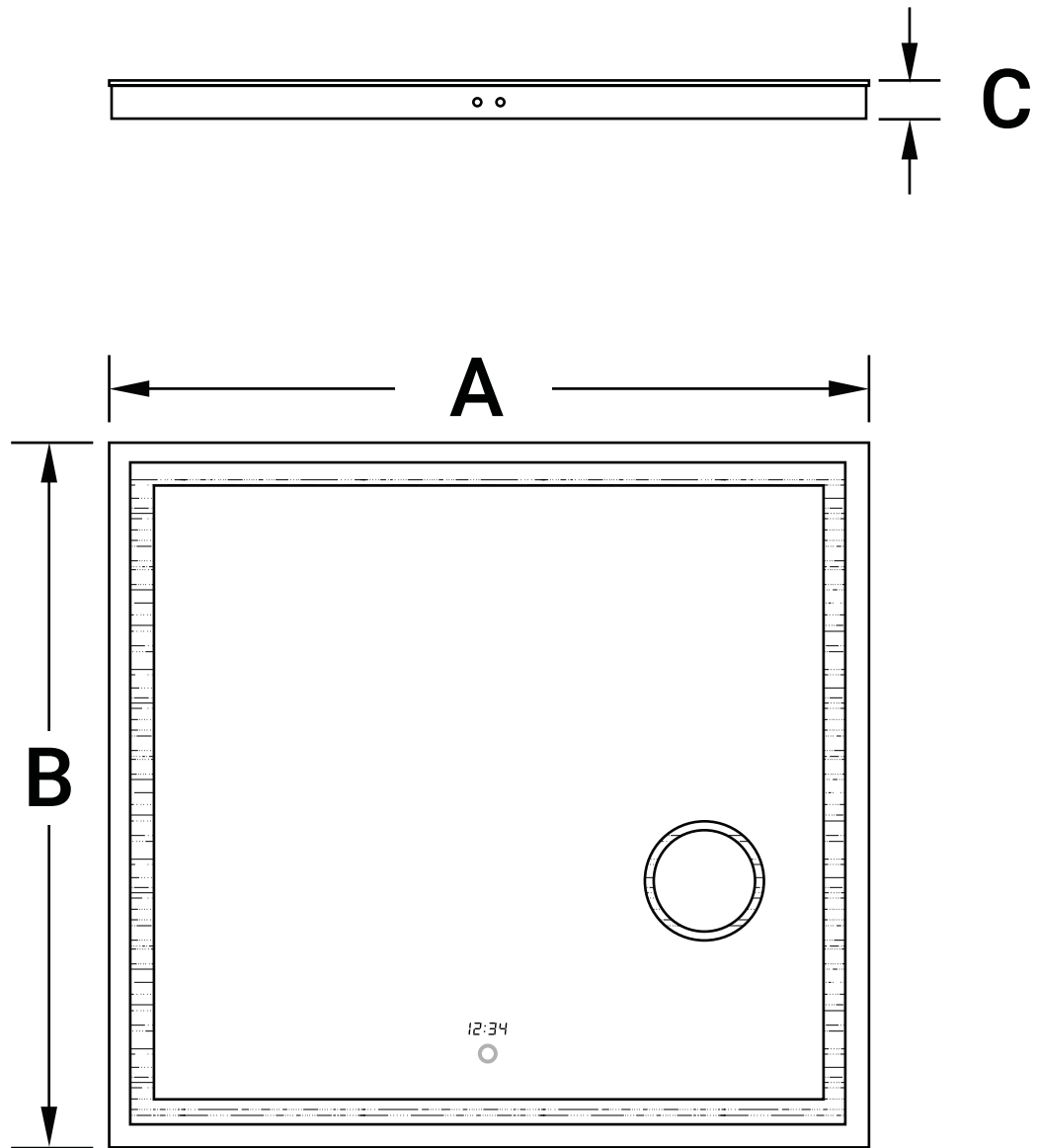

Model#	A	B	C
MM4835SLED	48	35	1 5/8

# BASIC OPERATION

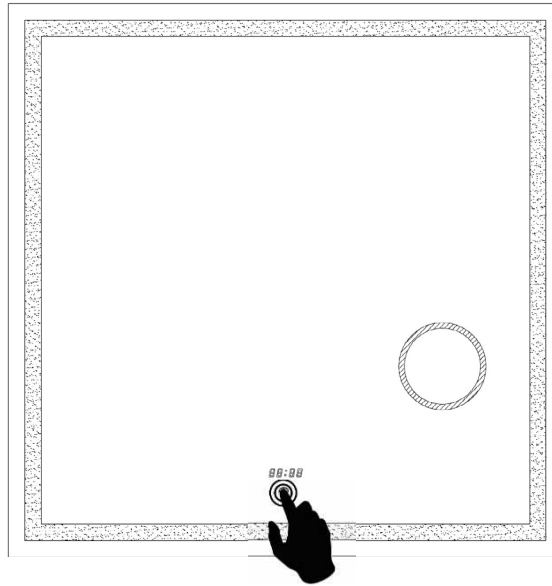

## 1. Touch switch

- Press the switch once to turn on/off the LED lights.
- When the lights are on, press and hold the switch for about 3 seconds to change the color temperature.

## 2. Setting the clock

- To change the hour, press the button on the left.
- To change the minute press the button on the right.

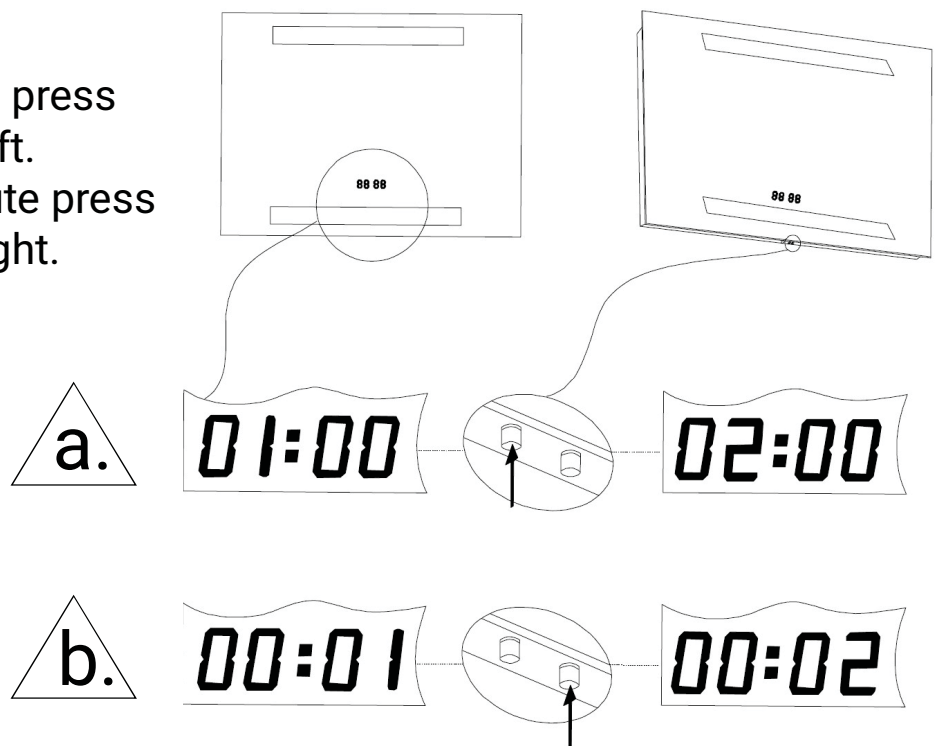

## **CARE AND MAINTENANCE**

Clean the mirror with a soft, damp cloth and dry thoroughly with a soft towel. Do NOT allow the edges of the mirror to get or remain wet over a period of time. Please do NOT use glass cleaner that contains ammonia or vinegar. Never spray any cleaner directly onto a mirror. Instead apply the cleaner to a soft cloth and then wipe the mirror. Make sure no commercial cleaner comes in contact with the edge or backing.

## **WARRANTY**

### **DEFECTIVE GOODS CONSUMER WARRANTY**

Miseno inspects all of its products prior to shipment. We offer a 5-year Limited warranty on our electric mirror products. Defective products should be returned to place of purchase for replacement. However, if this is not possible, we accept returns on defective product with our written authorization. Returns will be handled by product replacement. Defects or damage caused to the product by the consumer do not qualify for warranty replacement.

### **SHORTAGE OR DAMAGED PRODUCTS**

All shipments are carefully inspected and counted before leaving our distribution centers. Please inspect carefully on receipt of merchandise, noting any discrepancy or damage on the carrier's freight bill at that time, and file a claim with the carrier within 10 days from receipt of order. Then contact our office. Deductions from invoices for shortages or damage claims will not be allowed.

### **RETURN NEW GOODS**

All claims for returns or adjustments must have prior approval and return authorization (RMA) number. Only original, sealed product in salable condition are eligible for a general return. Credit for authorized general returns will be issued at the net price paid for the product and may be subject to a 15% restocking/handling fee. Merchandise is to be returned via prepaid freight. All unauthorized returns will be refused or subject to a 25% restocking/handling fee.

# REPLACEMENT PARTS

Part	Description
1	Mirror
2	Magnifier
3	Touch Switch
4	Clock Dials
5	Aluminum Frame
6	Clock Unit
7	Connection Box
8	Clock Driver
9	LED Driver
10	Touch Switch Box
11	LED Strip Support
12	LED Strip
13	Galvanized Plate
14	Cable Gland
15	Mounting Bracket

