

# MISENO

## USER GUIDE

### LED LIGHTED MIRROR



Models:  
MM4040RDLED | MM5636RDLED

## IMPORTANT SAFETY INFORMATION

Please read through this installation instruction so you will know how to install and operate your model properly. Keep this document in a safe place for future reference after use.

### **WARNING**

This product must be installed in accordance with the installation instruction by qualified technician. Failure to follow instruction could result in death or serious bodily injury.

### **CAUTION**

This product must be serviced by qualified personnel. ALWAYS unplug the power cord or turn off the circuit breaker before service.

## PACKAGE CONTENTS

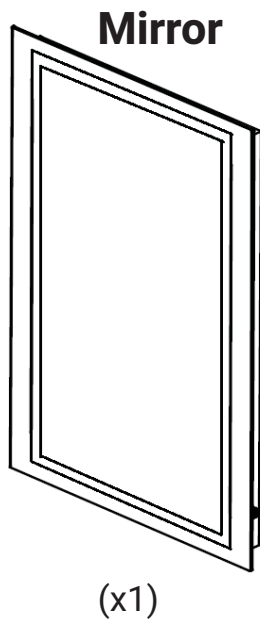

**Mounting Bracket**

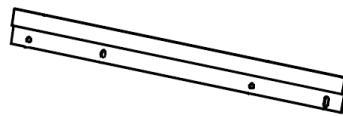

(MM4040RDLED x2)  
(MM5636RDLED x2)

**Screw**

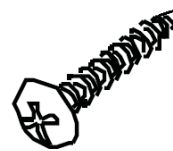

(x4)

**Drywall Anchor**



(x4)

# INSTALLATION

1

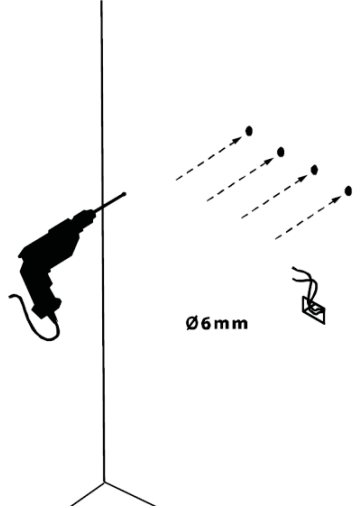

Ø6 mm

For drywall installation, mark the hole locations and drill  $\varnothing$  6mm holes for the drywall anchors.

2

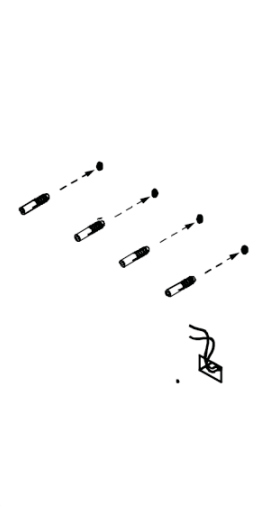

Insert provided drywall anchors.

3

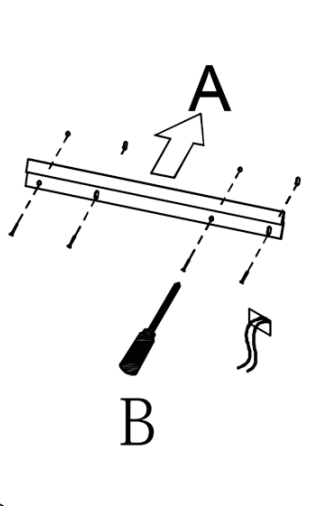

Install the mounting bracket.

4

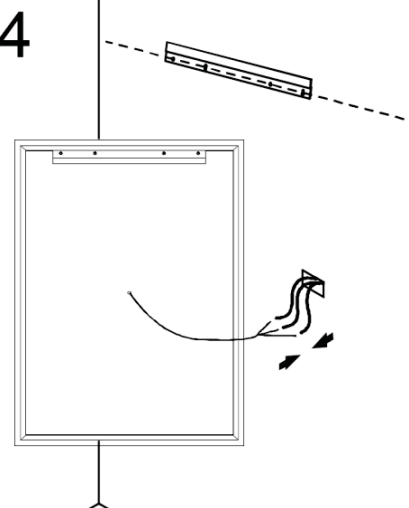

Connect to 110V power supply.

5

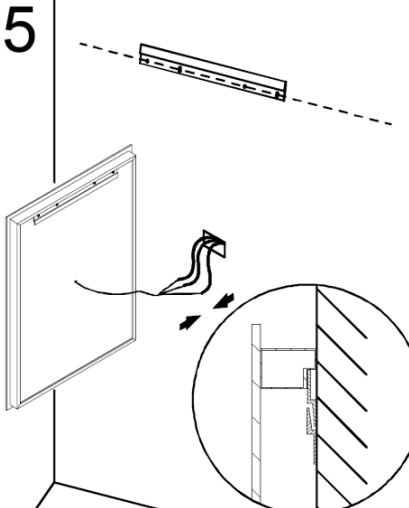

Hang the mirror to the wall and make sure the bracket in the back of the mirror lineup with the mounting bracket properly.

6

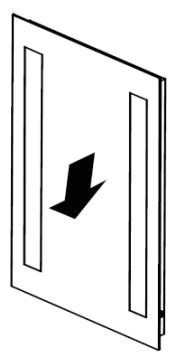

Press the mirror down slightly and make sure the brackets fit properly.



- Using the wall studs to hang the mirror is highly recommended.
- This mirror is NOT designed to work with a dimmable wall switch.

# INSTALLATION DIMENSIONS

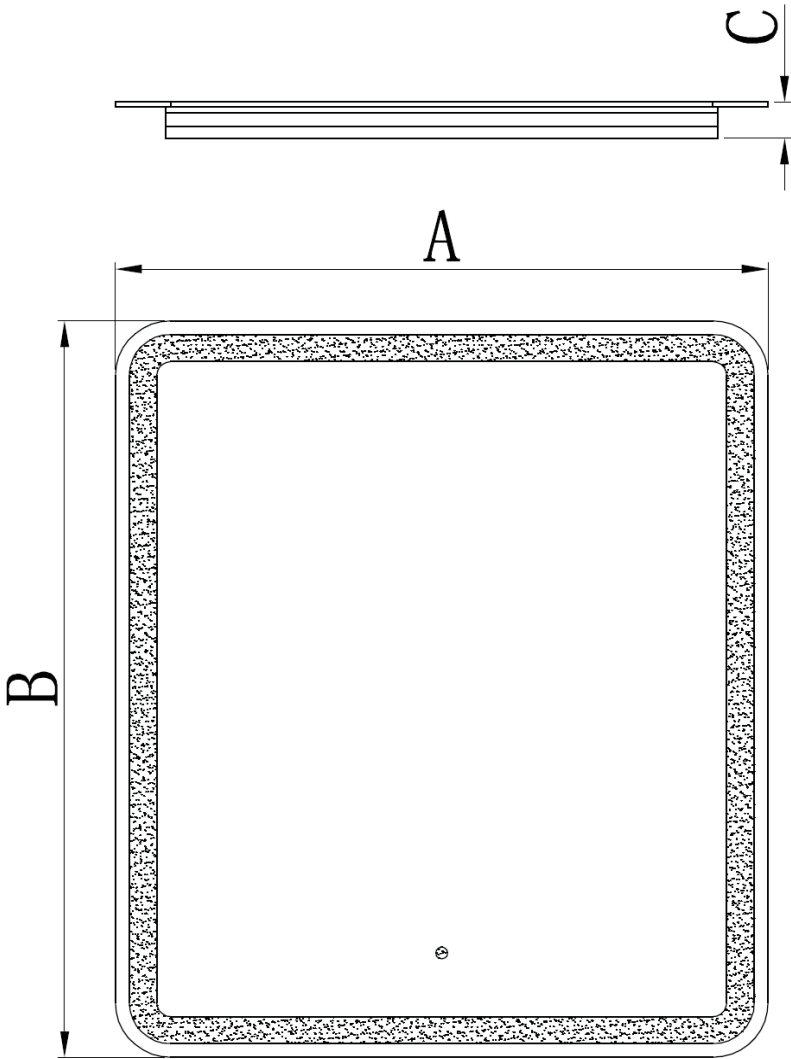

Model #	A	B	C
MM4040RDLED	40	40	1 5/8
MM5636RDLED	56	36	1 5/8



### **IR sensor**

- a. The IR sensor is located in front of the mirror at the bottom right corner.
- b. Move your hand across the IR sensor to turn the lights on or off.
- c. The distance between your hand and the sensor should be approx. 1”.

## **CARE AND MAINTENANCE**

Clean the mirror with a soft, damp cloth and dry thoroughly with a soft towel. Do NOT allow the edges of the mirror to get or remain wet over a period of time. Please do NOT use glass cleaner that contains ammonia or vinegar. Never spray any cleaner directly onto a mirror. Instead apply the cleaner to a soft cloth and then wipe the mirror. Make sure no commercial cleaner comes in contact with the edge or backing.

## **WARRANTY**

### **DEFECTIVE GOODS CONSUMER WARRANTY**

Miseno inspects all of its products prior to shipment. We offer a 5-year Limited warranty on our electric mirror products. Defective products should be returned to place of purchase for replacement. However, if this is not possible, we accept returns on defective product with our written authorization. Returns will be handled by product replacement. Defects or damage caused to the product by the consumer do not qualify for warranty replacement.

### **SHORTAGE OR DAMAGED PRODUCTS**

All shipments are carefully inspected and counted before leaving our distribution centers. Please inspect carefully on receipt of merchandise, noting any discrepancy or damage on the carrier's freight bill at that time, and file a claim with the carrier within 10 days from receipt of order. Then contact our office. Deductions from invoices for shortages or damage claims will not be allowed.

### **RETURN NEW GOODS**

All claims for returns or adjustments must have prior approval and return authorization (RMA) number. Only original, sealed product in salable condition are eligible for a general return. Credit for authorized general returns will be issued at the net price paid for the product and may be subject to a 15% restocking/handling fee. Merchandise is to be returned via prepaid freight. All unauthorized returns will be refused or subject to a 25% restocking/handling fee.

# REPLACEMENT PARTS

Part	Description
1	Mirror
2	Aluminum Frame
3	Polycarbonate Cover
4	LED Strip
5	LEDDriver
6	IR Sensor Driver
7	IR Sensor Switch
8	Mounting Bracket
9	Cable Gland
10	Aluminum Bracket
11	Galvanized Plate

