

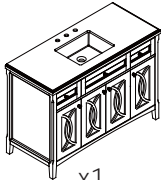

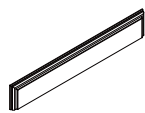

Installation Instructions

Notes: We recommend that you rough-in the drain and water lines after receiving the unit.
 The vanity should be installed by a professional plumber.
 Drainer pipe and trap are not included.
 If you experience any difficulties with this product, do not return to the point of purchase. Please contact MISENO directly at infoservice@miseno.com, And we will help resolve your issue.

	A (cabinet)	B (back splash)	C (screw)	D (handle)
Part List	 x1	 x1	 x7	 x7
Tools required	 screwdriver(cross)	 silicone	 level	 tape measure

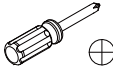
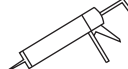
Step 1

CAUTION
 Handle the backsplash with extreme care!
 Stone backsplashes are very fragile.
 Always handle gently and place them flat on a soft surface.

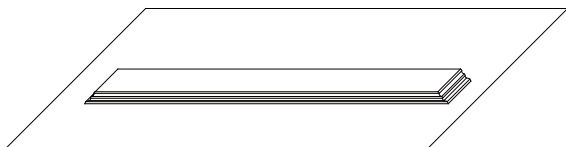

Step 2

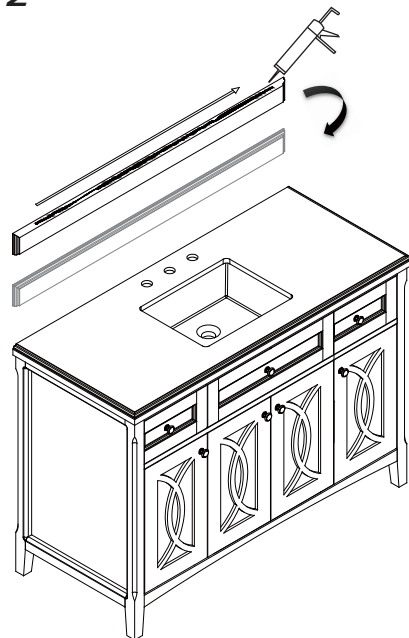

Step 3

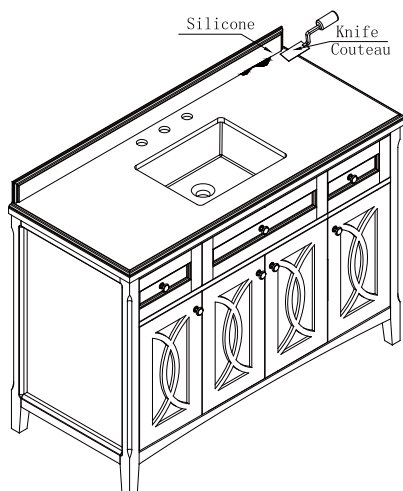

Step 4

