

## Operating Instructions Freezer













It is **essential** to read the operating and installation instructions before setup, installation, and commissioning. This prevents both personal injury and damage to the appliance.

# Contents

---

<b>IMPORTANT SAFETY INSTRUCTIONS</b> .....	5
<b>Caring for the environment</b> .....	16
<b>Installation</b> .....	17
Installation site.....	17
Side-by-side combinations .....	18
Climate range .....	19
Ventilation.....	19
Cabinet door.....	20
– Weight of the door panel .....	20
Horizontal and vertical gaps.....	21
Installation dimensions.....	23
Installation in a tall cabinet/side view .....	23
Connections and ventilation.....	24
Limiting the opening angle of the appliance door .....	25
Water connection .....	26
Information on the plumbed-water connection.....	26
Water supply .....	27
Electrical connection .....	29
<b>Saving energy</b> .....	31
<b>Guide to the appliance</b> .....	32
Status display.....	34
Using the appliance .....	34
Settings mode  .....	35
Adjusting the interior fittings.....	37
Ice- & PizzaBox.....	37
Tilting the top drawer .....	37
Accessories supplied .....	38
Optional accessories.....	38
<b>Switching on and off</b> .....	39
Before using for the first time.....	39
Connecting the appliance .....	39
Switching on the appliance .....	39
Switching off the appliance.....	39
To note when switching off for longer periods of time .....	40
<b>The correct temperature</b> .....	41
Temperature display .....	41
Setting the temperature.....	42
Possible temperature settings.....	42

<b>Using SuperFrost</b> .....	43
<b>Selecting additional settings</b> .....	44
Explanation of the different settings.....	44
Party mode  .....	44
Switching the safety lock function  /  on .....	44
Sabbath mode  .....	45
Information on Sabbath mode <b>i</b> .....	45
Changing the time before the door alarm  is triggered .....	46
Miele@home .....	46
Changing the volume of the alarms and audible signals  /  .....	48
Adjusting the display brightness  .....	48
Switching off Demo mode  .....	49
Resetting the settings to their default settings  .....	49
Information <b>i</b> .....	49
<b>Temperature and door alarm</b> .....	50
<b>Freezing and storing food</b> .....	52
What happens when you freeze fresh food? .....	52
Maximum freezing capacity .....	52
Storing frozen food.....	52
Home freezing .....	53
Storage time for frozen food.....	54
<b>Making ice cubes</b> .....	55
Switching the ice maker  on and off.....	56
<b>Defrosting</b> .....	57
<b>Cleaning and care</b> .....	58
Cleaning agents.....	58
Preparing the refrigeration appliance for cleaning .....	59
Cleaning the interior of the appliance .....	59
Cleaning accessories by hand or in the dishwasher .....	60
Removing, dismantling, and cleaning accessories .....	60
Cleaning the door seal .....	65
Cleaning the ventilation gaps .....	65
After cleaning .....	65
<b>Frequently asked questions</b> .....	66
<b>Causes of noises</b> .....	78

# Contents

---

<b>Customer Service</b> .....	79
Contact in the event of a fault .....	79
Appliance warranty and product registration .....	79
<b>Copyrights and licenses</b> .....	80

## IMPORTANT SAFETY INSTRUCTIONS

This refrigeration appliance complies with current safety requirements. Inappropriate use can, however, lead to personal injury and material damage.

Please read the operating and installation instructions carefully before using the refrigeration appliance for the first time. They contain important information on safety, installation, use, and maintenance. This is to protect yourself from injury, and from damaging your refrigeration appliance.

Miele expressly and strongly advises that you read and follow the instructions in the chapter on installing the refrigeration appliance as well as in the “IMPORTANT SAFETY INSTRUCTIONS”.

Miele cannot be held liable for injury or damage caused by non-compliance with these instructions.

Keep these instructions in a safe place and pass them on to any future owner.

### **Appropriate use**

- ▶ This appliance is intended for use in domestic households and similar residential environments such as
  - staff kitchen areas in shops, offices and other working environments
  - farm houses and by clients in hotels, motels and other residential type environments
  - bed and breakfast type environments
  - catering and similar non-retail applications.

This appliance is not intended for use outdoors, in damp environments or in places exposed to rain.

## IMPORTANT SAFETY INSTRUCTIONS

---

▶ This appliance is intended for domestic use only for storing deep frozen food, freezing fresh food and for making ice.

Any other usage is not supported by the manufacturer and could be dangerous.

▶ This refrigeration appliance is not suitable for storing and keeping cool medicines, blood plasma, laboratory preparations, or other similar substances or products that are subject to the Medical Device Directive. Incorrect use of the refrigeration appliance for such purposes may cause deterioration of the items stored. The refrigeration appliance is also not suitable for use in areas where there is a risk of explosion.

Miele cannot be held liable for damage resulting from incorrect or improper use or operation.

▶ This refrigeration appliance may only be used by people (including children) with reduced physical, sensory, or mental capabilities or lack of experience and knowledge if they are supervised while using it.

The refrigeration appliance may only be used by these people without supervision if they have been shown how to use it in a safe way and recognize and understand the consequences of incorrect operation.

### **Safety with children**

▶ Children should be supervised in the vicinity of the appliance.

▶ Children may only use the appliance even without supervision if they have been shown how to use it in a safe manner, and if they are able to recognize and understand the potential risks of improper use.

▶ Children must not clean or service the appliance unless they are under supervision.

▶ To reduce the risk of injury, do not allow children to play in, on or near the appliance.

# IMPORTANT SAFETY INSTRUCTIONS

▶ Ensure that any packing material is disposed of safely and kept out of the reach of children. DANGER of suffocation!

## Technical safety

▶ The coolant circuit has been checked for leaks. The refrigeration appliance complies with statutory and regulatory requirements.



▶ The symbol is located on the compressor and indicates the danger of inflammable materials. Do not remove the label.

**WARNING!** The refrigerant inside the appliance (details on the data plate) is environmentally friendly but flammable.

The use of this refrigerant does, however, sometimes lead to a slight increase in the noise level of the appliance. In addition to the noise of the compressor, you might be able to hear the refrigerant flowing around the cooling circuit. Unfortunately, this cannot be avoided, but it does not affect the performance of the refrigeration appliance.

**WARNING!** When transporting and installing the refrigeration appliance, ensure that no parts of the cooling circuit are damaged.

Splashes of refrigerant can damage the eyes and leaking refrigerant can ignite.

In the event of damage:

- Avoid open flames or anything which creates a spark.
- Disconnect the refrigeration appliance from the power supply.
- Ventilate the room where the refrigeration appliance is located for several minutes.
- Contact Miele Customer Service.

## IMPORTANT SAFETY INSTRUCTIONS

---

- ▶ The more refrigerant there is in a refrigeration appliance, the larger the room it should be installed in. In the event of a leakage, if the appliance is in a small room, there is the danger of a combustible gas/air mixture building up. For every 8 g of refrigerant, at least 3' 3" (1 m)<sup>3</sup> of room space is required. The amount of refrigerant in the refrigeration appliance is stated on the data plate inside the appliance.
- ▶ To avoid the risk of damage to the appliance, make sure that the connection data (fuse rating, frequency and voltage) on the data plate corresponds to the household supply. Check that this is the case before connecting the appliance. Consult a qualified electrician if in any doubt.
- ▶ The electrical safety of the appliance can only be guaranteed when correctly grounded. It is essential that this standard safety requirement is met. If in any doubt please have the electrical installation tested by a qualified electrician.
- ▶ Temporary or permanent operation on an autonomous power supply system or a power supply system that is not synchronized with the grid power supply (e.g., island networks, back-up systems) is possible. A prerequisite for operation is that the power supply system complies with national and local codes. The function and operation of the protective measures provided in the domestic electrical installation and in this Miele product must also be maintained in isolated operation or in operation that is not synchronized with the grid power supply, or these measures must be replaced by equivalent measures in the installation.
- ▶ If the power cord supplied is damaged, it must only be replaced by an original part to prevent a hazard for the user. Miele can only guarantee the safety of the appliance when original Miele parts are used.
- ▶ Do not connect the appliance to the electrical supply with a power bar or extension cord. These are a fire hazard and do not guarantee the required safety of the appliance.



## IMPORTANT SAFETY INSTRUCTIONS

---

- ▶ If moisture gets into electrical components or into the power cord, it could cause a short circuit. Therefore, do not operate the machine in areas where there may be moisture or splashing water (e.g., garages, laundry rooms).
- ▶ This appliance must not be installed and operated in mobile installations (e.g. on a ship).
- ▶ Do not use a damaged appliance. It could be dangerous. Check the appliance for visible signs of damage.
- ▶ For safety reasons, this appliance may only be used after it has been built in.
- ▶ The machine must be disconnected from the power supply during installation, maintenance, and repair work, and installation work on the fresh water connection. The machine is only completely isolated from the power supply when:
  - the fuses have been switched off, or
  - the circuit breaker has been removed completely, or
  - the power cord has been unplugged. Pull on the plug and not on the power cord when disconnecting it from the power supply.
- ▶ Unauthorized installation, maintenance, and repairs, or a faulty fresh water connection can cause considerable danger for the user. Installation, maintenance, and repairs, installation work on the fresh water connection, and all repairs on the ice/water outlet must only ever be carried out by a Miele authorized technician.
- ▶ The ice cube maker must only be connected to a cold water line.
- ▶ Miele cannot be held liable for damage caused by a faulty connection to the fresh water supply.
- ▶ Any manufacturer's warranty may be void if the appliance is not repaired by a Miele approved service technician.

## IMPORTANT SAFETY INSTRUCTIONS

---

- ▶ Faulty components must only be replaced by genuine Miele replacement parts. Miele can only guarantee the safety standards of the appliance when Miele replacement parts are used.
- ▶ This refrigeration appliance is supplied with a special bulb to cope with particular conditions (e.g., temperature, moisture, chemical resistance, abrasion resistance, and vibration). This bulb must only be used for the purpose for which it is intended. The bulb is not suitable for room lighting. Replacement bulbs may only be installed by an authorized technician or by Miele Customer Service. This refrigeration appliance contains several light sources with at least energy efficiency class G.

### **Proper installation**

- ▶ When installing the refrigeration appliance, it is a mandatory requirement to follow the installation instructions supplied with it.
- ▶ Always wear protective gloves when transporting and installing the refrigeration appliance.
- ▶ Two people are required to install the appliance.
- ▶ Change the door hinging (if necessary) as described in these installation instructions.
- ▶ Only install the refrigeration appliance in a solid, rectangular, and level housing unit, positioned on an even and level floor.

# IMPORTANT SAFETY INSTRUCTIONS

---

## Correct use

- ▶ This refrigeration appliance is designed for use within specific ambient temperatures (climate range). Do not use in ambient temperatures for which it is not designed. The climate range is stated on the data plate in the interior cabinet of the refrigeration appliance. A lower ambient temperature will cause the compressor to switch off for longer periods, meaning that the refrigeration appliance is unable to maintain the required temperature.
- ▶ **WARNING! DANGER of overheating!** Do not cover or block the air vents. This can impair the efficiency of the appliance, increase the power consumption and cause damage to the appliance.
- ▶ If storing food which contains a lot of fat or oil in the appliance, make sure that it does not come into contact with plastic components as this could cause stress cracks or break the plastic.
- ▶ Risk of fire and explosion. Do not store any explosive materials or products containing flammable propellants (e.g., spray cans) in the appliance. Electrical components can cause flammable mixes of gases to ignite.
- ▶ **WARNING! Risk of explosion.** Do not operate any electrical equipment (e.g., an electric ice-cream maker) inside the refrigeration appliance. Risk of sparking and explosion.
- ▶ Risk of injury and damage. Do not store cans or bottles containing carbonated drinks or liquids which could freeze in the freezer section. Otherwise they could burst.
- ▶ Risk of injury and damage. When chilling drinks in the freezer section, make sure that bottles are not left in for more than one hour. Otherwise they could burst.
- ▶ Risk of injury. Never handle frozen food or the metal parts of the appliance with wet hands. Your hands may freeze to the frozen food or to the metal.

## IMPORTANT SAFETY INSTRUCTIONS

---

- ▶ Risk of injury. Do not take ice cubes out with your bare hands and never place ice cubes or ice pops in your mouth straight from the freezer section. The very low temperature of the frozen food can cause frost burn to the lips and tongue.
- ▶ Do not refreeze partially or fully defrosted food. Consume defrosted food as soon as possible, as it will lose its nutritional value and spoil if left for too long. Defrosted food may only be refrozen after it has been cooked.
- ▶ When eating stored food, there is a danger of food poisoning. Storage times will depend on several factors, including the freshness and quality of the food, as well as the temperature at which it is stored. Observe the manufacturer's "use-by" dates and storage instructions.

### **Accessories and parts**

- ▶ Use only genuine original Miele parts. If parts or accessories from other manufacturers are used, the warranty may become invalid.
- ▶ Miele will guarantee to supply functional spare parts for a minimum of 10 years and up to 15 years following the discontinuation of your refrigeration appliance.

# IMPORTANT SAFETY INSTRUCTIONS

---

## Cleaning and maintenance

- ▶ Do not use any oil or grease on the door seals. They can cause the seals to deteriorate over time.
- ▶ **WARNING! DANGER** of injury and damage! Do not use any mechanical tools or other types of aid which are not recommended by the manufacturer to accelerate the defrosting process.
- ▶ Never use a steam cleaner to clean the appliance. The steam can reach the electrical components and cause a short circuit.
- ▶ Sharp edged or pointed objects will damage the evaporator, causing irreversible damage to the appliance. Do not use sharp edged or pointed objects to
  - remove frost or ice,
  - separate frozen foods or remove ice trays.
- ▶ Never place electric heaters or candles in the appliance to defrost it. These can damage the plastic parts.
- ▶ Do not use defrosting sprays or de-icers, as they could contain substances which could damage the plastic parts or which might cause the build-up of gases and pose a danger to health.

## Transport

- ▶ To avoid damage to the appliance, always transport it upright and in its packaging.
- ▶ Risk of injury and damage. The refrigeration appliance is very heavy and must be transported by two people.

# IMPORTANT SAFETY INSTRUCTIONS

---

## Disposal of your old appliance

▶ **DANGER!** Risk of child entrapment! Children could become trapped in the refrigeration appliance and could suffocate.

- Remove the appliance door(s).
- Remove the drawers.
- Leave the adjustable shelves in the refrigeration appliance so children cannot climb inside.
- If your old refrigeration appliance has a door lock, destroy it. This will prevent the risk of children playing accidentally locking themselves in and endangering their lives.

▶ Risk of electric shock!

- Cut the electrical plug off the power cord.
- Cut the power cord off the old appliance.

▶ Dispose of them separately from the appliance.

▶ Ensure that the appliance is not stored in the vicinity of gasoline or inflammable gases and liquids during and after disposal.

▶ **WARNING!** Risk of fire due to escaping oil or refrigerant!

The refrigerant and oil inside the appliance are flammable. In high enough concentrations, escaping refrigerant or oil may ignite if they come into contact with an external heat source.

During disposal, make sure that the cooling circuit is not damaged in order to prevent refrigerant and oil escaping in an uncontrolled manner (see the data plate for details of the refrigerant).

▶ If your old refrigeration appliance has a door lock, destroy it. This will prevent the risk of children playing accidentally locking themselves in and endangering their lives.

▶ Splashes of coolant can cause damage to the eyes. Be careful not to damage any part of the pipework while awaiting disposal, e.g. by

- puncturing the coolant channels in the evaporator,
- kinking any pipework,

## IMPORTANT SAFETY INSTRUCTIONS

---

- scratching the surface coating.

### **Symbol on the compressor (depending on model)**

This information is only relevant for recycling. There is no risk during normal operation.



- ▶ The oil in the compressor can be fatal if swallowed or if it penetrates the airways.

### **Symbol on the rear of the appliance (depending on model)**

This label or a similar one is only relevant for recycling. Do not remove the label.



- ▶ This information refers to the foamed-in panels in the door and/or the housing.

# Caring for the environment

---

## Disposal of packaging material

The packaging is designed to protect the appliance from damage during transportation. The packaging materials used are selected from materials which are environmentally friendly for disposal and should be recycled.

Ensure that any plastic wrappings, bags, etc. are disposed of safely and kept out of the reach of children. Return the packaging to your dealer.

## Disposing of your old appliance

Electrical and electronic appliances contain many valuable materials. They also contain certain materials, compounds, and components which were essential for their correct functioning and safety. These could be hazardous to your health and to the environment if disposed of with household waste or if handled incorrectly. Please do not, therefore, dispose of your old appliance with household waste.



Take care not to damage your refrigerator before or during disposal in an authorized, environmentally-friendly manner.

This is to ensure that refrigerant in the cooling circuit and oil in the compressor is contained, and will not leak into the environment.

Instead, please make use of officially designated collection and disposal locations to dispose of and recycle electrical and electronic appliances in your

local community, with your dealer, or with Miele, free of charge. By law, you are solely responsible for deleting any personal data from the appliance prior to disposal. You are legally obliged to remove any old batteries which are not securely enclosed by the appliance and to remove any lamps without destroying them, where this is possible. These must be taken to a suitable collection point where they can be handed in free of charge. Please ensure that your old appliance poses no risk to children while being stored for disposal.



## Installation site

 **WARNING!** Risk of damage and injury due to the refrigeration appliance tipping over.

This refrigeration appliance is very heavy and can tip forward when the door is open.

Keep the appliance door(s) closed until the refrigeration appliance has been built in. The refrigeration appliance must be secured in its building-in niche in accordance with the operating and installation instructions.

 Fire hazard and risk of damage from appliances that give off heat.

Appliances that give off heat can catch fire and set fire to the refrigeration appliance.

This refrigeration appliance must not be installed underneath a cooktop.

 Fire hazard and risk of damage from open flames.

Open flames can set fire to the refrigeration appliance.

Keep open flames (such as a candle) away from the refrigeration appliance.

This appliance should be installed in a dry, well-ventilated room.

 Risk of damage due to high humidity.

In environments with high humidity, condensation can build up on external refrigeration-appliance panels.

This condensate can cause corrosion on external appliance panels.

Install the refrigeration appliance in a dry and/or air-conditioned room with sufficient ventilation.

After installation please make sure that the appliance door(s) closes (close) properly and the refrigeration appliance is installed in accordance with these installation instructions.

The specified ventilation specifications must be observed.

When deciding where to install your refrigeration appliance, please bear in mind that it will use more energy if installed near to a heater, a range, or another appliance that gives off heat. Avoid direct sunlight.

The higher the ambient temperature, the longer the compressor runs and the higher the energy consumption is.

# Installation

---

When installing the refrigeration appliance, please note the following:

- The electrical outlet must be easily accessible in an emergency and not concealed behind the appliance.
- The electrical plug and power cord must not touch the rear of the refrigeration appliance as they could be damaged by vibrations from the appliance.
- Do not plug in other appliances behind the refrigeration appliance.
- When installing the refrigeration appliance, make sure that the power cord does not get trapped or damaged.
- Do not position or operate power bars, distributor strips, or other electronic devices (such as halogen transformers) at the rear of the appliance.
- The floor at the installation site must be horizontal and level and must be as high as the surrounding floor.

## Side-by-side combinations

 Risk of damage due to condensation on external appliance panels. In environments with high humidity and a lack of ventilation, condensation can build up on external appliance panels, which can cause corrosion. Do not place refrigeration appliances directly next to or on top of one another.

Your refrigeration appliance can be installed with another refrigeration appliance next to it as it is equipped with integrated heaters in the side panels. Each of the two refrigeration appliances must be built into a separate housing unit.

## Climate range

This refrigeration appliance is designed for use within specific ambient temperatures (climate range). Do not use in ambient temperatures for which it is not designed.

A lower ambient temperature leads to the compressor switching off for longer periods. This can cause the internal temperature in the refrigeration appliance to rise with the risk of food deteriorating and going off.

The climate range is stated on the data plate in the interior cabinet of the refrigeration appliance.

Climate range	Ambient temperature
SN	50 to 90°F/+10 to +32°C
N	60 to 90°F/+16 to +32°C
ST	60 to 100°F/+16 to +38°C
T	60 to 109°F/+16 to +43°C

A freezer from the SN climate range can operate without any difficulties in rooms with a cooler ambient temperature (down to +41°F/5°C).

## Ventilation

 **WARNING!** Fire hazard and risk of damage due to insufficient ventilation.

If the refrigeration appliance is not ventilated sufficiently, the compressor will run more frequently and for longer periods. This causes increased energy consumption and an increased compressor operating temperature, which can result in damage to the compressor.

Please ensure that there is adequate ventilation around the refrigeration appliance.

It is essential to observe the required ventilation gaps.

The ventilation gaps must never be obstructed.

They must also be cleaned on a regular basis to remove dust.

There must be a gap of at least ½ inch (13 mm) between the back of the appliance and the rear wall. If this gap is not maintained, this will result in increased energy consumption.

Air at the back of the refrigeration appliance gets warm. The appliance housing unit must therefore be constructed to allow sufficient space for ventilation (see “Installation dimensions” and the installation instructions provided).

- To ensure ventilation an air channel of a minimum 1 1/2" (40 mm) depth must be provided at the back of the appliance.
- The ventilation slits in the toe-kick, in the cabinet and under the top of the cabinet must provide a total

# Installation

passage volume of at least 31"² (200 cm²) to allow the warm air to dissipate unimpeded.

- If you wish to fit a grille in the ventilation openings, the ventilation openings must be larger than 31"² (200 cm²). The passage volume of 31"² (200 cm²) is the total area of the opening slits in the grille.
- Important! The larger the ventilation slits, the more economically the appliance will work.

## Lower ventilation slit

The appliance can be ventilated via the cabinet plinth with the ventilation grille supplied or with a minimum ventilation opening of 31 in² cross-section area. When using the grille supplied, please proceed as follows:

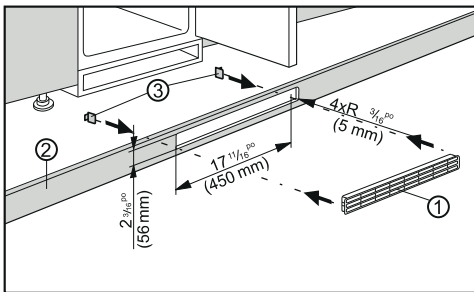

- Cut an opening in plinth ② as shown in the diagram.
- Place ventilation grille ① in the opening.
- Push snap fasteners ③ into the ventilation grille from behind until the hooks touch the plinth.
- Reinstall the plinth with the ventilation grille.

## Cabinet door

An cabinet door is required.

The cabinet door must be at least 5/8" (16 mm) / 3/4" (19 mm) thick.

### - Weight of the door panel

⚠ If the door panel is too heavy damage can occur.

Installing a door panel which is heavier than the maximum permitted weight could damage the hinges. This can cause subsequent functional problems.

Before installing the door panel, ensure that the weight of the door panel does not exceed the maximum permitted weight.

The maximum permissible weight of the door panel is:

Refrigeration appliance	lb (kg)
FNS 7794 E	57 (26)

## Horizontal and vertical gaps

Depending on the style of kitchen cabinetry, the thickness and edge radius of the custom door panel and the gap that runs around the door, vertically and horizontally, are specified.

It is essential to pay attention to the following:

### - Horizontal gap

The gap between the door panel and the housing-unit door above or below it must be at least 1/8" (3 mm).

### - Vertical gap

If the gap between the refrigeration-appliance door panel and the adjoining housing-unit door or wall on the hinged side is too small, the appliance door could collide with the adjoining housing-unit door or wall when opened.

It may be necessary to adjust the size of this gap to suit the thickness and edge radius of the door panel.

This must be taken into consideration when planning your kitchen and when replacing an old refrigeration appliance with a new one to ensure the installation conditions required are met.

Door panel thickness <b>A</b> [in (mm)]	Gap <b>X</b> [in (mm)] for different edge radii <b>B</b>			
	R0	R1.2	R2	R3
≥5/8" - 3/4" (16–19)	min. 1/8" (3)			
13/16" (20)	3/16" (5)	3/16" (4)	3/16" (4)	1/8" (3.5)
13/16" (21)	3/16" (5.5)	3/16" (5)	3/16" (4.5)	3/16" (4)
7/8" (22)	1/4" (6.5)	1/4" (6)	3/16" (5.5)	3/16" (5)

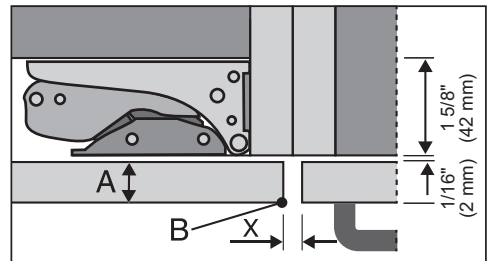

Adjoining housing-unit door

A = Door-panel thickness

B = Edge radius

X = Gap

# Installation

---

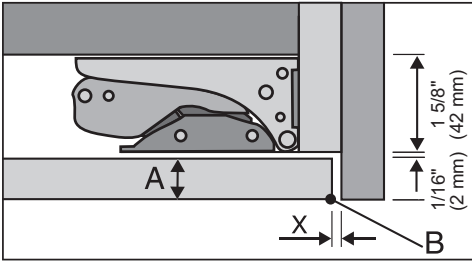

Adjoining side wall

A = Door-panel thickness

B = Edge radius

X = Gap

**Tip:** Fit a spacer between the housing-unit body and the side wall. This way you will get a sufficiently wide gap.

**Tip:** Please also see the diagram and information on the following pages on calculating the cabinet door height.

## Installation dimensions

### Installation in a tall cabinet/side view

All dimensions are given in inches (mm).

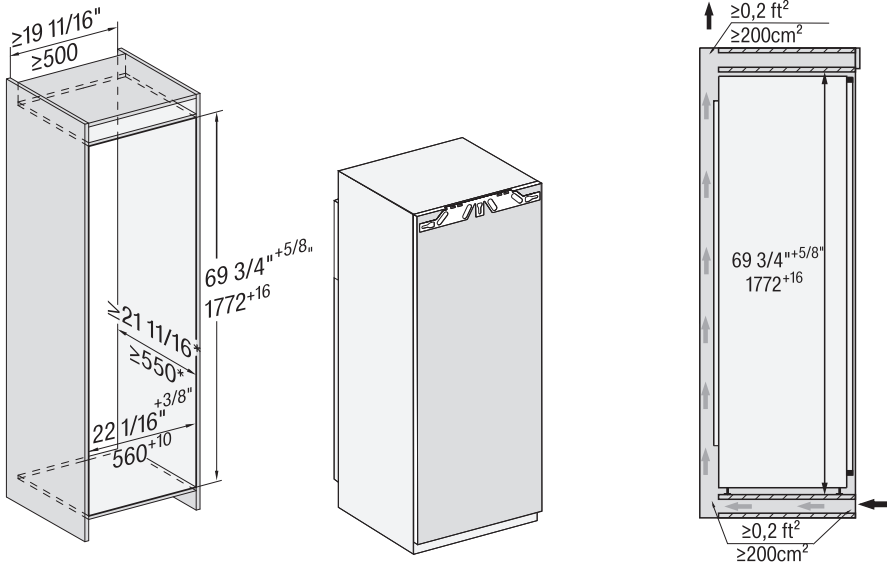

\* The declared energy consumption was achieved with a niche depth of  $22 \frac{1}{16}''$  (560 mm). The refrigeration appliance is fully capable of functioning at a niche depth of  $21 \frac{5}{8}''$  (550 mm) but will consume slightly more energy.

Before installation, ensure the housing-unit dimensions are the correct size.

# Installation

## Connections and ventilation

All dimensions are given in inches (mm).

The specified ventilation cross-sections must be adhered to in order to ensure the correct functioning of the refrigeration appliance.

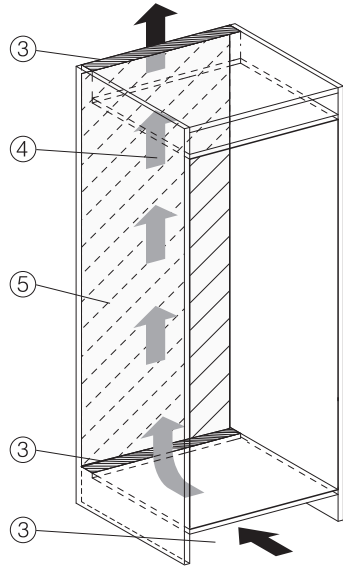
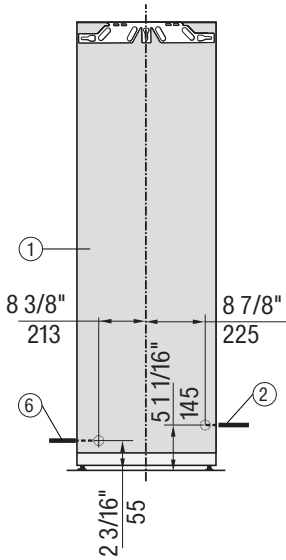

- ① Front view
- ② Power cord, length = 7' 2" (2,200 mm)  
A longer power cord is available to order from Miele Customer Service.
- ③ Water connection, length = 6' 6" (2,000 mm)
- ④ Ventilation cut-out min. 31"² (200 cm²)
- ⑤ Ventilation
- ⑥ No connections permitted in the rear panel



## Limiting the opening angle of the appliance door

The door hinges are set at the factory to enable the appliance door to be opened wide.

If the opening angle of the appliance door needs to be limited to approx. 90°, the hinge can be adjusted to accommodate this.

The locking pins for limiting the door opening must be installed before the appliance is installed.

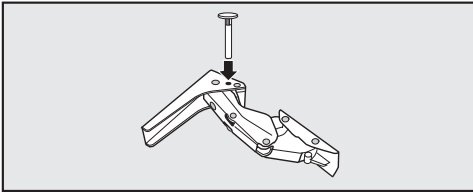

- Insert the locking pins supplied for limiting the door opening into the hinges from above.

The appliance door opening angle is now limited to approximately 90°.

# Installation

## Water connection

### Information on the plumbed-water connection

 Risk of injury and appliance damage if appliance is not connected properly.

Failing to connect the appliance properly can result in personal injury and/or material damage.

The appliance may only be connected to the plumbed-water connection by qualified specialists.

 Disconnect the refrigeration appliance from the power supply before connecting it to the water supply.

Close the shut-off valve before connecting the refrigeration appliance to the water supply.

 **WARNING!** Risk to health and risk of damage due to contaminated water!

The quality of the incoming water must conform to the requirements for drinking water in the country where the refrigeration appliance is being used.

Connect the refrigeration appliance to the drinking-water supply.

This appliance meets the requirements of IEC 61770 and EN 61770.

Connection to the water supply must comply with the applicable regulations in the country where the appliance is being installed. All appliances and systems used to supply water to the refrigeration appliance must also comply with the applicable regulations in the respective country.

For correct functioning (dispensing rate, size of ice cubes, noise level) the water connection pressure needs to be between 21.7 psi and 90 psi (1.5 bar and 6.2 bar).

If the water connection pressure exceeds 90 psi (6.2 bar), a pressure reducing valve must be fitted.

The water supply line and the inlet solenoid valve on the refrigeration appliance are suitable for a water connection pressure of up to 145 psi (10 bar).

Use fresh water to ensure that the quality of the ice cubes remains high. Connect the hose to the fresh water supply and avoid connection to a water supply in which the water might stagnate.

Only use the hose supplied. The hose must not be shortened, extended, or replaced by a different hose. Dispose of old hoses.

The hose must only be replaced by an original Miele spare part. The food-grade hose is available to order from the Miele online shop, from Miele Customer Service, or from your local Miele dealer.

A shut-off valve must be provided between the hose and the plumbed-water connection to ensure that the water supply can be cut off if necessary.

Make sure that the shut-off valve is still accessible after the appliance has been installed.

## Water supply

Ensure that the connections are tight and leak-proof.

 Risk of damage to the hose. The water supply from the shut-off valve to the ice-cube maker has been interrupted. Do not bend or damage the hose.

A shut-off valve with a metric R3/4 thread must be incorporated when connecting to the water supply.

The solenoid valve is located at the back of the refrigeration appliance on the bottom right. It also has a metric R3/4 thread.

## – Connecting the hose to the refrigeration appliance

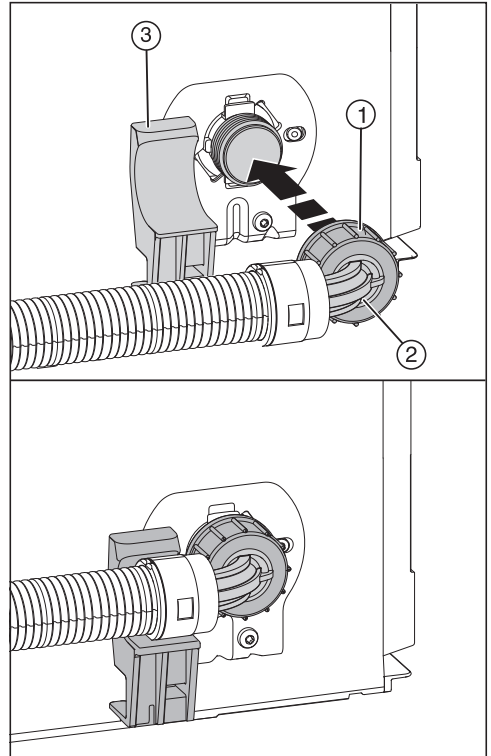

- Pull the cover off the thread of the solenoid valve.
- Position the angled end of the hose ② horizontally on the holder ③ and hold onto it securely.
- Screw the nut ① onto the thread by hand until it is securely in place.

# Installation

---

## – Connecting the hose to the shut-off valve

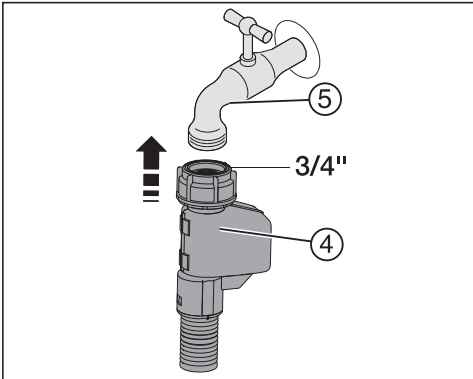

- Connect the nut ④ to the shut-off valve ⑤.

## – Checking the plumbed-water connection

Test the water connection for leaks before installing the appliance in the niche.

- Slowly open the shut-off valve ⑤ and check the screw connections.

## Electrical connection



**Risk of electric shock!**

The appliance must only be switched on when it has been installed in accordance with the installation instructions.

Ground the appliance.

The appliance must not be grounded via a gas pipe.

If in doubt, have a suitably qualified and experienced electrician check that the installation complies with relevant regulations.

Do not install a fuse into neutral current or grounding electrical circuit.

Do not use extension cords or ungrounded (two prong) adapters.

Do not use a frayed or damaged power cord.



**Risk of electric shock!**

For protection against electric shock, this appliance is equipped with a pole-free plug which is protected against reverse polarity. The electrical outlet must be properly grounded.

Do not remove the round grounding connector pin from the plug.

Use only a grounded plug adapter.

Wait for 1 hour after installation before plugging the appliance into the power supply. This allows coolant and refrigerator oil to settle in accordance with regulations.

Ensure that the voltage of the power supply corresponds with the connection voltage of the appliance. A power supply of 110–120 V, 60 Hz and 10–16 Amp, which is protected by a power switch or a fuse, is required to operate the appliance.

The manufacturer recommends operating the appliance on a dedicated circuit to avoid overloading the electrical circuit.

All relevant legal electrical, fire, and building regulations must be observed when installing the electrical outlet and/or the appliance.

In certain countries, appliances are required to be connected to the electrical supply via a wall-mounted ON/OFF switch.

To avoid the risk of fire, electric shock, or other injuries, the appliance must be installed and connected by a suitably qualified electrician in accordance with all relevant local and national regulations and standards, including fire prevention.

The socket must not be concealed behind the appliance and must be easily accessible so that the appliance can be quickly disconnected from the electrical supply in case of an emergency.

# Installation

---

If the outlet is no longer accessible after installation, an additional means of disconnection must be provided for all poles. Suitable means of disconnection include switches with an all-pole disconnect device with a contact opening of at least 1/8" (3 mm). These can be circuit breakers, fuses, and relays.

The plug and power cord must not come into contact with the back of the appliance as vibrations can cause damage to these components. This could result in a short circuit.

Do not plug other appliances into electrical outlet behind this appliance.

Temporary or permanent operation on an autonomous power supply system or a power supply system that is not synchronized with the grid power supply (e.g., island networks, back-up systems) is possible. A prerequisite for operation is that the power supply system complies with the specifications of EN 50160 or an equivalent standard. The function and operation of the protective measures provided in the domestic electrical installation and in this Miele product must also be maintained in isolated operation or in operation that is not synchronized with the grid power supply, or these measures must be replaced by equivalent measures in the installation.

If the power cord needs to be replaced, this must be performed by a qualified technician.

## Connecting the appliance

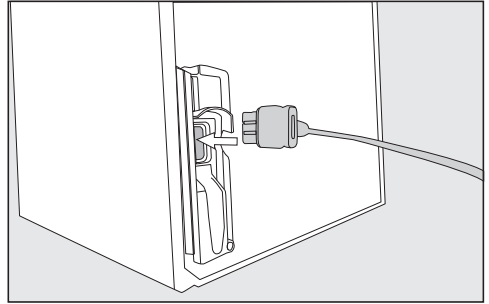

- Insert the electrical plug into the back of the refrigeration appliance.

Make sure that the electrical plug has clicked into position correctly.

- Insert the electrical plug of the refrigeration appliance into the socket.

The refrigeration appliance is now connected to the electricity supply.

## How to save energy:

- Installation location** The refrigeration appliance has to cool more often at higher ambient temperatures and consumes more energy in the process. Therefore, you should:
- Install the refrigeration appliance in a well-ventilated room.
  - Do not install the refrigeration appliance near to a heat source (heater element, range).
  - Protect the refrigeration appliance from direct sunlight.
  - Ensure an ideal ambient temperature of 68°F (20°C).
  - Clean the ventilation gaps on a regular basis to remove any dust.
- Temperature setting** The colder the temperature, the higher the energy consumption. The following settings are recommended:
- 0°F (-18°C) in the freezer section.
- Use** Energy consumption is increased by heat input and impeded air circulation. Therefore, you should:
- Only open the appliance door(s) when necessary and for as short a time as possible. Arrange the food in such a way that makes it easy to find in the appliance.
  - Always close the appliance door(s) properly after opening them.
  - Allow hot food and drinks to cool down before placing them in the refrigeration appliance.
  - Store food well packaged or covered.
  - Do not overfill the compartments to allow air to circulate.
  - Keep drawers and shelves arranged as they were when the appliance was delivered.
  - When placing food in the appliance, make sure that the ventilation slots are not blocked.

# Guide to the appliance

---

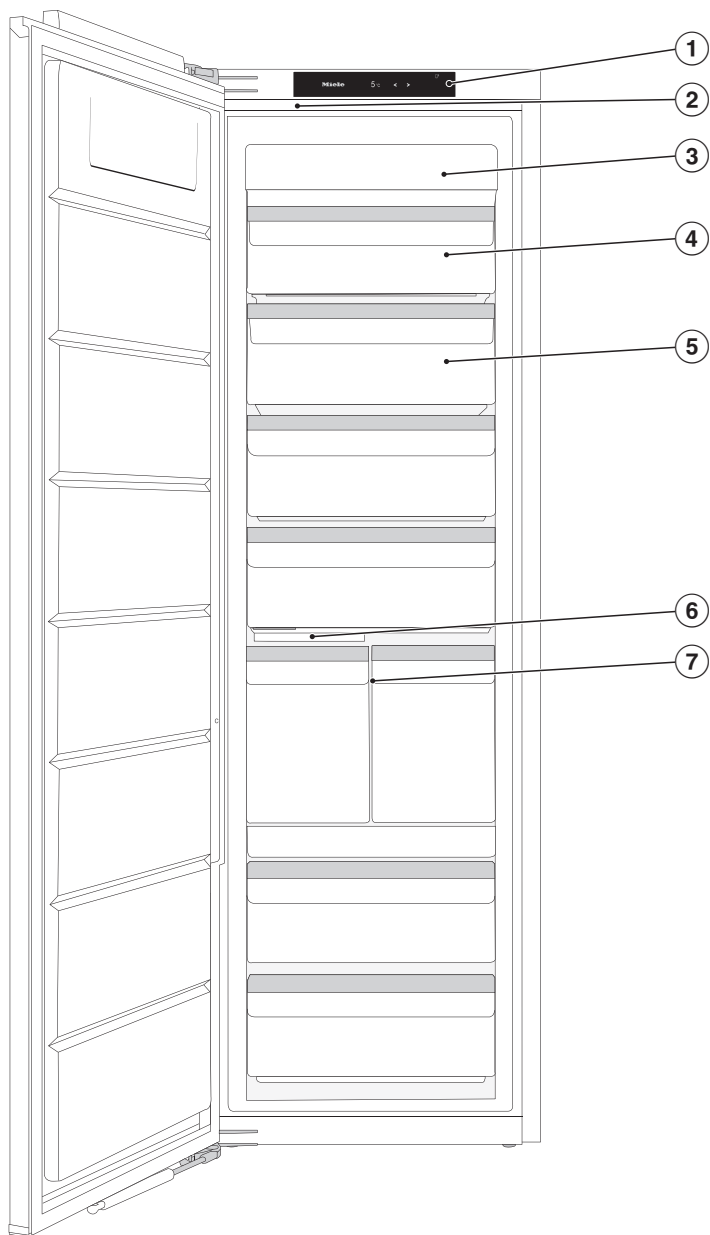



- ① Display
- ② Interior lighting
- ③ NoFrost module
- ④ Tiltable freezer drawer
- ⑤ Freezer drawers
- ⑥ Ice-cube maker with integrated ice cube tray and light
- ⑦ Ice- & PizzaBox

# Guide to the appliance

---

## Status display

The touch display can be scratched by pointed or sharp objects, e.g., pens. Only touch the display with your fingers. If your fingers are cold, the touch display may not react.

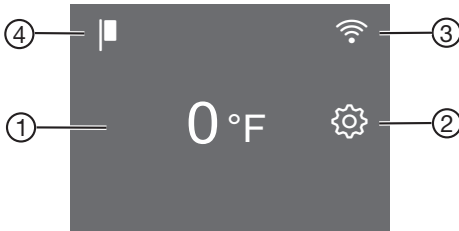

- ① Temperature display for freezer section
- ② Settings mode sensor control  for adjusting various settings in Settings mode
- ③ Display for Miele@home connection status (only visible when the Miele@home function has been set up)
- ④ Demo-mode display (only visible when the Demo-mode function has been switched on)

## Using the appliance











- Touch the area/symbol you want on the status display.
- Swipe left or right across the display until the value/symbol you want is shown in the middle.
- Tap on the option you want on the display to confirm.

The selected value/symbol will light up orange (except for a few exceptions).

- To leave the Settings level, tap on  or OK.

## Settings mode

In Settings mode, you can select the following appliance functions and alter their settings to some extent:

Symbol	Function	Factory default
	Switching the Party-mode function on or off (see “Selecting additional settings”)	Off
	Switching the ice-cube maker on and off (see “Making ice cubes”)	Off
	Switching the lock function on or off (see “Selecting additional settings”)	 (Off)
	Switching the Sabbath-mode function on or off (see “Selecting additional settings”)	Off
	Calling up information on the Sabbath-mode function (see “Selecting additional settings”)	—
	Changing the time before the door alarm is triggered (see “Selecting additional settings”)	1:00
	Setting up the Miele@home function for the first time, activating and deactivating WiFi, or resetting the network configuration (see “Selecting additional settings”)	APP
	Switching the keypad tone on or off	On
	Changing the volume of the alarms and audible signals or switch them off entirely (see “Selecting additional settings”)	On /level 5
	Changing the display brightness (see “Selecting additional settings”)	Level 4
°C / °F	Changing the temperature unit (°Celsius or °Fahrenheit)	°C

# Guide to the appliance

---

■	Switching the Demo-mode function off (only visible when switched on) (see “Selecting additional settings”)	Off
	Resetting to default settings (see “Selecting additional settings”)	—
i	Calling up information (model identifier and serial number) about your refrigeration appliance (see “Selecting additional settings”)	—
Ⓞ	Setting the cleaning position of the ice-cube tray (only appears if the ice-cube maker is switched on) (see “Cleaning and care”).	—

## Adjusting the interior fittings

### Ice- & PizzaBox

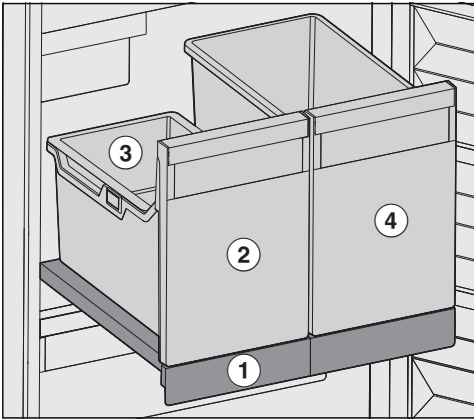

The Ice- & PizzaBox is located on a pull-out shelf ① and can only ever be pulled out as a whole.

There is a clip-on container ② in the ice cube drawer ③. The clip-on container can contain a normal amount of ice cubes. The clip-on container can be easily removed and reinserted for use. If you ever need a larger quantity of ice cubes, you can simply remove the clip-on container.

Pizza boxes can be placed vertically in the PizzaBox ④ next to it.

The pizza boxes can be conveniently removed and sorted.

In addition, you have a good overview of the stored pizzas.

You can also use the PizzaBox for storing other tall foods.

⚠ Risk of damage due to heavy loads.

Loading food which is too heavy can damage the drawers and the pull-out shelf.

Do not exceed the maximum load size of the pull-out shelf of 44 lb (20 kg).

### Tilting the top drawer

The top drawer can be tilted to make it easier to remove frozen food.

- Pull the drawer out.

The drawer is secured with pull-out stops and cannot fall out.

# Guide to the appliance

---

## Accessories supplied

### Ice cube scoop

## Optional accessories

A range of useful Miele accessories and care products are available for your appliance.

Optional accessories can be ordered from the Miele webshop or your Miele dealer.

## Before using for the first time

- Remove all packaging material and protective film.
- Clean the inside of the appliance and the accessories (see “Cleaning and care”).

## Connecting the appliance

- Connect the refrigeration appliance to the electricity supply as described in “Electrical connection”.

Miele will then appear on the appliance display, followed by .

## Switching on the appliance

- Open the appliance door.
- Tap  on the display.

The refrigeration appliance will start to cool and the interior lighting will come on.

When the set temperature is reached, the  symbol disappears, the temperature display lights up constantly, and the alarm stops.



- If the alarm disturbs you, tap .

The alarm will stop.

The refrigeration appliance will gradually reach the preset temperatures.

Do not place food in the freezer section until it has reached the preset temperature (min. 0°F/-18°C).

## Switching off the appliance

- Touch the temperature display on the display.
- Swipe right until  is shown in the middle.
- Tap .

The cooling and interior lighting are switched off.

 will appear in the display.

Please note: the refrigeration appliance is not disconnected from the power supply when it is switched off.

# Switching on and off

---

## To note when switching off for longer periods of time

If, during a long absence, the refrigeration appliance is switched off but not cleaned and the door is left shut, there is a danger of bacteria building up inside the appliance.  
It is essential to clean the refrigeration appliance.

If the refrigeration appliance is not going to be used for a longer period of time, observe the following:

- Turn the appliance off.
- Unplug the appliance's electrical plug or switch off the breaker.
- Empty the ice cube drawer.

 Risk of damage to the ice-cube maker.

If the water supply is cut off while the ice-cube maker is still in use, the water-intake pipe can freeze up.  
Turn the ice-cube maker off if the water supply is interrupted (e.g., while on vacation).

- Close the water supply shut-off valve.
- Clean the refrigeration appliance and leave the door open to air the appliance and avoid odors building up inside.



# The correct temperature

It is very important to set the correct temperature for storing food in the appliance. Bacteria will cause food which is not stored at the correct temperature to deteriorate rapidly. Temperature influences the growth rate of these bacteria. Reducing the temperature reduces their growth rate.

To freeze fresh food and to store frozen food for a long time, a temperature of **0°F (-18°C)** is required. At this temperature the growth of bacteria is generally halted. As soon as the temperature rises above 14°F (-10°C), the bacteria become active in the food again so it cannot be kept as long. For this reason, partially defrosted or defrosted food must not be re-frozen. Food may be re-frozen once it has been cooked (boiled or roasted), as the high temperatures achieved when cooking destroy most bacteria.

The temperature in the appliance will rise:

- the more often the appliance door is opened and the longer it is kept open
- the more food that is stored in it
- the warmer the food is that is being put into it
- the higher the ambient temperature surrounding the refrigeration appliance is. This refrigeration appliance is designed for use within specific ambient temperatures (climate range). Do not use in ambient temperatures for which it is not designed.

## Temperature display

In normal operation, the temperature display shows the current **maximum freezer section temperature** in the refrigeration appliance.

Depending on the ambient temperature and the temperature setting, it can take the appliance a few hours to reach the temperature required and for this temperature to then be shown as a constant temperature in the display.

# The correct temperature

---

## Setting the temperature

- Touch the temperature display on the display.
- Swipe left or right until the temperature you want is shown in the middle.
- Tap the temperature you want to confirm.

The temperature display will then change back to the current temperature in the refrigeration appliance.

## Possible temperature settings

- Freezer section: 5 to -18°F (-15 to -28°C)

## If you change the temperature setting:

- Check the temperature display after a few hours. It will take this long for an accurate reading to be given.
- Wait for approx. 6 hours if the refrigeration appliance is not very full.
- Wait for approx. 24 hours if the refrigeration appliance is full.

If, after this time, the temperature is still too high or too low:

- Adjust the temperature again.

## SuperFreeze ❄️

When switched on, the SuperFreeze function ❄️ can be used to rapidly reduce the temperature in the **freezer section** to its lowest setting (depending on the ambient temperature). The refrigeration appliance will work at full power and lower the temperature. Select this function before freezing fresh food. Fresh food will be frozen quickly, so that the nutritional value, vitamin content, appearance, and taste are maintained.

When the SuperFreeze function ❄️ is switched on, the appliance may make more noise than usual.

SuperFreeze should be switched on approx. **6 hours before** placing food in the freezer section.

When freezing the **maximum amount of food**, the SuperFreeze function ❄️ should be switched on **24 hours beforehand**.

The SuperFreeze function ❄️ will switch itself off automatically after a maximum of 72 hours. The appliance will then run at normal power again. The exact amount of time will vary according to how much fresh food is placed in the freezer.

**Tip:** To save energy, you can switch the SuperFreeze function off yourself once food and drinks are sufficiently chilled.

You do not need to switch on the SuperFreeze function:

- When you place food that is already frozen in the freezer.
- If you are only freezing up to 4.4 lb (2 kg) of fresh food daily.

## Switching SuperFrost ❄️ on and off

- Touch the temperature display.
- Tap ❄️ to switch the SuperFrost function on and off again.

When the SuperFrost function is **switched on**, ❄️ will light up orange.

- Tap the temperature display to leave the Settings level.

# Selecting additional settings

## Explanation of the different settings

Only the settings that require further explanation are described below.

The door alarm and other warnings are automatically suppressed when you are in Settings mode .



### Party mode

The Party mode function  is recommended if you wish to freeze large amounts of fresh food quickly and if you need ice cubes.

**Tip:** Switch on the Party mode function  approx. 4 hours before placing food in the appliance.

When Party mode  is switched on, the following are switched on automatically:



- the SuperFrost function 
- the ice maker (ice cubes will be produced)

The Party mode function  will switch itself off automatically after approx. 24 hours. However, you can switch the Party mode function  off early at any time.

If there is a power outage, the Party mode function  is switched off.

### Switching the safety lock function / on

When the safety lock function is switched on, it protects the refrigeration appliance from being switched off or adjusted unintentionally by unauthorized persons, e.g., children.

- Tap .
- Swipe left or right until  is shown in the middle.

- Tap .

When the safety lock function is switched on,  will light up orange.

- Close the appliance door. Only then will the safety lock function  be active.

### Deactivating the safety lock function / temporarily

If you want to adjust the temperature, for example, you can deactivate the safety lock function temporarily:



- Touch the temperature display.
- Touch  for approx. 6 seconds.

The display switches to the temperature controls.

- Now select the required settings.

Closing the appliance door will reactivate the safety lock function .

### Switching the safety lock function / off completely

- Tap .
- Touch  for approx. 6 seconds.
- Swipe left or right until  is shown in the middle.

## Selecting additional settings

- Tap .

When the safety lock function is switched off,  will light up.

### Sabbath mode

The appliance features a Sabbath mode for the purposes of religious observance.

If Sabbath mode  is switched on, this will be indicated on the status display.

The display switches off after 3 seconds.

When Sabbath mode  is switched on, you cannot make any settings on your refrigeration appliance.

Ensure that the appliance door is properly closed, as visual and audible alarms are switched off.

The Sabbath mode function  will switch off automatically after approx. 120 hours.

When Sabbath mode  is switched on, the following are deactivated:

- the interior lighting when the appliance door is opened
- all audible and visual signals
- the temperature display

All other functions switched on previously remain activated.

 Health risk caused by decomposing food.

As power failures are not indicated while Sabbath mode  is active, food may be exposed to increased temperatures for a certain period of time. This will reduce the storage life of the food.

If there is a power failure during Sabbath mode , check the quality of the food.

### Switching Sabbath mode off

- Tap the black display.

 will appear on the display.

- Tap .

 lights up orange.

- Tap the  symbol again.

When Sabbath mode is switched off, the  symbol will light up white.

### Information on Sabbath mode

This product is certified by Star-K, an international institute for kosher certification.



You can find the Star-K certification version here.

# Selecting additional settings

---

## Changing the time before the door alarm is triggered

You can set how quickly the door alarm should sound after an appliance door has been opened.

- Tap .
- Swipe left or right until  is shown in the middle.
- Tap .
- Swipe left or right until the time you want between 30 seconds and 3 minutes 30 seconds is shown in the middle.
- Tap on the setting you want to confirm.

## Miele@home

Your refrigeration appliance is equipped with an integrated WiFi module.

Networking is deactivated at the factory.

To use this feature, you will need:

- a WiFi network
- the Miele app
- a Miele user account You can create a user account via the Miele app.

The Miele app will guide you as you connect your refrigeration appliance to your home WiFi network.

Once the refrigeration appliance is connected to your WiFi network, you can use the app to carry out the following activities, for example:

- Call up information on the operating status of your refrigeration appliance.
- Change the settings on your refrigeration appliance.

Connecting your refrigeration appliance to your WiFi network will increase energy consumption, even when the appliance is switched off.

Make sure that the signal of your WiFi network is sufficiently strong in the place where you want to set up your refrigeration appliance.

# Selecting additional settings

## Availability of the WiFi connection

The WiFi connection shares a frequency range with other appliances (including microwave ovens and remote control toys). This can cause sporadic or even complete connection failures. Therefore, the availability of featured functions cannot be guaranteed.

## Miele@home availability

The ability to use the Miele app depends on the availability of the Miele@home service in your country.

The Miele@home service is not available in every country.



For information about availability, please visit [www.miele.com](http://www.miele.com).

## Miele App

The Miele App is available to download free of charge from the Apple App Store® or from the Google Play Store™.



## Setting up Miele@home for the first time





- Tap .
- Swipe left or right until  is shown in the middle.
- Tap .
- Tap on the connection method you wish to use (app or WPS).

After you have successfully logged in,  will appear on the status display.

If a connection could not be created,  will appear.

- In this case, start the process again.

## Deactivating or activating the WiFi connection

- Tap .
- Swipe left or right until  is shown in the middle.
- Tap .
- Tap  to deactivate the WiFi connection.

 will appear on the display.

- Tap  to reactivate the WiFi connection.





- Tap  to exit the menu level.

When the WiFi connection is active,  will light up on the status display.

# Selecting additional settings

---

## Resetting the network configuration

- Tap .
- Swipe left or right until  is shown in the middle.
- Tap .
- Swipe right until  is shown in the middle.
- Tap .
- Tap OK.



All entered settings and values for Miele@home are reset to the default settings.

The WiFi connection has been deactivated.  will go out on the status display.

Reset the network configuration if you are disposing of or selling your refrigeration appliance, or if you are putting a used refrigeration appliance into operation. All personal data is removed from the refrigeration appliance. This will also ensure that a previous owner is no longer able to access the refrigeration appliance.

## Changing the volume of the alarms and audible signals /



You can change the volume of the alarms and audible signals (e.g., in the event of a door alarm or a fault message). Alternatively, you can switch the alarms and audible signals off if you find them annoying.

- Tap .
- Swipe left or right until  is shown in the middle.
- Tap .
- Swipe left or right until the volume you want is shown in the middle.
- Confirm the volume you want by tapping on the segment bar.

When the alarms and audible signals are switched off,  will appear.

## Adjusting the display brightness

You can adjust the display brightness to the lighting conditions in the room.

- Tap .
- Swipe left or right until  is shown in the middle.
- Tap .
- Swipe left or right until the brightness you want is shown in the middle.
- Confirm the brightness you want by tapping on the segment bar.







# Selecting additional settings

## Switching off Demo mode

Demo mode  allows the refrigeration appliance to be presented in the showroom without the cooling system being switched on. Do not activate this setting for domestic use.



If Demo mode has been switched on as a default setting,  will show on the status display.

- Tap .
- Tap .
- Swipe left or right until  is shown in the middle.
- Tap .

After Demo mode  has been switched off, the refrigeration appliance shuts down and must be switched on again.

## Resetting the settings to their default settings

All settings made on the refrigeration appliance will be reset to default settings (for settings; see “Guide to the appliance”).

- Tap .
- Swipe left or right until  is shown in the middle.
- Tap .

 will appear on the display.

- Touch OK.

The refrigeration appliance shuts down and must be switched on again.

## Information

Appliance data (model identifier and serial number) is shown on the display.

Keep this appliance data to hand; you will need it:

- When integrating the refrigeration appliance into your WiFi network (see “Selecting additional settings – Miele@home”).
- When reporting an appliance fault to Miele Customer Service (see “Service”).
- When retrieving information from the EPREL database (see “Service”).

# Temperature and door alarm

 Health risk caused by decomposing food.

If the temperature in the freezer remains above 0°F (-18°C) for a long time, the frozen food may start to defrost. This will reduce the storage life of the food.

Check whether the frozen food has started to defrost. If it has, use the food as soon as possible or cook it before freezing it again.

## Temperature alarm

The refrigeration appliance has been equipped with a warning system so that the temperature in the freezer section cannot rise unnoticed.

If the temperature becomes too warm,  will light up red in the temperature display.

An alarm will also sound until the cause of the alarm is rectified or the alarm is switched off.

The temperature the appliance is set at determines the temperature the appliance recognizes as being too warm.

The audible and visual signals may be activated in the following situations:

- You switch on the refrigeration appliance and the temperature in a temperature zone differs greatly from the set temperature.
- A lot of warm room air enters the freezer section when you are rearranging or taking out frozen food.
- You are freezing large amounts of food at once.
- You are freezing warm food.
- There was a power failure.
- The refrigeration appliance has a fault.

Before you switch the temperature alarm off, you must determine the cause and rectify it.

If the alarm disturbs you, it can be turned off early.

■ Tap .

The alarm message is confirmed:  goes out and the alarm stops.

The start screen appears in the display: The warmest temperature recorded in the refrigeration appliance will flash for about 1 minute in the display. Then the temperature display will change to the current temperature in the refrigeration appliance.

## Door alarm

The refrigeration appliance is equipped with a warning system to avoid increased energy consumption and food becoming warm if the appliance door is left open.

If the appliance door is left open for a longer period of time,  will light up yellow in the temperature display. An alarm will also sound.

You can change the time before the door alarm is triggered. However, the door alarm can also be turned off (see “Selecting additional settings”).

The alarm will stop and  will go out on the display as soon as the door is closed.

### Turning the door alarm off early

If the alarm disturbs you, it can be turned off early.

■ Touch  in the display.

The alarm will stop and the  symbol will go out.

If the appliance door is not closed, the alarm will sound again after 3 minutes.

# Freezing and storing food

---

## What happens when you freeze fresh food?

 Health risk caused by decomposing food.

If the temperature in the freezer remains above 0°F (-18°C) for a long time, the frozen food may start to defrost. This will reduce the storage life of the food.

Check whether the frozen food has started to defrost. If it has, use the food as soon as possible or cook it before freezing it again.

Fresh food should be frozen as quickly as possible so that the nutritional value of the food, its vitamin content, appearance, and flavor are maintained.

If food is frozen quickly, the cells have less time to lose moisture, so they shrink significantly less. As there is not so much moisture loss, it is easier for the food to reabsorb it during the defrosting process, and very little water collects around the defrosted food.

## Maximum freezing capacity

To ensure that fresh food placed in the freezer freezes through to the core as quickly as possible, the maximum freezing capacity must not be exceeded. The maximum freezing capacity for freezing within a 24-hour period is given on the data plate: “Freezing capacity ... lbs/24 hrs”.

## Storing frozen food

When buying frozen food to store in your freezer, make sure to check:

- that the packaging is not damaged
- the expiration date
- that the temperature at which the frozen food is being stored in the shop is 0°F (-18°C) or colder
- Where possible, transport frozen food in an insulated bag and then store it quickly in the refrigeration appliance.

# Freezing and storing food

## Home freezing

### Before placing food in the freezer

- When freezing more than 4.4 lb (2 kg) of fresh food, switch on the SuperFreeze function ❄ for 6 hours before placing the food in the freezer.
- When freezing even larger amounts of food, switch on the SuperFreeze function ❄ for 24 hours before placing the food in the freezer.

This helps frozen food which is already stored in the freezer to stay frozen.

- Only freeze food that is fresh and in good condition.

Please note that some food is not suitable for freezing. These include, for example, vegetables that are usually eaten raw, such as lettuce or radishes.

**Tip:** To retain color, taste, aroma, and vitamin C, vegetables should be blanched before they are frozen. To do so, place them portion by portion into boiling water for 2–3 minutes. Then, remove and plunge the vegetables into ice-cold water to cool quickly. Leave the vegetables to drain.

### Packaging food for freezing

- Freeze food in portions.

**Tip:** Use suitable packaging to avoid freezer burn (such as freezer containers).

- Expel as much air as possible from the packaging and close it tightly.
- Label the packaging with the contents and the date of freezing.

### Placing food in the freezer

 Risk of damage due to heavy loads.

Loading food which is too heavy can cause damage to the freezer drawers/glass shelves.

Do not exceed the relevant maximum load:

Freezer drawer = 26 lb (12 kg)

Glass shelf = 77 lb (35 kg)

Unfrozen food should not touch frozen food as this will cause the frozen food to begin to thaw.

- To prevent food sticking together when frozen, make sure that the packaging and containers are dry.

To ensure that food freezes through to the core quickly, do not exceed the following packaging and container sizes:

- fruit and vegetables:  
max. 2.2 lb (1 kg)
- meat: max. 5.5 lb (2.5 kg)

### – Freezing small amounts of food

Place the food in the upper freezer drawers.

# Freezing and storing food

- Place the food flat in the bottom of the **upper** freezer drawers so that it freezes through to the core as quickly as possible.

## – VarioRoom: freezing the maximum amount of food (see data plate)

If the ventilation slots are obstructed, the cooling performance will decrease and energy consumption will increase.

When placing food in the freezer, make sure that the ventilation slots are not blocked.

**Tip:** You can expand the space available in the freezer section. If you wish to freeze large items, such as turkey or game, you can remove the glass shelves between the freezer drawers.

- Remove the upper freezer drawers.
- Place the food flat on the upper glass shelves so that it freezes through to the middle as quickly as possible.

### Once the food has frozen:

- Switch the SuperFrost function ❄ off.
- Place the frozen food in the freezer drawers and push them back in.

## Storage time for frozen food

Food group	Storage time (Months)
Ice cream	2 to 6
Bread, baked goods	2 to 6
Cheese	2 to 4
Fish, oily	1 to 2
Fish, lean	1 to 5
Sausage, ham	1 to 3
Game, pork	1 to 12
Poultry, beef	2 to 10
Vegetables, fruit	6 to 18
Herbs	6 to 10

The storage times given are guidelines only.

Where the storage time given on the packaging differs, follow the advice on the packaging.

By keeping the freezer section at a constant temperature of 0°F (-18°C) and taking appropriate hygiene measures you can maximize the storage life of your food and avoid food waste.

## Cooling drinks quickly

When chilling drinks in the freezer, make sure that bottles are not left in for **more than one hour**. Otherwise they could burst.

## Making ice cubes

Check and pay attention to the following before switching the ice maker on:

- The ice maker must be clean.
- The refrigeration appliance must be switched on.
- Ice cubes can only be made when the ice cube drawer is completely closed.
- There is a clip-on container at the top of the ice cube drawer. If you ever need a larger quantity of ice cubes, you can simply remove the clip-on container. The ice maker then automatically produces ice cubes until the maximum fill level in the ice cube drawer is reached.

 Risk to health due to contaminated water.

Bacteria can develop in water which has been sitting in the water-supply lines for too long. This poses a risk to your health.

Throw away the first 3 batches of ice cubes made after the ice-cube maker is started up, as the water will have been used for the initial rinsing of the water-supply line.

This applies to the initial commissioning as well as when using the ice-cube maker again after it has been switched off for an extended period of time (more than 5 days).

When using the appliance for the first time, it can take up to 24 hours for the first ice cubes to drop out of the ice maker and collect in the drawer.

After the ice maker has been turned off and on again, it can take up to 6 hours for this process to be completed.



Only make normal domestic quantities of ice cubes with the ice maker.

The ice maker can make up to approx. 2.6 lb (1.2 kg) of ice cubes in 24 hours.

The amount of ice cubes made by the appliance depends on the temperature in the freezer section. **The lower the temperature, the more ice cubes are produced in a certain period of time.**

# Making ice cubes

## Switching the ice maker on and off

- Tap .
- Swipe left or right until  is shown in the middle.
- Tap .

 will light up orange when the ice maker is switched on.

Once the freezer section has cooled down to its set temperature, the ice maker will fill with water.

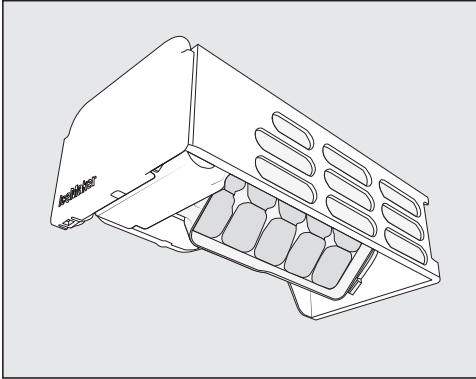

As soon as ice cubes are produced, they will empty automatically from the integrated ice cube tray and into the clip-on container. The clip-on container can be removed if required.

Ice cube production is halted automatically when the clip-on container or the ice cube drawer is full. The drawer will not fill up to the top edge.

**Tip:** Increase the fill volume of ice cubes by spreading the ice cubes out evenly from time to time.

**Tip:** Empty the clip-on container or the ice cube drawer at regular intervals, or if you have not produced any ice for more than a week. This will ensure that you always have fresh ice and the ice cubes will not form a clump.

The ice maker can be turned off independently of the freezer section if you do not want to make any ice cubes.

If the ice maker is switched off, food can be placed in the ice cube drawer and frozen.

- Push the ice cube drawer all the way back in when you stop ice cube production.



 **WARNING! DANGER** of injury and damage!

Do not use any mechanical or other types of aids which are not recommended by the manufacturer to accelerate the defrosting process.

The appliance is equipped with a “NoFrost” system. The freezer defrosts automatically.

The moisture generated in the appliance collects on the condenser and is automatically defrosted and evaporates periodically.

This automatic defrosting system enables the refrigeration appliance to remain permanently ice-free. However, the food stored in the freezer will not defrost.

## Cleaning and care

---

 **WARNING! DANGER** of electric shock!

Unplug the appliance or trip the circuit breaker.

 **WARNING! Fire hazard!**

Do not damage the coolant pipework.

The data plate located inside the interior cabinet of the refrigeration appliance must not be removed. It contains information which is required in the event of a service call.

Do not let water get into the electronic or the lighting.

 Risk of damage due to moisture penetration.

The steam from a steam cleaner can damage plastic and electrical components.

Do not use a steam cleaner to clean the refrigeration appliance.

### Cleaning agents

Cleaning and care products used in the interior cabinet of the refrigeration appliance must be food safe.

To avoid damaging the surfaces of your appliance, **do not** use the following:

- cleaning agents containing soda, ammonia, acids, or chloride
- cleaning agents containing limescale remover
- abrasive cleaning agents, such as scouring powder, scouring liquid, or pumice stones
- cleaning agents containing solvents
- stainless steel cleaners
- dishwasher cleaning agents
- oven sprays
- glass cleaners
- hard, abrasive sponges and brushes, such as pot scrubbers
- eraser sponges
- sharp metal scrapers

We recommend using a clean sponge, lukewarm water with a little liquid dish soap to clean the surfaces of the appliance.

### Preparing the refrigeration appliance for cleaning

- Turn the appliance off.
- ⏻ appears in the display and the cooling system is switched off.
- Take any food out of the appliance and store it in a cool place.
- Take out any removable accessories for cleaning (see “Removing and dismantling accessories for cleaning”).

### Cleaning the interior of the appliance

Clean the appliance regularly, or at least once a month.

If soiling is left on for any length of time, it may become impossible to remove under certain circumstances. Surfaces may become discolored or damaged. It is therefore best to remove any soiling immediately.

- Clean the **interior** with a clean sponge, lukewarm water, and a little liquid dish soap.
- After cleaning, wipe with clean water and dry with a soft cloth.
- Leave the door open to air the refrigeration appliance sufficiently for a short while and to prevent odor build-up.

# Cleaning and care

---

## Cleaning accessories by hand or in the dishwasher

The following components must be cleaned **by hand** only:

- All drawers
- Pull-out shelf with Ice&PizzaBox
- Telescopic runners and protective trim (on the glass shelves)
- The clip-on container
- The ice cube scoop

The following components are **dishwasher-safe**:

 Risk of damage due to high dishwasher temperatures.

Parts of the refrigeration appliance may become unusable, e.g., deform, if they are washed in the dishwasher at more than 130°F (55°C).

For dishwasher-safe components, always select dishwasher programs with a maximum temperature of 130°F (55°C).

Contact with natural dyes from carrots, tomatoes, and ketchup, etc., may discolor the plastic parts in the dishwasher. This discoloration does not affect the stability of the parts.

- The glass shelves

## Removing, dismantling, and cleaning accessories

### Removing the top drawer and glass shelf

- Pull the drawer out as far as it will go.

- Tilt the drawer slightly upward and remove the drawer upward at an angle.
- Pull out the glass shelf together with the guide rails.
- Pull the guide rails off to the side.
- After cleaning, reattach the guide rails to the glass shelf.

### Reinserting the top drawer

- Insert the glass shelf together with the guide rails in the freezer section.
- Place the drawer on the guide rails from an angle at the top and push the drawer all the way in.

## Removing the drawers and glass shelves on telescopic runners

The magnet on the drawer is important for the proper functioning of the ice maker.  
Do not remove the magnet.

- Pull out the drawer as far as it will go and then lift it up and out.

Push the telescopic runners back in again to avoid damaging them.

- Pull the glass shelf and telescopic runners out.

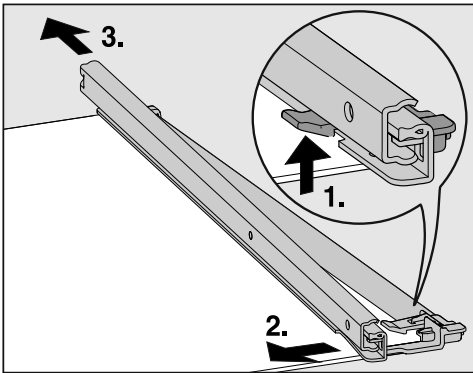

- To remove the telescopic runners:
  1. Push the catch upward.
  2. Push the telescopic runner to the side.
  3. Then pull the telescopic runner off to the rear.
- Pull off the protective trim at the front and back of the shelf.
- After cleaning the shelf, reattach the protective trim.

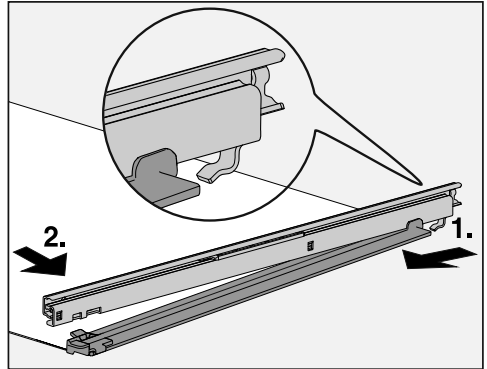

- To attach the telescopic runners to the shelf:
  1. Hook the telescopic runner on at the rear.
  2. Then clip the catch into position at the front.

## Reinserting the drawer

- Insert the glass shelf together with the telescopic runners in the freezer section.
- Slide the drawer onto the fully retracted telescopic runners.

## Cleaning and care

### Removing the Ice&PizzaBox with pull-out shelf

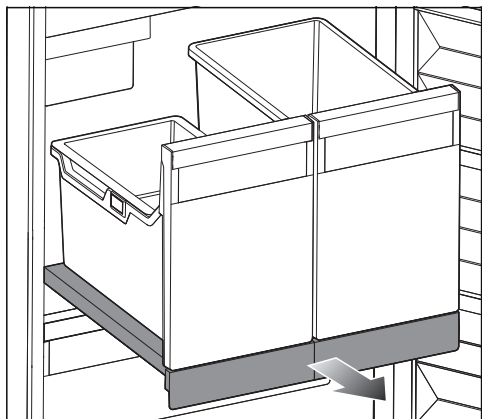

- Pull out the pull-out shelf completely.
- Remove the ice cube drawer with the clip-on container and the PizzaBox by lifting them slightly at the front.
- Empty the clip-on container, the ice cube drawer, and the PizzaBox.

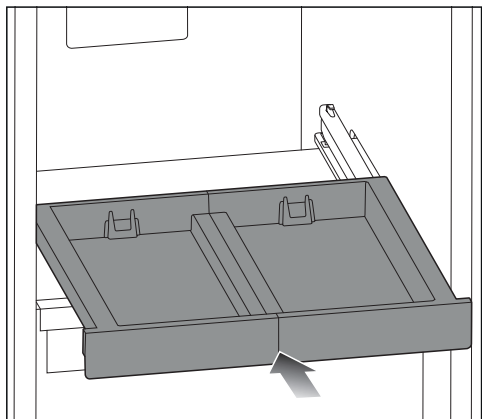

- Push the pull-out shelf all the way in.

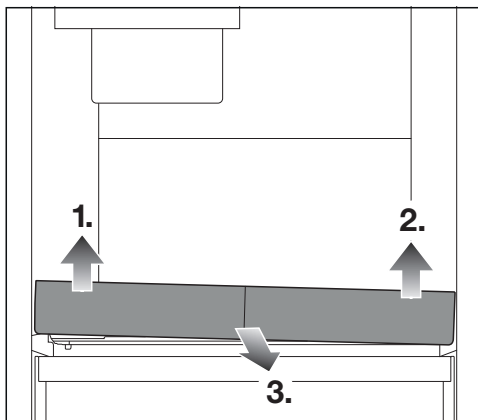

- Lift the pull-out shelf first at the front left 1.), then at the front right 2.) so that it comes loose from its fastening.

Now you can remove the pull-out shelf to the front 3.).

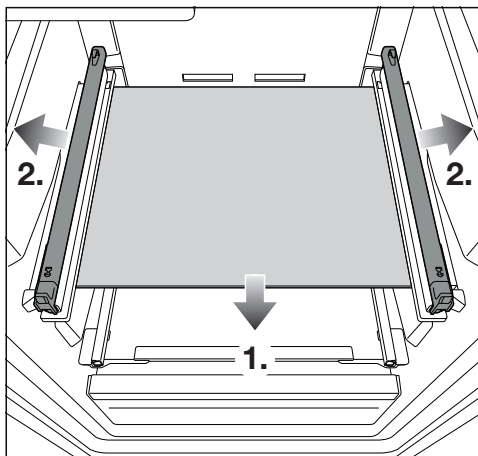

- Remove the glass shelf 1.) and then pull off the telescopic runners to the side 2.).

## Reinserting the pull-out shelf with Ice&PizzaBox

- Attach the telescopic runners on each side of the glass shelf.
- Insert the glass shelf into the freezer section.

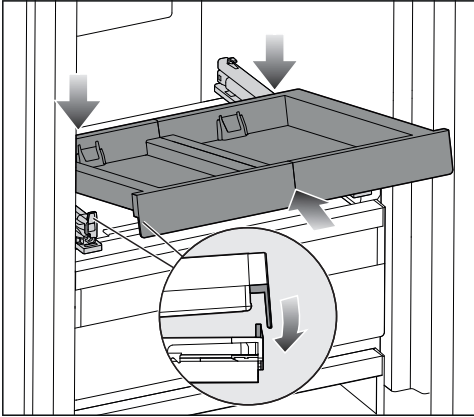

- Insert the pull-out shelf at an angle behind the front retainer.
- Push in the pull-out shelf at an angle.

The stop must be positioned behind the retainer on both sides.

- Set the pull-out shelf down at the front.

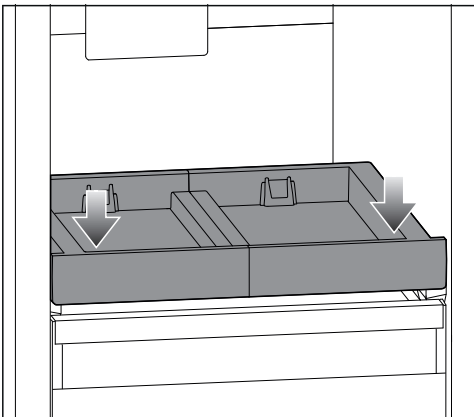

- Press the pull-out shelf down slightly at the front so that it audibly engages.
- Pull out the pull-out shelf while supporting it lightly with your hand.
- Place the ice cube drawer and the PizzaBox on the pull-out shelf.

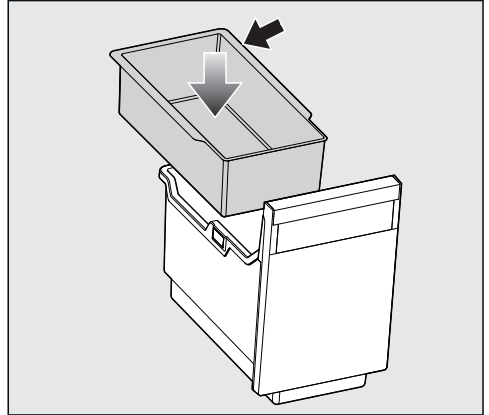

- Place the clip-on container in the ice cube drawer with the raised edge at the back.
- Push the pull-out shelf back in all the way.

# Cleaning and care

## Cleaning the ice-cube tray

The ice-cube tray **cannot be removed** and therefore has to be moved into the cleaning position.

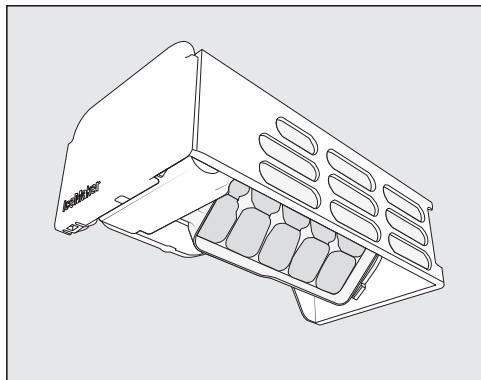

Clean the ice-cube tray:

- Before switching off the ice-cube maker for a long period of time.
- Regularly, to remove ice and water residues.

### Selecting the cleaning position ④ for the ice-cube tray

Before selecting the cleaning position for the ice-cube tray, check the following:

- The ice-cube maker is switched on.
- The ice-cube drawer is empty and in position.
- Tap ⚙️.
- Swipe left or right until ④ is shown in the middle.
- Tap ④.

It will take some time to move the ice-cube tray into the cleaning position.

If the ice-cube drawer is full, ⓧ will appear on the display. The process will stop and the ice-cube tray will return to its original position.

- Empty the ice-cube drawer and start the process again.

Once the ice-cube tray has stopped moving, the ✓ symbol will appear on the display.

- To leave this Settings level, tap ↩️.
- Remove the ice-cube drawer.
- Clean the ice-cube tray and the ice-cube drawer with lukewarm water and liquid dish soap. Wipe thoroughly with clean water and dry with a cloth.
- Insert the ice-cube drawer back into the appliance.
- After cleaning, tap ✓.

You will hear the ice-cube tray return to its original position.



## Cleaning the door seal

 Risk of damage as a result of incorrect cleaning.

If you treat the door seal with oil or grease, it can become porous.

Do not use oil or grease on the door seal.

- The door seals should be cleaned regularly with clean water, and then wiped dry with a soft cloth.

## Cleaning the ventilation gaps

A build-up of dust will increase the energy consumption of the appliance.

- The ventilation gaps should be cleaned on a regular basis with a brush or vacuum cleaner (you could use a Miele Vacuum Cleaner dust brush, for example).

## After cleaning

- Place all shelves and accessories back in the appliance.
- Switch the refrigeration appliance back on, if necessary.

The refrigeration appliance will start cooling again.

- Switch the SuperFrost ❄️ function on for a while so that the freezer section can cool down quickly.
- Once the temperature in the freezer section is cold enough, you can place the food in the freezer drawers and return the drawers to the freezer.
- Switch off the SuperFrost ❄️ function as soon as the temperature in the freezer section is a constant 0°F (-18°C) or colder.
- Close the appliance door.



## Frequently asked questions

Many malfunctions and faults that can occur in daily operation can be easily remedied. You can save time and money in many cases, as you do not need to contact Miele Customer Service.

Information to help you rectify faults yourself can be found at [www.miele.com/service](http://www.miele.com/service).

The following tables are designed to help you to find the cause of a malfunction or a fault and to resolve it.

To prevent cold from escaping, open the appliance doors as little as possible until the fault has been corrected.

Problem	Possible cause and solution
<b>The refrigeration appliance is not getting cold and the interior lighting does not come on when the appliance door is opened.</b>	The refrigeration appliance is not switched on and the  symbol is lit up on the display. ■ Turn the refrigeration appliance on.
	The electrical plug is not properly plugged into the socket. ■ Insert the electrical plug into the socket. If the refrigeration appliance is switched off,  will appear on the display.
	The fuse has tripped. There could be a fault with the appliance, the household electrical wiring, or another appliance. ■ Contact a qualified electrician or Miele Customer Service.
<b>The compressor runs continuously.</b>	Not a fault. To save energy, the compressor runs at a lower speed when less cooling is required. This increases the compressor run time.
<b>The compressor is turning on more frequently and for longer periods of time; the temperature in the refrigeration appliance is too low.</b>	The ventilation gaps are obstructed or dusty. ■ Do not block the ventilation gaps. ■ Clean the ventilation gaps on a regular basis to remove any dust.
	The appliance door has been opened too frequently, or a large amount of fresh food has been placed inside or frozen at the same time. ■ Only open the appliance door when necessary and for as short a time as possible.





## Frequently asked questions

Problem	Possible cause and solution
	<p>After a while, the temperature will return to normal by itself.</p>
	<p>The appliance door is not properly closed. A thick layer of ice may have already formed in the freezer section.</p> <ul style="list-style-type: none"> <li>■ Close the appliance door.</li> </ul> <p>After a while, the temperature will return to normal by itself.</p> <p>If a thick layer of ice has already formed, this will affect cooling and increase energy consumption.</p> <ul style="list-style-type: none"> <li>■ Defrost the appliance and clean it.</li> </ul>
	<p>The ambient temperature is too high. The higher the ambient temperature, the longer the compressor runs.</p> <ul style="list-style-type: none"> <li>■ See the information in the section on “Installation – Installation location”.</li> </ul>
	<p>The appliance was not properly installed in the niche.</p> <ul style="list-style-type: none"> <li>■ Install the refrigeration appliance in the niche as described in the installation instructions supplied with it.</li> </ul>
	<p>The temperature setting in the refrigeration appliance is too low.</p> <ul style="list-style-type: none"> <li>■ Correct the temperature setting.</li> </ul>
	<p>A large amount of food was put in for freezing all at once.</p> <ul style="list-style-type: none"> <li>■ See the information in the section on “Freezing and storing food”.</li> </ul>
	<p>The SuperFrost function ❄️ is still switched on.</p> <ul style="list-style-type: none"> <li>■ Switch off the SuperFrost function ❄️ earlier to save energy.</li> </ul>

## Frequently asked questions















Problem	Possible cause and solution
<p><b>The compressor comes on less and less often and for shorter periods of time. The temperature in the appliance rises.</b></p>	<p>This is not a fault. The temperature setting is too high.</p> <ul style="list-style-type: none"> <li>■ Correct the temperature setting.</li> <li>■ Check the temperature again after 24 hours.</li> </ul> <p>The food begins to thaw. The ambient temperature is too low for this appliance. If the ambient temperature is too low, the compressor will run less frequently. This may cause the freezer to become too warm.</p> <ul style="list-style-type: none"> <li>■ See the information in the section on “Installation – Installation location”.</li> <li>■ Increase the ambient temperature.</li> </ul>
<p><b>Ice or condensation has built up inside the refrigeration appliance. The appliance door may not close correctly.</b></p>	<p>The door seal has come out of its groove.</p> <ul style="list-style-type: none"> <li>■ Check that the door seal is correctly positioned in the groove.</li> </ul> <p>The door seal is damaged.</p> <ul style="list-style-type: none"> <li>■ Check whether the door seal is damaged.</li> </ul>
<p><b>The door seal is damaged or needs to be replaced.</b></p>	<p>No tools are required to change the door seal.</p> <ul style="list-style-type: none"> <li>■ Change the door seal. A replacement is available from Technical Service.</li> </ul>

### Other problems







Problem	Possible cause and solution
<b>Food has frozen together or to the wall.</b>	<p>The food packaging was not dry when loaded in the freezer.</p> <ul style="list-style-type: none"><li>■ Use a blunt instrument (such as a spoon handle) to carefully pry them apart.</li></ul>
<b>An alarm does not sound even though the appliance door has been open for a long time.</b>	<p>This is not a fault. The alarm has been switched off in Settings mode. If you want to switch the acoustic alarm back on again:</p> <ul style="list-style-type: none"><li>■ Tap .</li><li>■ Swipe left or right until  is shown in the middle.</li><li>■ Tap .</li><li>■ Swipe left or right until the volume you want is shown in the middle.</li><li>■ Confirm the volume you want by tapping on the segment bar.</li></ul> <p>When the alarms and audible signals are switched on,  will appear.</p>

# Frequently asked questions



## Messages in the display

Message	Possible cause and solution
 lights up on the status display, the refrigeration appliance does not get cold even though the controls and the interior lighting are working.	Demo mode has been activated. <ul style="list-style-type: none"><li>■ Tap .</li><li>■ Tap .</li><li>■ Swipe left or right until  is shown in the middle.</li><li>■ Tap .</li></ul> After Demo mode  has been switched off, the refrigeration appliance shuts down and must be switched on again.
Nothing is visible on the display. The display is completely blank.	Sabbath mode  is switched on: the interior lighting is switched off and the appliance is cooling down. <ul style="list-style-type: none"><li>■ Tap on the black display.</li></ul>  will appear on the display. <ul style="list-style-type: none"><li>■ Tap .</li></ul>  lights up orange. When Sabbath mode is switched off, the  symbol will light up white.
 is lit up on the display and the appliance cannot be used.	The safety lock function has been activated. <ul style="list-style-type: none"><li>■ Unlock the refrigeration appliance temporarily or switch the safety lock function off completely (see “Selecting additional settings – Deactivating the safety lock function /  temporarily/switching off completely”).</li></ul>

## Frequently asked questions



Message	Possible cause and solution
<p> <b>lights up yellow in the display and an alarm also sounds.</b></p>	<p>The ice cube drawer is not in the refrigeration appliance. An audible signal sounds after closing the appliance door.</p> <ul style="list-style-type: none"> <li>■ Tap  on the display.</li> </ul> <p>The alarm message is confirmed and the audible signal stops.</p> <p>The current temperature will appear in the display again.</p> <ul style="list-style-type: none"> <li>■ Replace the drawer correctly in the refrigeration appliance or switch the ice maker off.</li> </ul> <hr/> <p>The plumbed water connection was not installed.</p> <ul style="list-style-type: none"> <li>■ Make sure that the plumbed water connection was installed correctly.</li> </ul> <hr/> <p>The water supply is turned off.</p> <ul style="list-style-type: none"> <li>■ Open the shut-off valve.</li> </ul> <hr/> <p>There is a kink in the hose.</p> <ul style="list-style-type: none"> <li>■ Check the hose; if it is faulty, it must only be replaced by an original Miele spare part.</li> </ul> <hr/> <p>The water connection pressure is too low.</p> <ul style="list-style-type: none"> <li>■ Check that the water connection pressure is between 21.7 and 90 psi (1.5 and 6.2 bar).</li> </ul>
<p> <b>lights up yellow in the display and an audible signal sounds.</b></p>	<p>The drawer for the ice-cube maker is full.</p> <ul style="list-style-type: none"> <li>■ Remove the drawer and empty it.</li> </ul>
<p> <b>is lit up yellow in the temperature display and an alarm is also sounding.</b></p>	<p>The door alarm has been activated.</p> <ul style="list-style-type: none"> <li>■ Touch and hold  in the display for a few seconds.</li> </ul> <p>The alarm will stop and the  symbol will go out.</p> <ul style="list-style-type: none"> <li>■ Close the appliance door.</li> </ul>

## Frequently asked questions









Message	Possible cause and solution
<p> is lit up red in the temperature display and an alarm is also sounding.</p>	<p>The temperature alarm has been activated; the temperature in the freezer section has risen higher or fallen lower than the temperature set.</p> <p>Possible reasons for this include:</p> <ul style="list-style-type: none"><li>– The appliance door has been opened too frequently.</li><li>– A large quantity of fresh food has been placed in the freezer without switching on the Super-Frost function.</li><li>– A prolonged power failure has occurred.</li><li>– The refrigeration appliance has a fault.</li></ul> <p>■ Tap .</p> <p>The alarm message is confirmed:  goes out and the alarm stops.</p> <p>The warmest temperature recorded in the refrigeration appliance will flash for about 1 minute in the display. Then the temperature display will change to the current temperature.</p> <p>You can exit from the flashing temperature display early:</p> <p>■ Touch the temperature display.</p> <p>The warmest temperature display will disappear. The display will then revert to showing the current temperature in the freezer section.</p> <p>■ Rectify the cause of the alarm.</p> <p>■ Depending on the temperature displayed, you should check whether food in the freezer has started to thaw or has defrosted. If it has, cook it before freezing it again.</p>



## Frequently asked questions

Message	Possible cause and solution
<p> <b>lights up red in the display and an alarm also sounds.</b></p>	<p>There is a power failure: The temperature in the appliance over the last few days or hours has risen too high because of a power failure or interruption to the power supply.</p> <ul style="list-style-type: none"><li>■ Tap .</li></ul> <p>The fault message is confirmed:  goes out and the alarm stops.</p> <p>The warmest temperature recorded in the refrigeration appliance will flash for about 1 minute in the display. Then the temperature display will change to the current temperature.</p> <p>You can exit from the flashing temperature display early:</p> <ul style="list-style-type: none"><li>■ Touch the temperature display.</li></ul> <p>The warmest temperature display will disappear. The display will then revert to showing the current temperature. The appliance will go back to the last temperature setting when the power is restored.</p> <ul style="list-style-type: none"><li>■ Rectify the cause of the alarm.</li><li>■ Depending on the temperature displayed, you should check whether food in the freezer has started to thaw or has defrosted. If it has, cook it before freezing it again.</li></ul>

## Frequently asked questions

Message	Possible cause and solution
<p> <b>lights up red in the display and a fault code F with numbers may appear. An alarm will also sound.</b></p>	<p>There is a fault.</p> <ul style="list-style-type: none"> <li>■ Tap  on the display to switch the alarm off.</li> <li>■ Contact Miele Customer Service.</li> </ul> <p>To report the fault, you need the fault code and also the model identifier and serial number of your refrigeration appliance. You can access this information on the display.</p> <ul style="list-style-type: none"> <li>■ To do this, touch  on the display.</li> </ul> <p>The appliance data required will be shown on the display.</p> <p>Confirm with <i>OK</i> to exit the information display and the fault code will be shown again on the display.</p> <p>The refrigeration appliance can be switched off directly from the fault-message display.</p> <hr/> <p>There is an appliance fault: this display always has priority over any settings which have just been selected.</p> <p>An appliance fault has priority over any current door and/or temperature alarms displayed.</p>
<p>  <b>lights up red in the display and an alarm also sounds.</b></p>	<p>There is a fault with the ice-cube maker.</p> <ul style="list-style-type: none"> <li>■ Tap   on the display to switch the alarm off.</li> <li>■ Contact Miele Customer Service.</li> </ul> <p>The ice-cube maker can also be switched off in Settings mode .</p>

## Frequently asked questions

### Problems with the ice cube maker

Problem	Possible cause and solution
<b>You cannot turn the ice cube maker on.</b>	The appliance is not connected to the power supply or is not switched on. ■ Reconnect to the power supply and switch the appliance back on.
<b>The ice maker is not producing any ice cubes.</b>	The refrigeration appliance or ice maker is not switched on. ■ Switch the refrigeration appliance and the ice maker on.
	The water supply has not been turned on or has not been vented. ■ Turn on the water supply. ■ Check that the water supply has been vented.
	The ice maker drawer is not closed properly. ■ Push the drawer all the way in.
	The appliance door has been opened too frequently, causing the compressor to turn on more often and the ice maker has iced up. ■ Only open the appliance door when necessary and for as short a time as possible.
	The temperature in the freezer section is too high. ■ Select a lower temperature.
	The water connection pressure is too low. ■ Check that the water connection pressure is between 21.7 and 90 psi (1.5 and 6.2 bar).
	<b>Remember that it can take up to 24 hours for the production of ice cubes to commence.</b>







## Frequently asked questions

Problem	Possible cause and solution
<b>The ice cubes have an unpleasant odor or flavor.</b>	<p>The ice-cube maker is in constant use and needs to be cleaned regularly.</p> <ul style="list-style-type: none"><li>■ Rinse the ice-cube maker and water-intake pipe regularly. The first three batches of ice cubes should be thrown away and not consumed.</li></ul>
	<p>The ice-cube maker is rarely used. If you do not use it very often, ice cubes that are stored for a long period can absorb the taste and smell of other items.</p> <ul style="list-style-type: none"><li>■ Empty the ice-cube drawer if you are not going to use the ice-cube maker for a long period of time.</li><li>■ Rinse the ice-cube maker and water-intake pipe regularly. The first three batches of ice cubes should be thrown away and not consumed.</li></ul>
	<p>There are unsealed food packages in the freezer section. Ice can absorb the taste and smell of unsealed food.</p> <ul style="list-style-type: none"><li>■ Store only sealed food in the freezer section.</li></ul>
	<p>The ice-cube drawer is dirty.</p> <ul style="list-style-type: none"><li>■ If necessary, clean the ice-cube drawer.</li></ul>

## The interior lighting is not working

 Risk of electric shock due to exposed, live electrical components. When removing the lighting cover, there is a risk of coming into contact with live electrical components. Do not remove the lighting cover. The LED lighting may only be repaired or replaced by Customer Service.

 Risk of injury from LED lighting. This lighting corresponds to risk group RG 2. If the cover is defective, there is a risk of eye injury. If the lighting cover is defective, do not look from a close range directly into the lighting with optical instruments (e.g., magnifying glass or similar).

Problem	Possible cause and solution
<p><b>The interior lighting is not working.</b></p>	<p>The refrigeration appliance has not been turned on.</p> <ul style="list-style-type: none"> <li>■ Turn the refrigeration appliance on.</li> </ul>
	<p>Sabbath mode  is switched on: the display is dark and the refrigeration appliance is cooling.</p> <ul style="list-style-type: none"> <li>■ Tap on the black display.</li> </ul> <p> will appear on the display.</p> <ul style="list-style-type: none"> <li>■ Tap .</li> </ul> <p> lights up orange.</p> <ul style="list-style-type: none"> <li>■ Tap on the  symbol in Settings mode .</li> </ul> <p>When Sabbath mode is switched off, the  symbol will light up white.</p>
	<p>To avoid overheating, the interior lighting switches itself off automatically after approximately 15 minutes if the appliance door is left open. If this is not the cause, there is a fault.</p> <ul style="list-style-type: none"> <li>■ Contact Miele Customer Service.</li> </ul>

## Causes of noises

The refrigeration appliance is producing various noises during operation. If the cooling performance is low, the refrigeration appliance will conserve energy but operate for longer. The volume will be lower. Food will be chilled faster if the cooling performance is high. The volume will be higher.

Normal noises	Cause
<b>Brrrrr...</b>	A humming noise is made by the motor (compressor). This noise can get louder for brief periods when the motor switches on.
<b>Blub, blub...</b>	A gurgling noise can be heard when the coolant circulates through the pipes.
<b>Click...</b>	Clicking sounds occur whenever the thermostat switches the motor on or off.
<b>Sssrrrrr...</b>	You can sometimes just hear the sound of the fan inside the appliance.
<b>Crack...</b>	A cracking sound can be heard when materials expand inside the appliance.

Please bear in mind that a certain amount of noise is unavoidable (from the compressor and the coolant circulating through the system).

Noises	Cause and solution
<b>Rattling, clinking</b>	The appliance is uneven. Realign the appliance using a level by raising or lowering the adjustable feet underneath the refrigeration appliance. For niches of 55" (140 cm) and more: place the stabilizing rods supplied underneath the appliance base.
	Drawers, baskets, or shelves are jiggling or are stuck. Check all removable parts and reinsert them correctly if required.
	Bottles or containers are touching each other. Separate them a little.

Information to help you rectify faults yourself and about Miele spare parts can be found at [www.miele.com/service](http://www.miele.com/service).

## Contact in the event of a fault

In the event of a fault which you cannot remedy yourself, please contact your Miele dealer or Miele Customer Service.

You can book a Miele Service Call online at [www.miele.com/service](http://www.miele.com/service).

Contact information for Miele Customer Service can be found at the end of this document.

Please quote the model identifier and serial number of your appliance (SN) when contacting Miele Customer Service. Both pieces of information can be found on the data plate.

You will find the data plate inside your appliance.

## Displaying appliance information

This can be found in Settings mode under Information **i** (see “Selecting additional settings”) or on the data plate inside the refrigeration appliance.

## Appliance warranty and product registration

You can register your product and/or view the manufacturer’s warranty terms and conditions for Miele appliances and vacuum cleaners at [www.mieleusa.com](http://www.mieleusa.com).

## Copyrights and licenses

---

For the purpose of operating and controlling the communication module, Miele uses proprietary or third-party software that is not covered by open source licensing terms. This software/these software components are protected by copyright. The copyrights held by Miele and third parties must be respected.

In addition, the integrated communication module contains software components which are distributed under open source licensing terms. You can access these open source components along with the associated copyright notices, copies of the valid licensing terms, and any additional information locally via IP using a web browser ([http\[s\]://<ip address>/Licenses](http[s]://<ip address>/Licenses)). The liability and warranty arrangements for the open source licenses displayed in this location only apply in relation to the respective rights holders.







**Please have the model and serial number  
of your appliance available when  
contacting Customer Service.**

---

## **U.S.A.**

**Miele, Inc.**

### **National Headquarters**

9 Independence Way  
Princeton, NJ 08540  
[www.mieleusa.com](http://www.mieleusa.com)

### **Customer Support**

Phone: 888-99-MIELE (64353)  
[info@mieleusa.com](mailto:info@mieleusa.com)

### **International Headquarters**

Miele & Cie. KG  
Carl-Miele-Straße 29  
33332 Gütersloh  
Germany

## **Canada**

**Importer  
Miele Limited**

### **Headquarters and Miele Centre**

161 Four Valley Drive  
Vaughan, ON L4K 4V8  
[www.miele.ca](http://www.miele.ca)

### **Customer Care Centre**

Phone: 1-800-565-6435  
905-532-2272  
[customercare@miele.ca](mailto:customercare@miele.ca)

FNS 7794 E

en - US, CA

M.-Nr. 11 930 810 / 02