

Operating and Installation Instructions Speed Oven

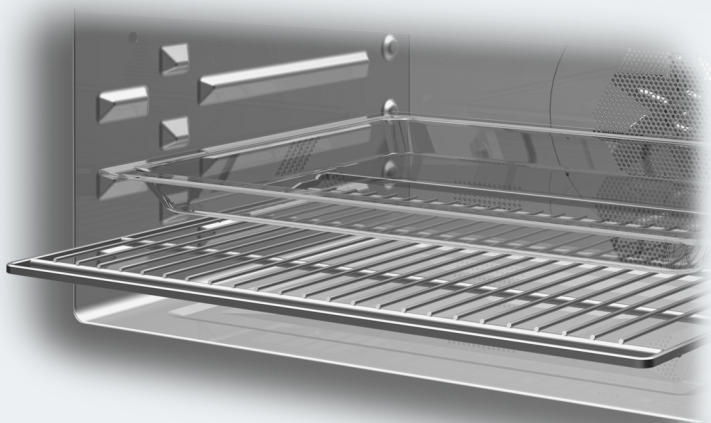

It is **essential** to read the operating and installation instructions before setup, installation, and commissioning. This prevents both personal injury and damage to the appliance.

PRECAUTIONS TO AVOID POSSIBLE EXPOSURE TO EXCESSIVE MICROWAVE ENERGY

PRECAUTIONS TO AVOID POSSIBLE EXPOSURE TO EXCESSIVE MICROWAVE ENERGY

- (a) Do not attempt to operate this oven with the door open since open-door operation can result in harmful exposure to microwave energy. It is important not to defeat or tamper with the safety interlocks.

- (b) Do not place any object between the oven front face and the door or allow soil or cleaner residue to accumulate on sealing surfaces.

- (c) Do not operate the oven if it is damaged. It is particularly important that the oven door close properly and that there is no damage to the: (1) Door (bent), (2) hinges and latches (broken or loosened), (3) door seals and sealing surfaces.

- (d) The oven should not be adjusted or repaired by anyone except properly qualified service personnel.

PRECAUTIONS TO AVOID POSSIBLE EXPOSURE TO EXCESSIVE MICROWAVE ENERGY	2
IMPORTANT SAFETY INSTRUCTIONS	6
Overview	20
H 7240 BM	20
H 7170 BM, H 7270 BM	21
Control panel	22
On/Off button	23
Display	23
Sensor buttons	23
Symbols	25
Using the appliance	26
Selecting a menu option	26
Changing a setting in a list	26
Changing the setting with a segment bar	26
Selecting an operating mode or function	27
Entering numbers	27
Activating MobileStart	27
Features	28
Data plate	28
Scope of delivery	28
Standard and optional accessories	28
Safety features	32
PerfectClean treated surfaces	32
Before first use	33
Miele@home	33
Basic settings	34
Heating the oven for the first time	35
Settings	36
Settings overview	36
Opening the “Settings” menu	38
Language 	38
Time	38
Lighting	39
Display	39
Volume	39
Units	40
Quick MW	40
Electrical version	40

Contents

Calibrate temperature.....	40
Popcorn.....	41
Booster.....	41
Recommended temps.....	41
Rec. power levels.....	41
Cooling fan run-on.....	42
Safety.....	42
Miele@home.....	43
RemoteUpdate.....	44
Remote control.....	45
Activating MobileStart.....	45
Software version.....	45
Showroom program.....	45
Factory default.....	45
Timer.....	46
Main and submenus.....	47
Microwave operation.....	48
How it works.....	48
Suitable dishware.....	48
Suitable dishware.....	49
Unsuitable dishware.....	51
Testing dishware.....	52
Cover.....	53
Operation.....	54
Changing values and settings for a cooking program.....	55
Changing the temperature.....	55
Changing the microwave power level.....	55
Setting additional durations.....	56
Changing set cooking durations.....	56
Deleting the set cooking durations.....	57
Interrupting a cooking process in the Microwave operating mode.....	57
Canceling a cooking program.....	57
Preheating the oven.....	58
Booster.....	58
Quick MW and Popcorn.....	59
Automatic programs.....	60
Categories.....	60
Using automatic programs.....	60
Usage notes.....	60

Additional applications	61
Defrost	62
Dehydrate	64
Reheat	65
Cooking	68
Canning	70
Frozen food/ready meals	73
Warm-up Cookware	73
Baking	74
Tips for baking	74
Notes on the operating modes	75
Roasting	76
Tips for roasting	76
Notes on the operating modes	77
Broiling	78
Tips for broiling	78
Notes on the operating modes	79
Cleaning and care of the oven	80
Unsuitable cleaning agents	80
Removing normal soiling	81
Removing stubborn soiling	82
Lowering the broiling element	83
Frequently asked questions	84
Customer Service	89
Contact in the event of a fault	89
Appliance warranty and product registration	89
Caring for the environment	90
Installation	91
Installation dimensions H 7240 BM	91
Installation in a tall or base cabinet	91
Side view	92
Connections and ventilation	93
Installation dimensions H 7170 BM, H 7270 BM	94
Installation in a tall or base cabinet	94
Side view	95
Connections and ventilation	96
Installing and removing the oven	97
Taking the oven out of the housing unit	98
Electrical connection	100
Declaration of conformity	101
Copyrights and licenses for the communication module	102

IMPORTANT SAFETY INSTRUCTIONS

When using the appliance, follow basic safety precautions, including the following:

Read all instructions before installation and use of the oven to prevent accidents and machine damage.

WARNING - To reduce the risk of burns, electric shock, fire, injury to persons, or exposure to excessive microwave energy:

This appliance complies with current safety requirements. Improper use of the appliance can lead to personal injury and material damage.

Read all instructions before installing or using the oven for the first time. Only use the appliance for its intended purpose.

Keep these operating instructions in a safe place and pass them on to any future user.

Read and follow the specific “PRECAUTIONS TO AVOID POSSIBLE EXPOSURE TO EXCESSIVE MICROWAVE ENERGY” found at the beginning of this manual.

Only use the appliance for its intended purpose. Install or locate this appliance only in accordance with the provided installation instructions and all local codes.

► For the sake of simplicity, the speed oven will subsequently be referred to as the “oven”.

Appropriate use

► This oven is intended for domestic use and use in other similar environments.

► The oven is not intended for outdoor use.

IMPORTANT SAFETY INSTRUCTIONS

▶ The oven is intended for cooking food – and, in particular, for baking, roasting, broiling, reheating, defrosting, and drying food – in domestic settings only.

All other types of use are not permitted.

▶ Risk of Fire! Do not use this oven to store or dry flammable materials.

▶ This oven can only be used by people with reduced physical, sensory, or mental capabilities or lack of experience and knowledge if they are supervised while using it.

They may only use it unsupervised if they have been shown how to do so in a safe manner. They must be able to understand and recognize the possible dangers caused by incorrect operation.

▶ The oven compartment is equipped with special bulbs to cope with particular conditions (e.g., temperature, moisture, chemical resistance, abrasion resistance, and vibration). These special bulbs must only be used for the purpose for which they are intended. They are not suitable for room lighting. Replacement bulbs should only be installed by a Miele authorized technician or by Miele Customer Service.

Safety with children

▶ Children should be supervised in the vicinity of the oven. Never allow children to play with the oven.

▶ Burn Hazard - Do not allow children to use the oven.

▶ Risk of suffocation from packaging material. While playing, children may become entangled in packaging material (such as plastic wrapping) or pull it over their head, presenting the risk of suffocation.

Keep packaging material away from children.

IMPORTANT SAFETY INSTRUCTIONS

▶ Risk of injury caused by hot surfaces. Children's skin is far more sensitive to high temperatures than that of adults. External parts of the oven such as the door glass, control panel, and the vent become quite hot.

Do not let children touch the oven when it is in operation.

▶ Risk of injury from the open door. The oven door can support a maximum weight of 17.5 lbs (8 kg). Children could injure themselves on an open door.

Do not let children sit on the door, lean against it, or swing on it.

Technical safety

▶ This appliance must be installed and connected in compliance with the installation instructions.

▶ Unauthorized installation, maintenance, and repairs can cause considerable danger for the user. Installation, maintenance, and repairs should only be carried out by a Miele authorized technician.

▶ Maintenance by the user: Never repair or replace any part of the appliance unless the instructions specifically recommend doing so. Service work should only be performed by a qualified technician.

▶ Damage to the oven can compromise your safety. Check the oven for visible signs of damage. Do not use a damaged oven.

▶ Temporary or permanent operation on an autonomous power supply system or a power supply system that is not synchronized with the grid power supply (e.g., island networks, back-up systems) is possible. A prerequisite for operation is that the power supply system complies with national and local codes.

The function and operation of the protective measures provided in the domestic electrical installation and in this Miele product must also be maintained in isolated operation or in operation that is not synchronized with the grid power supply, or these measures must be replaced by equivalent measures in the installation.

IMPORTANT SAFETY INSTRUCTIONS

- ▶ Operating a damaged oven can result in microwave leakage and present a hazard to the user. Do not use the oven if:
 - The door is warped.
 - The door hinges are loose.
 - Holes or cracks are visible in the casing, the door, or the oven compartment walls.
- ▶ The electrical safety of this appliance can only be guaranteed when correctly grounded. It is essential that this basic safety requirement is fulfilled. If in doubt, the electrical installation should be checked by a qualified electrician.
- ▶ Proper installation: Make sure that your appliance has been installed correctly and that it has been grounded by a qualified technician.
- ▶ The connection data (voltage and frequency) on the data plate of the oven must match the domestic electrical supply in order to avoid the risk of damage to the oven. Compare this before connecting the appliance to the domestic electrical supply. If in any doubt, consult a qualified electrician.
- ▶ Power bars and extension cords do not guarantee the required safety of the appliance. Do not use these to connect the oven to the power supply.
- ▶ For safety reasons, only use the oven when it has been fully installed.
- ▶ This appliance must not be used in a non-stationary location (e.g., on a ship).
- ▶ Risk of injury due to electric shock. Any contact with live connections or tampering with the electrical or mechanical components of the oven will endanger your safety and may lead to appliance malfunctions.
Do not open the oven housing under any circumstances.

IMPORTANT SAFETY INSTRUCTIONS

- ▶ While the appliance is under warranty, repairs should only be undertaken by a service technician authorized by Miele Customer Service. Otherwise the warranty will be invalidated.
- ▶ Miele can only guarantee the safety of the appliance when original Miele parts are used. Faulty components must only be replaced with genuine Miele parts.
- ▶ If the oven is delivered without a power cord, a special cord must be installed by a Miele authorized technician (see “Installation – Electrical connection”).
- ▶ If the power cord is damaged, it must be replaced with a special power cord by a Miele authorized technician (see “Installation – Electrical connection”).
- ▶ During installation, maintenance, and repair work, the oven must be completely disconnected from the power supply. To ensure this:
 - The circuit breakers have been switched off, or
 - the fuses of the electrical installation have been completely removed, or
 - the plug (if present) is removed from the outlet. To do this, pull the plug not the cord.
- ▶ The oven requires a sufficient supply of cool air for efficient operation. Make sure that the supply of cool air is not hindered in any way (e.g., by installing heat insulation strips in the cabinet niche). In addition, the required supply of cool air must not be excessively heated by other heat sources.
- ▶ If the oven is built in behind a cabinet door front, do not close the cabinet door while the oven is in use. Heat and moisture can build up behind the cabinet door when closed. This can result in damage to the oven, cabinet niche, and floor. Leave the cabinet door front open until the oven has cooled down completely.

IMPORTANT SAFETY INSTRUCTIONS

Correct use

- ▶ Caution: Heating elements may be hot even though they are not glowing. Interior surfaces of an oven become hot enough to cause burns. External parts of the oven such as the door glass, vents, and the control panel can become hot. During and after use, do not touch, or let clothing or other flammable materials come into contact with heating elements or interior surfaces of the oven until they have had sufficient time to cool.
- ▶ Do not let food sit in the oven for an extended period of time before or after cooking. Doing so can result in food poisoning or sickness.
- ▶ Loose fitting or hanging garments present a fire hazard. Wear proper apparel while operating the appliance.
- ▶ Use only dry, heat-resistant potholders. Moist or damp potholders used on hot surfaces may result in steam burns. Do not let potholders come in contact with oil or grease. Do not substitute dish towels or other bulky items for potholders. Do not let potholders touch hot heating elements.
- ▶ Open the door carefully to allow hot air or steam to escape before placing or removing food.
- ▶ To prevent burns, always place oven racks at their desired height while the oven is cool. If the rack must be moved while the oven is hot, do not let pot holders touch hot heating elements.
- ▶ To prevent burns, allow the heating elements to cool before cleaning by hand.
- ▶ Smother the fire or flames, or use a dry chemical extinguishing agent or foam fire extinguisher.
- ▶ Never store flammable liquids and materials in, above or under an oven, or near cooking surfaces.

IMPORTANT SAFETY INSTRUCTIONS

WARNING

NEVER use this appliance as a space heater to heat or warm the room. Doing so may result in carbon monoxide poisoning and overheating of the oven.

WARNING



NEVER use this appliance as storage space. Doing so may result in carbon monoxide poisoning and overheating of the oven.

WARNING

NEVER cover any slots, holes or openings in the oven bottom or cover an entire rack with materials such as aluminum foil. Doing so blocks air flow through the oven and may cause carbon monoxide poisoning. Aluminum foil linings may also trap heat, causing a fire hazard.

- ▶ Do not obstruct the flow of combustion and ventilation air.
- ▶ This oven must only be used for cooking food. Corrosive chemicals and vapors as well as fumes, vapors or heat given off by glues, plastics or flammable liquids and materials could be hazardous. Do not use it as a dryer, kiln, dehumidifier, etc.
- ▶ Do not let metal objects (aluminum foil, pans) come in contact with the heating element.
- ▶ Make certain that the power cords of small appliances do not come in contact with or get caught in the oven door.
- ▶ Risk of injury caused by hot surfaces. The oven gets hot during operation. You could burn yourself on the heating elements, oven compartment, accessories, or food.
When the oven is hot, use pot holders to insert, remove, or turn food, as well as when adjusting the oven shelves, etc.

IMPORTANT SAFETY INSTRUCTIONS

- ▶ To avoid fueling any flames, do not open the speed oven door if smoke occurs inside the appliance. Interrupt the process by turning the appliance off and disconnecting it from the power. Do not open the door until the smoke has dissipated.
- ▶ Due to the high temperatures radiated, objects left near the oven could catch fire. Do not use the oven to heat up the room.
- ▶ Oils and fats are a fire hazard if allowed to overheat. Never leave the oven unattended when cooking with oil or fats. Never attempt to put out oil or fat fires with water. Turn the oven off and extinguish the flames by leaving the door closed.
- ▶ Broiling food for excessively long cooking durations can cause it to dry out with the risk of catching fire. Do not exceed the recommended cooking durations.
- ▶ Please be aware that durations when using microwave power are often considerably shorter when cooking, reheating, and defrosting than when using operating modes without microwave power. Excessively long cooking durations can lead to food drying out and burning, or could even cause it to catch fire. Do not exceed recommended broiling durations when using broiling operating modes. Do not use the Microwave  operating mode to dry flowers or herbs, or to crisp up bread or rolls. Never use a broiling operating mode to dry flowers, herbs, or similar. Use the Convection Bake/Convection Roast  operating mode and always ensure this type of procedure is supervised.
- ▶ If using alcohol in your recipes, please be aware that high temperatures can cause the alcohol to evaporate. The vapor can catch fire on hot heating elements.

IMPORTANT SAFETY INSTRUCTIONS

- ▶ When using residual heat to keep food warm, corrosion from high air humidity and condensation can occur in the oven. This can cause damage to the control panel, countertop, and cabinet carcass. Keep the oven on and select the lowest temperature available for the selected operating mode. The cooling fan will then continue to run automatically.
- ▶ Food which is stored in the oven compartment or left in it to be kept warm can dry out and the moisture released can lead to corrosion damage in the oven. Always cover food that is left in the oven to keep warm.
- ▶ A buildup of heat can cause damage to the oven. Never line the floor of the oven with aluminum foil or oven liners. If you wish to place dishware on the floor of the oven during the cooking process, or place dishware on the floor of the oven to heat it up, you can do so, but only with the Convection Bake/Convection Roast  operating mode, without the Booster function.
- ▶ The oven floor can become damaged by items being pushed around on it. When placing pots, pans, or dishware on the oven floor, do not push them around.
- ▶ Risk of injury caused by steam. Pouring a cold liquid onto a hot surface creates steam, which can cause severe scalding. The sudden temperature change can also cause damage to hot surfaces. Never pour cold liquids directly onto hot enameled surfaces.
- ▶ The oven is not suitable for cleaning or disinfecting items. Items can get extremely hot. There is a risk of burning when items are removed from the oven.

IMPORTANT SAFETY INSTRUCTIONS

- ▶ It is important that the temperature in the food being cooked is evenly distributed and sufficiently high. You can ensure this by stirring or turning the food, and observing a sufficiently long standing time (see charts), which should be added to the time needed for reheating, defrosting, or cooking. During the standing time, the temperature is distributed evenly in the food.
- ▶ When heating food, and in particular liquids, using the Microwave  operating mode, the boiling point may be reached without the typical bubbles being produced. The liquid does not boil evenly throughout. This boiling delay can result in the liquid boiling over explosively. Take care when taking the container out of the oven, as the hot liquid can cause severe scalding. Under certain circumstances, the pressure can be so high that the door opens automatically. Stir liquids well before heating or cooking. After heating, wait at least 20 seconds before removing the container from the oven. In addition, you can place a glass rod or similar item, if available, in the container during the heating process.
- ▶ Risk of injury caused by hot food. When you heat food up, the heat is created directly in the food itself. For this reason, the dishware will remain cooler than the food (except when you use ovenproof stoneware). The dishware is only warmed by the heat of the food. Before serving, always check the temperature of the actual food itself after taking it out of the oven. The temperature of the container is not an indication of the temperature of the food or liquid in it. **This is particularly important when preparing food for babies, children, and the elderly or infirm.** After heating food, especially food for babies and small children, stir the food or shake the container and check that the temperature does not pose any danger of burning. Double check after it has been left to stand.

IMPORTANT SAFETY INSTRUCTIONS

- ▶ Risk of injury from increased pressure in sealed containers or bottles. Pressure can build up when reheating food or drinks in sealed containers or bottles, which can cause them to explode. Never cook or reheat food or liquids in sealed containers or bottles. Open containers beforehand and with baby bottles, the screw top and nipple must be removed.
- ▶ If you cook eggs without their shells, the yolks could explode due to the resulting pressure. Prick the yolk several times before cooking to avoid this.
- ▶ Eggs heated in their shell can burst, even after they have been removed from the oven. Eggs can only be cooked in their shells in a specially designed egg-boiling device. Do not reheat hard-boiled eggs using the Microwave  operating mode.
- ▶ Food with a thick skin or peel, such as tomatoes, sausage, potatoes, and eggplant can burst when heated or cooked. Pierce or score the skin of these foods several times to allow steam to escape.
- ▶ Do not use a thermometer containing mercury or liquid as these are not suitable for use with very high temperatures and break very easily. To check food temperature, first interrupt the cooking process. Only use a thermometer specifically approved for food use to measure the temperature of the food.
- ▶ Cushions or pads filled with cherry kernels, gel, etc., such as those used in aromatherapy, can ignite when heated, even after they have been removed from the oven. Do not heat these up in the oven.

IMPORTANT SAFETY INSTRUCTIONS

▶ Moisture can collect in the hollow spaces on dishware and lids with hollow handles or knobs. When the moisture evaporates, pressure can build up and the item can explode. If the hollow recess is sufficiently ventilated, the item can be used.

Do not use dishware with hollow knobs or handles when using the Microwave  operating mode.

▶ Non-microwave-safe plastic dishes can suffer damage or damage the oven if used with the Microwave  operating mode and microwave operating modes.

Do not use any containers or cutlery made from or containing metal, aluminum foil, lead crystal glassware, temperature-sensitive plastics, wooden utensils or cutlery, metal clips, or plastic or paper-covered wire ties. Do not use bowls with milled rims, or plastic pots with the foil lid only partially removed (see the requirements specified for dishware in the section on microwave operation).

▶ Plastic containers which are not heat-resistant melt and may ignite at high temperatures and can damage the oven.

Use only plastic containers that are suitable for use in an oven when using operating modes that do not use microwave power. Follow the manufacturer's instructions.

▶ Fire hazard due to containers made of flammable materials.



Plastic disposable containers must meet the requirements specified for dishware in the section on microwave operation.

Do not leave the oven unattended when heating or cooking food in disposable containers made of plastic, paper, or other flammable materials.

▶ Heat-retaining bags usually contain a thin layer of aluminum foil that reflects microwave radiation. As a result, the paper surrounding the aluminum foil can become so hot that it combusts.

Do not use heat-retaining packaging, such as bags for roasted chicken, for warming food with operating modes that use microwave power.

IMPORTANT SAFETY INSTRUCTIONS

- ▶ If the oven is used without food or the food is loaded incorrectly when using the Microwave  operating mode or operating modes that use microwave power, the oven can become damaged. Do not use any operating modes that use microwave power to preheat dishware or to dry herbs. Instead, use the Convection Bake/Convection Roast  operating mode.
- ▶ Canning food and heating it up in closed containers results in an increase in pressure which can cause them to explode. Do not use cans for canning or reheating food.
- ▶ Risk of injury from the open door. You could bang into the open door or trip over it. Do not leave the door open unnecessarily.
- ▶ The door can support a maximum load of 17.5 lbs (8 kg). Do not lean or sit on an open door, or place heavy items on it. Make sure that nothing gets trapped between the door and the oven compartment. This could damage the oven.

The following applies to stainless steel surfaces:

- ▶ Adhesives will damage the coated stainless steel surface and cause it to lose its dirt-repellent protective coating. Do not use sticky notes, adhesive tape, or other types of adhesive on the stainless steel surface.
- ▶ Magnets can cause scratches. Do not use the stainless steel surface as a magnetic notice board.

IMPORTANT SAFETY INSTRUCTIONS

Cleaning and care

- ▶ Risk of injury due to electric shock. The steam from a steam cleaning appliance could reach live electrical components and cause a short circuit. Never use a steam cleaner for cleaning.
 - ▶ Only clean parts listed in these operating and installation instructions.
 - ▶ Scratches on the door glass can cause the glass to break. Do not use abrasive cleaners, hard sponges, brushes, or sharp metal tools to clean the door glass.
 - ▶ Try to prevent the interior walls being splashed with food containing salt. If this does happen, wipe it away thoroughly to avoid corrosion to stainless steel surfaces inside the oven compartment.
 - ▶ In warm, moist environments, there is a higher probability of pest infestations. Ensure the oven and the area surrounding it are always kept clean.
- Damage caused by pests is not covered by the warranty.

Accessories

- ▶ Only use original Miele accessories. Using parts or accessories from other manufacturers will invalidate the warranty, and Miele cannot accept liability.

KEEP THE OPERATING AND INSTALLATION INSTRUCTIONS IN A SAFE PLACE AND REVIEW THEM PERIODICALLY.

Overview

Oven

H 7240 BM

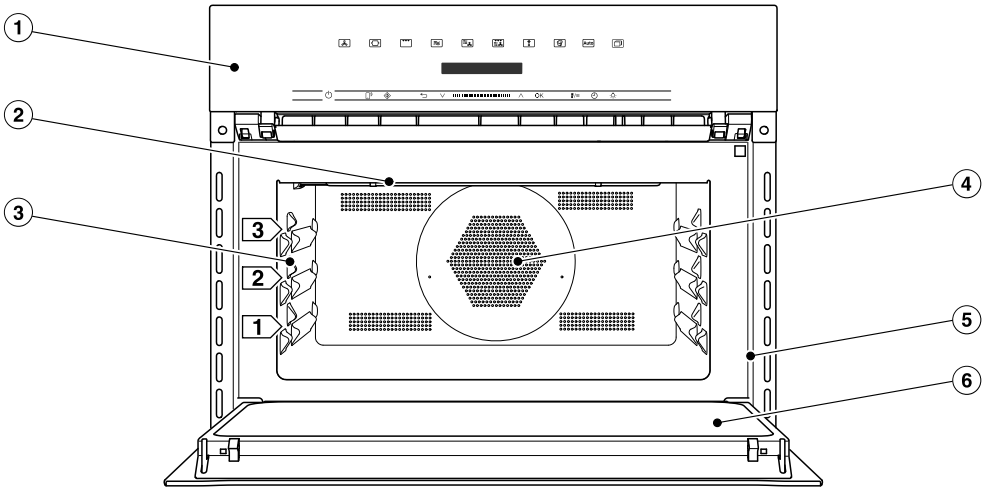

- ① Controls
- ② Broiling element
- ③ 3 shelf levels for the glass tray and wire rack
- ④ Convection fan with heating element
- ⑤ Front frame with data plate
- ⑥ Door



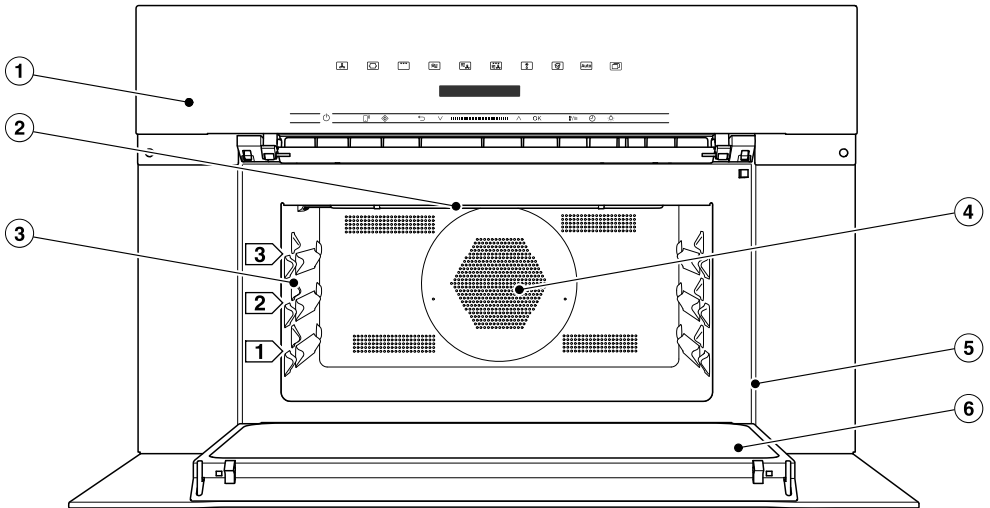



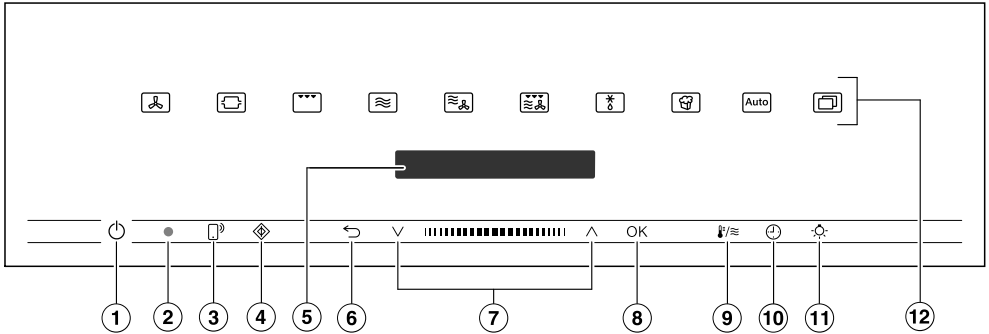

H 7170 BM, H 7270 BM



- ① Controls
- ② Broiling element
- ③ 3 shelf levels for the glass tray and wire rack
- ④ Convection fan with heating element
- ⑤ Front frame with data plate
- ⑥ Door

Control panel



- ① Recessed  On/Off button
For turning the oven on and off
- ② Optical interface
(for Miele Service only)
- ③  sensor button
For controlling the oven via your mobile device
- ④  sensor button
For starting the Quick MW function
- ⑤ Display
For displaying the time of day and information on operation
- ⑥  sensor button
For going back a step and for changing menu options during a cooking process
- ⑦ Navigation area with  and  arrow buttons
For scrolling through lists and for changing values
- ⑧ *OK* sensor button
For accessing functions and saving settings
- ⑨  sensor button
For changing the temperature or the power level
- ⑩  sensor button
For setting a timer, the cooking duration, or the start or finish time for the cooking program
- ⑪  sensor button
For switching the oven interior lighting on and off
- ⑫ Sensor buttons
For selecting operating modes, automatic programs, and settings

On/Off button

The  On/Off button is recessed and reacts to touch.

Use this button to turn the oven on and off.

Display

The display is used for showing the time of day or information about operating modes, temperatures, cooking durations, automatic programs, and settings.

After turning the oven on with the  On/Off button, Select operating mode will appear in the main menu.

Sensor buttons

The sensor buttons react to touch. Every tap of a sensor button is confirmed with an audible keypad tone. You can turn this keypad tone off using More  | Settings | Volume | Keypad tone.





If you want the sensor buttons to respond even when the oven is turned off, select the Display | QuickTouch | On setting.

Sensor buttons above the display



For information on the functions and operating modes, see “Main and submenus”, “Settings”, “Automatic programs”, and “Further applications”.

Control panel

Sensor buttons under the display





Sensor button	Function
	<p>If you want to control the oven from your mobile device, you must have the Miele@home system, turn on the Remote control setting, and tap this sensor button. The sensor button then lights up and the MobileStart function is available.</p> <p>As long as this sensor button is illuminated, you can control the oven via your mobile device (see “Settings – Miele@home”).</p>
	<p>Use this sensor button to start the Quick MW function. The cooking process runs with the maximum power level (level 7) and a cooking duration of 1 minute (see section “Quick MW”). Touching the sensor button repeatedly increases the cooking duration in increments.</p> <p>This function can only be used when no other cooking processes are in use.</p>
	<p>Depending on which menu you are in, this sensor button will take you back a level or back to the main menu.</p> <p>If a cooking program is in progress at the same time, use this sensor button to cancel the program.</p>
	<p>In the navigation area, use the arrow buttons or the area between them to scroll up or down in the lists. The display shows the menu option that you want to select.</p> <p>You can change the values and settings using the arrow buttons or the area between them.</p>
OK	<p>As soon as you reach a confirmable value, message, or setting, the OK sensor button will light up orange.</p> <p>By selecting this sensor button you can access functions such as the timer, save changes to values or settings, or confirm instructions.</p> <p>You can start, interrupt, and continue a cooking process using microwave power with the OK sensor button.</p>

Control panel

Sensor button	Function
	<p>During the heating-up phase or during a cooking process, you can use this sensor button to change the temperature or the microwave power level.</p> <p>You can change the temperature for operating modes which do not use microwave power.</p> <p>In operating modes which use microwave power you can change the microwave power level.</p>
	<p>If no cooking program is in progress, you can use this sensor button to set a timer (e.g., when boiling eggs) at any point.</p> <p>If a cooking program is in progress at the same time, you can set a timer, the cooking duration, and a start or end time for the program.</p>
	<p>Select this sensor button to turn the oven interior lighting on and off.</p> <p>Depending on the setting selected, the oven interior lighting turns off after 15 seconds or remains constantly turned on or off.</p>

Symbols

The following symbols may appear on the display:

Symbol	Meaning
	This symbol indicates that there is additional information and advice about using the appliance. Select <i>OK</i> to confirm the information.
	Timer
	A check indicates the option which is currently selected.
	Some settings, e.g., display brightness and signal tone volume, are selected using a segment bar.
	The system lock prevents the oven being switched on by mistake (see “Settings – Safety”).

Using the appliance

Use the \wedge and \vee arrow buttons or the **|||||** area between them in the navigation area to use the oven.

As soon as you reach a confirmable value, message, or setting, the OK sensor button will light up orange.

Selecting a menu option

- Touch the \wedge or \vee arrow buttons or swipe to the right or left in the **|||||** area until you reach the desired menu option.

Tip: If you press and hold an arrow button, the list continues scrolling automatically until you release the arrow button.

- Confirm your selection with *OK*.

Changing a setting in a list

A \checkmark check will appear beside the current setting.

- Touch the \wedge or \vee arrow buttons or swipe to the right or left in the **|||||** area until you reach the desired value or setting.
- Confirm with *OK*.

The setting is now saved. This will take you back to the previous menu.

Changing the setting with a segment bar

Some settings are represented by a **■■■■■** bar made up of segments. If all of the segments are illuminated, the maximum value is selected.

If none of the segments are illuminated or if only one is, the minimum value is selected or the setting is turned off altogether (e.g., volume).

- Touch the \wedge or \vee arrow buttons or swipe to the right or left in the **|||||** area until you reach the desired setting.
- Confirm your selection with *OK*.

The setting is now saved. This will take you back to the previous menu.

Selecting an operating mode or function

The sensor buttons for the operating modes and functions (e.g., More ) are located above the display (see “Controls” and “Settings”).

- Touch the sensor button for the desired operating mode or function.

The sensor button on the control panel lights up orange.

- For operating modes and functions: set values such as the temperature.
- Under More : scroll through the lists until you reach the desired menu option.
- Confirm with *OK*.

Changing the operating mode

You can change to another operating mode during a cooking program.

The sensor button for the previously selected function lights up orange.

- Touch the sensor button of the new operating mode or function.

The new operating mode will appear on the display with its corresponding recommended values.

The sensor button for the new operating mode lights up orange.

Under More , scroll through the lists until you reach the desired menu option.

Entering numbers

Numbers that can be changed are highlighted.

- Touch the \wedge or \vee arrow buttons or swipe to the right or left in the  area until the desired number is highlighted.

Tip: If you press and hold an arrow button, the numbers continue scrolling automatically until you release the arrow button.

- Confirm with *OK*.

The changed number is now saved. This will take you back to the previous menu.

Activating MobileStart

- Select the  sensor button to activate MobileStart.

The  sensor button lights up. You can operate your oven remotely with the Miele app.

Directly operating on the oven takes priority over operating it via the remote control function on the app.

You can use MobileStart as long as the  sensor button is lit up.

Features

A list of the models described in these operating and installation instructions can be found on the back page.

Data plate

The data plate located on the front frame of the oven is visible when the door is open.

The data plate states the model number, the serial number, and connection data (voltage, frequency, and maximum rated load).

Have this information available if you need to contact Miele so that any issues can be rectified as quickly as possible.

Scope of delivery

- Operating and installation instructions for using the oven and microwave functions
- Screws for securing the oven to the cabinet niche
- Various accessories

Standard and optional accessories

This oven is supplied with a glass tray and wire rack.

All accessories and cleaning and care products in these instructions are designed to be used with Miele Ovens.

These can be ordered from the Miele web store, Miele Customer Service, or from your Miele dealer.

When ordering, please have your model number ready along with the desired accessories.

Glass tray

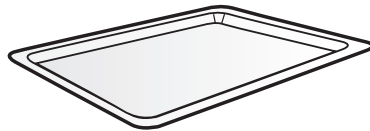



The glass tray is suitable for use with all operating modes.

The glass tray can be damaged by large temperature fluctuations. Do not place the hot glass tray on a cold surface, such as a tiled or granite countertop. Use a suitable mat or pot rest.

- **Always** use the glass tray with the Microwave  operating mode, even if you use it as a shelf for smaller dishes.
- The maximum load for the glass tray is 17.6 lb (8 kg).

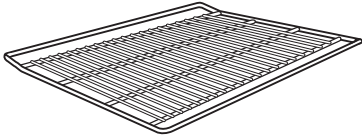
Wire rack with non-tip safety notches



The wire rack is **not** suitable for use with the Microwave  operating mode. You can use the wire rack for all other operating modes which use or do not use microwave power.

 Danger of injury caused by hot surfaces.

The wire rack gets hot during cooking processes.

Use pot holders when placing food in the appliance or removing it and when working in the hot oven cavity.

The oven and wire rack can be damaged by the possible creation of sparks.

Do not use the wire rack for cooking processes with the Microwave  operating mode.

Do not place the wire rack on the oven floor. Place it on one of the shelf levels.

Using the wire rack

The wire rack has non-tip safety notches. These prevent it being pulled right out when it only needs to be pulled out partially.

If you insert the wire rack the wrong way round, the non-tip safety mechanism is not guaranteed.

When pushing the wire rack back in, always ensure that the safety notches are at the **back** of the oven.

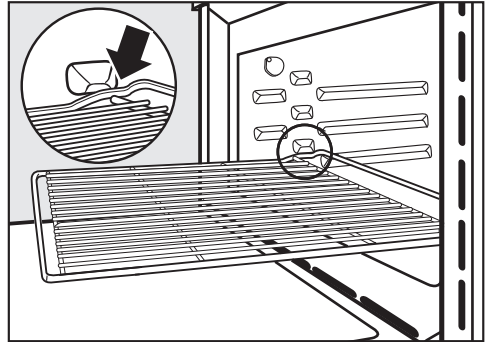

- To remove the wire rack, lift it upwards slightly at the front when the safety notches connect with the sides of the oven.



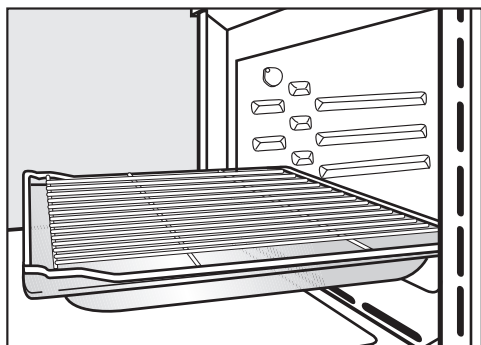

Features



- It is recommended to use the wire rack together with the glass tray when cooking items on the rack which might drip. Only in this case should the safety notches be at the front.
- The maximum load for the wire rack is 17.6 lb (8 kg).

Round baking pans

Round baking trays can suffer damage when subjected to microwaves.

Do not use round baking trays with the Microwave , Combi Auto Roast , Combi Conv Bake/Combi Convection Roast , Combi Broil , or Combi Conv Broil  operating modes.



The **solid round baking pan HBF 27-1** is suitable for cooking pizzas, flat cakes, sweet and savory tarts, baked desserts, flat bread, and can also be used for frozen cakes.

The **perforated round baking pan HBFP 27-1** has been specially developed for baked goods made from fresh yeast dough, and for baking bread and rolls. The tiny perforations assist in browning the underside of baked goods.

They can also be used for dehydrating or drying food.

The enameled surface of both baking pans has been treated with PerfectClean.

- Insert the wire rack and place the round baking pan on the rack.

HUB Gourmet Casserole Dishes HBD Gourmet Casserole Dish lids

Gourmet Casserole Dishes and their lids can suffer damage when subjected to microwaves. Metal reflects the microwaves which can create sparks and the microwaves are not absorbed by the metal.

Only use the casserole dishes and their lids for cooking processes with operating modes which **do not use** microwave power.

Insert the wire rack in shelf level 1 and place the Gourmet Casserole Dish on the wire rack.

The surface of the Gourmet Casserole Dishes has a non-stick coating and is suitable for induction cooktops.

Gourmet Casserole Dishes are available in different depths. The width and the height are the same.

Suitable lids are available separately. Please quote the model designation when ordering.

Depth:
8 1/2" (22 cm)

HUB 62-22

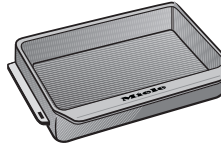

HBD 60-22

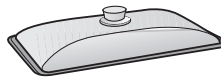

Depth:
13 3/4" (35 cm)*

HUB 62-35

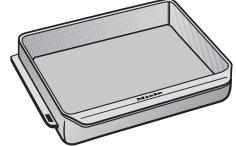

HBD 60-35

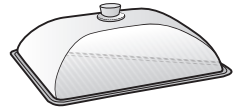

* The casserole dish cannot be used in conjunction with this lid in ovens with 3 shelf levels because the total height would exceed the height of the oven cavity.

Features

Safety features

- **System lock** 
(see “Settings – Safety”)
- **Sensor lock**
(see “Settings – Safety”)
- **Cooling fan**
(see “Settings – Cooling fan run-on”)
- **Safety shut-off**

An operating mode which does not use microwave power can be started without selecting a cooking duration. To prevent continuous use and avoid the risk of fire, the oven will switch itself off automatically after a certain time has elapsed following the last operation, depending on the operating mode and temperature selected.

PerfectClean treated surfaces

PerfectClean surfaces have very good non-stick properties making them exceptionally easy to clean.

Food can be easily removed from these surfaces. Soiling from baking and roasting can also be easily removed from these surfaces.

However, do not use ceramic knives as these will scratch the PerfectClean surface.

Read the instructions in “Cleaning and care of the oven” to retain the benefits of the non-stick properties and easy cleaning.

PerfectClean treated surfaces:

- Oven cavity
- Wire rack
- Round perforated baking pan
- Round baking pan

Miele@home

Your oven is equipped with an integrated WiFi module.

To use this feature, you will need:

- A WiFi network
- The Miele app
- A Miele user account. You can create a user account via the Miele app.

The Miele app will guide you as you connect your oven to your home WiFi network.

Once your oven is connected to your WiFi network, you can use the app to carry out various activities, such as:

- Call up information on the operating status of your oven
- Retrieve information on cooking processes that are in progress
- Stop cooking programs that are in progress

Connecting your oven to your WiFi network will increase energy consumption, even when the oven is turned off.

Make sure that the signal of your WiFi network is sufficiently strong in the place where your oven is installed.

Availability of the WiFi connection

The WiFi connection shares a frequency range with other appliances (including microwave ovens and remote control toys). This can cause sporadic or even complete connection failures.

Therefore, the availability of featured functions cannot be guaranteed.

Miele@home availability

The ability to use the Miele app depends on the availability of the Miele@home service in your country.

The Miele@home service is not available in every country.

For information about availability, please visit www.miele.com.

Miele App

The Miele App is available to download free of charge from the Apple App Store® or from the Google Play Store™.



Before first use

Basic settings

You must make the following settings before starting up for the first time. You can change these settings again at a later time (see “Settings”).

 Risk of injury caused by hot surfaces.

The oven gets hot during operation. For safety reasons, only use the oven when it has been fully installed.

The oven will turn on automatically when it is connected to the electrical supply.

Setting the language

- Select the desired language.

If you have accidentally selected a language that you don't understand, proceed as described in “Settings – Language ”.

Setting the location

- Select the required location.

Setting up Miele@home

Set up “Miele@home” will appear on the display.

- To set up Miele@home now, confirm by touching *OK*.
- To set it up at a later date, select *Skip* and confirm with *OK*. See “Settings – Miele@home” for information on setting up at a later date.

- To set up Miele@home immediately, select the connection method you want to use.

You will then be guided by the display and the Miele app.

Setting the time

- Set the time of day in hours and minutes.
- Confirm with *OK*.

Setting the voltage

 The set voltage variant must match the voltage of the domestic electrical supply in order to avoid the risk of damage to the oven.

Confirm the voltage before setting. If in any doubt, consult a qualified electrician.

- Select the voltage variant.
- Confirm with *OK*.

Completing the commissioning process

- Follow any further instructions on the display.

The appliance is now ready for use.

Heating the oven for the first time

New ovens may have a slight odor when they are heated up for the first time. This can be eliminated by heating the empty oven for at least an hour.

Ensure that the kitchen is well ventilated while the appliance is being heated up for the first time. Close doors to other rooms to prevent the odor spreading throughout the house.

- Remove any adhesive labels or protective films from the ovens and accessories.
- Take all accessories out of the oven cavity and clean them (see “Cleaning and care”).
- Before heating the oven up, wipe the interior with a damp cloth to remove any dust or bits of packaging that may have accumulated in the oven cavity.
- Turn the oven on using the  On/Off button.

Select operating mode **appears**.

- Select Convection Bake .

350°F (160°C) will appear as a recommended value.

The oven heating, lighting, and cooling fan will turn on.

- Set the highest possible temperature.
- Confirm with *OK*.

Heat up the oven for at least an hour.

- After at least an hour, turn the oven off with the  On/Off button.

Cleaning the oven cavity after heating it up for the first time

 Danger of injury caused by hot surfaces.







The oven gets hot during operation. You could burn yourself on the heater elements and the oven cavity. Allow the heater elements and oven cavity to cool before manual cleaning.

- Clean the oven cavity with warm water and liquid dish soap, applied with a soft sponge or microfiber cloth.
- Dry all surfaces with a soft cloth.

Leave the oven door open until the oven cavity is completely dry.

Settings

Settings overview

Menu option	Available settings
Language 	... deutsch english ... Location
Time	Display On* Off Night dimming Clock format 12 h* 24 h Set
Lighting	On "On" for 15 seconds* Off
Display	Brightness  QuickTouch On Off*
Volume	Buzzer tones Melodies*  Solo Tone  Keypad tone  Welcome Melody On* Off
Units	Weight g lb/oz lb* Temperature °C °F*
Quick MW	Power level Duration
Electrical version	208V / 60Hz 220V / 60Hz 240V / 60Hz
Calibrate temperature	
Popcorn	Duration
Booster	On* Off
Recommended temps.	
Rec. power levels	

* Factory default



Menu option	Available settings
Cooling fan run-on	Temperature controlled* Time controlled
Safety	Sensor lock On Off* System lock  On Off*
Miele@home	Activate Deactivate Connection status Set up again Reset Set up
Remote control	On* Off
RemoteUpdate	On* Off
Software version	
Showroom program	Demo Mode On Off*
Factory default	Appliance settings Rec. power levels Recommended temps.

* Factory default

Settings

Opening the “Settings” menu

In the More  | Settings menu, you can personalize your oven by adapting the factory default settings to suit your requirements.

- Select More .
- Select Settings .
- Select the setting you want.



You can check settings or change them.

You cannot change settings while a cooking program is in progress.

Language

You can set your language and location.

After selecting and confirming your choice, the language you have selected will appear on the display.

Tip: If you have selected the wrong language by mistake, select the  sensor button. Follow the  symbol to get back to the Language  submenu.

Time

Display

Select how you want the time of day to show on the display when the oven is turned off:

- On
The time is always visible on the display.
If you also select the Display | QuickTouch | On setting, all sensor buttons will react to touch straight away.
If you also select the Display | QuickTouch | Off setting, the oven has to be turned on before it can be used.
- Off
The display appears dark to save energy. The oven has to be turned on before you can use it.
- Night dimming
To save energy, the time only shows on the display between 5:00 a.m. and 11:00 p.m. The display remains dark at all other times.

Clock format

The time of day can be displayed in the 24 or 12-hour format (24 h or 12 h).



Set

Set the hours and the minutes.

If there is a power failure, the current time of day will reappear once the power has been restored. The time of day is saved for approx. 150 hours.

If the oven has been connected to a WiFi network and signed into the Miele app, the time will be synchronized based on the location setting in the Miele app.



Lighting

- On
The oven interior lighting is turned on during the entire cooking period.
- "On" for 15 seconds
The oven interior lighting turns off 15 seconds after a cooking program has begun. Press the  sensor button to turn the oven interior lighting on again for 15 seconds.
- Off
The oven interior lighting is turned off. Press the  sensor button to turn the oven interior lighting on for 15 seconds.

Display

Brightness

The display brightness is represented by a segment bar.

- 
Maximum brightness
- 
Minimum brightness

QuickTouch

Select how the sensor buttons should respond when the oven is turned off:

- On
If you have also selected the Time | Display | On or Night dimming setting, the sensor button will also respond when the oven is turned off.
- Off
Regardless of the Time | Display setting, the sensor buttons only respond when the oven is turned on, as well as for a certain amount of time after turning it off.

Volume



Buzzer tones

If audible signals are turned on, an audible signal will sound when the set temperature is reached and at the end of a set time.

Melodies

At the end of a process, a melody will sound several times at intervals.

The volume of the melody is represented by a segment bar.

- 
Maximum volume
- 
Melody is turned off

Settings

Solo Tone

At the end of a process, a continuous tone will sound for a period of time.

The pitch of this continuous tone is represented by a segment bar.

- 
Maximum pitch

- 
Minimum pitch

Keypad tone

The volume of the tone that sounds each time you tap a sensor button is represented by a segment bar.

- 
Maximum volume

- 
Keypad tone is turned off

Welcome Melody

The melody that sounds when you tap the  On/Off button can be turned on or off.

Units

Weight

For MasterChef programs, you can set the weight of food in grams (g), pounds/ounces (lb/oz) or pounds (lb).

Temperature

You can set the temperature in Celsius (°C) or Fahrenheit (°F).

Quick MW

For an immediate start of the microwave, a microwave power level of 7 and a cooking duration of 1 minute are preset.

- Power level
You can select a microwave power level from 1 through 7.
- Duration
The maximum cooking duration that can be set depends on the microwave power level selected:
Power level 1 through 3: maximum 10 minutes
Power level 4 through 7: maximum 5 minutes

Electrical version

You can set the voltage variant. The setting must correspond to the voltage of your domestic electrical supply.

Calibrate temperature

You can change the temperature in increments in all operating modes and automatic programs so that it is higher or lower in the oven compartment than displayed.

The temperature calibration is represented by a bar with seven segments.



If all of the segments are filled, the oven compartment temperature is much higher than displayed. If one segment is filled, the oven compartment temperature is much lower than displayed.

Popcorn

For an immediate start of the microwave for preparing popcorn, a microwave power level of 6 and a cooking duration of 2:50 minutes are preset. These settings match the manufacturer's instructions on most bags of microwave popcorn.

The maximum cooking duration that can be set is 4 minutes.

The microwave power level is set and cannot be modified.

Booster

The **Booster** function is used to quickly preheat the oven.

- On
The **Booster** function is automatically turned on during the heating-up phase of a cooking process. The broiling element, ring heater element, and blower preheat the oven cavity to the set temperature at the same time.
- Off
The **Booster** function is turned off during the heating-up phase of a cooking process. Only the heater elements for the selected operating mode are used to preheat the oven cavity.

Recommended temps.

If you often cook with temperatures that differ from the default, the recommended temperatures can be changed.

After selecting this menu option, the list of operating modes will appear in the display together with their recommended temperatures.

- Select the operating mode you want to use.
- Change the recommended temperature.
- Confirm with **OK**.





Changing the recommended temperature also affects the corresponding operating mode which uses microwave power.

Rec. power levels

If you often cook with microwave power levels that differ from the default, it makes sense to change the default temperatures.

You can change the default power levels for the Microwave  operating mode and for the operating modes which use microwave power.

After selecting this menu option, a list of operating modes will appear in the display together with their default power levels.

- Microwave :
Power levels 1 through 7
- Combi Auto Roast , Combi Conv Bake/Combi Convection Roast , Combi Broil , and Combi Conv Broil :
Power levels 1 through 3

- Select the operating mode you want to use.
- Change the default power level.
- Confirm with **OK**.

Settings

Cooling fan run-on

The cooling fan will continue to run for a while after the oven has been turned off to prevent any humidity building up in the oven, on the control panel, or in the cabinet carcass.

- Temperature controlled
The cooling fan turns off when the temperature in the oven drops below approx. 160°F (70°C).
- Time controlled
The cooling fan turns off after a period of about 25 minutes.

Condensation can damage the cabinet carcass and the countertop. This could lead to corrosion of the oven.

When keeping food warm in the oven, increases to the Time controlled setting can lead to condensation in the control panel and moisture on the countertop and cabinet doors.

Do not adjust the Time controlled setting and try not to leave food in the warm oven.

Safety

Sensor lock

The sensor lock prevents the cooking program from being turned off by mistake or settings from being changed. Once activated, the sensor lock prevents the sensor buttons and fields on the display from working for a few seconds after a program has been started, with the exception of the  On/Off button.

- On
The sensor lock is active. Touch *OK* sensor button for at least 6 seconds to deactivate the sensor lock for a short period of time.
- Off
The sensor lock is not active. All sensor buttons react to touch as normal.

System lock

The system lock prevents the oven from being turned on inadvertently.

You can still set a timer as well as use the MobileStart function when the system lock is active.

The system lock will remain activated even after a power failure.

- On
The system lock is now active. Before you can use the oven, touch the *OK* sensor button for at least 6 seconds.
- Off
The system lock is now deactivated. You can use the oven as normal.

Miele@home

The oven is a Miele@home-compatible appliance. Your oven is equipped ex-works with a WiFi communication module and is suitable for wireless communication.

There are a number of ways of connecting your oven to your WiFi network. We recommend connecting your oven to your WiFi network using the Miele app or via WPS.

- Activate
This setting is only visible if Miele@home is deactivated. The WiFi function is reactivated.
- Deactivate
This setting is only visible if Miele@home is activated. Miele@home remains set up; the WiFi function is turned off.
- Connection status
This setting is only visible if Miele@home is activated. The display shows information such as the WiFi reception quality, network name, and IP address.
- Set up again
This setting is only visible if a WiFi network has already been set up. Reset the network settings and set up a new network connection straight away.
- Reset
This setting is only visible if a WiFi network has already been set up. The WiFi function is deactivated and the WiFi connection will be reset to the factory default. You must set up a new WiFi connection to be able to use Miele@home.
Reset the network settings if you are disposing of or selling your oven, or if you are putting a used oven into operation. This is the only way to ensure that all personal data has been removed and the previous owner will no longer be able to access the oven.
- Set up
This setting is only visible if no WiFi connection has been set up yet. You must set up a new WiFi connection to be able to use Miele@home.

Settings

RemoteUpdate

The RemoteUpdate menu option is only displayed and can only be selected if the requirements for using Miele@home have been met (see “Before using for the first time – Miele@home”).

The RemoteUpdate function is used for updating the software in your oven. If an update is available for your oven, it will automatically download it. Updates will not be installed automatically. They must be initiated manually.

If you do not install an update, you can continue to use your oven as usual. However, Miele recommends installing updates.

Activating/deactivating

The RemoteUpdate function is activated as standard. Available updates will be downloaded automatically but will only be installed if you initiate installation manually.

Deactivate RemoteUpdate if you do not want any updates to be downloaded automatically.

Running a RemoteUpdate

Information about the content and scope of an update is provided in the Miele app.

A message will appear on your oven display if a software update is available.

You can install the update immediately or postpone this until later. When the oven is turned on again, you will be reminded about the update.

Deactivate RemoteUpdate if you do not want to install the update.

The update may take several minutes.

Please note the following information about the RemoteUpdate function:

- You will only receive a message when an update is available.
- Once an update has been installed, it cannot be undone.
- Do not turn the oven off during the update. Otherwise, the update will be aborted and will not be installed.
- Some software updates can only be carried out by Miele Customer Service.

Remote control

If you have installed the Miele app on your mobile device, have access to the Miele@home system, and have activated the remote control function (On), you can use the MobileStart function to retrieve information on oven cooking programs that are in progress or to end a program in progress.

Activating MobileStart

- Select the  sensor button to activate MobileStart.

The  sensor button lights up. You can operate your oven remotely with the Miele app.

Directly operating on the oven takes priority over operating it via the remote control function on the app.

You can use MobileStart as long as the  sensor button is lit up.

Software version

The software version menu option is for use by Miele Customer Service. You do not need this information for domestic use.

Showroom program

This function enables the oven to be demonstrated in showrooms without heating up. Do not activate this setting for domestic use.

Demo Mode

If you have Demo mode activated, Demo mode is active. The appliance will not heat up will appear when you turn on the oven.

- On
Touch the OK sensor button for at least 4 seconds to activate Demo mode.
- Off
Touch the OK sensor button for at least 4 seconds to deactivate Demo mode. You can use the oven as normal.

Factory default

- Appliance settings
Any settings that have been altered will be reset to the factory default settings.
- Rec. power levels
Microwave power levels which have been changed will be reset to the factory default settings.
- Recommended temps.
Any recommended temperatures that have been changed will be reset to the factory default settings.

Timer

Using the Timer function

The  timer can be used to time other activities in the kitchen, e.g., boiling eggs.

The timer can also be used at the same time as a cooking program for which the start and finish times have been set (e.g., as a reminder to stir the food or add seasoning, etc.).

- The maximum timer duration that can be set is 59 minutes and 59 seconds.

Setting the timer

If you have selected the Display | QuickTouch | Off setting, you will need to turn the oven on before setting the timer. The timer can then be seen counting down on the display when the oven is turned off.

Example: You want to boil some eggs and set a timer of 6 minutes and 20 seconds.

- Select the  sensor button.
- Select Timer if a cooking program is in progress at the same time.

The prompt Set 00:00 min will appear.

- Using the navigation area, set 06:20.
- Confirm with *OK*.

The timer duration is now saved.

When the oven is turned off, the timer duration counts down on the display and  appears instead of the time of day.

If you are cooking at the same time **without** a set cooking duration,  and the timer time will appear as soon as the selected temperature is reached.

If you are cooking at the same time **with** a set cooking duration, the timer will count down in the background as the cooking duration takes priority in the display.

If you are in a menu, the timer will count down in the background.

At the end of the timer duration,  will flash, the time will start counting up, and an audible signal will sound.

- Select the  sensor button.
- If required, confirm with *OK*.

The audible signal will stop and the symbols on the display will go out.

Changing the timer

- Select the  sensor button.
- Select Timer if a cooking program is in progress at the same time.
- Select Change.
- Confirm with *OK*.

The timer appears.

- Change the time set for the timer.
- Confirm with *OK*.

The altered timer time is now saved.











Deleting the timer

- Select the  sensor button.
- Select Timer if a cooking program is in progress at the same time.
- Select Delete.
- Confirm with *OK*.

The timer is deleted.

Main and submenus

As different countries have different preferences when it comes to preparing food, the temperatures in °F and °C may not match. The temperatures are defined as they are specified in the table.

Menu	Recommended value	Range
Operating Modes		
Convection Bake 	350°F (160°C)	85–475°F (30–250°C)
Auto Roast 	350°F (160°C)	200–450°F (100–230°C)
Maxi Broil 	3	1–3
Microwave 	7	1–7
Combi Conv Bake/ Combi Convection Roast 	3 325°F (160°C)	1–3 85–450°F (30–220°C)
Combi Conv Broil 	3 350°F (200°C)	1–3 200–400°F (100–200°C)
Defrost 	75°F (25°C)	75–125°F (25–50°C)
Popcorn 	6	–
Automatic programs 		
More 		
Convection Roast	375°F (170°C)	85–475°F (30–250°C)
Convection Broil	350°F (200°C)	200–475°F (100–220°C)
Combi Broil	3 3	1–3 1–3
Combi Auto Roast	3 350°F (160°C)	1–3 200–400°F (100–200°C)
Settings 		

Microwave operation

How it works

The oven contains a magnetron that converts electrical energy into electromagnetic waves (microwaves). These microwaves are distributed evenly throughout the oven cavity and are reflected off the metal walls of the oven.

The microwaves penetrate the food from all sides. Food consists of many molecules. When subjected to microwave energy, these molecules (particularly the water molecules) start to oscillate. This heats the food from the outside to the inside. The more water a food contains, the faster it is reheated or cooked.

Advantages of the microwave oven

- Food can generally be cooked with little or no liquid or cooking oil.
- The times for defrosting, reheating, or cooking are shorter than with a cooktop or oven.
- Vitamins, minerals, natural color, and taste of the food are generally retained.

Suitable dishware

In order for microwaves to reach the food, they must be able to penetrate the dishware being used. Microwaves can pass through porcelain, glass, cardboard, and plastics, but not metal. Therefore, do not use metal containers or dishware that contains metal. Metal reflects the microwaves which can create sparks and the microwaves are not absorbed by the metal.

 Danger of injury from increased pressure in sealed containers or bottles

Pressure can build up during reheating in sealed containers or bottles, causing them to explode. Never cook or reheat solid or liquid food in sealed containers or bottles. Open containers beforehand and with baby bottles, the screw top and teat must be removed.

 Risk of fire due to using unsuitable dishware for operating modes which use microwave power.

Dishware which is not suitable for use in microwave ovens can be badly damaged and cause damage to the appliance if used. Only use microwave-safe dishware for operating modes which use microwave power.

The material and shape of dishware used affect reheating and cooking durations.

Heat distribution is more even in round and oval-shaped flat containers. Food is reheated more evenly in these containers than in square containers.

Suitable dishware

 Fire hazard due to flammable materials.

Disposable containers made out of plastic, paper, or other flammable materials can ignite, causing damage to the oven.

Do not leave the oven unattended when reheating or cooking food in disposable containers made of plastic, paper, or other flammable materials.

You can use the following dishware and materials:

- Heat-resistant glass and ceramic glass
Exception: crystal glass as it contains lead and may crack.
- Porcelain
 - Without metallic decoration
Metallic decoration (e.g., gold rims or cobalt blue) can cause sparking.
 - Without hollow knobs and handles
Moisture can gather in hollow knobs and handles. When the moisture evaporates, pressure can build up and the item can explode.
- Unpainted stoneware and stoneware with underglaze paints

 Danger of injury caused by hot dishware.





Stoneware can get hot.
Use pot holders when using stoneware.

- Plastic dishware and disposable plastic containers with the Microwave  operating mode

Tip: To protect the environment, avoid the use of disposable containers.

Plastic dishware must be heat-resistant to a minimum of 230°F (110°C). Otherwise, the plastic may melt and fuse with the food.

Only use plastic dishware with the Microwave  operating mode.





Do not use plastic dishware with the Combi Auto Roast , Combi Conv Bake/Combi Convection Roast , Combi Broil , or Combi Conv Broil  operating modes.





- Microwave-safe plastic dishware
Special plastic dishware designed for use in microwave ovens is available from retail outlets.
- Styrofoam dishware
For briefly heating food.
- Plastic boiling bags
For cooking and reheating. They should be pierced before use. The holes allow the steam to escape. This prevents a build-up of pressure from forming and the bag from bursting. There are also special bags available for steam cooking which do not need to be pierced. Please follow instructions given on the packet.
- Roasting bags and tubes
Please follow the manufacturer's instructions.

Microwave operation

 Risk of fire due to metal parts. Metal parts such as metal clips or plastic and paper ties that have wire running through them can heat flammable materials until they burn. Do not use metal clips or plastic and paper ties containing wire.

Tip: Metal tins are less suitable for operating modes which use microwave power because the metal reflects the microwaves. The microwaves only reach the food from above, which extends the baking duration. If you use metal tins, place the tin on the glass tray so that it cannot touch the oven walls. If sparks form, do not reuse the tin for operating modes which use microwave power.

- The **supplied** wire rack is only suitable for cooking processes with the Combi Auto Roast , Combi Conv Bake/Combi Convection Roast , Combi Broil , and Combi Conv Broil  operating modes, as well as for operating modes which do not use microwave power (placed on one level).

- Metal baking tins for baking with the Combi Auto Roast , Combi Conv Bake/Combi Convection Roast , Combi Broil , and Combi Conv Broil  operating modes as well as for operating modes which do not use microwave power
- Aluminum foil trays without lids for defrosting and reheating ready meals: The food is only heated from the top. If you remove the food from the aluminum foil container and transfer it to dishware suitable for use in a microwave oven, the heat distribution will generally be more even.

Using aluminum foil trays and aluminum foil can cause crackling and sparks.

Therefore, place aluminum foil trays on the glass tray and not on the wire rack.

Aluminum foil and aluminum foil trays must not touch the oven cavity walls and must remain at least 2 cm from the walls at all times.

- Metal skewers or clips
The size of the cut of meat must be much larger than the metal skewers and clips.

Unsuitable dishware

Moisture can collect in the hollow spaces on dishware and lids with hollow handles or knobs. When the moisture evaporates, pressure can build up and the item can explode. If the hollow recess is sufficiently ventilated, the item can be used.

Do not use dishware with hollow knobs or handles for cooking.

Do **not** use the following dishware and material:

- Wire racks (including the supplied wire rack) are **not** suitable for use with the Microwave  operating mode.
- Metal containers
- Aluminum foil
Exception: for even defrosting, reheating, or cooking of unevenly shaped cuts of meat, e.g., poultry, small pieces of aluminum foil may be used to cover thin parts for the last few minutes of the process.
- Metal clips or plastic or paper ties containing wire
- Plastic containers where the aluminum lid has not been completely removed
- Crystal glass
- Utensils and dishware with metallic decoration (e.g., gold rims, cobalt blue)
- Dishware with hollow handles
- Plasticware made of melamine
Melamine absorbs microwave energy and gets hot.
When purchasing plasticware, make sure that it is suitable for use in a microwave oven.
- Wooden dishes
Water contained in wood evaporates during the cooking process. This causes the wood to dry and crack.

Microwave operation

Testing dishware

Unsuitable dishware can cause sparks or crackling noises in microwave operation. If you are not sure whether glass, porcelain, or stoneware dishware is suitable, test the dishes.

This test cannot be used to check whether items with hollow knobs or handles are suitable for use.

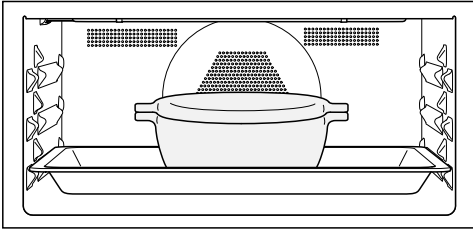

- Place the empty dishware in the middle of the glass tray and insert the tray in shelf level 1.

- Close the door.
- Select the Microwave  operating mode.
- Set the highest microwave power level (level 7) and a cooking duration of 30 seconds.
- Start the process.
- Observe the dishware during the entire duration.
- Immediately open the door if there are sparks or crackling noises.

If there are sparks or if you can hear crackling noises, the tested dishware is not suitable for microwave use.

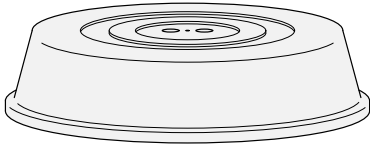

Cover



Tip: Covers are available from retail outlets.

- A cover prevents too much steam escaping, especially when cooking foods which need longer to cook.
 - It speeds up the heating process of the food.
 - It prevents food from drying out.
 - It helps keep the oven cavity clean.
- Use a glass or plastic cover suitable for microwave use for cooking processes with the Microwave  operating mode.





Alternatively, use a cling film suitable for use in a microwave oven. Heat can cause normal cling film to distort and fuse with the food.

The cover can withstand temperatures of up to 230°F (110°C). At higher temperatures (e.g., in the Maxi Broil  or Convection Bake/Convection Roast  functions), the plastic may distort and fuse with the food.

Only use a cover for the Microwave  operating mode.

The cover should not form a seal with the container. If the container has a narrow diameter, the steam may not be able to escape. The cover could get too hot and start to melt.

Use containers with a sufficiently large diameter.

- Do **not** use a cover for reheating the following types of food:
- food coated in breadcrumbs
 - food which requires a crisp finish, e.g. toast
 - food which is to be heated with the Combi Auto Roast , Combi Conv Bake/Combi Convection Roast , Combi Broil , or Combi Conv Broil  operating modes

Operation

If you place food directly on the floor of the oven when using the Microwave  operating mode, the oven can become damaged.

When using the Microwave  operating mode, place the glass tray on level 1 and **always** place containers such as cups and baking tins on the glass tray.



- Turn the oven on.

The main menu will appear.

- Place the food in the oven cavity.
- Select the operating mode you want to use.

The operating mode will appear first. Depending on the function, the recommended temperature, recommended power level, and the cooking duration will appear one after the other in the display.

- Change the recommended values for the cooking process and set the cooking duration if required.

You can subsequently change the temperature via the navigation area, the microwave power level via the /≈ sensor button, and the cooking duration via the  sensor button.

- Confirm each entry with *OK*.
Confirming the temperature starts the cooking process for operating modes which **do not use** microwave power.

For operating modes **which do use** microwave power, the set microwave power level and the set cooking duration appear in the display.

- Use the *OK* sensor button to start the cooking process for operating modes **which do use** microwave power.

The cooking process starts.

If you have set a temperature, you will see the temperature increasing. An audible signal will sound when the set temperature is reached for the first time.

The oven stops generating microwave power when you interrupt the cooking process or open the door. You can continue the cooking process with the *OK* sensor button.

- After cooking, select the sensor button for the selected operating mode to end the cooking process.
- Take the food out of the oven cavity.
- Turn the oven off.



Changing values and settings for a cooking program

Depending on the operating mode, as soon as a cooking program is in progress, you can change the values or settings for this program.

Depending on the operating mode, you can change the following settings:

- Temperature
- Power level
- Duration
- Finish at
- Start at

Changing the temperature

You can permanently reset the recommended temperature to suit your cooking preferences by selecting More  | Settings  | Recommended temps..

- Select the \wedge or \vee arrow buttons or swipe to the right or left in the  area.

The desired temperature appears in the display.

- Change the desired temperature via the navigation area.



The temperature changes in 5° steps.

- Confirm with *OK*.

The cooking program will restart with the new desired temperature.

Changing the microwave power level

You can change the microwave power level in the Microwave  operating mode and in operating modes which use microwave power.

You can permanently reset the default power level to suit your cooking preferences by selecting More  | Settings  | Rec. power levels.

- Select the  \approx sensor button.

The set microwave power level will appear in the display.

- Change the microwave power level via the navigation area.

You can select a microwave power level from 1 through 7.

- Confirm with *OK*.

The cooking process continues to run with the modified microwave power level.

Operation

Setting additional durations

Cooking results can be adversely affected if there is a long delay between the food being placed in the oven and the start of cooking. Fresh food can change color and even spoil.



When baking, the cake mixture or dough can dry out, and the raising agents can lose their effectiveness.

Select as short a time as possible until the start of the cooking process.

You have placed the food in the oven, selected a mode and the required settings such as the temperature.

By entering **Duration**, **Finish at**, or **Start at** via the  sensor button, you can automatically turn the cooking program off or on and off.

- **Duration**
Enter the required cooking duration for the food. The oven heating will turn off automatically once the cooking duration has elapsed. The maximum cooking duration that can be set depends on the mode that you have selected.
- **Finish at**
Specify when you want the cooking program to finish. The oven will turn off automatically at the time you have set.
- **Start at**
This function will only appear in the menu if you have set a **Duration** or **Finish at** time. With **Start at**, you have to specify when you want the cooking program to start. The oven will turn on automatically at the time you have set.

- Select the  sensor button.
- Set the required times.
- Confirm with **OK**.
- Touch the  sensor button to return to the menu of the selected mode.

Changing set cooking durations

- Select the  sensor button.
- Select the time you want.
- Confirm with **OK**.
- Select **Change**.

This menu option does not appear if you want to change the cooking duration for operating modes **which use** microwave power, as these functions always require a set cooking duration.

The time will be highlighted.



- Change the set time.
- Confirm with **OK**.
- Touch the  sensor button to return to the menu of the selected operating mode.
- Use the **OK** sensor button to continue the cooking process for operating modes **which use** microwave power.

These settings will be deleted in the event of a power failure.

Tip: You can also change the cooking duration for the **Microwave**  operating mode via the navigation area.

Deleting the set cooking durations

For an operating mode **which uses** microwave power, you can only delete the set times for *Finish at* and *Start at*. The cooking duration must always be set.

- Select the  sensor button.
- Select the time you want.
- Confirm with *OK*.
- Select *Delete*.
- Confirm with *OK*.
- Touch the  sensor button to return to the menu of the selected operating mode.

If you delete *Duration* for an operating mode which **does not use** microwave power, the set times for *Finish at* and *Start at* are also deleted.

If you delete *Finish at* or *Start at*, the cooking process will start using the cooking duration set.

Interrupting a cooking process in the Microwave operating mode

You can interrupt a cooking process when using the *Microwave*  operating mode and pause the cooking duration.

During cooking, the *OK* sensor button lights up.

- Select the *OK* sensor button.

The cooking process is interrupted and the cooking duration is paused.

The *OK* sensor button lights up.

- Select the *OK* sensor button.

The cooking process resumes and the cooking duration continues to count down.

Canceling a cooking program

- Touch the sensor button for the selected operating mode or the  sensor button.
- When *Cancel process* appears in the display, confirm with *OK*.

The oven heating and lighting will then turn off. Any cooking durations set will be deleted.

The main menu will appear.

Operation

Preheating the oven



The **Booster** function is used to quickly preheat the oven cavity in some operating modes.





The oven cavity only needs to be preheated in a few cases.

- You can place most dishes in the cold oven cavity to make use of the heat produced during the heating-up phase.
- For dark bread dough as well as roast beef and fillets, preheat the oven cavity when using the **Convection Bake/Convection Roast**  operating mode.

Booster

The **Booster** function is used to quickly preheat the oven.

This function is switched on as the factory default setting for the following operating modes (**More**  | **Settings**  | **Booster** | **On**):

- Convection Bake 
- Convection Roast 
- Auto Roast 
- Combi Conv Bake 
- Combi Convection Roast 

If you set a temperature above 210°F (100°C) and the **Booster** function is turned on, a rapid heating-up phase heats the oven cavity to the set temperature. The broiling element and ring heater element come on together with the blower.

Delicate items (e.g., sponge or cookies) will brown too quickly on the top if the **Booster** function is used.

Turn off the **Booster** function for these items.

Turning Booster off for a cooking program

- Select the **Booster** | **Off** setting before selecting the desired operating mode.

The **Booster** function is turned off during the preheating phase. Only the heating elements for the selected operating mode are used to preheat the oven compartment.

If you then want to restart a cooking program with the **Booster** function, select the **Booster** | **On** setting to switch the function on again.

These functions can only be used when no other cooking processes are in use.

Always use the glass tray.

Quick MW

If you select the  sensor button, the oven starts with a set microwave power level and cooking duration, e.g., to reheat a drink.

The maximum microwave power level of 7 and a cooking duration of 1 minute are preset.

You can change the microwave power level and the cooking duration. The maximum cooking duration that can be set depends on the microwave power level selected (see section “Settings – Quick MW”).

- Select the  sensor button.
Touching it repeatedly increases the cooking duration in increments.

The time left will appear in the display.

You can interrupt and resume the cooking process at any time by touching the **OK** sensor button or cancel it with the  sensor button.

At the end of the cooking process, **Finished** appears in the display and an audible signal sounds.

- Select the  sensor button.

The main menu will appear.

Popcorn

If you select the  sensor button, the oven starts with a set microwave power level and cooking duration, e.g., to reheat a drink.

Microwave power level 6 and a cooking duration of 2:50 minutes are preset. These settings match the manufacturer’s instructions on most bags of microwave popcorn.

The maximum cooking duration that can be set is 4 minutes. The microwave power level is set and cannot be modified (see section “Settings – Popcorn”).

- Select the  sensor button.

The time left will appear in the display.

You can interrupt and resume the cooking process at any time by touching the **OK** sensor button or cancel it with the  sensor button.

Disposable containers made out of paper or other flammable materials can ignite, causing damage to the oven.

Do not leave the oven unattended during the cooking process and make sure you follow the instructions on the packaging.

At the end of the cooking process, **Finished** appears in the display and an audible signal sounds.

- Select the  sensor button.

The main menu will appear.

Automatic programs

With the wide range of automatic programs, you can achieve excellent results with ease.

Categories

The automatic programs  are sorted into categories to provide a better overview. Simply select the appropriate automatic program for the type of food you are cooking and follow the instructions on the display.

Using automatic programs

- Select Automatic programs .

A list will appear.

- Select the food category you want.

The automatic programs available for the category selected will then appear.

- Select the automatic program that you want to use.
- Follow the instructions on the display.

Usage notes

- After cooking, allow the oven compartment to cool down to room temperature again before starting a automatic program.
- Some automatic programs require a preheating phase before food can be placed in the oven. A prompt will appear on the display indicating when this needs to be done.
- Some automatic programs require liquid to be added during the cooking process. You will be prompted by a message on the display when this needs to be done (e.g., for adding liquid).
- The duration quoted for automatic programs is an estimate. It may increase or decrease depending on the program. The duration, in particular with meat, will vary depending on the initial temperature of the food.

Additional applications

This section provides information on the following applications:



- Defrost
- Dehydrating
- Reheat
- Cooking
- Canning
- Frozen food/ready meals

Additional applications

Defrost

Gentle defrosting of frozen food means that the vitamins and minerals are generally retained.

■ Use one of the following operating modes:

- Defrost  operating mode
Set the defrosting temperature.
- Microwave  operating mode
Set the microwave power level and defrosting duration.

Always observe USDA/CFIA food safety guidelines.



Risk of infection from bacteria.

Bacteria such as salmonella can cause life-threatening food poisoning. It is particularly important to observe food hygiene rules when defrosting fish and meat, and in particular when defrosting poultry.

Do not use the liquid produced during defrosting.

Process the food as required as soon as it has been defrosted.

Tips

- Place the food to be defrosted on the glass tray without its packaging.
- For defrosting poultry, use the glass tray with the wire rack placed on top of it. This way the frozen food will not be lying in the defrosted liquid.
- Meat, poultry, or fish does not need to be fully defrosted before cooking. Defrost until the food has started to thaw. The surface will then be sufficiently thawed to take herbs and seasoning.

Using the Defrost operating mode

This operating mode was developed to gently defrost frozen food.

- Select Defrost .
- Alter the recommended temperature if necessary.

Air is circulated throughout the oven cavity to gently defrost the frozen food.

Using the Microwave operating mode

Alternatively, you can use the Microwave  operating mode for defrosting. Set the microwave power level and the defrosting duration.



The time required depends on the nature of the food, its initial temperature, and the amount to be cooked. Take note of the standing times.

Only use dishware that is microwave safe.

- Select Microwave .
- Depending on the type of food, set the microwave power level and the defrosting duration specified in the chart.
- In general you are advised to select the middle duration.
- Place the food on the glass tray on shelf level 1 in the oven cavity.

Additional applications

Defrosting with the Microwave operating mode

Food to be defrosted	Quantity		 [min]	 [min]
Butter	1/2 lb (250 g)	1	8–10	5–10
Milk	4 1/4 c (1000 ml)	4	12–16	10–15
Sponge cake (3 slices)	Approx. 0.6 lb (300 g)	2	4–6	5–10
Fruit cake (3 slices)	Approx. 0.6 lb (300 g)	2	6–8	10–15
Butter cake (3 slices)	Approx. 0.6 lb (300 g)	2	6–8	5–10
Cream cake (3 slices)	Approx. 0.6 lb (300 g)	1	4–4:30	5–10
Yeast rolls, puff pastries (3 pieces)	Approx. 0.6 lb (300 g)	2	6–8	5–10

 Microwave power level,  defrosting time,  standing time

¹ Allow food to stand at room temperature. This standing time allows the heat to spread evenly throughout the food.

Additional applications





Dehydrate

Dehydrating or drying is a traditional method of preserving fruit, certain vegetables, and herbs.

It is important to check that fruit and vegetables are fresh, ripe and unbruised before they are dehydrated.

- Prepare the food for drying by cutting it up, and peeling and coring it if necessary.
- Depending on how big it is, distribute the food for drying as evenly as possible over the rack or glass tray in a single layer.
- Dry on a maximum of 2 levels at the same time.
Place the food for drying on shelf levels 1+2.
If you are using both the rack and glass tray, insert the glass tray below the rack.
- Select Convection Bake .
- Alter the recommended temperature and then set the time.
- Turn the food being dried on the glass tray at regular intervals.

The drying times are longer for whole or halved food.

Food for drying		°F [°C]	⌚ [h]
Fruit		140-160 (60-70)	2-8
Vegetables		130-150 (55-65)	4-12
Mushrooms		115-125 (45-50)	5-10

 operating mode,  temperature,  drying time,  Convection Bake

- Reduce the temperature if condensation begins to form in the oven.

Removing the dried food

 Risk of injury caused by hot surfaces.

The oven gets hot during operation. You could burn yourself on the heating elements, oven compartment, or accessories. Use pot holders when removing the food from the oven.

- Allow the fruit or vegetables to cool down after dehydrating.

Dried fruit must be completely dry, but also soft and elastic. Juice should not escape when cut.

- Store dried food in sealed glass jars or cans.

Reheat

It is essential that the information in “IMPORTANT SAFETY INSTRUCTIONS – Correct use” is observed.

 Danger of injury caused by hot food.

If food for babies and children is heated at too high a temperature, they can burn themselves.

Only heat food for babies and children for 30–60 seconds at microwave power level 4.

After heating food, especially food for babies and small children, stir the food or shake the container and taste the food so that children do not get burned.

 Danger of injury from increased pressure in sealed containers or bottles.

Pressure can build up during reheating in sealed containers or bottles, causing them to explode.

Never cook or reheat food or liquids in sealed containers or bottles. Open containers beforehand and with baby bottles, the screw top and teat must be removed.

Danger of injury caused by hot liquids.

When heating food, and in particular liquids, using the

Microwave  operating mode, the boiling point may be reached without the typical bubbles being produced. The liquid does not boil evenly throughout.

This boiling delay can result in the liquid boiling over explosively. Take care when taking the container out of the oven, as the hot liquid can cause severe scalding. Under certain circumstances, the pressure can be so high that the door opens automatically.

Stir liquids well before heating or cooking.

After heating, wait at least 20 seconds before removing the container from the oven.

In addition, you can place a glass rod or similar item, if available, in the container during the heating process.

Additional applications

Using the Microwave operating mode

The Microwave  operating mode is ideal for reheating.

The time required depends on the nature of the food, its initial temperature, and the amount to be cooked. For example, food taken straight from the refrigerator takes longer to reheat than food which has been kept at room temperature. Take note of the standing times.

Only use dishware that is microwave safe.

Always cover food when reheating it, except when reheating meat/fish coated in breadcrumbs.

- Place the food that is to be reheated on the glass tray with a cover.
- Place the glass tray on shelf level 1 in the oven cavity.
- Select Microwave .
- Depending on the type of food, set a microwave power level and a cooking duration.
You can find the values for some types of food in the chart.
- Turn, separate, or stir the food several times. Stir the food from the outside towards the middle, as food heats more quickly from the outside.

 Danger of burning due to hot surfaces.

The oven gets hot during operation. You could burn yourself on the heater elements, oven cavity, or accessories. Condensation may accumulate on the bottom of the dishware.



Use pot holders when working in the hot oven cavity and when removing the dishware.

During the standing time, the temperature is distributed evenly in the food.

- After reheating, allow the food to stand at room temperature for a few minutes to enable the heat to spread evenly throughout the food.

Additional applications

Reheating with the Microwave operating mode

Drink/ Food	Quantity		 [min]	 ¹ [min]
Drinks (drinking temperature 140-150°F (60-65°C))	1 cup/1 glass (8 oz/200 ml)	7	00:50-1:10	-
Baby bottle (milk) ²	Approx. 8 oz (200 ml)	4	00:50-1:00 ³	1
Food for babies and children ³	1 jar (8 oz/200 g)	4	00:30-1:00	1
Sliced meat with sauce ³	8 oz (200 g)	5	3:00-5:00	1
Side dishes ³	1/2 lb (250 g)	5	3:00-5:00	1

 Microwave power level,  cooking duration,  standing time

- ¹ Allow food to stand at room temperature. This standing time allows the heat to spread evenly throughout the food.
- ² A boiling delay can be avoided by stirring liquids before reheating them. After heating, wait at least 20 seconds before removing the container from the oven. In addition, you can place a glass rod or similar item, if available, in the container during the heating process.
- ³ The durations apply to food with an initial temperature of approx. 40°F (5°C).
For food not normally refrigerated, durations apply to food at room temperature of approx. 105°F (20°C).
With the exception of baby food and delicate whisked sauces, food should be heated to a temperature of 155-165°F (70-75°C).

Additional applications

Cooking

It is essential that the information in “IMPORTANT SAFETY INSTRUCTIONS – Correct use” is observed.



Food with a thick skin or peel, such as tomatoes, sausages, potatoes, and eggplant can burst when heated or cooked.

Pierce or score the skin of these foods several times to allow steam to escape.

Eggs heated in their shell can burst, even after they have been removed from the oven.





Eggs can only be cooked in their shells in a specially designed egg-boiling device. Do not reheat hard-boiled eggs using the Microwave  operating mode.

Tips

- Turn, separate, or stir the food several times. Stir the food from the outside towards the middle, as food heats more quickly from the outside.
- Use only dishware that is suitable for use in a microwave and oven when using operating modes which use microwave power.
- If possible, use MasterChef for cooking.
- Never use a lid with the Combi Conv Broil  and Combi Broil  operating modes, as the food will not brown.
- Select microwave power level 6 in the Microwave  operating mode to start cooking and then continue cooking at power level 4.

Additional applications

Cooking with the Microwave operating mode

Soups/stews Vegetables	 [g]	Level 6  [min]	+	Level 4  [min]	 ¹ [min]
Stew	1500	10	+	20	1
Soup	1500	11	+	24	1
Peas	500	5	+	10	2
Peas (frozen)	450	5	+	12	2
Carrots	500	5	+	10	2
Broccoli florets	500	6	+	8	2
Broccoli (frozen)	450	5	+	11	2
Cauliflower florets	500	6	+	10	2
Kohlrabi batons	500	3	+	8	2
Asparagus	500	5	+	8	2
Leeks	500	5	+	8	2
Leeks (frozen)	450	5	+	8	2
Peppers, cut into strips	500	5	+	10	2
Beans, green	500	4	+	12	2
Brussels sprouts	500	5	+	12	2
Brussels sprouts (frozen)	450	5	+	10	2
Mixed vegetables (frozen)	450	5	+	12	2

 Weight,  cooking duration,  standing time

¹ Allow food to stand at room temperature. This standing time allows the heat to spread evenly throughout the food.

Additional applications

Canning

 Risk of infection from bacteria. The spores of the botulinum bacterium are not sufficiently killed by canning legumes and meat only once. Toxins may form which can lead to serious poisoning. These spores are only destroyed by canning the food again.

After they have cooled down, **always** reheat legumes and meat a second time within 2 days.

 Risk of injury from increased pressure in sealed cans.

Canning food and heating it up in closed containers results in an increase in pressure which can cause them to explode.

Do not use cans for canning or reheating food.

Always observe USDA/CFIA food safety guidelines.

Preparing fruit and vegetables

The instructions are for a maximum of 5 jars with a capacity of 4 cups (0.5 l) each.

Only use special jars, which you can find in specialist dealers:

- Convection Bake : Bottling jars with a screw cap
- Microwave : Microwave-safe bottling jars with glass lids, sealed with clear adhesive tape

- Only use undamaged jars and rubber rings.
- Rinse the jars with hot water before canning and fill them up to a maximum of 3/4" (2 cm) below the rim.
- Seal the jars with clear adhesive tape. Do not use any metal clips as they cause sparks when used with the Microwave  operating mode.
- Insert the glass tray on shelf level 1 and place the jars on it.

Additional applications

Using the Convection

Bake operating mode

- Select the Convection Bake  operating mode and a temperature of 320-340°F (160-170°C).
- Wait until bubbles rise evenly in the jars.



Then reduce the temperature to prevent the contents from boiling over.

Canning fruit and vegetables

- Set the specified post-canning warming temperature as soon as bubbles are visible in the jars, then leave the jars in the warm oven for the time specified.

Canning vegetables

- As soon as bubbles are visible in the jars, set the specified preserving temperature and cook the vegetables for the time specified.
- After canning, set the specified post-canning warming temperature, then leave the jars in the warm oven for the time specified.

		
Fruit	-/-	85°F (30°C) 25-35 min
Pickling cucumbers	-/-	85°F (30°C) 25-30 min
Beets	250°F (120°C) 30-40 min	85°F (30°C) 25-30 min
Beans (green or yellow)	250°F (120°C) 90-120 min	85°F (30°C) 25-30 min

 Canning temperature and time once bubbles are visible in the jars

 Post-canning warming temperature and time

Using the

Microwave operating mode

- Select the Microwave  operating mode and microwave power level 6.
- Wait until bubbles rise evenly in the jars. This takes about 3 minutes per jar. With 5 jars, therefore, it takes 15 minutes.

Then reduce the microwave power level to prevent the contents from boiling over.



Canning fruit and vegetables



- Switch the oven off as soon as bubbles are visible in the jars. Then leave the jars in the warm oven cavity for the time specified.

Additional applications

Canning vegetables

- As soon as bubbles are visible in the jars, set the specified microwave power level and cook the vegetables for the time specified.
- Switch the oven off after bottling and then leave the jars in the warm oven cavity for the time specified.

	 / 	
Fruit	-/-	25–35 min
Pickling cucumbers	-/-	25–30 min
Beets	Level 4 20–30 min	25–30 min
Beans (green or yellow)	Level 4 20–30 min	25–30 min

 /  Microwave power level and bottling time, as soon as bubbles are visible

 Continued warming time

Removing the jars after canning

 Risk of injury caused by hot surfaces.

The jars will be very hot after canning.

Use oven mitts when removing the jars from the oven.

- Take the jars out of the oven.
- Cover the jars with a towel and leave to set for approx. 24 hours in a draft-free area.
- After they have cooled down, **always** reheat beans and meat a second time within 2 days.
- Remove the fasteners from the jars and make sure all jars are closed properly when storing them.

Either boil open jars again or store them in a cool place and consume the preserved fruit or vegetables immediately.

- Check the jars during storage. If jars have opened during storage or if the screw cap is bulging and does not make a popping noise when opened, dispose of the contents.

Frozen food/ready meals

Tips for cakes, pizza, and baguettes

- Bake cakes, pizza, and baguettes on parchment paper on the wire rack.
- Use the lowest temperature recommended by the manufacturer.

Tips for French fries, croquettes, and similar items

- Bake these frozen products on parchment paper on the glass tray.
- Use the lowest temperature recommended by the manufacturer.
- Turn several times during cooking.

Preparing frozen food/ready meals

Handling and cooking food correctly is essential for maintaining good health.

Cakes, pizzas, and French fries should be cooked until golden, not dark brown.

- Select the operating mode and temperatures recommended on the food's packaging.
- Preheat the oven.
- Place the food in the preheated oven on the shelf level recommended on the packaging.
- Check the food at the end of the shortest time recommended on the packaging.

Warm-up Cookware

Use the Convection Bake  operating mode for preheating dishware.

Only preheat heat-resistant dishware.

- Place the wire rack on shelf level 1 and place the dishware to be preheated on it. Depending on the size of the dishware, you can also place the wire rack on the oven floor and take the side racks out to make more room.
- Select Convection Bake .
- Set the temperature to 120-175°F (50-80°C).

 Danger of burning!

Use pot holders when removing dishware. Condensation may accumulate on the bottom of the dishware.

- Remove the heated dishware from the oven.

Baking

Handling and cooking food correctly is essential for maintaining good health.

Cakes, pizzas, and French fries should be cooked until golden, not dark brown.

Always observe USDA/CFIA food safety guidelines.

Tips for baking

- Set a cooking duration. If used for baking, do not delay the start for too long. Otherwise the cake mixture or dough will dry out, and the raising agents will lose their effectiveness.
- Avoid using bright, thin-walled pans made from a shiny material as they give an uneven or poor browning result. In certain unfavorable conditions, the food will not cook properly.
- Place cakes in rectangular bakeware on the wire rack with the longer side across the width of the oven for optimum heat distribution and even results.
- Line the glass tray with parchment paper before placing chips, croquettes, and similar types of food on it.

Selecting the temperature

- Select the suggested temperature in general.

Choosing a baking temperature higher than those recommended may reduce the cooking time, but will lead to uneven browning and unsatisfactory cooking results.

Selecting the cooking duration

- Check whether the food is cooked shortly before the end of the specified cooking duration. Stick a wooden skewer into the food.

If it comes out clean without any batter/dough on it, the food is done.

Notes on the operating modes

You can find an overview of all the operating modes with their recommended values in “Main and submenus”.

Using Automatic programs

- Follow the instructions on the display.

Using Convection Bake

You can use any type of bakeware made of heat-resistant material.

Use this operating mode if you are baking on multiple shelf levels at the same time.

- 1 shelf level: place cakes in baking tins on shelf level 1.
- 1 shelf level: place flat items (e.g., cookies, tray cakes) on shelf level 2.
- 2 shelf levels: depending on the height, place the food on shelf levels 1+3 or 2+3.

Using Combi Conv Bake

Use heat-resistant baking tins suitable for microwave use (see “Microwave operation – Suitable dishware”), such as heat-resistant glass or ceramic dishes, as these allow microwaves through them.

The Combi Conv Bake  operating mode is particularly suitable for baking dough which requires a longer cooking duration, such as rubbed in, beaten mixtures and yeast recipes.

If you use this operating mode, the cooking duration is shortened.

- Place the glass tray on shelf level 1.
- Place the baking tin on the glass tray.

Tip: Metal tins are less suitable for operating modes which use microwave power because the metal reflects the microwaves. The microwaves only reach the cake from above, which extends the cooking duration. If you use metal tins, place the tin on the glass tray so that it cannot touch the oven walls. If sparks form, do not reuse the tin for operating modes which use microwave power.

Roasting

Tips for roasting

- **Preheating** the oven is only required when roasting beef sirloin and fillet. Preheating is generally not necessary.
- Use a **closed cooking container** for roasting meat, such as a roasting dish. The meat will stay succulent. The oven cavity will also stay cleaner than when roasting on the wire rack. It ensures that enough stock remains for making gravy.
- If you are using a **roasting bag**, follow the instructions on the packaging.
- If you are using the **wire rack** or an **open cooking container** for roasting, you can add a little fat or oil to very lean meat or place a few strips of streaky bacon on the top.
- **Season** the meat and place in the cooking container. Dot with butter or brush with oil or cooking fat. For large lean cuts of meat (4.5–6.5 lbs/2–3 kg) and fatty poultry, add about 1/2 cup (1/8 liter) of water to the dish.
- Do not add too much liquid during cooking as this will hinder the **browning** process. Browning only occurs towards the end of the cooking duration. Remove the lid about halfway through the cooking duration if you want a more intensive browning result.
- At the end of the program, take the food out of the oven, cover it, and leave to **stand** for about 10 minutes. This helps retain the juices when the meat is sliced.

- For a crisp finish, baste **poultry** 10 minutes before the end of the cooking duration with slightly salted water.

Selecting the 🌡️ temperature

- As a general rule, select the temperature given in the corresponding recipe.
- For large pieces of meat, do not choose a temperature that is too high. The roasting process will take longer, but the meat will cook through evenly and the skin or crackling will not be too thick.

Selecting the 🕒 cooking duration

- Check whether the food is cooked shortly before the end of the specified cooking duration.

Tips

- For frozen meat, increase the cooking duration by approx. 10 minutes per lb (20 minutes per kg).
- Frozen meat weighing less than approx. 3.3 lb (1.5 kg) does not need to be defrosted before roasting.

Notes on the operating modes

You can find an overview of all the operating modes with their recommended values in “Main and submenus”.

Using Automatic programs

- Follow the instructions on the display.

Using Convection Roast or Auto Roast

These operating modes are suitable for roasting meat, fish, and poultry that needs to be well browned, as well as roast beef and fillet.

With the Auto Roast  operating mode, the oven cavity initially heats to the highest temperature in this operating mode for searing. As soon as this temperature has been reached, the oven automatically drops the temperature back down to the preselected cooking temperature (continued roasting temperature).

- For roasting, use dishware with heat-resistant handles such as an oven dish, roasting pan, terracotta dish, or a heat-resistant glass dish.
- Place the wire rack with the food on shelf level 1.

Using Combi Convection Roast or Combi Auto Roast

These operating modes are **not** suitable for roasting delicate cuts of meat such as sirloin joints or fillet. The center would be too well cooked before the exterior is browned.

Use the Combi Convection Roast  operating mode for rapid reheating and cooking of food while browning it at the same time. This operating mode saves the most time and energy.

Use the Combi Auto Roast  operating mode for searing using a high temperature to start with, then continue cooking with a lower temperature.

If you use operating modes which use microwave power, the cooking duration is shortened.

- Dishware must be suitable for use in a microwave oven, must be heat-resistant, and must not have metal lids (see “Microwave operation – Suitable dishware”).
- Place the wire rack together with the glass tray or the glass tray on shelf level 1.

Broiling

 Risk of injury caused by hot surfaces.

If you broil with the door open, the hot air will escape from the oven before it has been cooled by the cooling fan. The control elements will get hot.



Broil with the oven door closed.

Always observe USDA/CFIA food safety guidelines.

Tips for broiling

- Preheating is necessary when broiling. For preheating, select an operating mode which **does not use** microwave power.
Preheat the broiling element for approx. 5 minutes with the door closed.
- Quickly rinse meat under cold running water and pat dry. Do not season the meat with salt before broiling, as this will draw out the juices.
- Add a little oil to lean meat if necessary. Do not use other types of fat as they can easily burn and cause smoke.
- Clean fish in the normal way. To enhance the flavor, season with a little salt. You can also drizzle the fish with lemon juice.
- It is generally best to broil on the wire rack.
- To broil, brush the wire rack with oil and then place the food on the wire rack.

Selecting the temperature



Select the temperature for the Convection Broil  and Combi Conv Broil  operating modes.

- As a general rule, select the lower temperature given in the chart. If higher temperatures are used than those specified, the meat will brown on the outside, but will not be properly cooked through.

Selecting the broiling setting

Select between levels 1–3 for the Maxi Broil  and Combi Broil  operating modes.

- If you are broiling thicker foods further away from the broiling element, select **level 1**.
- If you desire a lighter, golden finish, on gratins for example, select **level 2**.
- If you are quickly broiling thinner foods closer to the broiling element, select **level 3**.

Set the microwave power level , the broiling level , and the cooking duration.

Selecting the cooking duration

- Broil thinner cuts of meat/slices of fish for approx. 6–8 minutes per side. It is best to broil food of a similar thickness at the same time so that the cooking durations do not vary too much.
- Broil thicker pieces for about 7–9 minutes per side.
- When broiling rolled meat, allow approx. 10 minutes per 1/2" (1cm) diameter.
- Check whether the food is cooked shortly before the end of the specified cooking duration.

Tip: If the surface of a thicker cut of meat is browned but the center is still raw, move the food to a lower level or reduce the temperature and continue broiling. This will stop the surface from becoming too dark.

Notes on the operating modes

You can find an overview of all the operating modes with their recommended values in “Main and submenus”.

If you use operating modes which use microwave power, the cooking duration is shortened.

Using Convection Broil or Combi Conv Broil

These operating modes are suitable for broiling thicker food, such as chicken.

We generally recommend a temperature setting of 425°F (220°C) for thinner types of food and 350–400°F (180–200°C) for thicker cuts.

- Place the wire rack on shelf level 1 or 2 depending on the height of the food.

Using Maxi Broil or Combi Broil

These operating modes are suitable for broiling thin cuts of meat and browning food.

- Place the wire rack on shelf level 2 or 3 depending on the height of the food.

Cleaning and care of the oven

 Danger of injury caused by hot surfaces.

The oven gets hot during operation. You could burn yourself on the heater elements, oven cavity, or accessories.

Allow the heater elements, oven cavity, and accessories to cool before manual cleaning.

 Risk of injury due to electric shock.

The steam from a steam cleaning appliance could reach live electrical components and cause a short circuit.

Never use a steam cleaner for cleaning.

All surfaces could be discolored or damaged if unsuitable cleaning agents are used. The oven front is particularly susceptible to damage from oven cleaners.

All surfaces are susceptible to scratching. Scratches on glass can lead to breakage in some circumstances.

Remove all cleaning agent residues immediately.

Stubborn soiling may damage the oven.

Once the oven has cooled, clean the oven cavity, the inside of the door, and the door seal. Waiting too long to clean the oven will make it much more difficult to clean.

Operating a damaged oven can result in microwave leakage and present a hazard to the user.

Check the door and door seal for any sign of damage. If any damage is seen, the oven should not be used again. Contact Miele.

Unsuitable cleaning agents

To avoid damaging the surfaces of your appliance, do not use:

- cleaning agents containing soda, ammonia, acids, or chlorides
- cleaning agents containing descaling agents on the front
- abrasive cleaning agents (e.g., powder cleaners and cream cleaners)
- solvent-based cleaning agents
- stainless steel cleaning agents
- dishwasher cleaners
- glass cleaners
- cleaning agents for ceramic glass cooktops
- hard, abrasive brushes or sponges (e.g., pot scourers, brushes, or sponges which have been previously used with abrasive cleaning agents)
- eraser sponges
- sharp metal scrapers
- steel wool
- spot cleaning with mechanical cleaning agents
- stainless steel spiral pads

Cleaning and care of the oven

If soiling is allowed to sit for any length of time, it may become impossible to remove. If items are used frequently without being cleaned, it may become very difficult to clean them.

It is therefore best to remove any soiling immediately.

Only the glass tray is dishwasher proof.

Tip: Soiling caused by spilled fruit juices and cake mixtures is best removed while the oven is still warm. Use caution and make sure the oven is not too hot.

To make it easier to clean the oven:

- Lower the broiling element.
- To neutralize odors in the oven cavity, put a container of water with some lemon juice in the oven and heat for a few minutes.

Removing normal soiling

Moisture inside the oven can cause damage.

Do not use too much water on the cloth or sponge and do not let water or any other liquid find its way into any oven cavity openings.

- Remove normal soiling immediately with warm water, liquid dish soap, and a clean sponge or a clean, damp microfiber cloth.
- Remove all cleaning agent residues thoroughly with clean water. This is particularly important for any parts with a PerfectClean finish, as cleaning agent residues will impair the non-stick function.
- After cleaning, wipe the surfaces dry using a soft cloth.

Cleaning and care of the oven

Removing stubborn soiling

Spilt fruit and roasting juices may cause lasting discoloration or matte patches on surfaces. This discoloration will not affect the properties of the surface finish. Do not attempt to remove these stains. Clean them following the instructions given here.

- Moisten stubborn soiling with a solution of hot water and washing-up liquid and leave to soak for a few minutes.
- If necessary, the scouring pad on the back of a washing-up sponge can be used to remove the soiling after the soaking time.

Using oven cleaners

- Very stubborn soiling on PerfectClean surfaces can be cleaned using Miele Oven Cleaner. This cleaner must only be applied to cold surfaces.

If the oven spray gets into gaps and openings, a strong odor is generated during subsequent cooking processes.

Do not spray the oven cleaner onto the ceiling of the oven.

Do not spray the oven cleaner into the gaps and openings of the oven cavity walls and rear wall.

- Leave the oven cleaner to work according to the instructions on the packaging.

Oven cleaners from other manufacturers must only be used in a cold oven and not left on for longer than a maximum of 10 minutes.

- If necessary, you can use the scouring pad on the back of a non-scratching dish sponge to remove the soiling after the holding time.
- Remove all cleaning agent residues thoroughly with clean water.
- Dry all surfaces with a soft cloth.

Cleaning and care of the oven

Lowering the broiling element

If the ceiling of the oven is badly soiled, the broiling element can be lowered to make cleaning easier. Clean the ceiling of the oven regularly with a damp cloth or a dish sponge.

⚠ Danger of injury caused by hot surfaces.

The oven gets hot during operation. You could burn yourself on the heater elements, oven cavity, or accessories.

Allow the heater elements, oven cavity, and accessories to cool before manual cleaning.

The oven cavity floor can be scratched by the falling nut. Place a cloth or similar item over the oven floor to protect it.

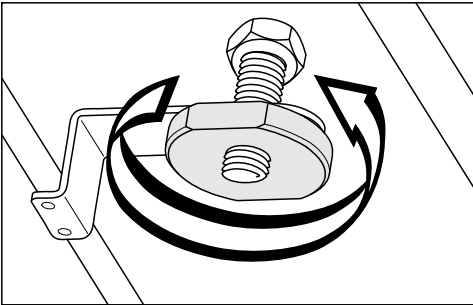

- Unscrew the nut.

The broiling element can be damaged. Never use force to lower the broiling element.

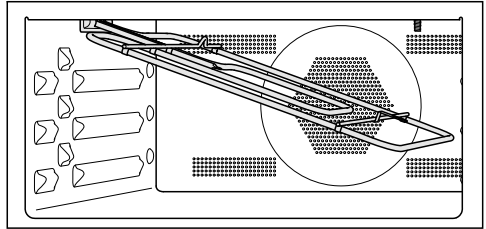

- Lower the broiling element carefully.

The liner on the ceiling of the oven can be damaged.

Do not use the abrasive side of the dishwashing sponge to clean the ceiling of the oven.

The LED on the ceiling of the oven can be damaged.

Do not clean the LED if possible.



- Clean the ceiling of the oven with a damp cloth or a soft sponge.
- After cleaning the broiling element, raise it gently back up again.
- Replace the nut and tighten it securely.

Frequently asked questions

Many malfunctions and faults that can occur in daily operation can be easily remedied. You can save time and money in many cases, as you do not need to contact Miele Customer Service.

Information to help you rectify faults yourself can be found at www.miele.com/service.



The following tables are designed to help you to find the cause of a malfunction or a fault and to resolve it.

Problem	Possible cause and solution
The display is dark.	<p>You have selected the Time Display Off setting. When the oven is turned off, the time-of-day display is turned off.</p> <ul style="list-style-type: none"> ■ As soon as the oven is turned on, the main menu will appear. If you want the time of day to be displayed constantly, select the Time Display On setting. <hr/> <p>There is no power to the oven.</p> <ul style="list-style-type: none"> ■ Check if the breaker has tripped. If it has, contact a qualified electrician or Miele Customer Service.
The audible signal does not sound.	<p>The audible signals are deactivated or set at too low a volume.</p> <ul style="list-style-type: none"> ■ Turn on the audible signals or increase the volume with Volume Buzzer tones.
The oven does not heat up.	<p>Demo mode is activated. You can select menu options on the display and sensor buttons, but the oven heating does not work.</p> <ul style="list-style-type: none"> ■ Deactivate Demo mode with the Showroom program Demo Mode Off setting.
System lock  appears on the display when the oven is turned on.	<p>The  system lock is activated.</p> <ul style="list-style-type: none"> ■ Confirm with OK. <p>Press “OK” for 6 secs will appear.</p> <ul style="list-style-type: none"> ■ You can deactivate the system lock for a cooking program by touching the OK sensor button for at least 6 seconds. ■ If you want to permanently deactivate the system lock, select the Safety System lock  Off setting.

Frequently asked questions

Problem	Possible cause and solution
<p>You cannot start a cooking process.</p>	<p>If you are cooking with microwave power, the door may be open.</p> <ul style="list-style-type: none"> ■ Check whether the door is closed properly.
	<p>If you are cooking with microwave power, the power level or cooking duration is not selected.</p> <ul style="list-style-type: none"> ■ Check whether a microwave power level and a duration have been selected.
	<p>If you are cooking with an operating mode which uses microwave power, not all of the required settings have been entered.</p> <ul style="list-style-type: none"> ■ Check whether a microwave power level, a cooking duration, and a temperature have been selected.
<p>The sensor buttons do not respond.</p>	<p>You have selected the Display QuickTouch Off setting. When this is activated, the sensor buttons do not respond when the oven is turned off.</p> <ul style="list-style-type: none"> ■ As soon as the oven is turned on, the sensor buttons will respond. If you want the sensor buttons to respond even when the oven is turned off, select the Display QuickTouch On setting.
	<p>The oven is not connected to the domestic electrical supply.</p> <ul style="list-style-type: none"> ■ Make sure that the plug is correctly inserted in the socket and that the socket switch has been switched to on. ■ Check if the breaker has tripped. If it has, contact a qualified electrician or Miele Customer Service.
	<p>There is a fault with the controls.</p> <ul style="list-style-type: none"> ■ Touch and hold the  On/Off button until the display turns off and the oven restarts.
<p>Power failure appears on the display.</p>	<p>There has been a brief power failure. This has caused the current cooking process to stop.</p> <ul style="list-style-type: none"> ■ Turn the oven off and then back on again. ■ Restart the cooking process.
<p>12:00 appears on the display.</p>	<p>There was a power failure for more than 150 hours.</p> <ul style="list-style-type: none"> ■ Reset the date and time.

Frequently asked questions

Problem	Possible cause and solution
<p>Max. op. hours reached appears on the display.</p>	<p>The oven has been operating for an unusually long time. This has triggered the safety shut-off.</p> <ul style="list-style-type: none"> ■ Confirm with <i>OK</i>. <p>The oven is now ready to use again.</p>
<p>Fault and a fault code not listed here appear on the display.</p>	<p>A fault has occurred that you cannot resolve.</p> <ul style="list-style-type: none"> ■ Contact Miele Customer Service.
<p>If the door is opened during a cooking process using the Microwave  operating mode, the oven stops making noise.</p>	<p>This is not a fault. If the door is opened during a cooking process using the Microwave  operating mode, the door contact switch will switch off microwave power and switch the cooling fan to a lower speed.</p>
<p>You can hear a noise after a cooking program.</p>	<p>The cooling fan remains turned on after a cooking program (see “Settings – Cooling fan run-on”).</p>
<p>An abnormal sound can be heard when the oven is operating in microwave mode.</p>	<p>A metal dish has been used during a cooking process using microwave power.</p> <ul style="list-style-type: none"> ■ Check if there are sparks caused by using metal dishes (see “Microwave operation – Suitable dishware”).
	<p>The food was covered with aluminum foil during a cooking process using microwave power.</p> <ul style="list-style-type: none"> ■ If it is, remove the foil.
	<p>The wire rack was used during a cooking process using microwave power.</p> <ul style="list-style-type: none"> ■ Always use the glass tray when using the oven with microwave power.
<p>The oven has turned itself off.</p>	<p>To save power, the oven turns off automatically if a button is not pressed after a certain amount of time or after a cooking program has ended.</p> <ul style="list-style-type: none"> ■ Turn the oven back on.

Frequently asked questions

Problem	Possible cause and solution
<p>The cake/cookies are not baked properly.</p>	<p>A different temperature than that given in the recipe was used.</p> <ul style="list-style-type: none"> ■ Select the temperature required for the recipe.
	<p>The ingredient quantities are different from those given in the recipe.</p> <ul style="list-style-type: none"> ■ Check if you have amended the recipe. The addition of more liquid or more eggs will make a wetter mixture which will take longer to cook.
<p>The browning is uneven.</p>	<p>You selected the wrong temperature or shelf level.</p> <ul style="list-style-type: none"> ■ There will always be a slight unevenness. If browning is very uneven, check whether you selected the correct temperature and shelf level.
	<p>The material or color of the bakeware is not suitable for the operating mode selected. Light-colored, shiny, or thin-walled pans are less suitable. These reflect the oven's heat, which means that the heat does not penetrate to the food effectively, resulting in uneven or poor browning.</p> <ul style="list-style-type: none"> ■ Dark, matte baking pans are best for baking.
<p>The food is not sufficiently heated or is not cooked at the end of a set duration when using the Microwave  operating mode.</p>	<p>Check whether the cooking process using microwave power has been interrupted and has not been restarted.</p> <ul style="list-style-type: none"> ■ Restart the cooking process to ensure the food is heated or cooked properly.
	<p>When cooking or reheating with microwave power, the time set was too short.</p> <ul style="list-style-type: none"> ■ Check that the correct duration is selected for the microwave power level. The lower the microwave power level, the longer the duration required.

Frequently asked questions

Problem	Possible cause and solution
<p>Food has cooled down too quickly after being reheated or cooked using microwave power.</p>	<p>In the microwave, food begins to cook from the outside first, the inside of the food relying on the slower conduction of heat. If food is cooked at a high microwave power level, it is possible that the heat may not have reached the center of the food, so it is hot on the outside but cold in the centre. During the standing time, the heat is transferred to the center of the food.</p> <ul style="list-style-type: none"> ■ When reheating food with different densities, such as with menu cooking, it is sensible to start with a low microwave power level and select a longer reheating duration.
<p>The oven interior lighting turns off after a short time.</p>	<p>You have selected the Lighting “On” for 15 seconds setting.</p> <ul style="list-style-type: none"> ■ If you want the oven interior lighting to remain on during the entire cooking program, select the Lighting On setting.
<p>The oven interior lighting is off or does not turn on.</p>	<p>You have selected the Lighting Off setting.</p> <ul style="list-style-type: none"> ■ Press the  sensor button to turn the oven interior lighting on for 15 seconds. ■ If required, select the Lighting On or “On” for 15 seconds setting.
	<p>The oven interior lighting is faulty.</p> <ul style="list-style-type: none"> ■ Contact Miele Customer Service.

Information to help you rectify faults yourself and about Miele spare parts can be found at www.miele.com/service.

Contact in the event of a fault

In the event of a fault which you cannot remedy yourself, please contact your Miele dealer or Miele Customer Service.

You can book a Miele Service Call online at www.miele.com/service.

Contact information for Miele Customer Service can be found at the end of this document.

Please quote the model identifier and serial number of your appliance (SN) when contacting Miele Customer Service. Both pieces of information can be found on the data plate.

This information is given on the data plate, which is visible on the front frame of the oven when the door is fully open.

Appliance warranty and product registration

You can register your product and/or view the manufacturer's warranty terms and conditions for Miele appliances and vacuum cleaners at www.mieleusa.com.

Caring for the environment

Disposal of the packing material

The cardboard box and packing materials protect the appliance during shipping. They have been designed to be biodegradable and recyclable.

Ensure that any plastic wrappings, bags, etc. are disposed of safely and kept out of the reach of children.
Danger of suffocation!

Disposal of your old appliance

Electrical and electronic appliances contain valuable materials. They also contain certain substances, compounds and components which were essential for the proper functioning and safe use of the equipment. Handling these materials improperly by disposing of them in your household waste can be harmful to your health and the environment. Therefore, please do not dispose of your old appliance with regular household waste and follow local regulations on proper disposal.



Consult with local authorities, dealers or Miele in order to dispose of and recycle electrical and electronic appliances. Miele assumes no responsibility for deleting any personal data left on the appliance being disposed. Please ensure that your old appliance is kept away from children until removal. Observe safety requirements for appliances that may tip over or pose an entrapment hazard.

Installation dimensions H 7240 BM

The example shows installation in a 30" niche with trim kit EBA 7xxx.

Installation in a tall or base cabinet

Miele Ovens can be installed flush or proud. Discuss your requirements with your architect, kitchen designer, and installer.

More installation drawings are available on the Miele website.

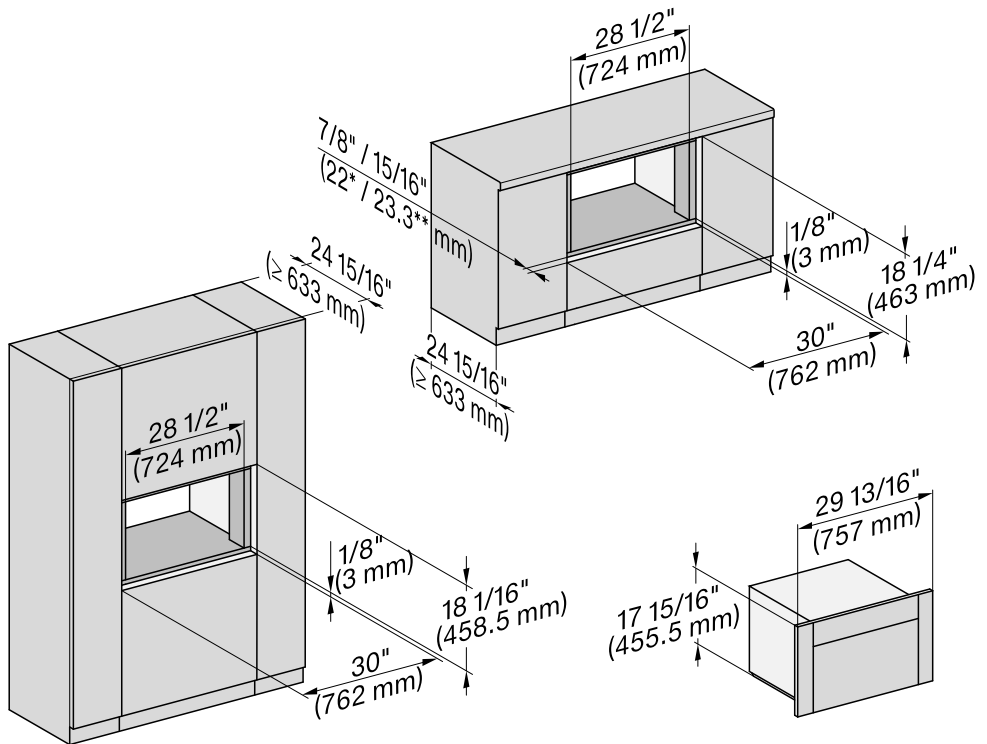

* Oven with glass front

** Oven with metal front

Installation

Side view

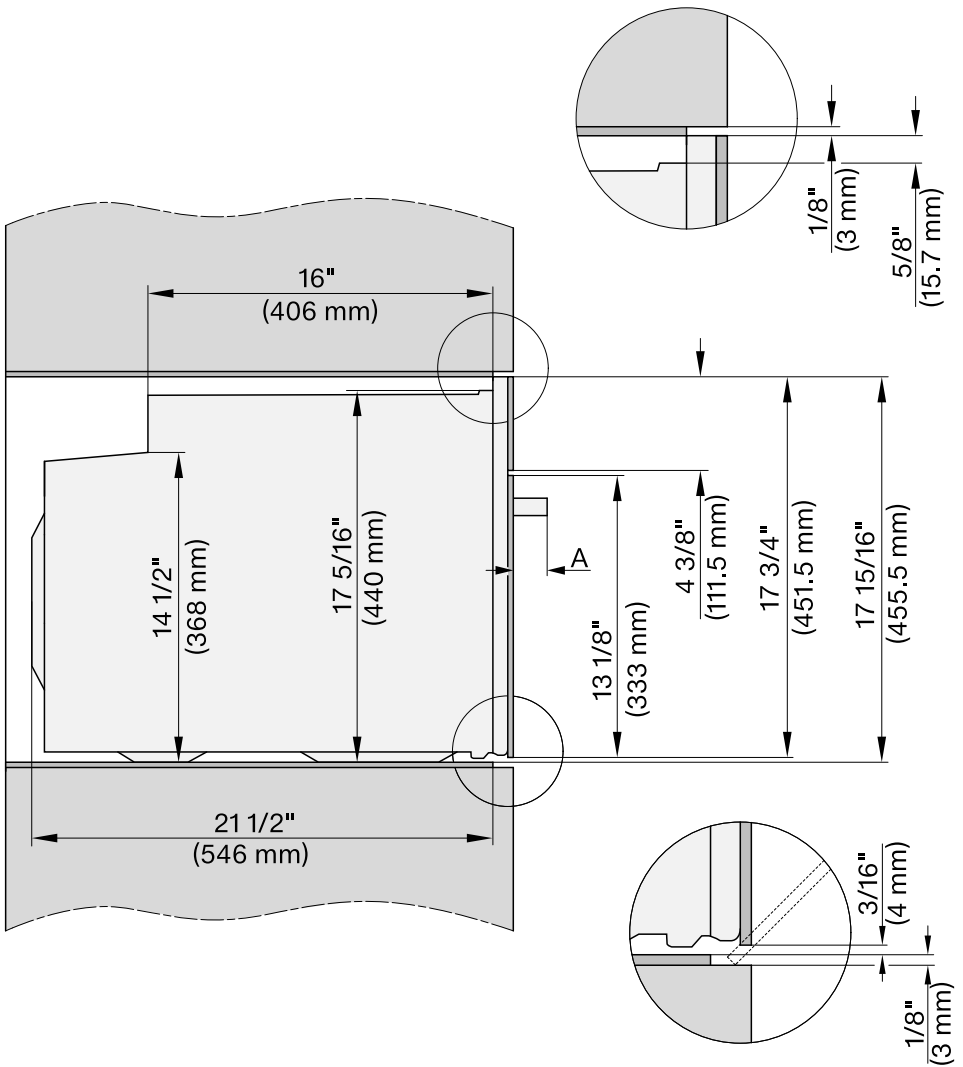

A H 72xx: 1 7/8" (47 mm)

Connections and ventilation

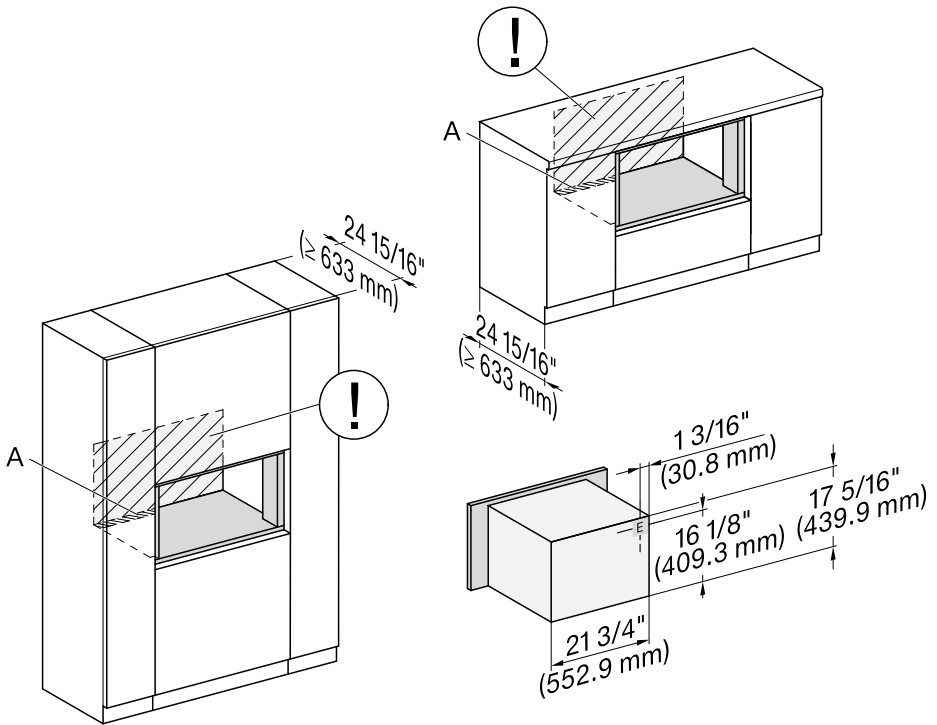

- A** Cutout $4'' \times 28 \frac{3}{8}''$ ($100 \text{ mm} \times 720 \text{ mm}$) in the base of the kitchen cabinet for power cord and ventilation
- ⓘ The outlet for the electrical connection should be accessible, e.g., in an adjacent kitchen cabinet. If the electrical connection is behind the oven, the kitchen cabinet needs to be deeper than specified.
- E** Electrical connection

Installation

Installation dimensions H 7170 BM, H 7270 BM

Installation in a tall or base cabinet

Miele Ovens can be installed flush or proud. Discuss your requirements with your architect, kitchen designer, and installer.

More installation drawings are available on the Miele website.

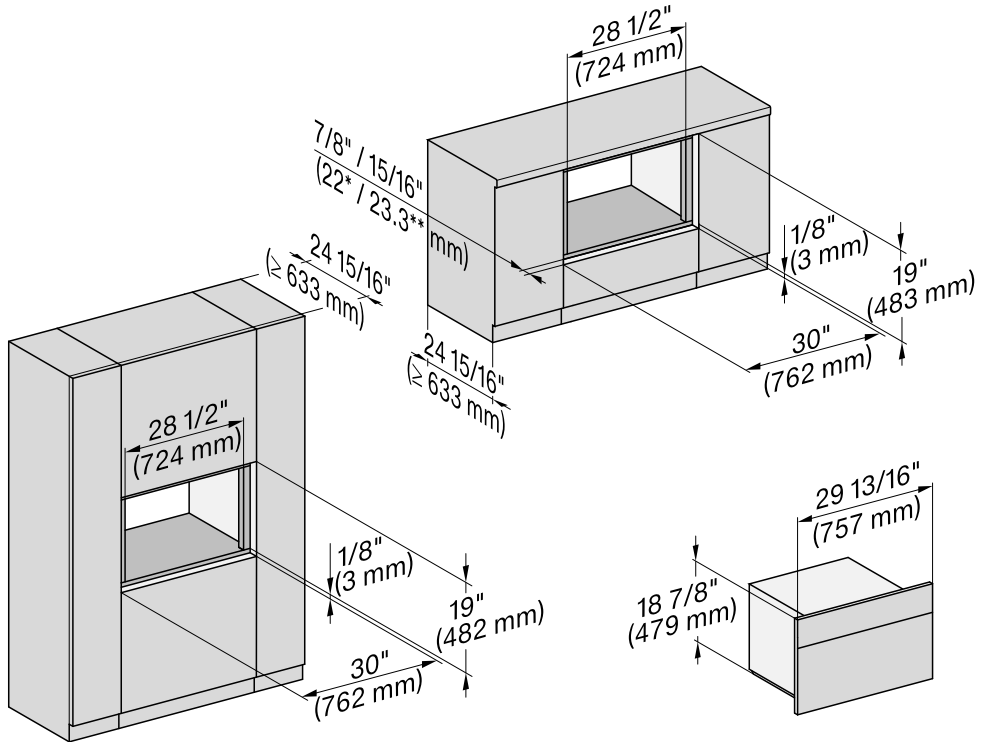

* Oven with glass front

** Oven with metal front

Side view

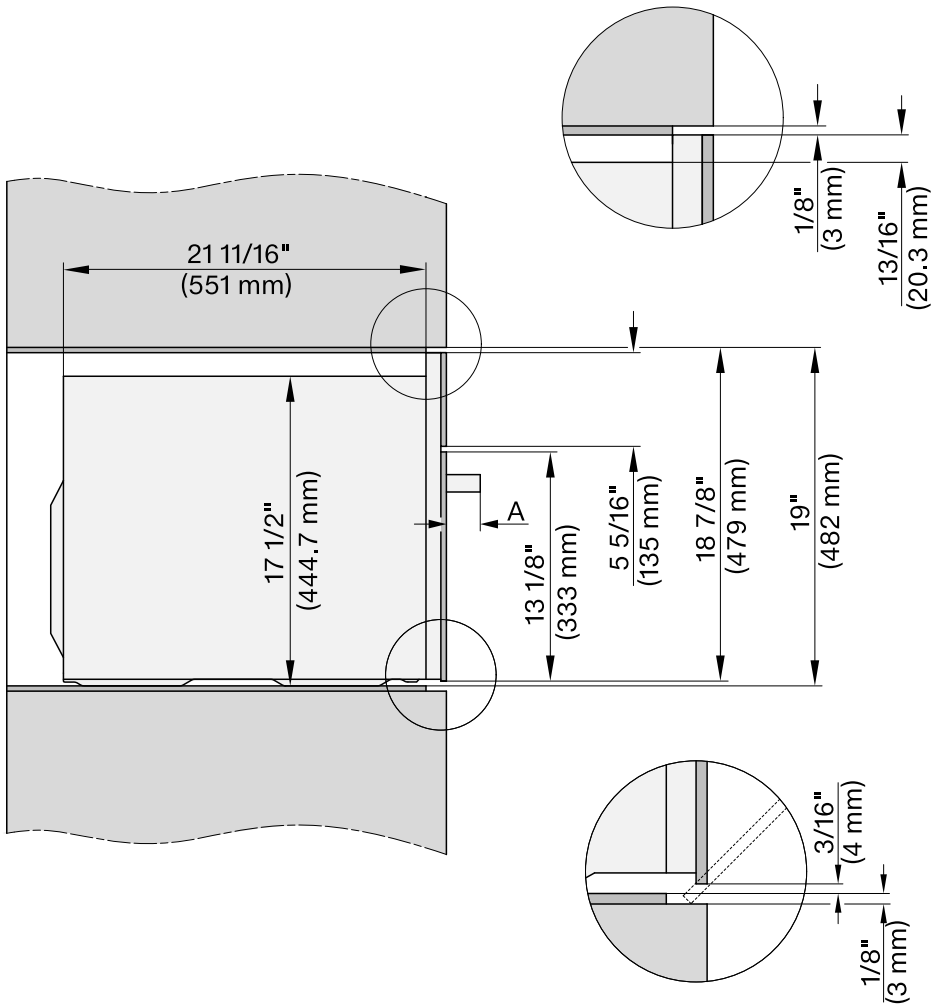

- A** H 71xx: $2 \frac{1}{2}''$ (64 mm)
 H 72xx: $1 \frac{7}{8}''$ (47 mm)

Installation

Connections and ventilation

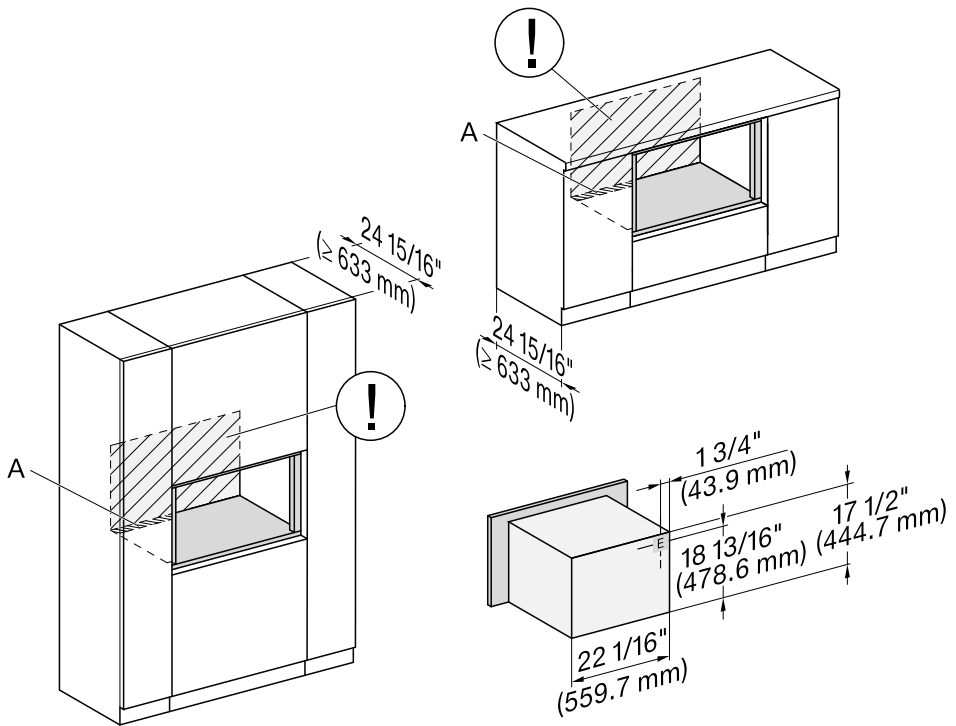

- A** Cutout $4'' \times 28 \frac{3}{8}''$ ($100 \text{ mm} \times 720 \text{ mm}$) in the base of the kitchen cabinet for power cord and ventilation
- ⓘ The outlet for the electrical connection should be accessible, e.g., in an adjacent kitchen cabinet. If the electrical connection is behind the oven, the kitchen cabinet needs to be deeper than specified.
- E** Electrical connection

Installing and removing the oven

For safety reasons, only use the oven when it has been fully installed.

Do not open the door when the oven is on the floor. This could damage the door.

Do not open the door until the oven has been installed inside the housing unit.

Securing the oven in the housing unit

- Connect the oven to the power supply.

Do not carry the oven by the door handle. This could damage the door. Use the carry handles on the side of the housing to lift the appliance.

- Push the oven into the housing unit far enough for you to be able to remove the carry handles.

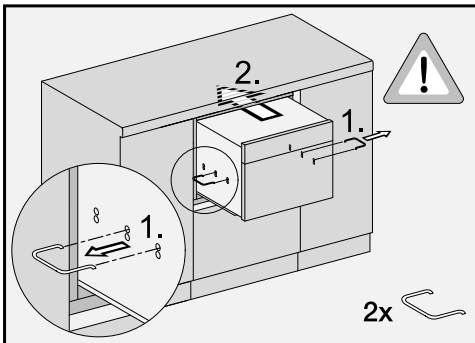

- Remove the carry handles (1.). Keep the carry handles in case the oven needs to be moved again in the future.
- Push the oven all the way into the housing unit and align it in the center of the unit (2.).

- Open the door.

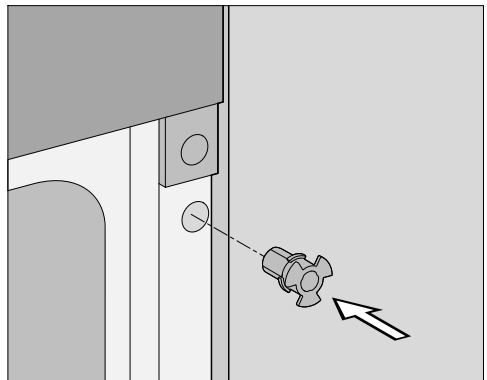
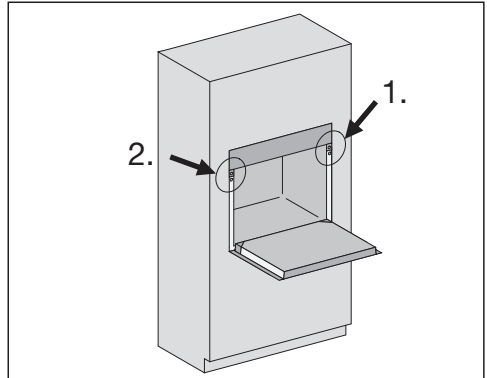

- Insert the mounting aid into the hole in the front frame.

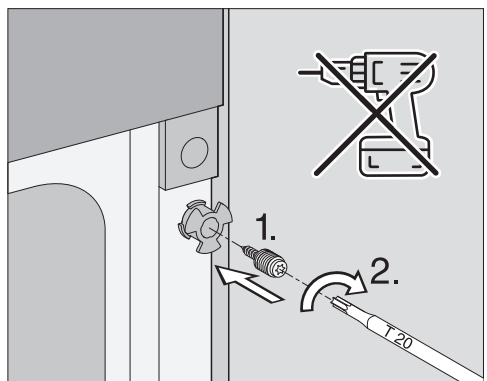

Installation

- Insert the bolt into the mounting aid and tighten it in the cabinet niche. **Do not** use a cordless screwdriver.

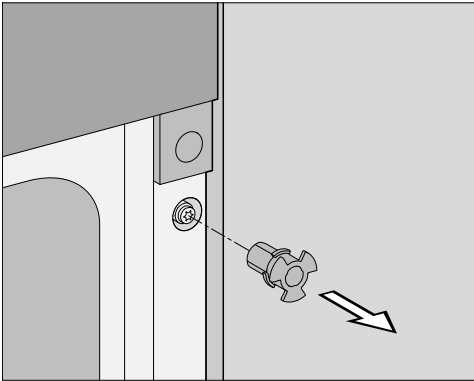

- Remove the mounting aid.

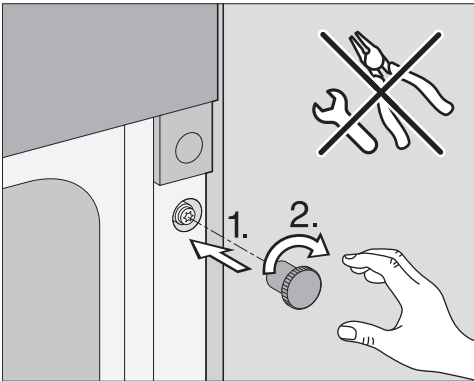

- Screw the knurled nut onto the bolt by hand to fix the oven in the cabinet niche.

The door may be damaged if the knurled nuts protrude from the front frame.

Make sure that the knurled nuts are flush with the front frame after installation.

- Repeat this process for the other side.

Taking the oven out of the housing unit

- Open the door.
- Unscrew the knurled nuts and bolts from the front frame (see “Securing the oven in the housing unit”). Keep these parts in case the oven needs to be installed again in the future.

 Risk of injury caused by dropping the appliance.

The oven can tip forward and cause serious injuries if the carry handles are inserted into the holes at the back.

Always insert the carry handles into the holes at the **front** of the side wall.

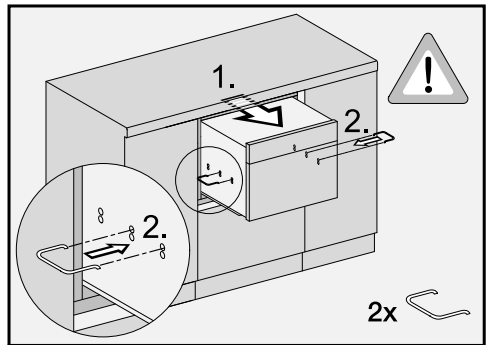

- Pull the oven out of the housing unit until the holes for the carry handles are visible (1.).
- Insert the carry handles into the holes at the **front** at the top of the side walls on each side of the oven (2.).

Do not carry the oven by the door handle. This could damage the door. Use the carry handles on the side of the housing to lift the appliance.

- Take the oven out of the housing unit.
- Disconnect the oven from the power supply.

Installation

Electrical connection



Risk of injury due to electric shock.

During installation, maintenance, and repair work, the oven must be completely disconnected from the power supply:

Disconnect the oven from the power supply by tripping the breakers, or unplugging the power cord from the outlet. To do this, pull the plug not the cord.



Risk of injury.

Installation, repairs, and other work by unqualified persons could be dangerous. Miele cannot be held liable for unauthorized work.

Installation, maintenance, and repairs must only be carried out by a Miele authorized technician.

The connection data (voltage and frequency) on the data plate of the oven must match the power supply in order to avoid the risk of damage to the oven.

Compare this before connecting the appliance to the power supply. If in any doubt, consult a qualified electrician.

For safety reasons, the oven may only be used when it has been fully installed.

The power cord plug must be inserted into a suitable outlet that has been installed and grounded in compliance with all applicable local codes.

WARNING: THIS APPLIANCE MUST BE GROUNDED

Installer: Please pass these instructions on to the customer.

Electrical connection

The oven is equipped with a power cord approx. 6 ft (1.8 m) long with a 4-pin NEMA 14-30P plug for connection to a power supply with:

- 2NAC 208 V, 30 A, 60 Hz
- or
- 2NAC 240 V, 30 A, 60 Hz

Temporary or permanent operation on an autonomous power supply system or a power supply system that is not synchronized with the grid power supply (e.g., island networks, back-up systems) is possible. A prerequisite for operation is that the power supply system complies with the specifications of EN 50160 or an equivalent standard. The function and operation of the protective measures provided in the domestic electrical installation and in this Miele product must also be maintained in isolated operation or in operation that is not synchronized with the grid power supply, or these measures must be replaced by equivalent measures in the installation. As described, for example, in the current version of VDE-AR-E 2510-2.

You can set the voltage variant (see “Settings – Electrical version”).

KEEP THE OPERATING AND INSTALLATION INSTRUCTIONS IN A SAFE PLACE.

Declaration of conformity

Supplier's Declaration of Conformity 47 CFR § 2.1077 Compliance Information

Microwave Function

Unique Identifier: Miele Model:
H 7240 BM, H 7170 BM or H 7270 BM

Responsible Party

Miele, Inc.
National Headquarters
9 Independence Way
Princeton, NJ 08540
Phone: 800-843-7232
Fax: 609-419-4298
www.mieleusa.com

FCC Compliance Statement: This device complies with Part 18 of the FCC Rules.

Regarding radiological health this product complies with DHHS rules 21 CFR Subchapter J.

IC Compliance Statement:

This device complies with
CAN ICES-001 (B) / NMB-001 (B)

Radio Module

This device contains the following WiFi module:

FCC ID	2AC7Z-EK057
IC ID	21098-EK057
Frequency band	2.412 GHz – 2.462 GHz
Maximum transmitting power	< 0.2 W

Compliance Statement

This device complies with Part 15 of the FCC Rules and contains licence-exempt transmitter(s)/receiver(s) that comply with Innovation, Science and Economic Development Canada's licence-exempt RSS Standard(s). Operation is subject to the following two conditions:

- (1) this device may not cause harmful interference, and
- (2) this device must accept any interference received, including interference that may cause undesired operation.

The construction of the device assures that the FCC/IC exposure limits are verifiably met using the integrated radio module.

Warning!

Any changes or modifications to this unit not expressly approved by the party responsible for compliance could void the user's authority to operate the equipment.

Copyrights and licenses for the communication module

For the purpose of operating and controlling the communication module, Miele uses proprietary or third-party software that is not covered by open source licensing terms. This software/ these software components are protected by copyright. The copyrights held by Miele and third parties must be respected.

This communication module contains software components which are distributed under open source license conditions. The open source components contained in the appliance along with the corresponding copyright notices, copies of the licensing terms valid at the time, and any additional information can be accessed locally via *http://<IP address>/Licenses*. The liability and warranty arrangements for the open source licenses displayed in this location only apply in relation to the respective rights holders.

**Please have the model and serial number
of your appliance available when
contacting Customer Service.**

U.S.A.

Miele, Inc.

National Headquarters

9 Independence Way
Princeton, NJ 08540
www.mieleusa.com

Customer Support

Phone: 888-99-MIELE (64353)
info@mieleusa.com

International Headquarters

Miele & Cie. KG
Carl-Miele-Straße 29
33332 Gütersloh
Germany

Canada

**Importer
Miele Limited**

Headquarters and Miele Centre

161 Four Valley Drive
Vaughan, ON L4K 4V8
www.miele.ca

Customer Care Centre

Phone: 1-800-565-6435
905-532-2272
customercare@miele.ca

H 7240 BM, H 7170 BM, H 7270 BM

en-US, CA

M.-Nr. 11 900 040 / 03