



Operating and Installation Instructions Washer



To prevent accidents and appliance damage, read these instructions **before** installation or use.





Contents

Caring for the environment	6
IMPORTANT SAFETY INSTRUCTIONS	7
Guide to the washer	12
Control panel	12
Examples on how to operate the appliance	14
Before using for the first time	15
Miele@home	16
1. Setting the display text	17
2. Setting up Miele@home	17
3. Removing the shipping struts	18
4. Commissioning TwinDos	18
Determining the water hardness	18
5. Starting the calibration program	21
Environmentally friendly washing	22
Energy and water consumption	22
Detergent consumption	22
 Feedback	23
1. Prepare the laundry	24
2. Selecting a program	25
3. Loading the washing machine	27
4. Selecting program settings	28
Selecting a temperature/spin speed	28
Selecting an extra option	28
 Degree of soiling	28
 Delay start/SmartStart	29
5. Adding detergent	31
Detergent dispenser drawer	33
Using chlorine bleach	33
Adding powder detergent	34
Adding fabric softener	35
CapDosing	36
6. Starting a program	38
Adding laundry during a program sequence (AddLoad)	38
7. Program end	39

Spin cycle	40
Program guide	42
Extra options	49
SoftSteam	49
Pre-wash	49
Buzzer	49
Extra options can be selected using the Options sensor button	50
Extra Gentle	50
ExtraRinse	50
Soak	50
AllergyWash	50
Wash program overview – extra options	51
Program sequence	52
Changing the program sequence	54
Changing a program (safety lock)	54
Interrupting a program	54
Canceling a program	54
Detergent	55
Detergents recommended by Miele	55
General detergent recommendations	56
Replacing the TwinDos cartridge	57
Cleaning and care	58
Cleaning the housing and control panel	58
Cleaning the detergent dispensing drawer	58
TwinDos maintenance	61
Sanitize info(Cleaning the drum)	62
Cleaning the water-inlet filter	62

Contents

Frequently Asked Questions	63
A wash program cannot be started	63
Fault message after a program has been interrupted	64
Fault message after the end of the program	65
Messages or faults affecting the TwinDos system	66
General problems with the washer	68
Poor wash results	70
The drum door cannot be opened	71
Opening the door in the event of a blocked drain outlet and/or power outage ..	72
Customer Service	74
Contact in the event of a fault	74
Optional accessories.....	74
Appliance warranty and product registration	74
Installation	75
Front view	75
Rear view.....	76
Installation surface	77
Transporting the washing machine to its installation site.....	77
Removing the shipping struts	78
Installing the shipping struts	80
Leveling the machine.....	81
Unscrewing and adjusting the feet.....	81
Installing under a countertop.....	82
Washer-dryer stack	82
Additional installation requirements	83
Installing under a countertop.....	83
Setting up the cabinet	83
For closets at room height.....	84
Product Dimensions	84
Dimensions.....	84
Installation on a plinth	85
Washer-dryer stack	85
The water protection system.....	86
Water intake	87
Water drainage	88
Installing the elbow.....	88
Electrical connection.....	89
Technical data	90

Settings	91
Calling up settings.....	91
Selecting settings.....	91
Changing a setting	91
Closing the Settings menu	91
Language 	92
TwinDos.....	92
Select detergent	92
Degree of soiling.....	92
Buzzer volume.....	92
Keypad tone	93
Welcome tone	93
Code.....	93
Unit.....	94
Brightness	94
Display switch-off.....	95
Program info.....	95
Memory	95
Water intake	95
Soak duration	96
Gentle action	96
Temp. reduction.....	96
Maximum rinse level.....	96
Suds cooling.....	96
Low water pressure	97
Anti-Crease.....	97
Miele@home	97
Remote control.....	98
SmartGrid	98
RemoteUpdate	99
Bleach	100
Copyrights and licenses for the communication module.....	100
Detergents and care products	101
Detergent.....	101
Special-purpose detergents 	102
Fabric care 	103
Additives 	103
Machine care	103

Caring for the environment

Disposal of the packing material

The cardboard box and packing materials protect the appliance during shipping. They have been designed to be biodegradable and recyclable.

Ensure that any plastic wrappings, bags, etc. are disposed of safely and kept out of the reach of children.
Danger of suffocation!

Disposal of your old appliance

Electrical and electronic appliances contain valuable materials. They also contain certain substances, compounds and components which were essential for the proper functioning and safe use of the equipment. Handling these materials improperly by disposing of them in your household waste can be harmful to your health and the environment. Therefore, please do not dispose of your old appliance with regular household waste and follow local regulations on proper disposal.



Consult with local authorities, dealers or Miele in order to dispose of and recycle electrical and electronic appliances. Miele assumes no responsibility for deleting any personal data left on the appliance being disposed. Please ensure that your old appliance is kept away from children until removal. Observe safety requirements for appliances that may tip over or pose an entrapment hazard.

IMPORTANT SAFETY INSTRUCTIONS

WARNING

To reduce the risk of fire, electric shock or injury to persons while using your appliance follow basic safety precautions, including the following:

▶ Read all instructions before using the appliance.

▶ GROUNDING INSTRUCTIONS

This appliance must be grounded. In the event of a malfunction or breakdown, grounding will reduce the risk of electric shock by providing a path of least resistance for electric current. This appliance is equipped with a cord having an equipment-grounding conductor and a grounding plug. The plug must be plugged into an appropriate outlet that is properly installed and grounded in accordance with all local codes and ordinances.

▶ **WARNING** - Improper connection of the equipment-grounding conductor may result in a risk of electric shock. Check with a qualified electrician if you are in doubt as to whether the appliance is properly grounded.

▶ Do not modify the plug provided with the appliance - if it will not fit the outlet, have a proper outlet installed by a qualified electrician.

▶ Do not install or use a washer with visible damage.

▶ Do not install or store this appliance where it will be exposed to the weather.

▶ Do not install your washing machine where temperatures below freezing may occur. Frozen hoses may burst under pressure. The reliability of the electronic control unit may be impaired at temperatures below freezing.

IMPORTANT SAFETY INSTRUCTIONS

- ▶ Before connecting the machine, ensure that the connection data on the data plate (fusing, voltage and frequency) match the mains electrical supply. If in doubt contact an electrician.
- ▶ Do not use an extension cord to connect this appliance to the power supply. Extension cords do not guarantee the required safety of the appliance (e.g. danger of overheating).
- ▶ This appliance is not designed for maritime use or for use in mobile installations such as recreational vehicles or aircraft. However, under certain conditions it may be possible for an installation in these applications. Please contact the Miele Service Dept. with specific requirements.
- ▶ Do not repair or replace any part of the appliance or attempt any servicing unless specifically recommended in these operating instructions.
- ▶ If the power cord is damaged it must only be replaced by a Miele Service technician with a genuine Miele power cord.
- ▶ Under certain conditions, hydrogen gas may be produced in a hot water system that has not been used for 2 weeks or more. **HYDROGEN GAS IS EXPLOSIVE.** If the hot water system has not been used for such a period, turn on all hot water faucets and let the water flow from each for several minutes before using the washing machine. This will release any built-up hydrogen gas. Do not smoke or use an open flame during this time, the gas is flammable.
- ▶ Before the appliance is removed for service or discarded, remove the door.

IMPORTANT SAFETY INSTRUCTIONS

Use

- ▶ Do not allow children to play on or in the appliance. Close supervision is necessary when the appliance is used near children.
- ▶ The drum door glass will be hot when washing at very high temperatures. Do not touch the glass. Danger of burns! Keep children away from the washer when in use.
- ▶ Only use the washing machine to wash items which are specified by the manufacturer to be machine washable on the fabric care label. Any other applications may be dangerous.
- ▶ Do not wash articles that have been previously cleaned, washed, soaked or spotted with gasoline, dry-cleaning solvents or other flammable substances. These articles give off vapors that could ignite or explode. Do not add these items to the wash load.
- ▶ Do not add gasoline, dry-cleaning solvents, or other flammable or explosive substances to the wash water. These substances give off vapors which could ignite or explode.
- ▶ Do not use cleaning solvents on or near the machine or the controls. Contact with cleaning solvents will damage the surface..
- ▶ Do not reach into the appliance if the drum is moving.
- ▶ Do not tamper with the controls.

SAVE THESE INSTRUCTIONS

IMPORTANT SAFETY INSTRUCTIONS

- ▶ Miele tumble dryers and Miele washing machines can be installed as a washer-dryer stack. A Miele washer-dryer stacking kit is required as an optional accessory for this. Please ensure that the washer-dryer stacking kit is suitable for the Miele tumble dryer and the Miele washing machine.
- ▶ If installing the machine on a Miele plinth (available as an optional accessory), please make sure you order the correct one for this washing machine.
- ▶ Should detergent enter the eyes, rinse out immediately with plenty of lukewarm water. If accidentally ingested, seek medical advice immediately. People who have sustained damage to the skin or who have sensitive skin should avoid contact with the detergent.
- ▶ Be careful when opening the door following use of the steam function. There is a danger of burning due to escaping steam and the high temperature of the surface of the drum as well as the porthole glass. Step back and wait until the steam has dissipated.
- ▶ The maximum dry laundry weight is 17.6 lb (8 kg). See the “Program guide” for the maximum recommended loads for individual programs.
- ▶ Temporary or permanent operation on an autonomous power supply system or a power supply system that is not synchronized with the grid power supply (e.g., island networks, back-up systems) is possible. A prerequisite for operation is that the power supply system complies with national and local codes.
The function and operation of the protective measures provided in the domestic electrical installation and in this Miele product must also be maintained in isolated operation or in operation that is not synchronized with the grid power supply, or these measures must be replaced by equivalent measures in the installation.

IMPORTANT SAFETY INSTRUCTIONS

FCC Declaration of Conformity

▶ These devices comply with FCC Rules Part 15. This equipment has been tested and found to be in compliance with the limits for a Class B digital device, pursuant to Part 15 of the FCC Rules of Operation and is subject to the following conditions:
These devices may not cause harmful interference.
These devices must accept any interference received, including interference that may cause undesired operation.

FCC Radiation Exposure Statement

▶ This equipment complies with FCC radiation exposure limits set forth for an uncontrolled environment. This equipment should be installed and operated with minimum distance 8" (20 cm) between the radiator and your body.

Industry Canada Statement

▶ This digital apparatus does not exceed the Class B limits for Radio Noise Emissions from digital apparatus set out in the Radio Interference Regulations of the Canadian Department of Communications.

Complies with Canadian ICES-003 Class B specifications.

Guide to the washer

Control panel

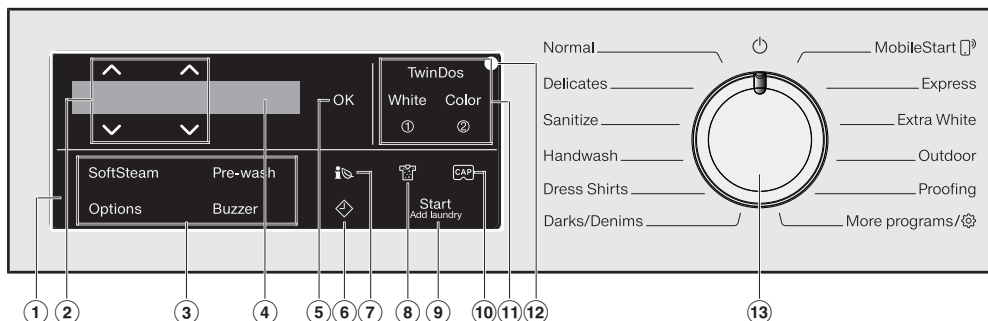

① Control field

The control field consists of a display and various sensor buttons. The individual sensor buttons are explained in the following sections.

② Sensor buttons \wedge \vee

The values in the display can be changed with the \wedge \vee sensor buttons. The \wedge sensor button increases the value or moves the selection list up; the \vee sensor button decreases the value or moves the selection list down.

③ Sensor buttons for extra options

You can supplement the wash programs with extra options. If a wash program has been selected, the sensor buttons for the possible extras light up dimly.

④ Display

The following values are displayed and/or selected on the display:

1. The temperature, spin speed, and time left for the selected wash program.
2. The individual values of the selection lists for extras and settings.

⑤ OK sensor button

The OK sensor button is used for confirming selected values.

⑥ Sensor button \diamond

The sensor button \diamond starts the delay start function. With the delay start function, you can delay the start of the program. The start of the program can be delayed from 15 minutes up to a maximum of 24 hours.

Please see “Delay start” for more information.

⑦ **sensor button**

You can view information about the energy and water consumption of your washing machine with the  sensor button.

See “Washing environmentally and economically” under the “Feedback” section for additional information.

The following information will appear in the display:

- An estimate of the energy and water consumption before the program begins.
- The actual energy and water consumption during the program or at the end of the program.

⑧ **sensor button**

You can specify the degree of soiling of the load in three settings. This sensor button is only active with the *TwinDos* option activated.

⑨ **Start/Add laundry sensor button**

- Ⓐ The program can be started as soon as the sensor button is flashing on and off. Touching the *Start/Add laundry* sensor button starts the selected program. The sensor button lights up constantly.
- Ⓑ Once the program has been started, the *Start/Add laundry* sensor button allows you to add laundry.

⑩ **Sensor button**

Activate detergent dispensing with a capsule by using the sensor buttons.

⑪ **TwinDos sensor button with the additional Whites and Colors sensor buttons**

The *TwinDos* sensor button is used for deactivating and activating automatic detergent dispensing. Depending on the color composition of your load, you can control the detergent combination by selecting the *Whites* or *Colors* sensor button. Please see “*TwinDos*” for additional information.

⑫ **Optical interface**

This is used by the Service department as a transmission point.

⑬ **Program selector**

for selecting programs and for switching the machine off. The washing machine is switched on when you select a program, and switched off by turning the program selector to the  position.



Guide to the washer

Examples on how to operate the appliance

Scrolling through a list

The  scroll bar in the display indicates that a selection is available.



The list scrolls down when the  sensor button is touched. The list scrolls up when the  sensor button is touched. The *OK* sensor button is used to activate the option in the display.



Identifying the selected option



An activated option in a list will have a check mark  next to it.

Setting numerical values



The numerical value is highlighted in white. Touching the  sensor button decreases the value. Touching the  sensor button increases the value. The *OK* sensor button is used to activate the value in the display.

Leaving a submenu

Select *Back*  to exit a submenu.

Before using for the first time

 Damage from incorrect installation and connection. Installing and connecting the washing machine incorrectly will cause serious damage to property. See “Installation”.

Removing the protective film and stickers

■ Remove:

- any protective film from the door
- any stickers from the front and from the lid

Please do not remove any labels (e.g., the data plate) which are visible when you open the door.

This washing machine has undergone a complete functional test at the factory and some residual water will therefore remain in the drum from this process.

Remove the detergent cartridges and the drain hose elbow from the drum

Two detergent cartridges for automatic detergent dispensing and an elbow piece for the drain hose are stored in the drum.



- Pull open the door.
- Take the two cartridges and the elbow piece out of the drum.

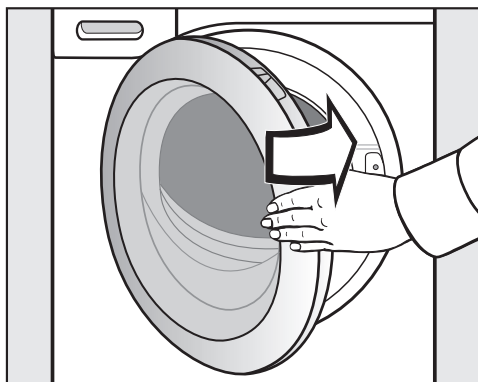

- Shut the door.

Before using for the first time

Miele@home

Your washing machine is equipped with an integrated WiFi module.

To use this feature, you will need:

- A WiFi network
- The Miele@mobile app
- A Miele user account. The user account can be created via the Miele@mobile app.

The Miele@mobile app will guide you as you connect your washing machine to your home WiFi network.

Once your washing machine is connected to your WiFi network, you can use the app, for example, to carry out the following activities:

- Operate your washing machine remotely
- Access information about the operating status of your washing machine
- Access information about a program sequence on your washing machine

Connecting your washing machine to your WiFi network will increase energy consumption, even when the washing machine is switched off.

Before installing the washing machine in its final location, ensure the signal strength is sufficient for your WiFi network.

Availability of the WiFi connection

The WiFi connection shares a frequency range with other appliances (including microwave ovens and remote control toys). This can cause sporadic or even complete connection failures. Therefore, the availability of featured functions cannot be guaranteed.

Miele@home availability

The ability to use the Miele app depends on the availability of the Miele@home service in your country.

The Miele@home service is not available in every country.

For information about availability, please visit www.miele.com.

Miele App

The Miele App is available to download free of charge from the Apple App Store® or from the Google Play Store™.



Switching on the washing machine

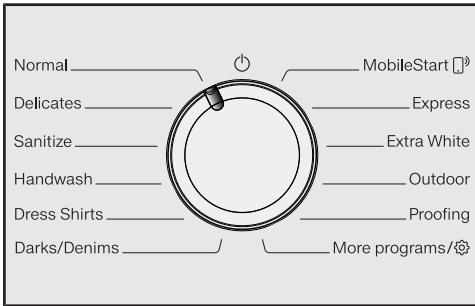

- Turn the program selector to the *Normal* program.

The welcome tone will sound and the welcome screen will light up.

The display will guide you through the **5 steps** of the initial commissioning.

1. Setting the display text

You will be asked to set the display language. It is possible to change the language at any time by setting the program selector to *Additional programs* in the *Settings* submenu.



- Touch the ∇/\wedge sensor buttons until the language you want appears in the display.
- Confirm your choice of language by touching the *OK* sensor button.

2. Setting up Miele@home

The following message appears in the display:

i Miele@home

- Confirm with *OK*.

The following message appears in the display:

Set up now

- To set up Miele@home now: touch the *OK* sensor button.
- To postpone setup: touch the ∇ sensor button until the following appears in the display: Set up later and press the *OK* button to confirm.

The following selection options appear in the display:

1. Connect via WPS
2. Connect via App

- Select the required connection type.

You will then be guided by the display and the Miele app.

Before using for the first time

3. Removing the shipping struts

 Damage resulting from failure to remove the shipping struts. Failure to remove the shipping struts can result in damage to the washing machine and to adjacent cabinetry or appliances. Remove the shipping struts as described in “Installation and connection”.

The following message appears in the display:

-  Remove shipping struts
- Confirm with the *OK* sensor button.

4. Commissioning TwinDos

The UltraPhase 1 and UltraPhase 2 values are pre-set in the standard settings and only need to be confirmed.

The following message appears in the display:

-  TwinDos
- Confirm with the *OK* sensor button.

The following message appears in the display:

- Set now
- To set up TwinDos now, touch the *OK* sensor button.
- To postpone setup: touch the  sensor button until the following appears in the display: *Set up later* and press the *OK* button to confirm.

Determining the water hardness

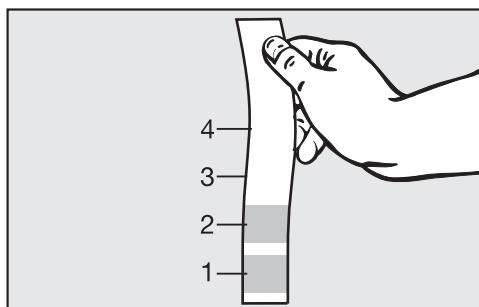

Water hardness is an indication of the amount of minerals dissolved in water. The more minerals in the water, the higher the water hardness and more detergent must be dispensed.

Tip: You can measure the water hardness yourself using the enclosed test strip. Alternatively, your local water authority will be able to tell you the hardness of water in your area.



- Dip the test strip in the water for approx. 1 second. Shake excess water off the test strip.

After approx. 1 minute, and based on the coloration, you will be able to read the water hardness from the table below.

Test strip	Hardness range
4 green areas	 Hardness level I
1 red area	
2 red areas	 Hardness level II
3 red areas	 Hardness level III
4 red areas	

Before using for the first time

Settings for compartment ①

The UltraPhase 1 values are pre-set in the standard default settings.



- Confirm with the OK sensor button.



- Confirm with the OK sensor button.

The following will appear in the display:



i Set the dosage. Observe water hardness levels

- Confirm with the OK sensor button.

The dispensing quantity for UltraPhase 1 for  (**hardness level I**) is pre-set.



- Confirm the pre-set value with the OK sensor button. If you want to change this value, use the ∇/Δ sensor buttons and confirm with the OK sensor button.

UltraPhase 1		
	Hardness level I	46 ml
	Hardness level II	58 ml
	Hardness level III	70 ml

The following will appear in the display:

i Insert ①

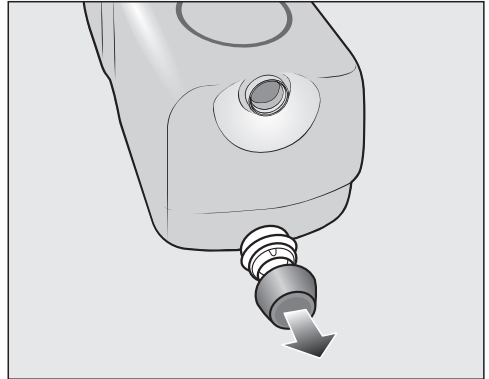

- Remove the cover cap from the **UltraPhase 1** detergent cartridge included with the delivery.

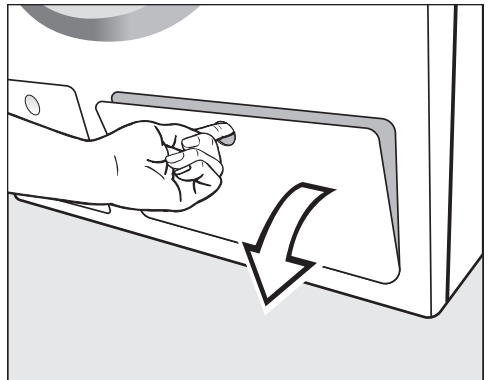

- Open the TwinDos flap.

Before using for the first time

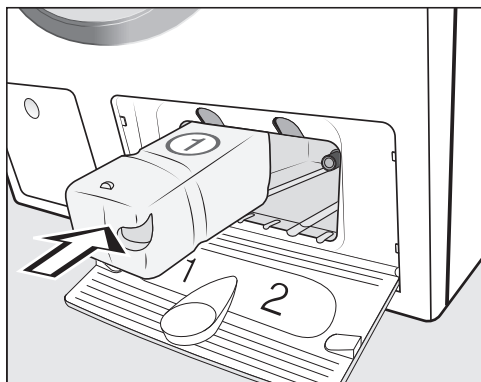

- Push the **UltraPhase 1** detergent cartridge into **compartment 1** until it locks into position.

Settings for compartment ②

The UltraPhase 2 values are pre-set in the standard default settings.

After the cartridge has been pushed in, the display message switches to:



- Confirm with the *OK* sensor button.





- Confirm with the *OK* sensor button.

The dispensing quantity for UltraPhase 2 for  (**hardness level I**) is pre-set.



- Confirm the pre-set value with the *OK* sensor button. If you want to change this value, use the ∇/\blacktriangle sensor buttons and confirm with the *OK* sensor button.

UltraPhase 2		
	Hardness level I	36 ml
	Hardness level II	45 ml
	Hardness level III	54 ml

The following will appear in the display:

- i** Insert ②

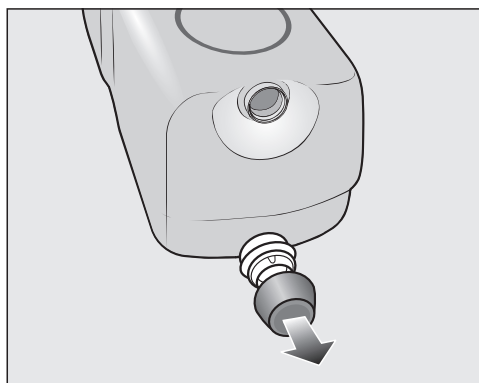

- Remove the cover cap from the **UltraPhase 2** detergent cartridge included with the delivery.

Before using for the first time

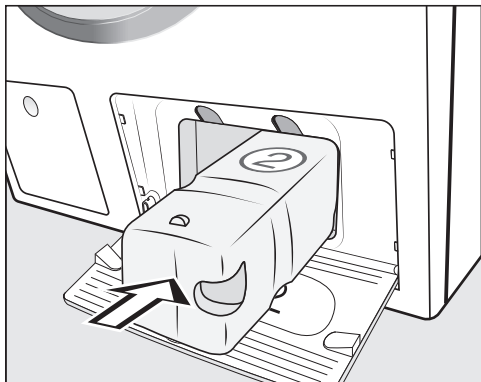

- Push the **UltraPhase 2** detergent cartridge into **compartment 2** until it locks into position.

When the cartridge is pushed in, the message in the display changes to:

i "TwinDos" set. Can be changed in "Settings".

- Confirm with the *OK* sensor control.
- Close the TwinDos flap.

5. Starting the calibration program

For optimum water and energy consumption and excellent wash results, it is important to calibrate the washing machine.

To do this, the *Normal* program **must** be run without laundry and without detergent.

No other programs can be started until calibration has been carried out.

The following message appears in the display:

Open  and run "Normal" with "Hot Plus" without laundry.

- Touch the ∇ sensor button until the *OK* sensor button lights up and confirm with *OK*.
- Turn on the faucet.
- Touch the *Start/Add laundry* sensor button.

The washing machine calibration program has started. It will take approximately 2 hours.

At the end of the program, the following message will appear in the display:

- i** Set up complete



- Take hold of the door and pull it open.

Tip: Leave the door slightly open to allow the drum to dry.

- Turn the program selector to the  position.

Environmentally friendly washing

Energy and water consumption

- Make use of the maximum load of the respective wash program. The energy and water consumption will then be the lowest in relation to the size of the load.
- When smaller amounts of laundry are washed, the washing machine's automatic load control system will reduce the amount of water and energy used.
- Use the *Express* program for small, lightly soiled loads.
- Modern detergents make it possible to wash at lower temperatures. Using the corresponding temperature settings will save energy.
- Washing at low temperatures and/or using liquid detergents can cause bacteria and odors to build up in the washing machine. Miele therefore recommends cleaning the washing machine once every month.

The washing machine provides you with a reminder with the message Sanitize info: Run the "Sanitize" or "Clean Machine" program in the display.

Detergent consumption

- Use the TwinDos system for exact dispensing.
- Adjust the dosage to the level of soiling of the laundry.
- Do not exceed the amounts of detergent recommended on the packaging.
- Only use high efficiency detergent with the following label:



When drying with a tumble dryer

Select the highest possible spin speed for the wash program to save energy in the subsequent tumble dryer cycle.

Environmentally friendly washing

Feedback

You can view information about the energy and water consumption of your washing machine with the  sensor button.

The following information will appear in the display:

- An estimate of the energy and water consumption before the program begins.
- The actual energy and water consumption during the program or at the end of the program.

1. Estimate

- After selecting a wash program, touch the  sensor button.

The estimated energy and water consumption levels will be displayed as a bar chart.



The more bars visible (|), the higher the energy or water consumption.

The estimate will vary depending on the wash program, temperature, and any extra options selected.

- Touch the **OK** sensor button or wait until the display automatically returns to the standard display.

2. Actual consumption

You can view the actual amount of energy and water used by a program both during and at the end of the program.

- Touch the  sensor button.



- Use the ∇/Δ sensor buttons to change to the estimated water-consumption levels.

The consumption will alter as the program progresses.

If the door is opened or the machine has switched off automatically at the end of the program, the data will revert to the estimated consumption.

Tip: You can view the consumption data for the last wash program in **Settings**  under **Consumption**.

1. Prepare the laundry

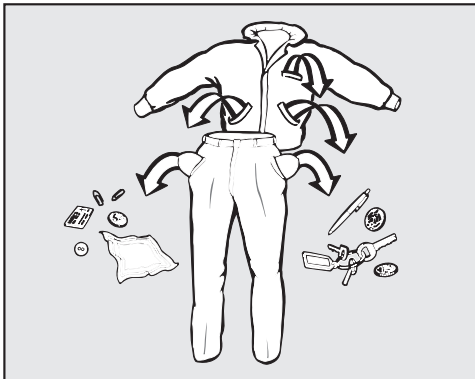

- Empty all pockets.

⚠ Damage due to foreign objects. Nails, coins, paper clips, and so on can cause damage to garments and components in the machine. Check the laundry before washing and remove any such foreign objects.

Sort the laundry

Only wash items that are labeled machine washable by the manufacturer. Most garments have a fabric care label in the collar or side seam.

- Sort the laundry by care label and color.

Tip: Dark fabrics often bleed the first few times they are washed. They should be washed separately several times before being included in a mixed load.

Pre-treating stains

- Badly soiled areas and stains should be cleaned as soon as possible, preferably while still fresh. Stains should be carefully dabbed off using a soft cloth. Do not rub!

Tip: Stains (such as blood, egg, coffee, and tea) can be pre-treated using some handy tricks which can be found in the Miele guide to laundry care. Please contact Miele directly or submit a request via Internet page to obtain or view a copy of this manual.

⚠ Damage due to solvent-based cleaning agents
Cleaning agents containing benzene, stain remover, etc., can damage plastic parts.
When pre-treating a stain, make sure that plastic parts do not come into contact with cleaning agents.

⚠ Risk of explosion due to solvent-based cleaning agents.
When using solvent-based cleaning agents, an explosive mixture may develop.
Never use solvent-based cleaning agents in the washing machine.

General tips

- Curtains: Remove any lead weights or strips before washing.
- Loose bra underwires should be removed or sewn in place before washing.
- Close zippers, hooks and eyelets before washing.
- Comforter covers and pillowcases should be fastened to prevent small items from rolling inside of them.

Do not wash items with the  symbol on the fabric care label.

2. Selecting a program

Switching on the washing machine

- Turn the program selector to a program.

Program selection

There are three possible ways to select a program:

1. Selecting the standard programs with the program selector dial

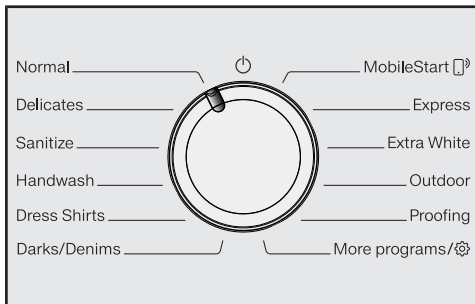

- Turn the program selector to the required program.

The selected program will be shown in the display. This will then be replaced by the standard display.

2. Selecting additional programs by setting the program selector to “Additional programs/” and using the display:

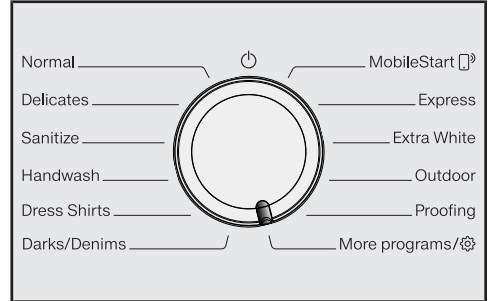

- Turn the program selector to the *Additional programs/* position.

The following appears in the display:



- Touch the ∇/\blacktriangle sensor buttons until the program you want appears in the display.
- Confirm the program with the *OK* sensor button.

Pre-set program parameters will be displayed, depending on the program selected.

2. Selecting a program

3. Selecting programs via the MobileStart program selector position and the Miele@mobile app

Tip: In order to use *MobileStart* , the washing machine must be logged on to the WiFi network and Remote control must be switched on.

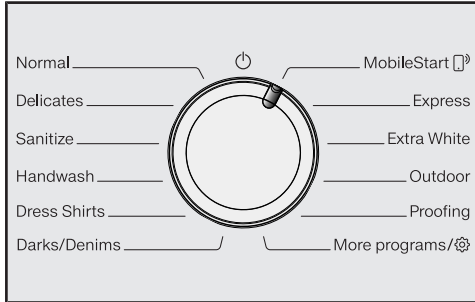

- Turn the program selector to the *MobileStart*  position.

The following appears in the display:

 Load laundry, close the door and press "Start". Appliance can be remotely controlled

- Follow the instructions in the display and start the program.

The following appears in the display:

 MobileStart 

The washing machine can now be operated with the Miele@mobile app.

3. Loading the washing machine

Opening the door

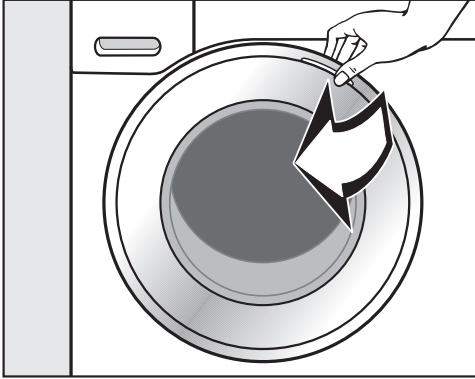

- Take hold of the door and pull it open.

Check the drum for pets or foreign objects before loading it with laundry.

The most efficient use of energy and water is achieved when a full load is washed. However, do not overload as this reduces cleaning efficiency and causes creasing.

- Unfold the laundry and load loosely into the drum.

Mixing both large and small items gives better wash results and also helps distribute the load evenly during spinning.

Tip: Please note the maximum load for different wash programs. The relevant program load is always shown in the display when you select a program.

Closing the door



- Make sure that no items are caught between the door and the seal.

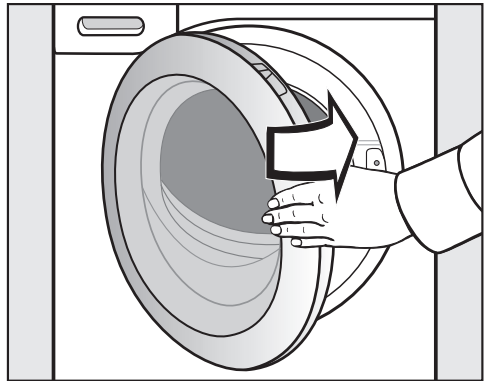

- Shut the door with a gentle swing.

4. Selecting program settings

Selecting a temperature/spin speed

You can alter the pre-set temperature/spin speed of a wash program if this is permitted by the program.

The temperatures reached inside the washing machine might not be the same as the temperatures selected. Perfect wash results are achieved through a combination of energy use and wash duration.

- Touch the ∇/\wedge sensor buttons above or below the temperature or spin speed value in the display until the temperature/spin speed you want appears in the display.

Selecting an extra option

SoftSteam	Pre-wash
Options	Buzzer

- Touch the sensor button for the extra you want. It then lights up brightly.

Tip: You can select multiple extras for a wash program.

Not all the extra options can be used with every program. If an extra option is not dimly lit, this option is not permitted for the wash program (see “Extra options”).

Options sensor button

You can select extra options using the *Options* sensor button.

- Touch the *Options* sensor button.

The following appears in the display:



- Touch the ∇/\wedge sensor buttons until the extra option you want appears in the display.
- Confirm the extra option with the *OK* sensor button.

Degree of soiling

The  sensor button is only active with the TwinDos option activated. See “5. Adding detergent – TwinDos” for more information.

4. Selecting program settings

◆ Delay start/SmartStart

Delay Start

With the Delay Start function, you can delay the start of the program.

This function is active when the setting SmartGrid is switched off.

The hours can be set in the values from 00 to 24. The minutes can be set in 15-minute increments from 00 to 45.

Setting the Delay Start time

- Touch the ◆ sensor button.

The following will appear in the display:



- Set the hours with the ∨∧ sensor buttons. Confirm with the OK sensor button.

The display will change:



- Set the minutes with the ∨∧ sensor buttons. Confirm with the OK sensor button.

Tip: The values will count upward and downward automatically if you keep your finger on the ∨∧ sensor buttons.

Canceling Delay Start

The selected delay-start period can be canceled before the program starts.

- Touch the ◆ sensor button.

The selected delay-start period will appear in the display.

- Set a time value of 00:00 h with the ∨∧ sensor buttons. Confirm with the OK sensor button.

The selected delay-start period has been canceled.

After the program has started, the selected delay-start period can only be changed or canceled by interrupting the program.

Changing Delay Start

The selected delay-start period can be changed before the program starts.

- Touch the ◆ sensor button.
- Change the specified time and confirm with the OK sensor button.

4. Selecting program settings

SmartStart

The SmartStart function lets you define a time period during which your washing machine will start automatically. The start takes place via a signal, e.g., from your energy supplier, that indicates that the electricity rate is particularly economical. Please check with your local utility provider for availability.

This function is active when the SmartGrid setting is switched on.

The time period can be defined between 15 minutes and 24 hours. During this period, the washing machine waits for the signal from the energy supplier. If no signal is sent during the defined period, the washing machine starts the wash program.

Setting the time period

If you have activated the SmartGrid function in Settings, SmartStart instead of Start will appear in the display when you touch the  sensor button (see “Settings – SmartGrid”).

The procedure for setting this is the same as for setting the time for Delay Start.

- Use the ∇/\wedge sensor buttons to enter the hour and confirm your entry with the *OK* sensor button.

The hour will be saved and the minute number block will be highlighted.

- Use the ∇/\wedge sensor buttons to enter the minutes and confirm your entry with the *OK* sensor button.
- Press the *Start/Add laundry* sensor button to start the wash program with SmartStart.

The following will appear in the display:



5. Adding detergent

There are several options for adding detergent to the washing machine.

The washing machine is equipped with the TwinDos system.

TwinDos has to be activated as described in “Before using for the first time”.

The TwinDos system can only be operated with the Miele UltraPhase 1 and UltraPhase 2 Detergents.

How UltraPhase 1 and UltraPhase 2 work

UltraPhase 1 is a liquid detergent which dissolves dirt and removes the most common stains. UltraPhase 2 is a bleaching agent and removes stubborn stains. For the best washing result, these two agents are dispensed at separate times during the washing process. UltraPhase 1 and UltraPhase 2 clean white and colored textiles thoroughly. UltraPhase 1 and UltraPhase 2 single use cartridges are available to order from your Miele dealer or via Miele online store.

Activating TwinDos dispensing

TwinDos dispensing is automatically activated on all programs in which dispensing is possible.

Tip: The detergent dispensing quantities are pre-set. If too much foam builds up, the dispensing quantity for UltraPhase 1 and UltraPhase 2 can be reduced via *More programs*/ TwinDos.

Changing TwinDos dispensing

You can change the suggested color composition of the laundry.

- Touch the *Whites* or *Colors* sensor button.

Deactivating TwinDos dispensing

- Touch the *TwinDos* sensor button.

The sensor button is only dimly lit and dispensing is deactivated.

Using other methods to remove stains



If you use additional methods of stain removal, you have the following options:

- Using the Booster cap and activating the CapDosing
- Using chlorine bleach via the  compartment in the detergent dispenser drawer.

5. Adding detergent

Selecting the degree of soiling

The degree of soiling in laundry is divided into 3 settings:

-  Light
No visible soiling or stains
-  Normal
Visibly soiled and/or just a few slight stains
-  Heavy
Heavily soiled and/or stains clearly visible

The dispensing amount for TwinDos and the amount of water required for rinsing is pre-set for the  Normal degree of soiling.

- Touch the  sensor button to select a different degree of soiling.

The amount of detergent and water will be adjusted to suit the selected degree of soiling.

5. Adding detergent

Detergent dispenser drawer

This washing machine requires high efficiency detergent. Adhere strictly to the dispensing amounts supplied by the detergent manufacturer. The detergents must be marked with the following label:



Ensure that TwinDos dispensing is deactivated.

Filling with detergent

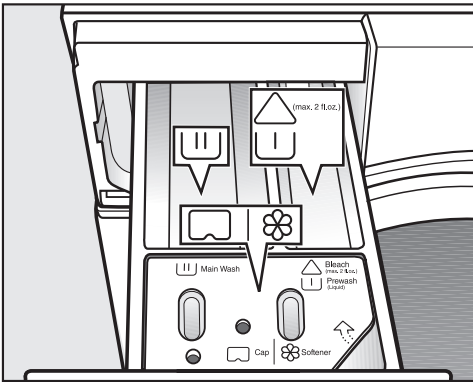

- Pull out the detergent drawer and add detergents to the compartments.

- △ Chlorine bleach for removing stains or liquid detergent for the pre-wash
- U Detergent for the main wash and soaking
- Flower icon Fabric softener, liquid starch, or capsules
- Speech bubble icon capsules

Using chlorine bleach

⚠ Damage due to chlorine bleach. Textiles may be discolored or their fibers damaged. Only use chlorine bleach on suitable textiles.

Chlorination **must** be activated in the settings before chlorine bleach is first used.

Bleach may be used in the following programs:

- Normal
- Sanitize
- Wrinkle-free
- Dress Shirts
- Extra White
- Table Linens/Drapes
- Baby Clothes

Dispensing bleach

Follow the manufacturer's instructions on the packaging.

The *Pre-wash* extra option **must not** be selected.

- Pour **max. 1/4 cup (60 ml)** of bleach into the △ U chamber.

The bleach is added automatically 10 minutes before the end of the main wash.

5. Adding detergent

Adding powder detergent

The detergent dispenser drawer contains an insert for liquid detergent in the  compartment. This insert must be removed to use powder detergent.

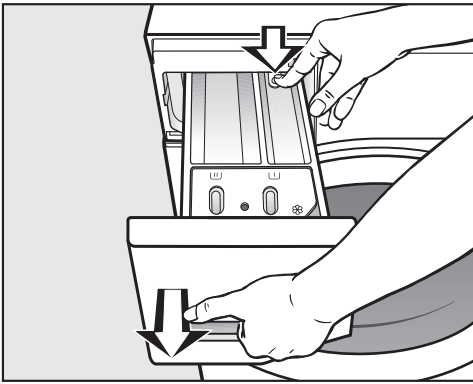

It is **not possible** to use powder detergent in the  compartment.

A pre-wash cannot be carried out when using powder detergent.

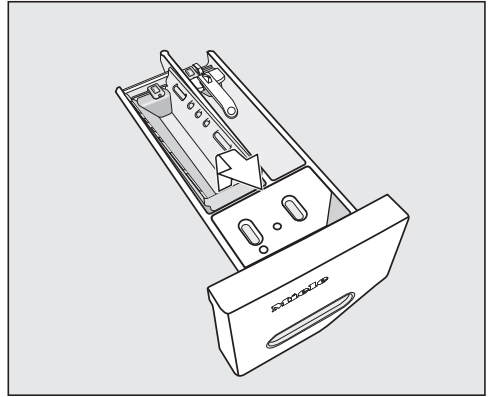

- Remove the detergent dispenser drawer.



- Remove the insert for liquid detergents from the  compartment.
- Replace the detergent dispenser drawer.
- Add powder detergent to the  compartment.

Tip: Reinsert the insert into the detergent dispenser drawer before next using liquid detergent.

Tip: Use TwinDos dispensing if you want to run a program with the *Pre-wash* extra option.

5. Adding detergent

Adding fabric softener

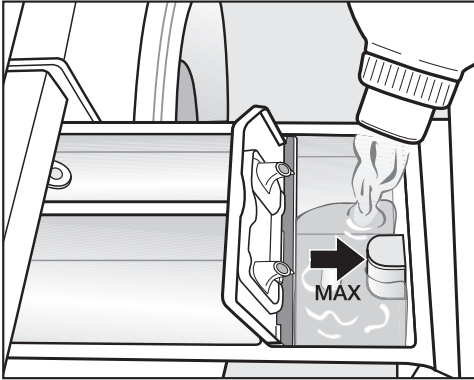

- Add the fabric softener or the liquid starch to the ☼ compartment. **Do not exceed the maximum level mark.**

It will be automatically dispensed in the final rinse cycle. At the end of the program, a small amount of water remains in the ☼ compartment.

If starching frequently, clean the dispenser compartment, especially the siphon, regularly.

Tips for dispensing

Adjust the detergent dosage to the level of soiling of the laundry and the maximum load. Reduce the amount of detergent with smaller loads (e.g., reduce the amount of detergent by $\frac{1}{3}$ when washing a half load).

Too little detergent:

- The laundry is not cleaned properly and may become gray and hard to the touch over time.
- Can lead to a build-up of bacteria in the washing machine.
- Grease is not completely removed from the laundry.
- Can lead to limescale deposits on the heater elements.

Too much detergent

- Poor wash, rinse, and spin results.
- Causes higher water consumption as an extra rinse cycle is automatically activated.
- A greater burden on the environment.

5. Adding detergent

CapDosing

Three different types of capsule are available:

- ☼ = Fabric care (e.g., fabric softener, proofing agent)
- 🧼 = Additives (e.g., detergent enhancers)
- 💧 = Detergent (for the main wash only)

Each capsule contains the correct amount for one wash cycle.

Capsules are available to order from Miele's online store, Miele customer service, or your Miele dealer.

⚠ Capsules pose a health risk. The ingredients of capsules can be hazardous to health if they are swallowed or come into contact with skin. Keep capsules out of the reach of children.

Activating CapDosing

- Touch the **CAP** sensor button.

The following appears in the display:



- Touch the **∨**/**∧** sensor buttons until the capsule you want appears in the display.
- Confirm the capsule with the **OK** sensor button.

Inserting a capsule

- Open the detergent dispenser drawer.

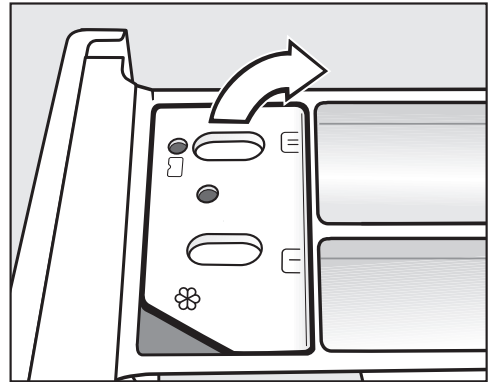

- Open the lid of the ☼/🧼 compartment.

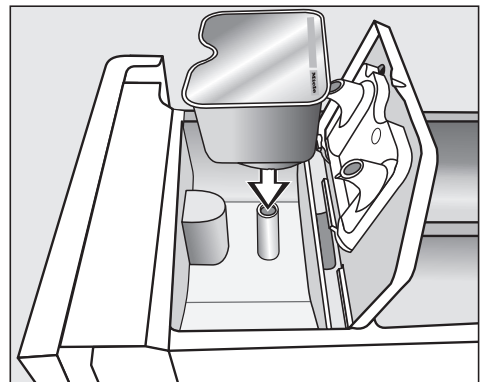

- Press the capsule in firmly.



5. Adding detergent



- Close the lid and press it firmly shut.
- Close the detergent dispenser drawer.

The capsule is opened by the act of inserting it in the detergent dispenser drawer. The contents can run out of the capsule if you then remove it from the drawer before it is used. Dispose of opened capsules.

The contents of the capsule will be added to the wash program at the correct time.

During CapDosing, water intake to the  compartment takes place solely via the capsule. Do not add any additional fabric softener to the  compartment.

- Remove the empty capsule at the end of the wash program.

For technical reasons, a small amount of water will remain in the capsule.

Deactivating or changing CapDosing

CapDosing can only be deactivated or changed prior to program start.

- Touch the  sensor button.
- Select No Cap (deactivate) or a different type of capsule (change).

Color run and dye removers

 Damage due to color run/dye removers.

Color run and dye removers can cause corrosion in the washing machine.

Do not use color run or dye removers in the washing machine.

Dyes suitable for use in domestic washing machines can be used. However, please note that the salt used in the dyeing process can cause corrosion to stainless steel components in the machine if you use dye frequently. Always observe the dye manufacturer's instructions carefully.

6. Starting a program

- Touch the flashing *Start/Add laundry* sensor button.

The door will lock and the wash program will start.

The program status will appear in the display.

The washing machine will keep you updated on the program status and the time remaining for the program to run.

If a delay-start period has been selected, this will appear in the display.

Energy savings

After 10 minutes, the indicators dim. The *Start/Add laundry* sensor button flashes.

You can reactivate the indicators:

- Touch the *Start/Add laundry* sensor button (this does not have any effect on a program that is running).

Adding laundry during a program sequence (AddLoad)

Laundry can be added or removed at any time, provided that the  symbol is not illuminated in the display.

- Touch the *Start/Add laundry* sensor button.

The following appears in the display:

 Please wait

- Wait until the following display lights up:

 Door can be opened

- Open the door and add or remove laundry.
- Close the door.
- Touch the *Start/Add laundry* sensor button.

The wash program will continue.

Laundry cannot usually be added or removed if:

- The suds temperature is above 130°F (55°C).
- The water inside the drum is above a certain level.

7. Program end

Opening the door and removing the laundry

The door remains locked during the Anti-crease phase. The display will change to show:

End/Anti-Crease

i Press Start button

- Unlock the door either by touching the *Start/Add laundry* sensor button or by turning the program selector to the  position.

The door will be unlocked.

Tip: After the Anti-crease phase, the door will unlock automatically.

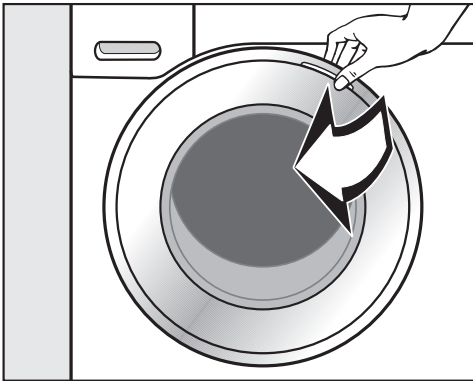

- Take hold of the door and pull it open.
- Remove the laundry.

Items left in the drum could discolor other items in the next wash or become discolored themselves. Remove all items from the drum.

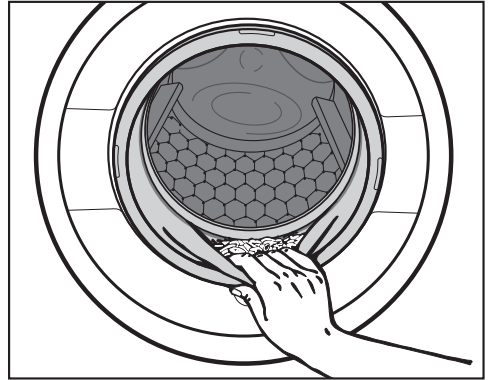

- Check the folds in the door seal for any foreign objects.

Tip: Leave the door slightly open to allow the drum to dry.

- If applicable, remove the used capsule from the detergent dispenser drawer.

Tip: Leave the detergent dispenser drawer slightly open to allow it to dry.

Spin cycle

Final spin speed

Program	Selectable spin speeds in words and numbers (rpm)					
	Max 1,600	High 1,200	Med 800	Slow 600		 0
Normal	✓	–	–	–	X	X
Delicates	–	–	✓	X	X	X
Sanitize	✓	X	–	–	X	X
Handwash	–	✓	X	X	X	X
Dress Shirts	–	–	✓	X	X	X
Darks/Denims	–	✓	X	X	X	X
Express	–	✓	X	X	X	X
Extra White	✓	X	–	–	X	X
Outdoor	–	–	✓	X	X	X
Proofing	–	X	✓	X	X	X
Table Linens/Drapes	–	✓	X	X	X	X
Sportswear	–	✓	X	X	X	X
Woolens 	–	✓	X	X	–	X
Silks 	–	–	–	✓	X	X
Wrinkle-free	–	✓	X	X	X	X
Drain/Spin	✓	X	X	X	–	X
Quick Rinse	✓	X	X	X	X	X
Baby Clothes	✓	X	X	X	X	X
Towels	✓	X	X	X	X	X
Downs	–	✓	X	X	X	X
Pillows	–	✓	X	X	X	X
Clean Machine	–	–	–	X	–	–

✓ = optimum spin speed for program is pre-set

X = can be selected – = cannot be selected

Final spin speed in the wash program

When a program is selected, the optimum spin speed for the wash program is always shown in the display.

A faster spin speed can be selected for certain wash programs.

The highest selectable spin speed is indicated in the table.

Omitting the final spin (Rinse hold)

- Set the spin speed to  (Rinse hold).

The laundry is not spun after the final rinse and remains in the rinse water. This helps prevent creasing if the laundry is not going to be removed from the drum immediately after the end of the program.

Ending a program with a spin cycle

The display shows  Rinse hold alternately with the ideal spin speed.

- Touch the *Start/Add laundry* sensor button to start the final spin.

Ending a program without a spin cycle

- Reduce the spin speed to 0.
- Touch the flashing *Start/Add laundry* sensor button.

Rinse-spin

There is a spin cycle after the main wash and between the rinse cycles. A reduction in the final spin speed will also reduce the interim spin speed as appropriate.

Omitting the rinse-spin and final spin











- Before the start of the wash program, reduce the spin speed to 0.

After the last rinse cycle, the water will be pumped away and the Anti-crease phase will switch on.











An Extra Rinse cycle is carried out with this setting for certain wash programs.

Program guide



Programs on the program selector

Temperature with garment care label symbols			Item/Tip
Normal			Full load (17.6 lb/8 kg)
Hot +	140°F/60°C		Cotton, linen, and mixed fibre textiles made of both cotton and linen.
Hot	120°F/50°C		
Warm + ✓	105°F/40°C		
Warm	85°F/30°C		
Cold	Cold		
USA test program in accordance with: DOE Federal Register 10 CFR Part 430 Appendix J2 to subpart B Canada test program in accordance with: CAN/CSA-C360-13			
Delicates			Small load (6.6 lb/3 kg)
Hot +	140°F/60°C		For fine textiles made from synthetic fibers.
Hot	120°F/50°C		
Warm + ✓	105°F/40°C		
Warm	85°F/30°C		
Cold	Cold		
Sanitize			Full load (17.6 lb/8 kg)
Sanitize ✓	170°F/75°C		Cotton or linen fabrics with direct skin contact or for which special hygiene requirements apply.
Handwash			Small load (4.4 lb/2 kg)
Warm + ✓	105°F/40°C		For fine textiles which are only suitable for hand washing.
Warm	85°F/30°C		
Cold	Cold		













Program guide

Temperature with garment care label symbols			Item/Tip
Dress Shirts			Small load (4.4 lb/2 kg)
Hot +	140°F/60°C		Pre-treat collars and cuffs depending on the level of soiling. Wash silk shirts and blouses in the <i>Silks</i>  program.
Hot	120°F/50°C		
Warm + ✓	105°F/40°C		
Warm	85°F/30°C		
Cold	Cold		
Darks/Denims			Small load (4.4 lb/2 kg)
Warm + ✓	105°F/40°C		Black and dark garments made from cotton, mixed fibers, and denim. - Wash inside out. - Denim often contains excess dye and may run during the first few washes. Therefore, wash light and colored items separately.
Warm	85°F/30°C		
Cold	Cold		
MobileStart 			
The Miele@mobile app is used to select the programs and operate the appliance.			
Express			Half load (7.7 lb/3.5 kg)
Warm +	105°F/40°C		Cotton textiles that have hardly been worn or are only very lightly soiled. Selecting the  Light level of soiling will reduce the washing time by 10 minutes.
Warm ✓	85°F/30°C		
Cold	Cold		









Program guide

Temperature with garment care label symbols		Item/Tip	
Extra White		Full load (17.6 lb/8 kg)	
Hot + ✓	140°F/60°C		For white textiles made of cotton or linen without special hygiene requirements.
Outdoor		Small load (5.5 lb/2.5 kg)	
Warm + ✓	105°F/40°C		Performance outerwear (e.g., jackets and trousers) made from membrane fabric. <ul style="list-style-type: none"> - Zip up or close any jackets with Velcro before washing. - Do not use fabric softener. - If required, these garments can also be re-proofed using the <i>Proofing</i> program. Reproofing after each wash cycle is not recommended.
Warm	85°F/30°C		
Cold	Cold		
Proofing		Small load (5.5 lb/2.5 kg)	
Warm + ✓	105°F/40°C		Treating microfiber fabric, ski wear, or Table Linens made from mainly synthetic fibers to provide a finish which is resistant to water and dirt. <ul style="list-style-type: none"> - The items should be freshly laundered and spun or dried before proofing. - For best results, the items should be heat-treated afterwards, either in a tumble dryer or by ironing.













Programs positioned on the More programs/ program selector

Temperature with garment care label symbols		Item/Tip	
Table Linens/Drapes			Full load (13.2 lb/6 kg)
Hot +	140°F/60°C		Table Linens and drapes made of cotton and linen.
Hot	120°F/50°C		
Warm + ✓	105°F/40°C		
Warm	85°F/30°C		
Cold	Cold		
Sportswear			Half load (6.6 lb/3 kg)
Hot +	140°F/60°C		Sportswear such as jerseys and leggings, as well as microfiber and fleece garments. - Do not use fabric softener. - Observe the manufacturer's care label.
Hot	120°F/50°C		
Warm + ✓	105°F/40°C		
Warm	85°F/30°C		
Cold	Cold		
Woolens 			Small load (4.4 lb/2 kg)
Warm ✓	85°F/30°C		Wool or wool-blend textiles. Reduce the final spin speed for items which crease easily.
Cold	Cold		
Silks 			Very small load (2.2 lb/1 kg)
Warm ✓	85°F/30°C		Silks and other hand-washable textiles with no wool content. Place tights, bras, etc., in a washing bag.
Cold	Cold		

Program guide

Temperature with garment care label symbols			Item/Tip
Wrinkle-free			Half load (8.8 lb/4 kg)
Hot +	140°F/60°C		Synthetic or mixed fibre fabric, or easy care cotton.
Hot	120°F/50°C		
Warm + ✓	105°F/40°C		
Warm	85°F/30°C		
Cold	Cold		
Drain/Spin			Full load (17.6 lb/8 kg)
<ul style="list-style-type: none"> - Drain only: Set spin speed to No . - Make sure you select the appropriate spin speed. 			
Quick Rinse			Full load (17.6 lb/8 kg)
<p>For rinsing hand-washed items.</p> <p>Reduce the final spin speed for items which crease easily.</p>			
Baby Clothes			Full load (13.2 lb/6 kg)
Hot +	140°F/60°C		Baby clothes, baby towels and bibs made from cotton.
Hot	120°F/50°C		
Warm + ✓	105°F/40°C		
Warm	85°F/30°C		
Cold	Cold		

Program guide

Temperature with garment care label symbols			Item/Tip
Towels			Full load (11 lb/5 kg)
Hot +	140°F/60°C		For linen or cotton towels.
Hot	120°F/50°C		
Warm +	105°F/40°C		
Warm ✓	85°F/30°C		
Cold	Cold		
Downs			Small load (4.4 lb/2 kg)
Hot +	140°F/60°C		Jackets, sleeping bags, pillows, and other Down Filled Items. - Remove air from the laundry before washing to prevent an excessive build-up of foam. To do this, either push the items into a narrow laundry bag to compress them or tie the items together with a washable strap. - Please observe the instructions on the wash care label.
Hot	120°F/50°C		
Warm + ✓	105°F/40°C		
Warm	85°F/30°C		
Cold	65°F/15°C		
Pillows			2 pillows 16" x 32" (40 x 80 cm) or 1 pillow 32" x 32" (80 x 80 cm)
Hot +	140°F/60°C		Synthetic-filled washable pillows - Remove air from the laundry before washing to prevent an excessive build-up of foam. To do this, either push the items into a narrow laundry bag to compress them or tie the items together with a washable strap. - Please observe the instructions on the wash care label.
Hot	120°F/50°C		
Warm + ✓	105°F/40°C		
Warm	85°F/30°C		
Cold	65°F/15°C		

Program guide

Settings /maintenance

Settings

You can use the settings to alter the washing machine's electronics to suit changing requirements. See “Settings” for more detailed information.

Maintenance

The washing machine has two maintenance programs.

1. Clean Machine for cleaning the washing machine.
2. TwinDos Care for maintenance of the ①/② TwinDos compartments. See “Cleaning and care – TwinDos maintenance” for more details.

Temperature with garment care label symbols		Item/Tip
Clean Machine		Without load
Sanitize ✓	170 °F/75 °C	<p>With frequent washing at low temperatures there is a danger of a build-up of bacteria in the washing machine.</p> <p>Cleaning the washing machine will significantly reduce bacteria and prevent the build-up of unpleasant odors.</p> <ul style="list-style-type: none">- Dispense the universal detergent directly into the drum.- Do not load machine. The drum must be empty for the maintenance wash.

You can supplement the wash programs with extra options.

Selecting extra options

Extra options are selected or deselected using the sensor buttons in the control field. Additional extra options can be selected on the display using the *Extras* sensor button.

SoftSteam	Pre-wash
Options	Buzzer

- Touch the sensor button for the extra option you want.





The relevant button will light up brightly.

Not all the extra options can be used with every program.

An extra option that is not permitted for the wash program is not lit dimly and cannot be activated by touch.

SoftSteam

In order to reduce creasing, the laundry undergoes a smoothing process at the end of the program. Reducing the maximum load by 50% will give a better result. Please note the load information in the display. Small loads achieve a better result.



The garments must be suitable for drying in a tumble dryer   and suitable for ironing  .



Pre-wash

For laundry with large amounts of dirt, e.g., dust and sand.

Pre-wash **cannot** be combined with the use of chlorine bleach.

The chlorine bleach is added too early.

Only liquid detergent may be added to the   chamber of the detergent dispenser drawer.

Powder detergent clogs up the   chamber and water can escape from the detergent dispenser drawer.

Buzzer

A buzzer sounds at the end of the program. The buzzer sounds until the washing machine is switched off. The volume of the buzzer can be changed, see “Settings – Buzzer”.

Extra options

Extra options can be selected using the Options sensor button

Selecting extra options in the display

- Touch the Options sensor button.

The following will appear in the display:

No Extras

- Touch the \vee/\wedge sensor buttons until the extra option you want appears in the display.

- Confirm the extra option with the OK sensor button.

The extra option has a \checkmark next to it.

Deselecting an extra option

- Touch the *Options* sensor button.

The first extra option which can be selected appears in the display.

- Touch the \vee/\wedge sensor buttons until No Extras appears in the display.
- Confirm No Extras with the OK sensor button.

The previously selected extra option is now deselected.

Extra Gentle

Drum rotation and wash duration is reduced. Lightly soiled textiles are washed more gently.

ExtraRinse

An extra rinse can be activated to achieve a more thorough wash result.





Soak

For heavily soiled and stained items with protein stains.

A soak duration of between 30 minutes and 6 hours in 30-minute increments can be selected for the soak process. See “Settings” for more information.

The factory default setting is 30 minutes.

AllergyWash

This option should be used where high standards of hygiene are required. Energy consumption is increased to lengthen temperature holding times and water consumption is increased to improve rinsing efficiency. The items must be suitable for drying in a tumble dryer   and suitable for ironing  .

Wash program overview – extra options



	SoftSteam	Pre-wash	Buzzer	Soak	Gentle	AllergyWash	ExtraRinse
Normal	-	●	●	●	●	-	●
Delicates	●	●	●	●	●	-	●
Sanitize	●	●	●	●	●	●	●
Handwash	-	-	●	-	-	-	-
Dress Shirts	✓	●	●	●	●	-	●
Darks/Denims	●	●	●	●	●	-	●
Express	-	-	●	-	-	-	-
Extra White	●	●	●	●	●	●	●
Outdoor	-	●	●	●	-	-	-
Proofing	-	-	●	-	-	-	-
Table Linens/Drapes	●	●	●	●	●	-	●
Sportswear	●	●	●	●	-	-	●
Woolens 	-	-	●	-	-	-	-
Silks 	-	-	●	-	-	-	-
Wrinkle-free	●	●	●	●	●	-	●
Drain/Spin	-	-	●	-	-	-	-
Quick Rinse	●	-	●	-	-	-	-
Baby Clothes	●	●	●	●	●	-	●
Towels	-	●	●	-	-	-	●
Downs	-	●	●	-	-	-	●
Pillows	-	●	●	-	-	●	●

● = Can be selected

✓ = Activated automatically

- = Cannot be selected

Program sequence

	Main wash		Rinses		Spin cycle
	Water level	Wash rhythm	Water level	Rinses	
Normal		(A)		2-3 ^{1,2}	✓
Delicates		(C)		2-4 ^{1,2}	✓
Sanitize		(A)		3-4 ^{1,2}	✓
Handwash		(E)		2	✓
Dress Shirts		(C)		3-4 ²	✓
Darks/Denims		(B)		3-5 ^{1,2}	✓
Express		(A)		2	✓
Extra White		(A)		2-5 ^{1,2}	✓
Outdoor		(C)		3-4 ²	✓
Proofing	-	(B)		1	✓
Table Linens/Drapes		(A)		2-3 ^{1,2}	✓
Sportswear		(C)		2-3 ²	✓
Woolens 		(E)		2	✓
Silks 		(E)		2	✓
Wrinkle-free		(B)		2-4 ^{1,2}	✓
Drain/Spin	-	-	-	-	✓
Quick Rinse	-	-		2	✓
Baby Clothes		(A)		2-3 ^{1,2}	✓
Towels		(A)		2-5 ^{1,2}	✓
Downs ³		(C)		3-4 ²	✓
Pillows ³		(C)		3-4 ²	✓

Please see the next page for a description of the symbols.

 = low water level

 = medium water level

 = high water level

Ⓐ = intensive rhythm

Ⓑ = normal rhythm

Ⓒ = sensitive rhythm

Ⓓ = ultra sensitive rhythm

Ⓔ = handwash rhythm

✓ = carried out

- = not carried out



This washing machine has fully electronic controls with automatic load control. The washing machine takes in the right amount of water required for the program depending on the amount of laundry and its absorbency rate.

The program sequences outlined in the chart are based on the basic program with a full load.

Special features in the program sequence

Anti-crease:

At the end of the program, the drum continues to turn at intervals for up to 30 minutes to help prevent creasing.

Exception: There is no anti-crease phase in the *Woolens* , *Silks*  and *Handwash* programs.

The washing machine can be opened at any time.

¹ An additional rinse is carried out if:

- there is too much foam in the drum
- a spin speed lower than *Medium* (800 rpm) has been selected.

² An additional rinse is carried out if the *ExtraRinse* extra option has been selected.

³ Run-up to spin: A run-up to spin is carried out before the wash process begins to deflate down-filled items. Subsequent water intake for the main wash is through compartment .

Changing the program sequence

Changing a program (safety lock)

A program, temperature, spin speed, or selected extra options cannot be changed once the machine has been successfully started. This prevents the machine being operated unintentionally, e.g., by children.

If the washing machine is switched off during active program operation, the standby function does not switch the washing machine off completely after 15 minutes. Safety functions continue to be active because there may still be water inside the drum.

Interrupting a program

- Turn the program selector to the  position.
- To continue, turn the program selector to the position of the wash program that was started.



- Touch the  sensor button.

The following will appear in the display:



- Confirm with the *OK* sensor button.

Tip: If  Change not possible appears in the display, the program selector is in the incorrect position.

Canceling a program

You can cancel a wash program at any time after it has started.

- Turn the program selector to the  position.
- Turn the program selector to the *Normal* program.

The following will appear in the display:



- Touch the *OK* sensor button.





The suds are pumped away. The following will appear in the display:



- Wait until the  symbol in the display goes out and the door unlocks.
- Pull open the door.
- Remove the laundry.

Detergents recommended by Miele

Miele Detergents have been specially designed for day-to-day use in Miele Washing Machines. See “Detergents and care products” for more information about these detergents.

	Miele UltraPhase 1 and 2	Miele Capsules		
				
Normal	✓	-	✓	✓
Delicates	✓	✓	✓	-
Sanitize	✓	-	✓	✓
Handwash	-	✓	✓	-
Dress Shirts	✓	-	✓	✓
Darks/Denims	✓	-	✓	-
Express	✓	-	✓	-
Extra White	✓	-	✓	✓
Outdoor	-	✓	-	-
Proofing	-	-	✓	-
Table Linens/Drapes	✓	-	✓	✓
Sportswear	-	✓	-	-
Woolens 	-	✓	-	-
Silks 	-	✓	-	-
Wrinkle-free	✓	-	✓	✓
Quick Rinse	-	-	✓	-
Baby Clothes	✓	-	✓	✓
Towels	✓	-	✓	✓
Downs	-	✓	-	-
Pillows	✓	-	-	-

✓ Recommendation

- No recommendation

 Special-purpose detergents (e.g., WoolCare)

 Fabric care (e.g., fabric softener)

 Additives (e.g., booster)

Detergent

General detergent recommendations

The wash programs that are not listed do not have a detergent recommendation

	Universal detergent	Color detergent	Detergent for Woolens and delicates	Bleach ¹
Normal	✓	✓	-	✓
Delicates	-	-	✓	-
Sanitize	✓	✓	-	✓
Handwash	-	-	✓	-
Dress Shirts	✓	✓	-	✓
Darks/Denims	-	✓	✓	-
Express	-	✓ ²	-	-
Extra White	✓	-	-	✓
Outdoor	-	-	✓	-
Table Linens/ Drapes	✓	✓	-	✓
Sportswear	-	-	✓	-
Woolens 🧶	-	-	✓	-
Silks 🧶	-	-	✓	-
Wrinkle-free	✓	✓	-	✓
Baby Clothes	✓	✓	-	✓
Towels	✓	✓	-	-
Downs	-	-	✓ ²	-
Pillows	-	-	✓ ²	-
Clean Machine	✓ ³	-	-	-

✓ Recommended

- Not recommended

1 If the “Bleach” setting has been activated

2 Liquid detergent

3 Powder detergent

Replacing the TwinDos cartridge

A message will appear in your washing machine display if a detergent cartridge is empty.

A message will appear in your washing machine display if a detergent cartridge is empty.

Preparing the cartridge

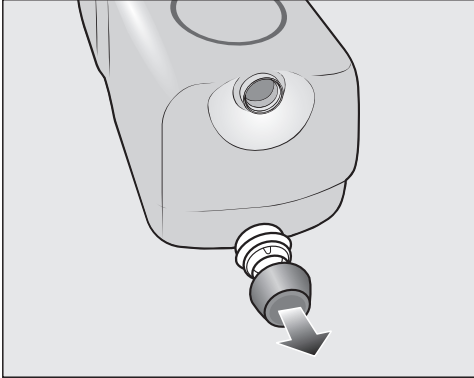

- Remove the cover cap from the cartridge.

or

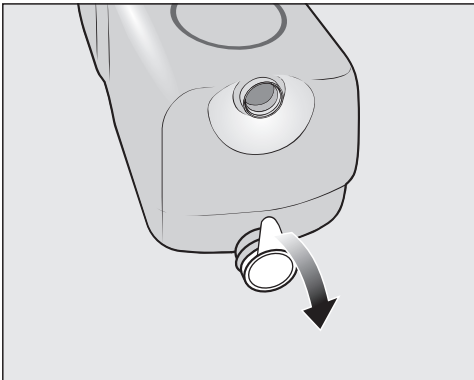

- Remove the film seal from the cartridge completely.

⚠ Risk of damage from film seal
If the film seal is not removed completely, leaks can occur in the TwinDos system.

Remove the film seal from the suction port on the cartridge completely before inserting the new cartridge.

Replacing the cartridge

- Switch on the washing machine.

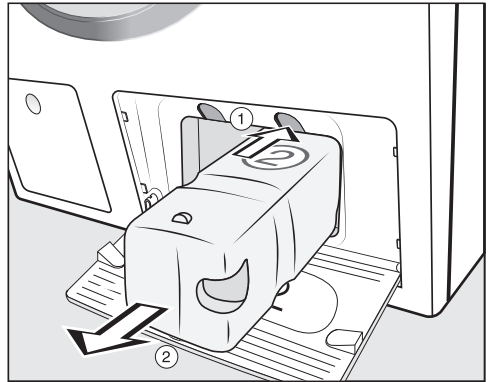

① To release the lock, press the yellow button above the cartridge.

② Remove the cartridge.

- Insert a new cartridge.

- Confirm the messages in the display.

The counter is set to 0.

Cleaning and care

Cleaning the housing and control panel

⚠ Risk of electric shock.
Mains voltage is present when the washing machine is switched off
Disconnect the machine from the electricity supply before cleaning or maintenance.

⚠ Risk of damage due to ingress of water.

The pressure of a water jet can cause water to get into the washing machine, resulting in damage to components.

Do not spray the washing machine with a water jet when hosing down.

- Clean the housing and control panel with a mild cleaning agent or soap and water and dry both with a soft cloth.
- The drum can be cleaned using a suitable stainless steel cleaning agent following the manufacturer's instructions on the packaging.

⚠ Damage due to cleaning agents.
Do not use solvents, abrasive cleaners, glass cleaners or all-purpose cleaning agents. These might damage plastic surfaces and other components because of the chemicals they contain.
Do not use any of these cleaning agents.

Cleaning the detergent dispensing drawer

Washing at low temperatures and the use of liquid detergent can lead to a build-up of bacteria in the detergent dispensing drawer.

- Clean the entire drawer at regular intervals for hygiene reasons, even if you are using the TwinDos system exclusively.

Removing the detergent dispenser drawer

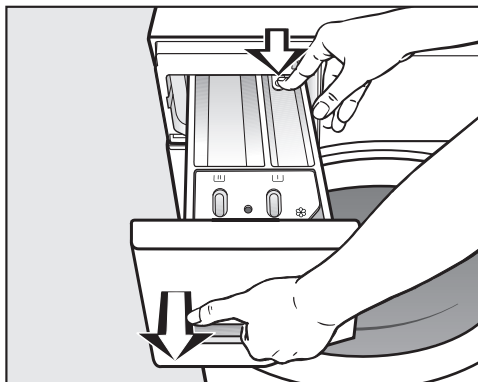

- Pull out the detergent dispenser drawer until a resistance is felt. Press down the release button and at the same time pull the drawer right out of the machine.

Removing and cleaning the insert for liquid detergents

An insert for liquid detergents is located in the  compartment of the detergent dispenser drawer.

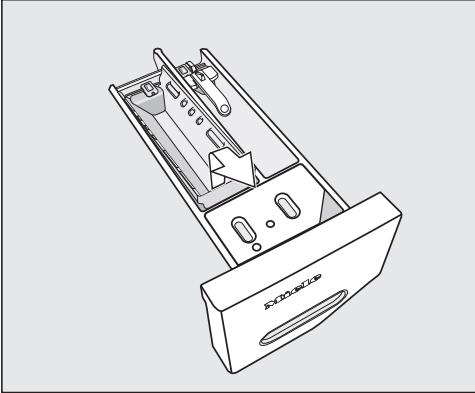

- Remove the insert. Clean the insert thoroughly with warm water.

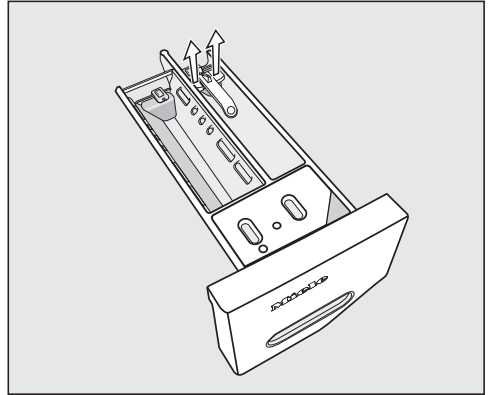

Cleaning the compartment

Compartment 1 has a siphon for better dispensing of the chlorine bleach.



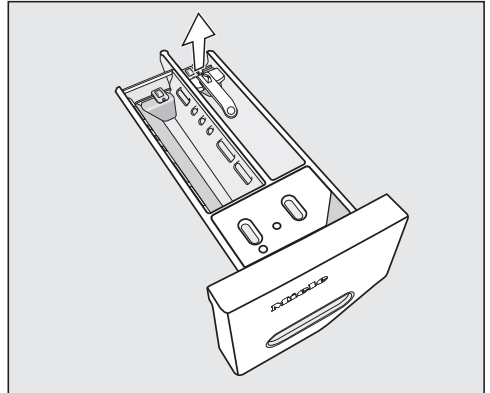

- Remove the release catch.



- Remove and clean the siphon.
- Clean the   and  compartments with warm water.

Cleaning and care

Cleaning the siphon and the compartment channel

Liquid starch results in clogging. The siphon in the   compartment no longer works and the compartment can overflow.

Clean the siphon particularly thoroughly after using liquid starch a few times.

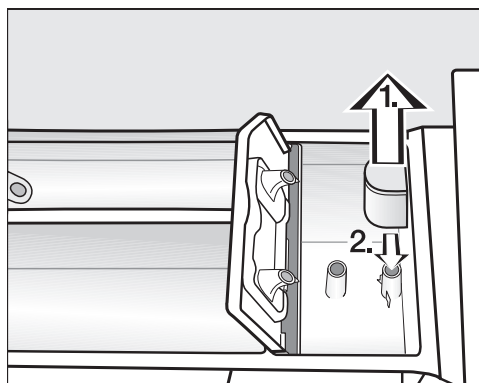

1. Remove the siphon from the  compartment and clean under warm running water. Clean the siphon tube in the same way.
2. Refit the siphon.

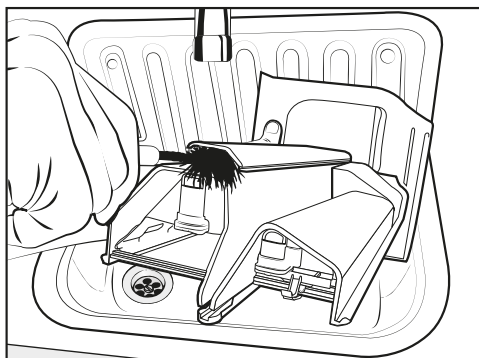

- Clean the fabric softener channel with a brush and warm water.

Cleaning the detergent dispenser drawer housing



- Use a bottle brush to remove detergent residues and limescale from the jets inside the detergent dispenser drawer housing.
- Replace the detergent dispenser drawer.

Tip: Leave the detergent dispenser drawer slightly open to allow it to dry.

TwinDos maintenance

 Damage resulting from dried laundry detergent.

If the system has not been used for a long time (more than 2 months), detergent in the hoses can become viscous or dry out. The hoses can become blocked and would then need to be cleaned by Customer Service.

Clean the TwinDos system.

To clean the system, you either need a “TwinDosCare” cleaning cartridge or an empty TwinDos container, available from www.shop.miele.com.

The washing machine has a cleaning program for the TwinDos system. Running the cleaning program will clean the hoses inside the washing machine.

Starting the maintenance program

- Turn the program selector to the *Additional programs*/ position.



- Touch the ∇/\wedge sensor buttons until the following appears in the display:



- Confirm the setting with the *OK* sensor button.
- Touch the ∇/\wedge sensor buttons until the following appears in the display:



- Confirm the setting with the *OK* sensor button.



- Touch the ∇/\wedge sensor buttons until the compartment you want appears in the display. Confirm with the *OK* sensor button.



- Touch the ∇ sensor button until the following appears in the display:



- Confirm the setting with the *OK* sensor button.
- Follow the instructions in the display.

The hoses will now be cleaned. The TwinDos system can be used again at any time.

Cleaning the removable compartment

Detergent residue can cause clogging.

- Use a damp cloth to clean the compartment interior when you change the cartridges or container.

Cleaning and care

Sanitize info (Cleaning the drum)

Washing at low temperatures and/or using liquid detergents can cause bacteria and odors to build up in the washing machine. Use the *Clean Machine* program to clean the washing machine. Note the message in the display:

Sanitize info: Run a high temp. program or the "Clean Machine" program

Cleaning the water-inlet filter

The washing machine has 2 filters to protect the inlet valve. Check these filters every 6 months or so. Check the filters more often if there are frequent interruptions to the external water supply.

Cleaning the filter in the inlet hose

- First turn off the faucet.
- Unscrew the inlet hose from the faucet.

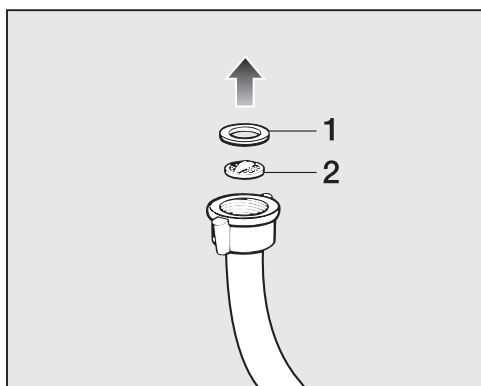

- Remove the rubber seal **1** from the connector.

- Using needle nose pliers, take hold of the plastic filter bar **2** and remove the plastic filter.
- Clean the filter.
- Reassemble in reverse order.

Cleaning the filter in the inlet valve

- Using pliers, carefully loosen the ribbed plastic nut on the inlet valve and unscrew.

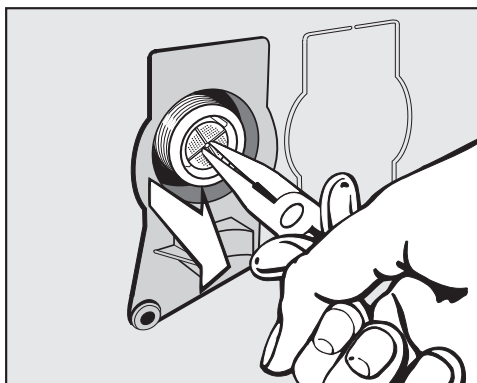

- Use needle nose pliers to withdraw the filter by the bar.
- Clean the filter.
- Reassemble in reverse order.

The filters must be put back in place after cleaning.

- Screw the screw thread securely back onto the faucet.
- Turn on the water-supply faucet.

Make sure there is no water leaking from the screw thread.
Tighten the screw thread.



Frequently Asked Questions

With the help of the following guide minor faults in the performance of the machine, some of which may result from incorrect operation, can be remedied without contacting the Service Department.

This guide may help you to find the reason for the fault, and how to correct it.









Some of the messages in the display are more than one line long. Touch the \vee or \wedge sensor button to read them in full.

A wash program cannot be started

Problem	Possible cause and solution
The control field remains dark.	There is no power to the machine. <ul style="list-style-type: none">■ Check whether the plug is plugged in.■ Check whether the fuse has tripped.
	The washing machine has switched off automatically to save energy. <ul style="list-style-type: none">■ Switch the washing machine on again by turning the program selector.
The display prompts you to enter a code.	The PIN code is active. <ul style="list-style-type: none">■ Enter the code and confirm the entry. Deactivate the PIN code if you do not wish this message to appear in the display the next time the machine is switched on.
The following appears in the display:   Service Door lock fault F34	The door is not closed properly. The door lock could not engage. <ul style="list-style-type: none">■ Close the door again.■ Start the program again. If the fault message appears again, contact Miele Customer Service.

Frequently Asked Questions

Fault message after a program has been interrupted

Problem	Possible cause and solution
 Drainage See 	<p>The drain is blocked or restricted. The drain hose has been fixed too high.</p> <ul style="list-style-type: none"> ■ Clean the drain filter and the drain pump. ■ The maximum drain height is 39 $\frac{3}{8}$" (1 m).
 Water intake See 	<p>Water intake is blocked or restricted.</p> <ul style="list-style-type: none"> ■ Check whether the faucet is turned on properly. ■ Check whether the intake hose is kinked. ■ Check whether there is sufficient water pressure.
	<p>The filter in the water intake is blocked.</p> <ul style="list-style-type: none"> ■ Clean the filter.
	<p>The drain pump is activated for 2 minutes. The washing machine door is then released. Wait for the drain pump to stop before switching the machine off.</p>
 Waterproof system Turn off   Service	<p>The water protection system has reacted.</p> <ul style="list-style-type: none"> ■ Close the faucet. ■ Contact Customer Service.
  Service Fault F	<p>There is a fault.</p> <ul style="list-style-type: none"> ■ Disconnect the washing machine from the power supply. Unplug the appliance or switch off the breaker. ■ Wait at least 2 minutes before reconnecting the washing machine to the power supply. ■ Switch the washing machine on again. ■ Restart the program. <p>If the fault message appears again, contact Miele Customer Service.</p>

To switch off the fault indicator: Turn the program selector to the  position and switch the washing machine off.

Frequently Asked Questions



Fault message after the end of the program

Problem	Possible cause and solution
<p>i Check dosage</p>	<p>Excessive foam has built up during washing.</p> <ul style="list-style-type: none"> ■ With TwinDos, check the dosage amount set. ■ Reduce the amount set in 10% increments. ■ Use less detergent next time and follow the manufacturer's instructions on dosage given on the packaging.
<p>i Sanitize info: Run a high temp. program or the "Clean Machine" program</p>	<p>When washing, a wash program using a temperature above 140°F (60°C) has not been run for a long time.</p> <ul style="list-style-type: none"> ■ Turn the program selector to <i>Additional programs/</i> . ■ Touch the $\wedge \vee$ sensor buttons until Maintenance appears in the display. ■ Touch the OK sensor button. <p>The following appears in the display: Clean Machine</p> <ul style="list-style-type: none"> ■ Touch the OK sensor button. ■ Run the Clean Machine program using a universal powder detergent. <p>The washing machine is cleaned which prevents bacteria and odor buildup.</p>
<p>i Align the washing machine</p>	<p>The <i>SoftSteam</i> extra option which runs at the end of the program could not be carried out properly.</p> <ul style="list-style-type: none"> ■ Check whether the washing machine is aligned correctly (see "Installation – Leveling the machine"). ■ Check whether the maximum drain height of 3' 3" (1 m) has been exceeded. <p>If the fault message appears again, contact Miele Customer Service. The washing machine can still be used, but without the <i>SoftSteam</i> extra option.</p>

The messages will appear at the end of the program and when the washing machine is switched on, and need to be confirmed with the OK sensor button.

Frequently Asked Questions

Messages or faults affecting the TwinDos system

Problem	Possible cause and solution
i ① is almost empty. Only a few more cycles are possible	The detergent in the cartridge is running low. There is enough left for approx. 4 to 8 wash programs. ■ Order a new cartridge.
i TwinDos ① is empty. Check wash results	The cartridge is empty. ■ Replace the cartridge. ■ Check if the laundry is clean. There may not have been enough detergent. If there was not enough detergent, wash the laundry again.
i Use "TwinDos" or start Care. See 	TwinDos dispensing via compartment ① and/or ② has not been used for a long time. ■ Use TwinDos for one of your next wash cycles. ■ Carry out the TwinDos maintenance program as described in "Cleaning and care – TwinDos maintenance".
 TwinDos Care for compartment ① and compartment ② must be started. See 	TwinDos dispensing via compartment ① and/or ② has not been used for too long a time. It is possible that detergent has dried inside the hoses. ■ Immediately carry out the TwinDos maintenance program as described in "Cleaning and care – TwinDos maintenance".
The messages shown on this page are examples. They may differ depending on whether they refer to compartment ① or ②.	

The messages will appear at the end of the program and when the washing machine is switched on, and need to be confirmed with the *OK* sensor button.

Frequently Asked Questions

Messages or faults affecting the TwinDos system

Problem	Possible cause and solution
No detergent was dispensed during washing.	TwinDos is deactivated. ■ Before the next wash program, ensure that the <i>TwinDos</i> sensor button is lit.
	Detergent is not dispensed even though the <i>TwinDos</i> sensor button is lit. ■ Try again. ■ If detergent is still not dispensed, contact Miele Customer Service.
A new detergent cartridge has been inserted, but the cartridge is identified as empty when the machine is switched on.	The washing machine was switched off when the detergent cartridge was replaced. ■ Switch on the washing machine. ■ Remove the detergent cartridge and then reinsert it into the compartment. The counter is set to 0.



Frequently Asked Questions

General problems with the washer

Problem	Possible cause and solution
The washing machine is emitting an odor.	<p>The Sanitize info was not observed. When washing, a wash program using a temperature above 60°C (140°F) has not been run for a long time.</p> <ul style="list-style-type: none">■ Run the <i>Clean Machine</i> program using a universal powder detergent. <p>The washing machine is cleaned which prevents bacteria and odor buildup.</p> <p>The door and detergent dispenser drawer were closed after washing.</p> <ul style="list-style-type: none">■ Leave the door and the detergent dispenser drawer slightly open to allow them to dry.
The washer shakes during the spin cycle.	<p>The four feet are not resting evenly on the floor.</p> <ul style="list-style-type: none">■ Level the machine (see “Leveling the washer”).
The laundry has not been spun properly and the laundry is still wet.	<p>The machine detected an imbalance during the final spin and reduced the spin speed automatically.</p> <ul style="list-style-type: none">■ Wash large and small items together in order to achieve a more even load distribution.
There are unusual sounds coming from the drain pump.	<p>There is no fault!</p> <p>Lapping sounds at the beginning and end of the drain process are normal.</p>
The display shows a foreign language.	<p>The display language was adjusted.</p> <ul style="list-style-type: none">■ Select the display language. See “Setting the display language”.

Frequently Asked Questions

General problems with the washing machine

Problem	Possible cause and solution
<p>Large amounts of detergent residue remain in the detergent dispenser drawer.</p>	<p>The water pressure is too low.</p> <ul style="list-style-type: none"> ■ Clean the filter in the water intake.
	<p>Powder detergent used in conjunction with water softeners tends to become sticky.</p> <ul style="list-style-type: none"> ■ Clean the detergent dispenser drawer and in future, add detergent first and then the water softener.
<p>The fabric softener is not completely dispensed or too much water remains in the compartment. </p>	<p>The siphon tube is either positioned incorrectly or clogged.</p> <ul style="list-style-type: none"> ■ Clean the siphon tube, see “Cleaning and care - Cleaning the detergent drawer”.
<p>At the end of the program there is still liquid in the capsule.</p>	<p>The small pipe in the detergent dispenser drawer onto which the capsule is placed is blocked.</p> <ul style="list-style-type: none"> ■ Clean the small pipe.
	<p>Not a fault. For technical reasons, a small amount of water will remain in the capsule.</p>
<p>There is water next to the capsule in the fabric softener compartment.</p>	<p>The  sensor button was not activated.</p> <ul style="list-style-type: none"> ■ Activate the  sensor button when a capsule is next used.
	<p>An empty capsule was not removed at the end of the last wash program.</p> <ul style="list-style-type: none"> ■ Remove and then dispose of the empty capsule at the end of each wash cycle.
	<p>The small pipe in the detergent dispenser drawer onto which the capsule is placed is blocked.</p> <ul style="list-style-type: none"> ■ Clean the small pipe.



Frequently Asked Questions

Poor wash results

Problem	Possible cause and solution
Liquid detergent is not achieving the required results.	<p>Liquid detergents do not usually contain bleaching agents. Consequently, fruit, coffee, and tea stains cannot always be removed.</p> <ul style="list-style-type: none">■ Use the Miele 2-phase system. The deliberate addition of UltraPhase 2 during the wash process removes stains effectively.■ Use powder detergent containing a bleaching agent.
Gray, greasy particles cling to washed laundry.	<p>Insufficient amounts of detergent were used. The laundry was heavily soiled with grease (oils, ointments).</p> <ul style="list-style-type: none">■ Use more detergent or liquid detergent with this type of soiled laundry.■ Before washing the next load, run the <i>Clean Machine</i> wash program using a universal powder detergent.
White residues which look like powder detergent are seen on dark textiles after washing.	<p>The detergent contained compounds (zeolites) to aid water softening which are not soluble in water. These have ended up on the laundry.</p> <ul style="list-style-type: none">■ Try and brush off the residues with a soft brush once the laundry is dry.■ In the future, wash dark textiles using a detergent which contains no zeolites. Liquid detergents do not usually contain zeolites.■ Use the <i>Darks/Denim</i> program to wash the textiles.

Frequently Asked Questions

The drum door cannot be opened

Problem	Possible cause and solution
The door cannot be pulled open during a program.	The drum is locked during a program. ■ Follow the description in “6. Starting a program – Adding or removing laundry”.
Comfort Cooling appears in the display after a program has been canceled.	To protect the user against scalding, the door cannot be opened if the suds temperature is higher than 130°F (55°C). ■ Wait until the temperature in the drum has decreased and the message has gone out in the display.
The following appears in the display:   Service Door release fault F35	The door lock has jammed. ■ Contact Customer Service.

Frequently Asked Questions

Opening the door in the event of a blocked drain outlet and/ or power outage

- Turn off the washing machine.



- Open the drain pump flap.

Blocked drain outlet

If the drain outlet is blocked, a larger quantity of water can remain in the washing machine.

⚠ Risk of scalding due to hot suds. Escaping suds will be hot if laundry has been washed at high temperatures. Carefully allow all suds to drain off.

Draining the washing machine

Remove the drain filter, though not completely.

- Place a suitable container under the flap, e.g., a bowl or dish.

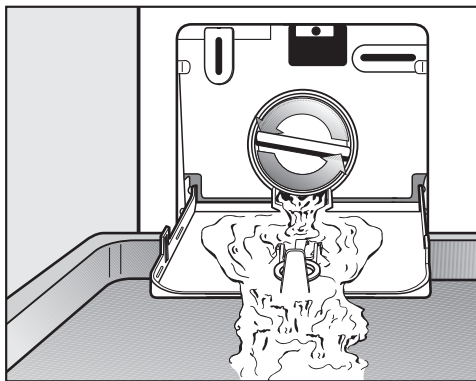

- Slowly unscrew the drain filter to let the water out.
- Tighten the drain filter back up again if you need to interrupt the flow of water.

Once the flow of water stops:

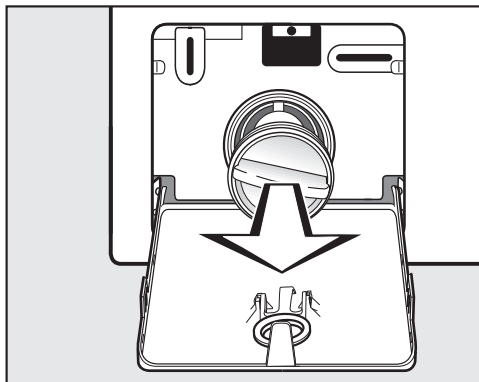

- Remove the drain filter completely.

Frequently Asked Questions

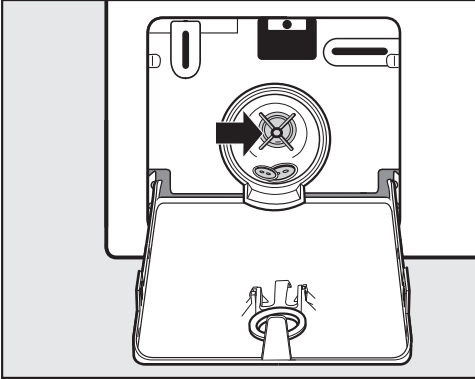

- Clean the drain filter thoroughly.
- Remove any foreign objects (e.g., buttons, coins, etc.) and clean the interior. Turn the impellers by hand to check that they rotate freely.
- Replace the drain filter correctly and tighten it securely.
- Close the drain pump flap.



Risk of water damage

Make sure the drain filter is securely tightened. Otherwise there is a risk of water leakage during use.

Replace the drain filter correctly and tighten it securely.

Opening the door



Danger of injury due to rotating drum.

Reaching into a rotating drum is extremely dangerous and may result in injury.

Always make sure that the drum is stationary before reaching in to remove laundry.

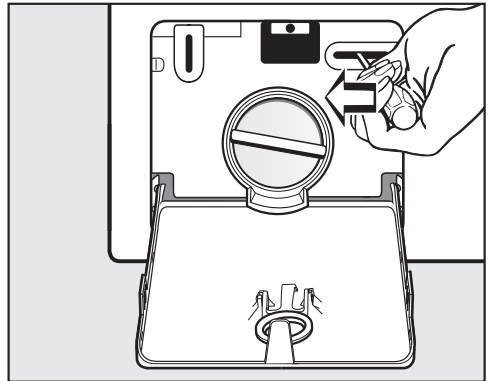

- Use a screwdriver to unlock the door.
- Pull open the door.

Customer Service

Contact in the event of a fault

In the event of a fault which you cannot remedy yourself, please contact your Miele dealer or Miele Customer Service.

You can book a Miele Service Call online at www.miele.com/service.

Contact information for Miele Customer Service can be found at the end of this document.

Please quote the model identifier and serial number of your appliance (SN) when contacting Miele Customer Service. Both pieces of information can be found on the data plate.

The data plate is found above the porthole glass when the door is opened.

Optional accessories

Optional accessories are available through your Miele dealer or Miele.

Appliance warranty and product registration

You can register your product and/or view the manufacturer's warranty terms and conditions for Miele appliances and vacuum cleaners at www.mieleusa.com.

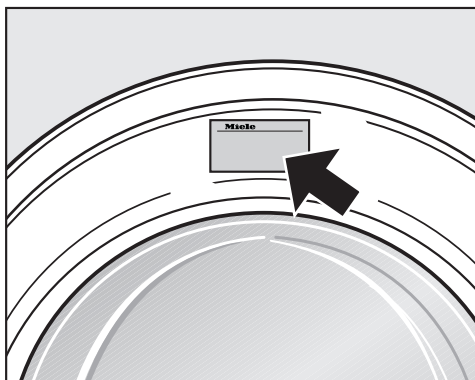

Front view

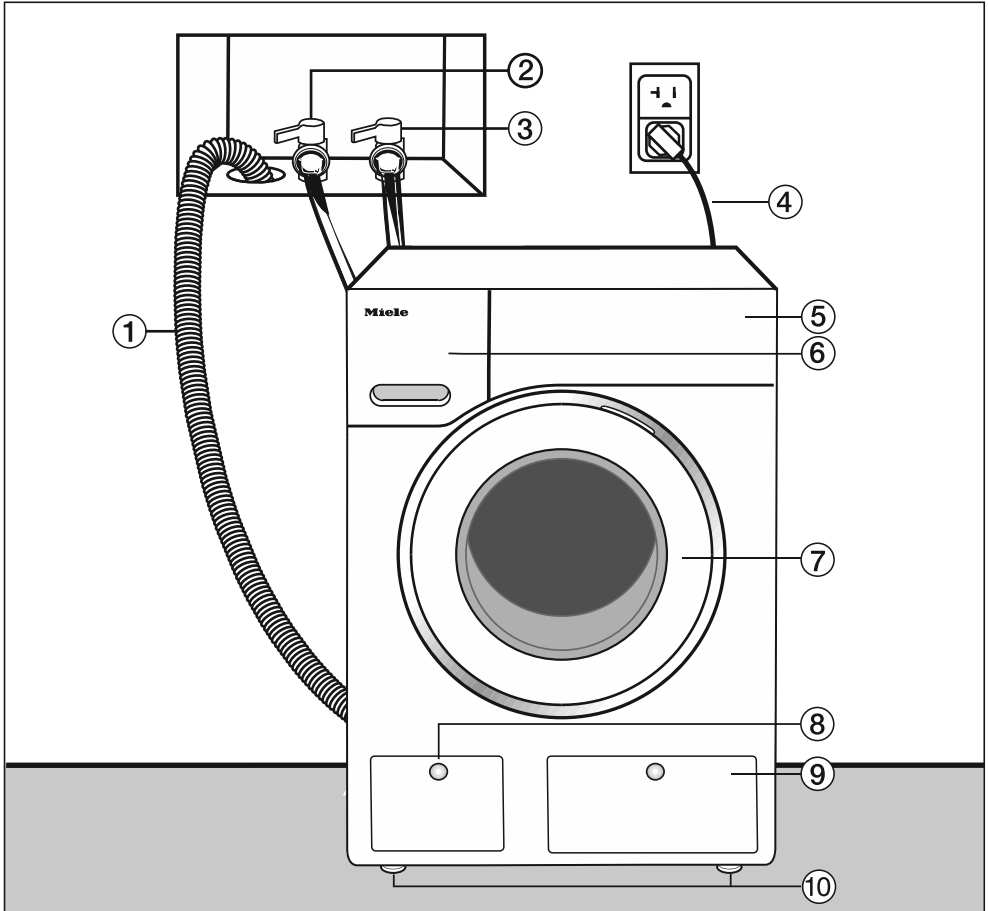

- ① Drain hose
- ② Hot-water inlet hose (pressure-proof to 870 psi/6,000 kPa)
- ③ Cold-water inlet hose (pressure-proof to 870 psi/6,000 kPa)
- ④ Electrical connection
- ⑤ Control panel
- ⑥ Detergent dispenser drawer
- ⑦ Door
- ⑧ Flap for drain filters, drain pump, and emergency release
- ⑨ Flap for TwinDos cartridges
- ⑩ Four height-adjustable feet

Installation

Rear view

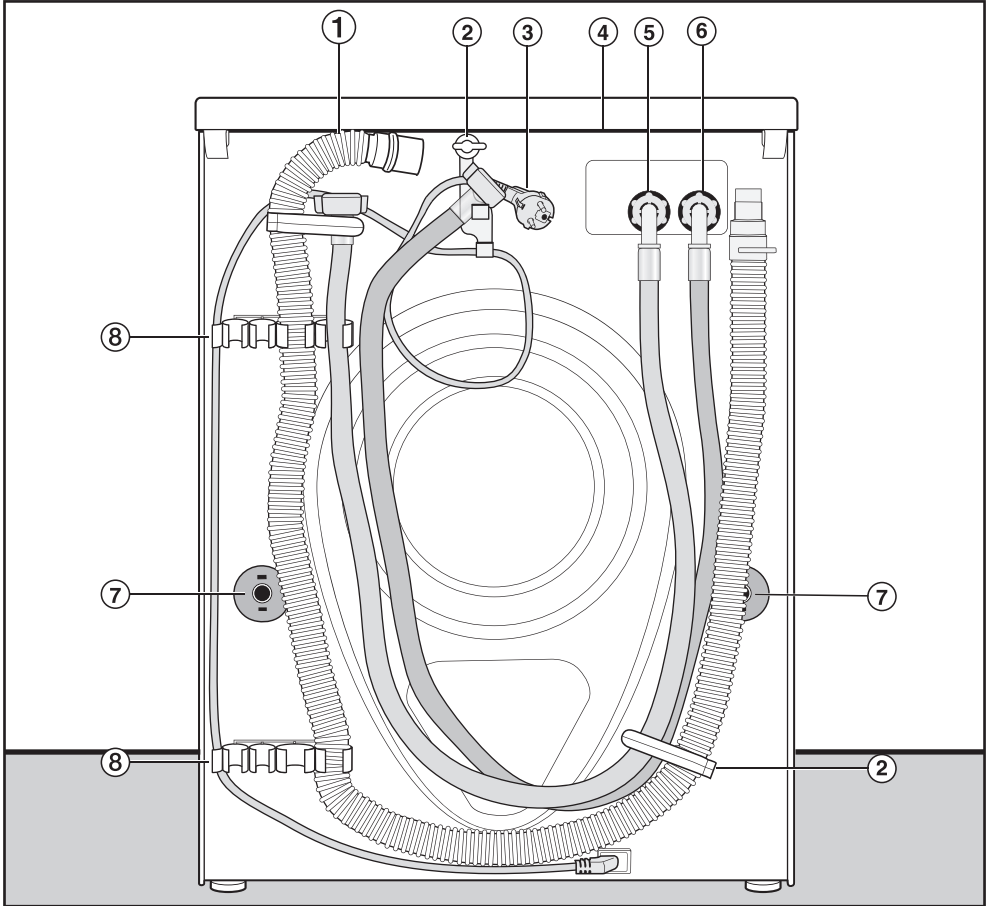

- ① Drain hose
- ② Transport clips for inlet and drain hoses and power cord
- ③ Electrical connection
- ④ Protruding lid for holding when moving the machine
- ⑤ Cold-water inlet hose (pressure-proof to 870 psi/6,000 kPa)
- ⑥ Hot-water inlet hose (pressure-proof to 870 psi/6,000 kPa)
- ⑦ Safety caps for shipping struts
- ⑧ Transport clips for inlet and drain hoses and for storing shipping struts when not in use

Installation surface

A concrete floor is the most suitable installation surface for this machine. It is far less prone to vibration during the spin cycle than wooden floorboards or a carpeted surface.

Please note:

- The machine must be level and securely positioned.
- To avoid vibrations during spinning, the machine should not be installed on soft floor coverings.

If installing on a wooden joist floor:

- Install the unit on a 2 ft. x 2 ft. x 1 $\frac{3}{16}$ " (61 x 61 x 3 cm) plywood base. Ideally the base should be large enough to span several joists and should be anchored to the joists and not just the floor boards.

Tip: If possible, install the machine in a corner. This is usually the most stable part of the floor.

 Injury can occur if the washing machine has not been adequately secured.

During installation, the washing machine must be secured on a raised plinth to be made available on site (concrete or brick), in order to ensure it cannot fall or slip.

Secure the washing machine using a clamp/fastening bracket (MTS floor mounting kit – available from your Miele dealer or Miele Service).

Transporting the washing machine to its installation site

 Danger of injury due to unsecure lid.

The fixings at the back of the lid may become brittle due to external circumstances. There is a danger of the lid being pulled off when carrying the appliance.

Before carrying the appliance, check that the lid is secure where it protrudes at the back of the appliance.

- Carry the washing machine by the front feet and by the lid where it protrudes at the back of the appliance.

Installation

Removing the shipping struts

Removing the left-hand shipping strut

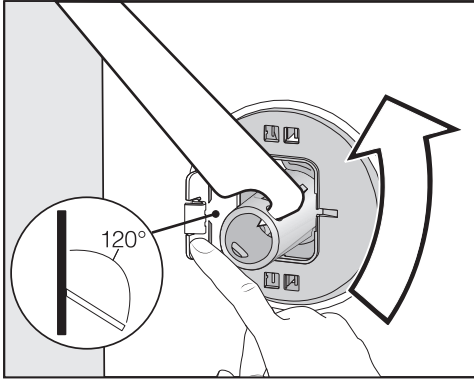

- Open the cover and use the wrench supplied with the washing machine to turn the shipping strut 90°.

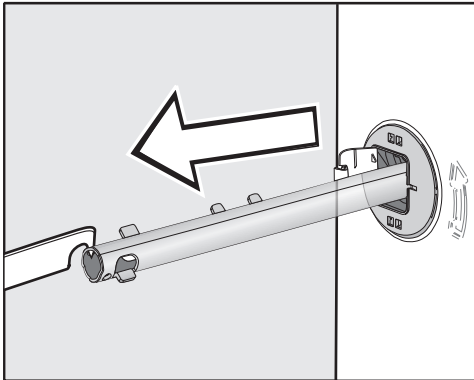

- Pull out the shipping strut.

Removing the right-hand shipping strut

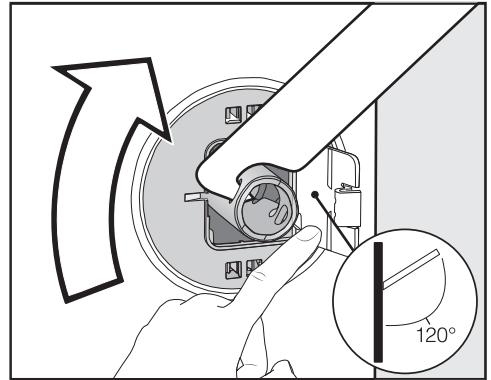

- Open the cover and use the wrench supplied with the washing machine to turn the shipping strut 90°.

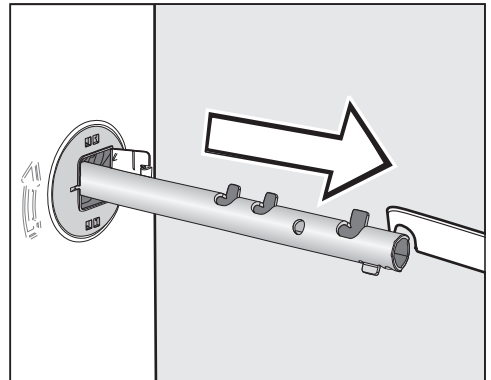

- Pull out the shipping strut.

Covering the holes

 Risk of injury from sharp edges. There is a risk of injury from reaching into holes that are not covered. Cover the holes for the shipping struts after they have been removed.

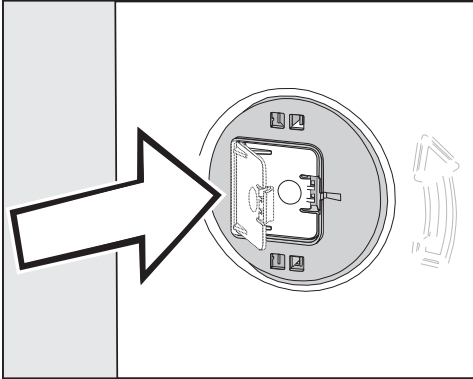

- Press the covers firmly shut until they click into place.

Securing the shipping struts

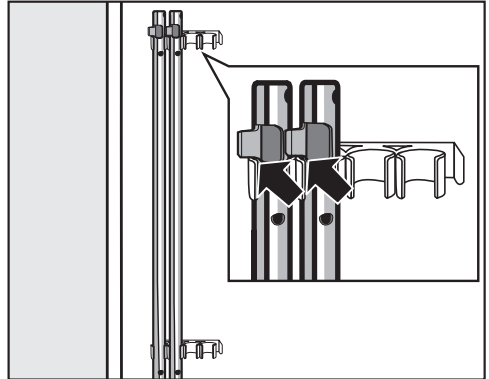

- Secure the shipping struts to the back of the washing machine. Make sure that the top catch is located above the holder.

 Risk of damage from incorrect transport.

The washing machine may become damaged if moved without the shipping struts in place.

Keep the struts in a safe place. Install them again if the washing machine is to be moved (e.g., when moving to a new house).

Installation

Installing the shipping struts

Opening the covers

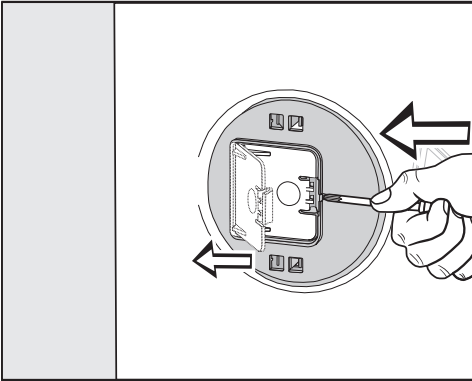

- Press against the catch with a thin object (a narrow screwdriver, for example).

The cover opens.

Installing the shipping struts

- Install the shipping struts by following the instructions for their removal in reverse order.

Tip: The struts will slide in more easily if you lift the drum slightly.

Leveling the machine

The washing machine must stand perfectly level on all four feet to ensure safe and proper operation.

Incorrect installation may increase electric and water consumption and may cause the machine to move about.

Unscrewing and adjusting the feet

The four adjustable screw feet are used to level the washing machine. All four feet are screwed in when the machine is delivered.

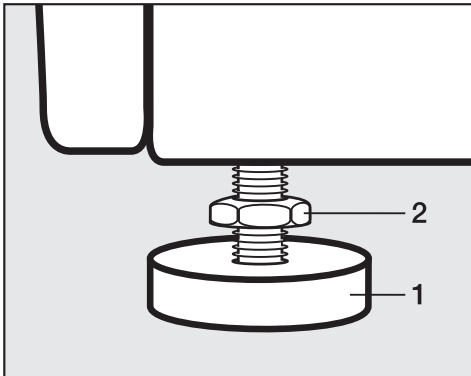

- Using the wrench supplied, turn counter nut **2** in a clockwise direction. Then turn counter nut **2** together with foot **1** to unscrew.



- Use a spirit level to check that the washing machine is standing level.
- Hold foot **1** securely with a pipe wrench. Turn counter nut **2** again using the wrench supplied until it sits firmly up against the housing.

 Risk of damage due to incorrectly aligned washing machine.

There is a danger of the washing machine moving about if the feet are not secured.

Turn all four counter nuts for the feet until they sit firmly up against the housing. Please also check this for the feet which did not need adjustment.

Installation

Installing under a countertop

 Risk of electric shock due to exposed cables

There is a risk of coming into contact with live parts while the lid is removed.

Do not remove the washing machine lid.

This washing machine (with lid intact) can be pushed under a countertop if there is space to do so.

Washer-dryer stack

The washing machine can be installed as a washer-dryer stack together with a Miele Tumble Dryer. A WTV stacking kit* is required for this.

Parts marked with * are available from your Miele dealer or Miele Customer Service.

Please note:

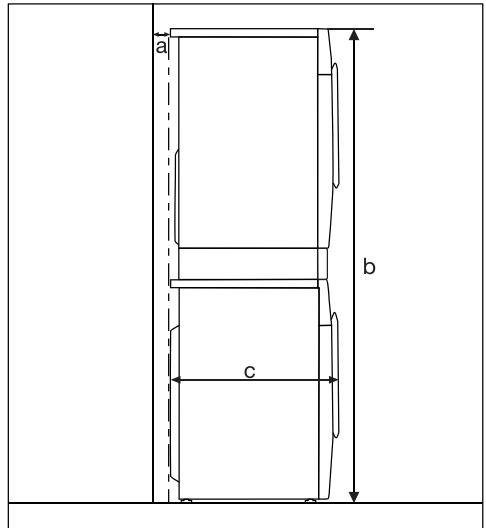

a = at least $\frac{3}{4}$ " (2 cm)

b = WTV without drawer: $67 \frac{11}{16}$ "
(172 cm)

WTV with drawer: $71 \frac{1}{4}$ " (181 cm)

c = $25 \frac{9}{16}$ " (65 cm)

Additional installation requirements

The washing machine must be installed in accordance with the relevant local regulations.

⚠ Damage resulting from failure to remove the shipping struts. Failure to remove the shipping struts can result in damage to the washing machine and to adjacent cabinetry or appliances. Remove the shipping struts as described in “Installation and connection”.

Installing under a countertop

⚠ Risk of electric shock due to exposed cables. There is a risk of coming into contact with live parts while the lid is removed. Do not remove the washing machine lid.

This washing machine (with lid intact) can be pushed under a countertop if there is space to do so.

Setting up the cabinet

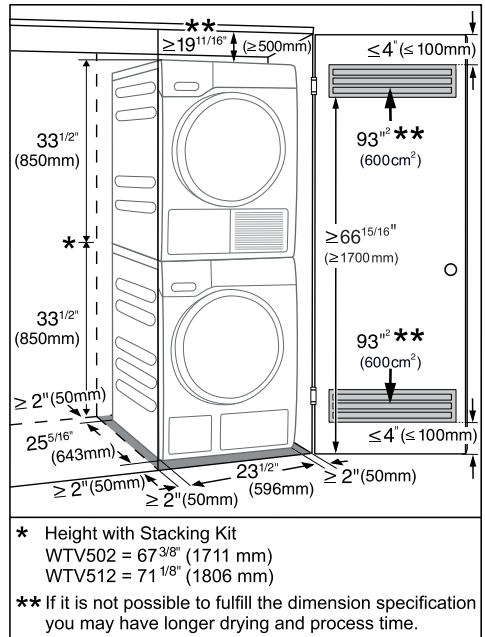

Installation

For closets at room height

You can also insert a ventilation opening at the top of the closet. In addition, you must provide an opening on the bottom side of the door.

⚠ Risk of damage due to overheating of the washing machine. The air supply must not be hindered by an additional closet or shelf. Please ensure that air is able to circulate freely at the top of the closet.

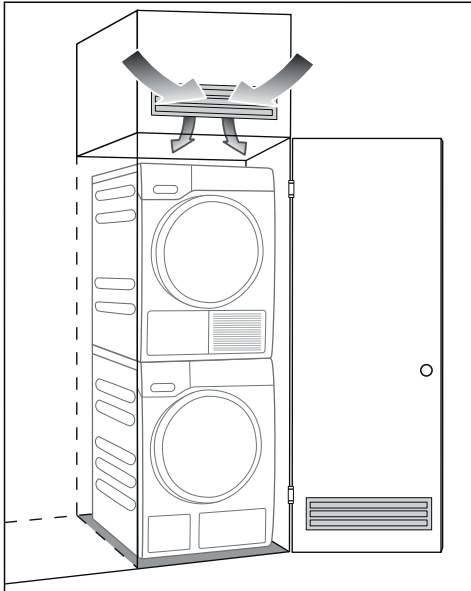

Product Dimensions

Dimensions

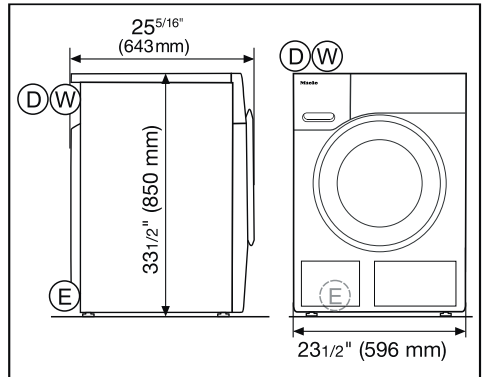

- ⓓ = 4.9 ft (1.50 m) drain hose with connection to the top left on the rear
- ⓔ = 6.5 ft (2.00 m) electrical cord with plug for 120 V, 15 A (NEMA 5-15 configuration) to the top left on the rear
- Ⓦ = 5.2 ft (1.60 m) warm and cold-water intake hoses to the top left on the rear

Installation on a plinth

- WTS 510 (only available in white)

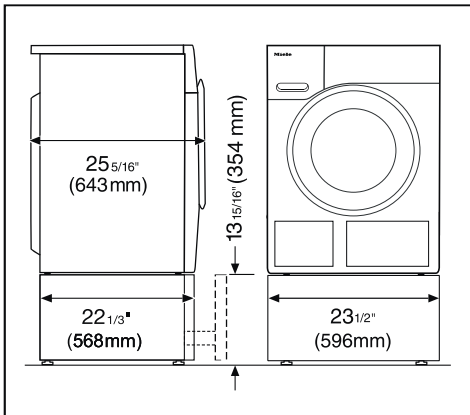

Washer-dryer stack

- WTV 512 and WTV 502 washer-dryer stacking kit

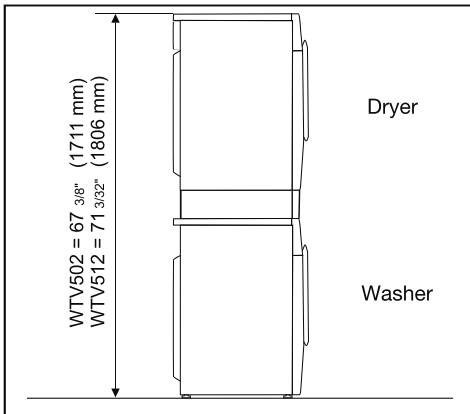

Installation

The water protection system

The Miele water protection system protects all parts of the washing machine and its surroundings from water damage.

The system consists of the following main components:

- the inlet hose
- the electronic module and drainage and overflow protection
- the drain hose

Inlet hoses

- Protection against the hoses bursting

The inlet hose can withstand pressure of more than 1,015 psi (7,000 kPa).

Electronic module and washing machine housing

- Sump: Any leaking water is collected in a sump in the base of the machine. A float switches off the water inlet valves, preventing any more water from flowing into the machine and water in the suds container is pumped away.
- Overflow protection: This prevents the washing machine taking in too much water. If the water level exceeds a certain level, the drain pump switches on and pumps the excess water away in a controlled way.

Water intake

 Health risk and risk of damage due to contaminated incoming water. The quality of the incoming water must comply with the requirements for drinking water in the country in which the washing machine is being operated. Always connect the washing machine to the drinking water supply.

The washing machine can be connected to a portable water supply. A non-return valve is not needed unless required by building code.

The washing machine has ½" (13 mm) pressure hoses with ¾" (19 mm) female hose thread connections. If there is no water hookup, contact a plumber to install a connection. Make sure that the sealing ring is seated properly on the hose connector.

Replace the hose only with a genuine Miele hose, or with a hose able to withstand up to 145 psi (1,000 kPa) pressure. The water valve connector must also be able to withstand 145 psi (1,000 kPa).

The bolted connection is under water pressure. Open the water supply slowly to check for leaks. Adjust the rubber seal and the bolted connection if necessary.

Maintenance

Only use a genuine Miele hose that has been tested to withstand pressure of at least 870 psi (6,000 kPa) should you ever need a replacement.

 A filter is located in the open end of the inlet hose and another in the intake point to protect the inlet valve. Neither filter may be removed.

Installation

Water drainage

The suds are drained through a drain pump with a 3.2 ft (1 m) delivery head.

For the water to drain freely, the hose must be installed free of kinks.

If required, the hose can be extended to a length of up to 16.4 ft (5 m).

Accessories are available from your Miele dealer or the Miele Technical Service.

Drainage options:

1. Direct into a sink or basin:

Please note:

- Hook the hose over the edge and secure!
- If the water is pumped into a sink, be sure that it can drain away quickly enough. Otherwise there is a risk of water overflowing or of some of the drained water being sucked back into the machine.

2. Connected securely to a plastic drain pipe with a rubber nipple (there is no need to use a non-return valve).

3. Connected securely to a floor drain.

4. Connected securely to a sink with a plastic nipple.

Installing the elbow

Use the elbow supplied to stop the drain hose from slipping.

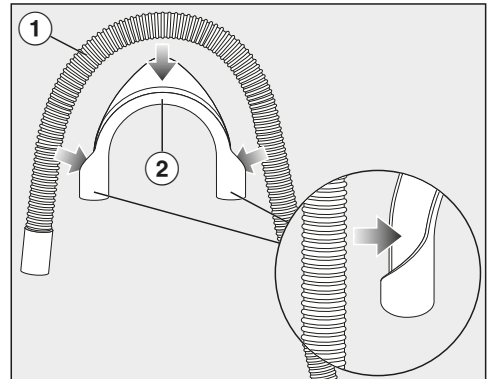

- Attach the elbow ② to the drain hose ①.

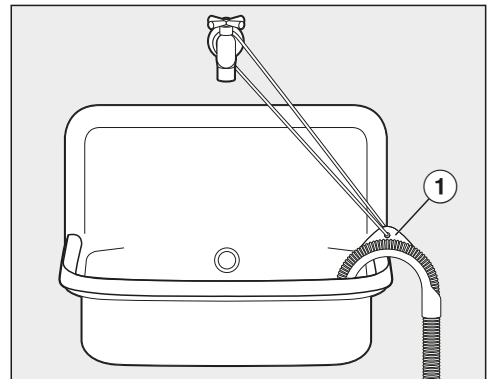

- Place the end of the drain hose in a sink.
- Use a strap with eyelet ① to stop the elbow from slipping.

Electrical connection

GROUNDING INSTRUCTIONS

This appliance must be grounded. In the event of a malfunction or breakdown, grounding will reduce the risk of electric shock by providing a path of least resistance for electric current. This appliance is equipped with a cord having an equipment-grounding conductor and a grounding plug. The plug must be plugged into an appropriate outlet that is properly installed and grounded in accordance with all local codes and ordinances.

WARNING – Improper connection of the equipment-grounding conductor can result in a risk of electric shock. Check with a qualified electrician or service representative if you are in doubt as to whether the appliance is properly grounded.

Do not modify the plug provided with the appliance; if it will not fit the outlet, have a proper outlet installed by a qualified electrician.

ELECTRICAL INSTRUCTIONS

This installation should be performed by an experienced and qualified technician, in accordance with local codes and regulations.

The washing machine is supplied with a 5' 3" (1.6 m) long, 3 wire cord, ending in a NEMA 5-15P plug, ready for connection to a 120 V, 15 A, 60 Hz, AC power supply.

The manufacturer recommends operating the appliance on a dedicated circuit to avoid overloading the electrical circuit.

The proper outlet can be purchased from an electrical supply dealer.

Technical data

Height	33 7/16" (850 mm)
Width	23 7/16" (596 mm)
Depth	25 1/16" (636 mm)
Depth with door open	41 1/2" (1054 mm)
Height for building under	32 5/16" (+5/16"/-1/16") (820 mm)
Width for building under	23 5/8" (600 mm)
Weight	Approx. 220.5 lb (100 kg)
Capacity	17,6 lb/8 kg dry laundry
Connection voltage	See data tag
Rated load	See data tag
Fuse rating	See data tag
Minimum water flow pressure	14.5 psi (100 kPa)
Maximum water flow pressure	145 psi (1,000 kPa)
Water-inlet hose length	5.3 ft. (1.6 m)
Drain-hose length	5 ft. (1.5 m)
Power-cord length	6.6 ft. (2 m)
Maximum drain height	3.3 ft (1 m)
Maximum drain length	16.4 ft (5 m)
LEDs	Class 1
Test certificates awarded	See data tag
Frequency range	2.412–2.462 GHz
Maximum transmission power	< 100 mW

You can use the settings to alter the washing machine's electronics to suit changing requirements.

The settings can be altered at any time.

Calling up settings

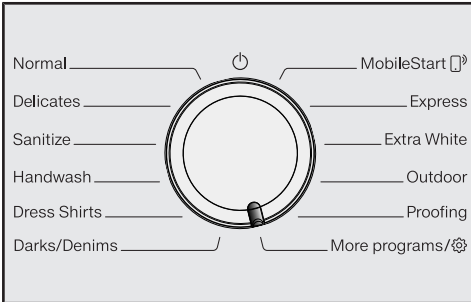

- Turn the program selector to the *Additional programs/⚙️* position.



- Touch the ∇/Δ sensor buttons until the following appears in the display:



- Confirm with the *OK* sensor button.



You are now in the *Settings* submenu.

Selecting settings

- Touch the ∇/Δ sensor buttons until the setting you want appears in the display.
 - The ∇ sensor button scrolls down the list.
 - The Δ sensor button scrolls up the list.
- Touch the *OK* sensor button to select the setting displayed.

Changing a setting

- Touching the ∇/Δ sensor buttons will call up the different options for the setting.

The option which is selected will have a check \checkmark next to it.

- Touch the *OK* sensor button to activate the option you want in the display.

Closing the Settings menu

- Turn the program selector.

Settings

Language

The display can be set to appear in one of several different languages.

The  flag after the word Language acts as a guide in case a language which is not understood has been set.

The language selected is saved to memory.

TwinDos

You can set the type of detergent and dispensing quantities and check the fill level of the UltraPhase 1 and UltraPhase 2 cartridges.

Change dosage

The set values for dispensing UltraPhase 1 and UltraPhase 2 detergent can be checked and corrected.

Check level

The level is displayed with a bar chart.

The display only works correctly when the following conditions are met:

1. New (full) cartridges are used.
2. The cartridges must not be removed from the washing machine in the interim period.

Tip: The level can be corrected via the Miele@mobile app.

Select detergent

You can either use UltraPhase 1 and UltraPhase 2, or switch TwinDos dispensing off.

Use the No agent setting to switch TwinDos dispensing off.

Degree of soiling

You can specify the degree of soiling that is pre-set for the  sensor button.



Options:

- Light
- Normal (factory default)
- Heavy

Buzzer volume

The buzzer can be set to be louder or quieter.

Options

-  (quiet)
-  (loud) (factory default)

Keypad tone

Each touch of a sensor button is confirmed with an audible tone.

Options

- Off
- ■■■■■■■■ (quiet)
- ■■■■■■■■ (factory default)
- ■■■■■■■■ (loud)

Welcome tone

The volume for the welcome tone can be set to one of 7 different settings.

Options

- Off
- ■■■■■■■■ (quiet)
- ■■■■■■■■ (factory default)
- ■■■■■■■■ (loud)

Code

The PIN code prevents the washing machine being used without your knowledge.

Options

- Activate
When the PIN code has been activated, you have to enter it after switching the washing machine on. Otherwise, the washing machine cannot be operated.
The factory default PIN code is 125.
- Change
However, you can set a different, three-digit PIN code.

 Make a note of the new PIN code. If you forget the code, the washing machine will need to be unlocked by Miele Service.

- Deactivate
The washing machine is to be operated again without entering the PIN code. This only appears if the PIN code has been activated previously.

Settings

Unit

The temperature and spin speed values can be displayed in different ways.







Options

- Clear text (factory default)
The values are displayed as words.
- $^{\circ}\text{C} + \text{rpm}$
The temperatures are displayed as figures in $^{\circ}\text{C}$.
- $^{\circ}\text{F} + \text{rpm}$
The temperatures are displayed as figures in $^{\circ}\text{F}$.

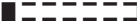
Brightness

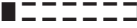
You can set the brightness of the display, the sensor buttons, and the dimmed sensor buttons.

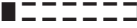
Options

- Display
Controls the brightness of the display.
 -  (dark)
 -  (light) (default setting)
- Buttons active
Controls the brightness of the activated sensor buttons.
 -  (dark)
 -  (factory default)
 -  (light)
- Buttons inactive
Controls the brightness of the sensor buttons that can be activated.
 -  (dark)
 -  (factory default)
 -  (light)

Tip: Ensure that there is a big difference in brightness between the activated and dimmed sensor buttons. A big difference in brightness makes it easier to operate the appliance.

Display switch-off

The display and the sensor button lighting is switched off to save energy. The Start/Add laundry sensor button flashes slowly.

Options

- On(factory default)
The lighting switches off after 10 minutes.
- On (not crnt prog)
The lighting remains switched on throughout the program. The lighting switches off 10 minutes after the program has ended.
- Off
The lighting remains switched on.

Program info

You can select the information that will be displayed temporarily once a program has been selected in the display.

Options

- Program name (factory default)
The program name is shown in the display for several seconds.
- Prog. & Max load
The program name and the maximum load are shown in the display for several seconds.
- Off
Directly after the program has been selected, the standard display is shown with temperature, spin speed, and program duration.

Memory

The washing machine will save the last settings (temperature, spin speed, and some of the extra options) selected for a wash program after the program has started.

When the program is chosen again, the saved settings will appear on the display.

Memory is deactivated as standard.

Water intake

You can program 2 options for the water inlet. The water inlet is controlled by the two inlet hoses.

Options

- Cold water
The washing machine will be operated with cold water only.
- Hot water  (default setting)
Hot water is used in the main wash to save energy.
You can heat up your water with cheaper, primary energy sources, e.g., gas, solar power, oil. The temperature must be below 140°F (60°C.)

 For technical reasons, the washing machine **must** always be connected to cold water.

Settings

Soak duration

You can set a duration for the soak process of between 30 minutes and 6 hours.

A duration can be selected in 30-minute increments. When the *Soak extra* option is selected, the laundry will be soaked for the duration selected.

A duration of 0:30 h is set as standard.

Gentle action

When Gentle action is activated, drum rotation is reduced. In this way, lightly soiled items can be washed more gently.

Gentle action can be activated for the *Normal* and *Wrinkle-free* programs.

Gentle action is deactivated as standard.

Temp. reduction

At high altitudes, water has a lower boiling point. Miele recommends switching on the reduced-temperature setting at altitudes of 6,560 ft (2,000 m) or above to prevent water from boiling. The maximum temperature is reduced to 176°F (80°C), even if a higher temperature has been selected.

The reduced-temperature setting is deactivated as standard.

Maximum rinse level

This function is important for allergy sufferers as it achieves excellent wash results.

The water level in the rinses can be permanently set to the highest value. The water consumption will be increased.

The maximum rinse level is deactivated as standard.

Suds cooling

Additional water flows into the drum at the end of the main wash to cool the suds down.

Suds cooling takes place when a *Normal* program with a temperature of 158°F (70°C) or higher is selected.

Suds cooling must be activated:

- to prevent the danger of scalding if the drain hose is hooked over the edge of a sink or basin
- where the drainage pipes do not comply with DIN 1986

Suds cooling is deactivated as standard.

Low water pressure

If the water pressure is below 14.5 psi (1 bar), the program will be canceled and the fault message *Water intake* See  will appear.

If the on-site water pressure cannot be increased, activating this function will prevent the program from being canceled.

Low water pressure is deactivated as standard.

Anti-Crease

The Anti-crease function helps prevent creasing after the end of the program.

At the end of the program, the drum continues to turn for up to 30 minutes. The washing-machine door can be unlocked at any time by touching the *Start/Add laundry* sensor button and then opened.

Anti-crease is activated as standard.

Miele@home

Control the networking of your washing machine with your WiFi network.

The following points may appear in the submenu:

Set up

This message only appears if the washing machine has not yet been connected to a WiFi network.

Please refer to “Before using for the first time” for instructions on how to set up the connection.

Deactivate (visible if Miele@home is activated)

Miele@home remains set up; the WiFi function is turned off.

Activate (visible if Miele@home is deactivated)

The WiFi function is reactivated.

Connection status (visible if Miele@home is activated)

The following values are displayed:

- the quality of WiFi reception
- the network name
- the IP address

Set up again (visible if set up)

Resets the WiFi login (network) to immediately re-establish a new connection.

Reset (visible if set up)

- The WiFi is switched off.
- The WiFi connection will be reset to the factory default.

The network configuration should be reset whenever a washing machine is being disposed of or sold, or if a used washing machine is being put into operation. This is the only way to ensure that all personal data has been removed and the previous owner will no longer be able to access the washing machine.

A new connection setup has to be carried out in order to use the Miele@home setting again.

Settings

Remote control

The Remote control setting is only visible if the Miele@home setting is set up and activated.

Once the Miele app has been installed on your mobile device, you can check the status of your washing machine from anywhere and start it remotely. You can also control it remotely via the *MobileStart* program.

You can switch off the Remote control setting if you do not want to operate the washing machine with your mobile device.

If Remote control is not switched on, the app can cause the program to be canceled.

Use the Delay Start button to set a time until you want to start the washing machine and start the Delay Start function (see “Delay Start/SmartStart”). The washing machine will then start within the timeframe specified when it receives your signal.

If it has not received a start signal by the latest start time set, the washing machine will start automatically.

Remote control is activated as standard.

SmartGrid

The SmartGrid setting is only visible if the Miele@home setting is set up and activated.

You can set your washing machine to start automatically based on an external signal within a certain time period.

Activating SmartGrid gives the *Delay Start* sensor button a new function. You set the SmartGrid via the Delay Start button. The washing machine will then start within the time period specified by you when it receives an external signal. If an external signal has not been received by the latest start time set, the washing machine will start automatically (see “Delay Start”).

SmartGrid is deactivated as standard.

RemoteUpdate

The RemoteUpdate menu option is only displayed and can only be selected if the requirements for using Miele@home have been met (see “Before using for the first time – Miele@home”).

The RemoteUpdate function updates the software in your washing machine. If an update is available for your washing machine, it will automatically download it. Updates will not be installed automatically. They must be initiated manually.

If you do not install an update, you can continue to use your washing machine in the usual way. However, Miele recommends installing updates.

Activating/deactivating

The RemoteUpdate function is activated as standard. Available updates will be downloaded automatically but will only be installed if you initiate installation manually.

Deactivate RemoteUpdate if you do not want any updates to be downloaded automatically.

Running a RemoteUpdate

Information about the content and scope of an update is provided in the Miele app.

A message will appear in your washing-machine display if a software update is available.

You can install the update immediately or postpone this until later. When the washing machine is switched on again, you will be reminded about the update.

Deactivate RemoteUpdate if you do not want to install the update.

The update may take several minutes.

Please note the following information about the RemoteUpdate function:

- You will only receive a message when an update is available.
- Once an update has been installed, it cannot be undone.
- Do not switch off the washing machine during an update. Otherwise, the update will be aborted and will not be installed.
- Some software updates can only be carried out by Miele Customer Service.

Settings

Bleach

You can activate the automatic addition of bleach at the end of the main wash.

Bleach may only be used in some programs. See “5. Adding detergent – Using bleach” for more detailed information.

Activating bleach extends the program duration by approximately 10 minutes.

The washing machine is delivered with the bleach setting deactivated.

Copyrights and licenses for the communication module

For the purpose of operating and controlling the communication module, Miele uses proprietary or third-party software that is not covered by open source licensing terms. This software/ these software components are protected by copyright. The copyrights held by Miele and third parties must be respected.

This communication module contains software components which are distributed under open source license conditions. The open source components contained in the appliance along with the corresponding copyright notices, copies of the licensing terms valid at the time, and any additional information can be accessed locally via <http://<IP address>/Licenses>. The liability and warranty arrangements for the open source licenses displayed in this location only apply in relation to the respective rights holders.

Detergent, fabric care products, additives, and machine care products are available for this washing machine. All the products have been designed for Miele washing machines.

These and many other useful products can be ordered via the Miele online shop, from your Miele dealer, or from Miele directly (see end of this manual for contact details).

Detergent

Miele UltraPhase 1 and 2

- 2-component detergent for colors and whites
- For brilliant colors and spotlessly white laundry
- Excellent stain removal even at low temperatures

Miele UltraPhase 1 and 2 Sensitive

- 2-component detergent for colors and whites
- No fragrances or colorants – particularly kind to the skin
- Eco-friendliness verified by Nordic Swan
- Excellent stain removal even at low temperatures

UltraWhite (powder detergent)

- Radiant white laundry thanks to powerful formula with active oxygen
- Excellent stain removal even at low temperatures

UltraColor (liquid detergent)

- With color-protection formula for brilliant colors
- Excellent stain removal even at low temperatures

WoolCare delicates detergent (liquid detergent)

- For wool, silks, and delicates
- Special care complex based on wheat protein and with color-protection formula

Detergents and care products

Special-purpose detergents

These special-purpose detergents are available as convenient single-use capsules.

Caps Sport

- For synthetic fabrics
- Neutralizes unpleasant odors thanks to odor absorber
- Prevents static charge in clothes
- Retains the shape and breathability of synthetic fabrics

DownCare Caps

- For down-filled items
- Maintains the elasticity and breathability of down
- Lanolin for effective cleaning and gentle care
- Down does not clump and remains fluffy

WoolCare Caps

- Wool and delicates detergent
- Special wheat-protein-based agents
- Fiber-protection technology to prevent felting
- Color-protection formula for gentle cleaning

CottonRepair Capsules

- Special-purpose detergent for cotton fabrics
- Visibly renews fabrics with just one wash
- Special Miele formula with Novozymes technology
- Removes pilling and renews color intensity and brightness
- Depending on fabric do not use more than 1–2 times per year

Fabric care

These fabric-care products are available as convenient single-use capsules.

Fabric softener capsules

- Fabric softener for freshly scented laundry
- Pure and thorough cleanliness with a fresh scent
- For soft, bouncy laundry
- Prevents static charge in clothes

Additives

Additives are available as convenient single-use capsules.

Booster capsules

- Highly effective stain remover
- Enzyme technology to help remove stubborn stains
- Suitable for whites and colors
- For best wash results even at low temperatures

Machine care

TwinDosCare

- Cleaning agent for the TwinDos dispensing system
- For use prior to a longer pause in use (at least 2 months)
- For use prior to changing to a different product

Descaling agent

- Removes heavy limescale deposits
- Mild and gentle with natural citric acid
- Gentle on heater elements, drum, and other components

IntenseClean

- For hygienic cleanliness in washing machines
- Removes grease, bacteria, and associated unpleasant odors
- Effective thorough cleaning

Water-softener detergent tabs

- Reduces quantities of detergent for hard water
- Less detergent residue in textiles
- Less chemicals in waste water due to reduced amount of detergent

**Please have the model and serial number
of your appliance available when
contacting Customer Service.**

U.S.A.

Miele, Inc.

National Headquarters

9 Independence Way
Princeton, NJ 08540
www.mieleusa.com

Customer Support

Phone: 888-99-MIELE (64353)
info@mieleusa.com

International Headquarters

Miele & Cie. KG
Carl-Miele-Straße 29
33332 Gütersloh
Germany

Canada

**Importer
Miele Limited**

Headquarters and Miele Centre

161 Four Valley Drive
Vaughan, ON L4K 4V8
www.miele.ca

Customer Care Centre

Phone: 1-800-565-6435
905-532-2272
customercare@miele.ca

WXF 660

en-US

M.-Nr. 11 622 861 / 02