

ASSEMBLY INSTRUCTIONS FOR 67849 (MS244-24-1 M52)

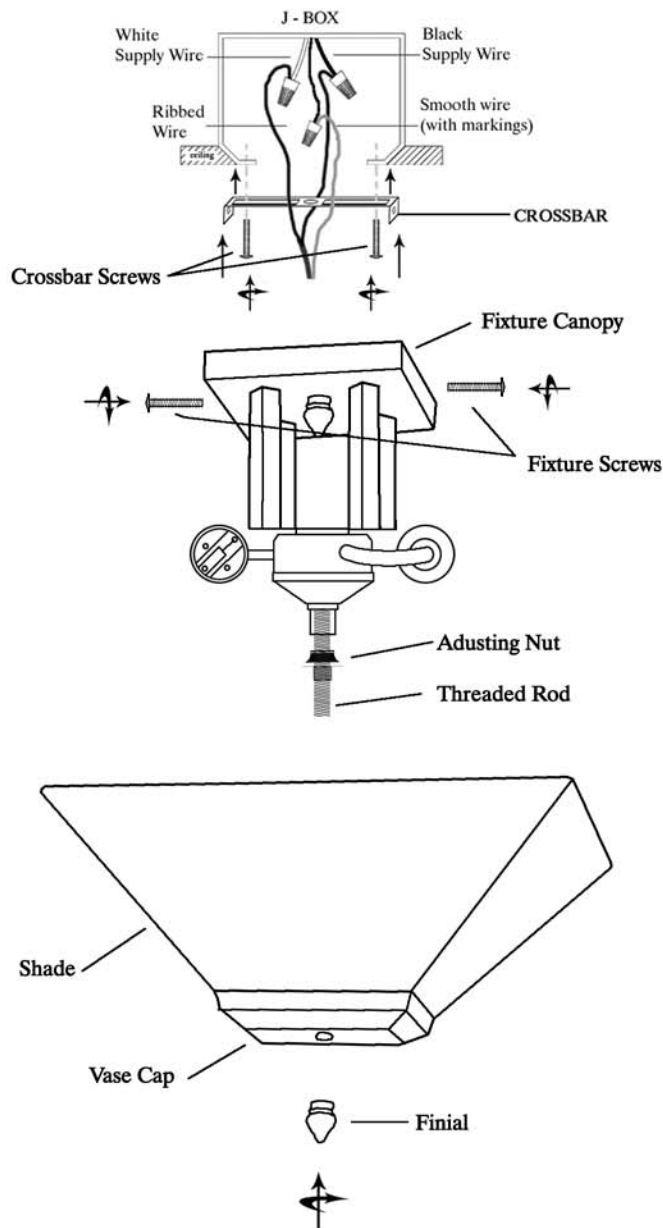

IMPORTANT

TURN OFF THE POWER AT THE MAIN FUSE OR CIRCUIT BREAKER BOX BEFORE STARTING INSTALLATION

CAREFULLY UNPACK AND IDENTIFY ALL PARTS BEFORE ASSEMBLY. BULBS ARE NOT INCLUDED

1. Remove screws from fixture canopy and cross-bar.
2. Screw cross-bar to J-Box using crossbar screws.
3. Attach fixture wires to J-Box wires as shown. (wire as per local electrical code)
4. Place fixture screws through fixture canopy and screw into cross-bar. (Tighten canopy to ceiling.)
5. Place shade up and over fitter socket.
6. Screw finial onto threaded rod and tighten to shade.



"A Commitment to Excellence in Lighting and Service"

CALL OUR CUSTOMER SERVICE DEPARTMENT AT 1-800-222-4009

MONDAY - FRIDAY 8:00 a.m. - 6:00 p.m. ET

visit us on the web at www.meyda.com