

ASSEMBLY INSTRUCTIONS FOR 49148 (MS298-18R-1 HX1D)

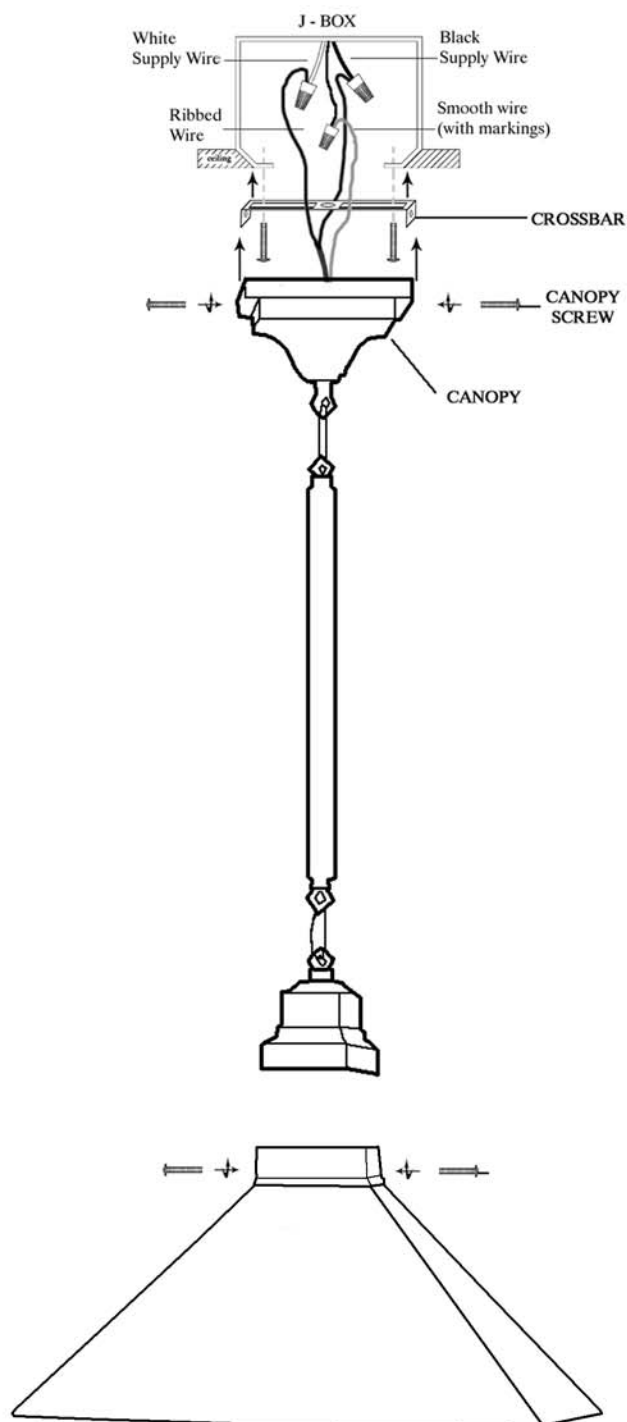

IMPORTANT

TURN OFF THE POWER AT THE MAIN FUSE OR CIRCUIT BREAKER BOX BEFORE STARTING INSTALLATION

CAREFULLY UNPACK AND IDENTIFY ALL PARTS BEFORE ASSEMBLY. BULBS ARE NOT INCLUDED

1. Remove long screws from canopy and cross-bar.
2. Attach fixture wires to J-Box wires as shown. (wire as per local electrical code)
3. Screw cross-bar to J-Box.
4. Place long screws through fixture canopy and screw into cross-bar. (Tighten canopy to ceiling.)
5. Remove uno-ring from fitter socket, loosen (4) set screws from fitter hub.
6. Place shade up and over fitter socket.
7. Screw uno-ring onto fitter socket and tighten to shade.
8. Tighten fitter set screws into shade ring.



"A Commitment to Excellence in Lighting and Service"

CALL OUR CUSTOMER SERVICE DEPARTMENT AT 1-800-222-4009

MONDAY - FRIDAY 8:00 a.m. - 6:00 p.m. ET

visit us on the web at www.meyda.com