

## DESCRIPTION

Cruze LED is a specification lensed troffer series. This high quality luminaire is dedicated to the latest solid state lighting and driver technology for optimal performance and energy efficiency. The Cruze is compatible with all of today's popular ceiling systems and is available with a number of options and accessories for application versatility.

The Cruze series features efficiency, quality and performance. The series is an excellent choice for commercial office spaces, schools, hospitals or retail merchandising areas.

## SPECIFICATION FEATURES

### Construction

Rigid housing is die formed of code gauge prime cold rolled steel and features full length die-formed stiffeners and unibody endplate for added strength. Side flanges are hemmed. Innovative design provides superior lens brightness uniformity and visual comfort. Unibody endplates are securely attached with interlocking tabs and screws. Four auxiliary fixture end suspension points provided. Endplates have integral Grid-lock feature for safety and convenience.

### Controls

The Cruze LED is Powered by Fifth Light, with a standard 0-10V continuous dimming driver that works with any 0-10V control/dimmer. Combine with energy saving products like occupancy sensors, daylighting controls and lighting relay panels to maximize energy savings. In addition, the Cruze can include a factory-installed integrated sensor system for occupancy and daylight dimming control and manual control from an optional handheld remote. Or, specify the Digital Addressable Lighting Interface (DALI) drivers, dimmable down to 10%, for use with Fifth Light

controls. See ordering information for details on all three options.

### Electrical

Long-Life LED system coupled with electrical driver to deliver optimal performance. LED's available in 3000K, 3500K, 4000K or 5000K with a minimum CRI of 80. Projected life is 60,000 hours at 80% lumen output. cULus listed. Electronic drivers are available for 120-277V and 347V applications.

### Emergency Battery Pack Option

Optional 120v-277v integral emergency battery pack is available in 7-watts or 14-watts to meet critical life-safety lighting requirements. The 90-minute batteries provide constant power to the LED system, ensuring code-compliance. A test switch/indicator button can be tested safely from the ground using a laser pointer, while the patented EZ Key prevents accidental discharge of the battery during construction. See ordering information for details.

### Finish

Multistage, iron phosphate pretreatment ensures maximum bonding and rust inhibition. Housing finished with 90%

Catalog #		Type	
Project		Date	
Comments			
Prepared by			

reflective white enamel for superior performance.

### Hinging/Latching

Positive cam action steel latches with baked white enamel finish. Safety-lock T-hinges allow hinging and latching either side. Door assembly hinges down for easy access from below.

### Frame/Sheilding

Die formed, heavy gauge, flat steel door with reinforced mitered corners and painted after fabrication, baked matte white enamel finish. Positive light seals. Acrylic frosted lens.

### Compliance

Modules are UL recognized components and indoor luminaires are cULus listed for 25°C ambient environments, RoHS compliant, and LED modules comply with IESNA LM-79 and LM-80 standards. DesignLights Consortium® Qualified and classified for both DLC Standard and DLC Premium, refer to [www.designlights.org](http://www.designlights.org) for details.

### Warranty

Five year warranty.



**24CZ  
LED**

**2' X 4' TROFFER LED  
MODULE**

Specification Grade Troffer

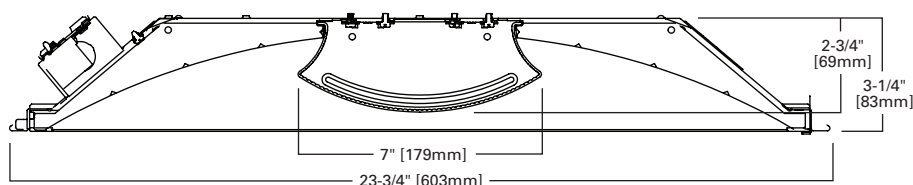

## MOUNTING DATA

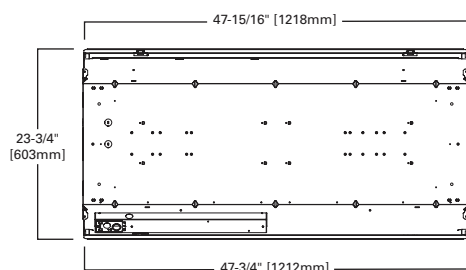

## LAMP CONFIGURATIONS

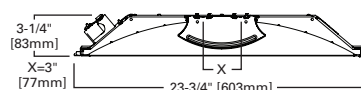

## CEILING COMPATIBILITY

G	G	G	Ceiling Type	Trim Type
Grid/Lay-in Standard	Concealed T	Slot Grid	Exposed Grid	Standard
			Concealed T	Standard
			Slot Grid	Standard
			Flange	*



**LINEAR DISCONNECT**  
Safe and convenient means of disconnecting power

PHOTOMETRICS

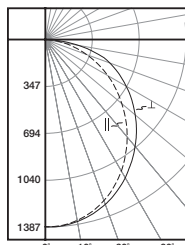

**24CZ-LD5-40-UNV-L835-CD1-U**

Electronic Driver  
 Linear LED 3500K  
 Spacing criterion:  
 (II) 1.2 x mounting  
 height, (⊥) 1.26 x  
 mounting height  
 Lumens: 3964  
 Input Watts: 29W  
 Efficacy: 136.7 lm/W  
 Test Report:  
 24CZ-LD5-40-UNV-  
 L835-CD1-U.IES

**Candlepower**

Angle	Along II	45°	Across ⊥
0	1385	1385	1385
5	1379	1375	1383
10	1355	1354	1364
15	1316	1322	1334
20	1261	1273	1292
25	1193	1213	1237
30	1115	1144	1174
35	1024	1064	1101
40	930	978	1023
45	830	889	943
50	726	797	857
55	623	704	770
60	519	608	679
65	415	512	590
70	309	417	497
75	211	326	375
80	116	219	234
85	45	87	81
90	0	0	0

**Coefficients of Utilization**

rc rw RCR	Effective floor cavity reflectance																						
	80%				70%				50%				30%				10%				0%		
0	119	119	119	119	116	116	116	116	111	111	111	111	106	106	106	106	102	102	102	102	100	100	
1	108	103	99	95	106	101	97	93	97	93	90	93	90	88	89	87	85	83	83	83	83	83	
2	98	90	83	77	96	88	81	76	84	79	74	81	76	72	78	74	71	68	68	68	68	68	
3	89	79	70	63	87	77	69	63	74	67	62	71	65	61	69	64	60	57	57	57	57	57	
4	82	69	60	54	79	68	60	53	66	58	52	63	57	52	61	56	51	49	49	49	49	49	
5	75	62	53	46	73	61	52	46	59	51	45	57	50	45	55	49	44	42	42	42	42	42	
6	69	56	47	40	67	55	46	40	53	45	40	51	44	39	50	44	39	37	37	37	37	37	
7	64	51	42	35	63	50	41	35	48	41	35	47	40	35	45	39	35	33	33	33	33	33	
8	60	46	38	32	58	45	37	32	44	37	31	43	36	31	42	36	31	29	29	29	29	29	
9	56	42	34	28	55	42	34	28	41	33	28	40	33	28	39	32	28	26	26	26	26	26	
10	52	39	31	26	51	39	31	26	38	31	26	37	30	26	36	30	25	24	24	24	24	24	

**Zonal Lumen Summary**

Zone	Lumens	% Fixture
0-30	1065	26.9
0-40	1731	43.7
0-60	3043	76.8
0-90	3964	100.0
0-180	3964	100.0

**Luminance Data**

Angle in Deg	Average 0-Deg cd/sm	Average 45-Deg cd/sm	Average 90-Deg cd/sm
45	1798	1926	2043
55	1664	1880	2056
65	1504	1856	2138
75	1249	1929	2219
85	791	1529	1423

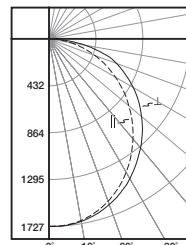

**24CZ-LD5-50-UNV-L835-CD1-U**

Electronic Driver  
 Linear LED 3500K  
 Spacing criterion:  
 (II) 1.2 x mounting  
 height, (⊥) 1.26 x  
 mounting height  
 Lumens: 4988  
 Input Watts: 40.6W  
 Efficacy: 122.9 lm/W  
 Test Report:  
 24CZ-LD5-50-UNV-  
 L835-CD1-U.IES

**Candlepower**

Angle	Along II	45°	Across ⊥
0	1726	1726	1726
5	1718	1712	1722
10	1689	1686	1699
15	1639	1644	1661
20	1572	1586	1607
25	1490	1512	1541
30	1392	1426	1463
35	1285	1330	1374
40	1170	1225	1284
45	1048	1116	1186
50	921	1005	1079
55	793	891	974
60	664	774	860
65	536	654	740
70	404	533	626
75	278	412	489
80	156	272	294
85	61	112	101
90	0	0	0

**Coefficients of Utilization**

rc rw RCR	Effective floor cavity reflectance																						
	80%				70%				50%				30%				10%				0%		
0	119	119	119	119	116	116	116	116	111	111	111	111	106	106	106	106	102	102	102	102	100	100	
1	108	103	99	95	105	101	97	93	97	93	90	93	90	87	89	87	85	83	83	83	83	83	
2	98	90	82	76	95	88	81	76	84	79	74	81	76	72	78	74	70	68	68	68	68	68	
3	89	78	70	63	87	77	69	63	74	67	62	71	65	61	69	64	60	57	57	57	57	57	
4	82	69	60	53	79	68	60	53	65	58	52	63	57	52	61	56	51	49	49	49	49	49	
5	75	62	53	46	73	61	52	46	59	51	45	57	50	45	55	49	44	42	42	42	42	42	
6	69	56	47	40	67	55	46	40	53	45	39	51	44	39	50	43	39	37	37	37	37	37	
7	64	50	42	35	62	50	41	35	48	40	35	47	40	35	45	39	34	32	32	32	32	32	
8	60	46	37	31	58	45	37	31	44	36	31	44	36	31	43	36	31	29	29	29	29	29	
9	56	42	34	28	54	42	34	28	40	33	28	39	33	28	39	33	28	26	26	26	26	26	
10	52	39	31	26	51	38	31	26	37	30	25	36	30	25	36	30	25	23	23	23	23	23	

**Zonal Lumen Summary**

Zone	Lumens	% Fixture
0-30	1326	26.6
0-40	2159	43.3
0-60	3815	76.5
0-90	4988	100.0
0-180	4988	100.0

**Luminance Data**

Angle in Deg	Average 0-Deg cd/sm	Average 45-Deg cd/sm	Average 90-Deg cd/sm
45	2270	2417	2569
55	2118	2379	2601
65	1943	2370	2682
75	1645	2438	2775
85	1072	1968	1775

## ENERGY AND PERFORMANCE DATA BY CATALOG NUMBER

Stock or MTO*	Catalog Logic (Ribbed Lens)	Delivered Lumens	Watts	Efficacy (lm/W)
MTO	24CZ-LD5-30-UNV-L830-CD1-U	2833	21.6	131
MTO	24CZ-LD5-30-UNV-L835-CD1-U	3010	21.6	139
MTO	24CZ-LD5-30-UNV-L840-CD1-U	3070	21.6	142
MTO	24CZ-LD5-30-UNV-L850-CD1-U	3321	21.6	154
MTO	24CZ-LD5-35-UNV-L830-CD1-U	3289	25.3	130
MTO	24CZ-LD5-35-UNV-L835-CD1-U	3494	25.3	138
MTO	24CZ-LD5-35-UNV-L840-CD1-U	3564	25.3	141
MTO	24CZ-LD5-35-UNV-L850-CD1-U	3855	25.3	152
MTO	24CZ-LD5-40-UNV-L830-CD1-U	3731	29.0	128
STOCK	24CZ-LD5-40-UNV-L835-CD1-U	3964	29.0	137
STOCK	24CZ-LD5-40-UNV-L840-CD1-U	4043	29.0	139
MTO	24CZ-LD5-40-UNV-L850-CD1-U	4374	29.0	151
MTO	24CZ-LD5-45-UNV-L830-CD1-U	4207	35.7	118
MTO	24CZ-LD5-45-UNV-L835-CD1-U	4469	35.7	125
MTO	24CZ-LD5-45-UNV-L840-CD1-U	4558	35.7	128
MTO	24CZ-LD5-45-UNV-L850-CD1-U	4931	35.7	138
MTO	24CZ-LD5-50-UNV-L830-CD1-U	4695	40.7	115
STOCK	24CZ-LD5-50-UNV-L835-CD1-U	4988	40.7	123
STOCK	24CZ-LD5-50-UNV-L840-CD1-U	5088	40.7	125
MTO	24CZ-LD5-50-UNV-L850-CD1-U	5503	40.7	135
MTO	24CZ-LD5-55-UNV-L830-CD1-U	5181	45.8	113
MTO	24CZ-LD5-55-UNV-L835-CD1-U	5504	45.8	120
MTO	24CZ-LD5-55-UNV-L840-CD1-U	5614	45.8	123
MTO	24CZ-LD5-55-UNV-L850-CD1-U	6073	45.8	133
MTO	24CZ-LD5-60-UNV-L830-CD1-U	5741	52.2	110
MTO	24CZ-LD5-60-UNV-L835-CD1-U	6099	52.2	117
MTO	24CZ-LD5-60-UNV-L840-CD1-U	6221	52.2	119
MTO	24CZ-LD5-60-UNV-L850-CD1-U	6729	52.2	129
MTO	24CZ-LD5-65-UNV-L830-CD1-U	6193	57.6	107
MTO	24CZ-LD5-65-UNV-L835-CD1-U	6579	57.6	114
MTO	24CZ-LD5-65-UNV-L840-CD1-U	6711	57.6	116
MTO	24CZ-LD5-65-UNV-L850-CD1-U	7259	57.6	126
MTO	24CZ-LD5-70-UNV-L830-CD1-U	6668	64.2	104
MTO	24CZ-LD5-70-UNV-L835-CD1-U	7084	64.2	110
MTO	24CZ-LD5-70-UNV-L840-CD1-U	7226	64.2	113
MTO	24CZ-LD5-70-UNV-L850-CD1-U	7816	64.2	122
MTO	24CZ-LD5-75-UNV-L830-CD1-U	7052	69.1	102
MTO	24CZ-LD5-75-UNV-L835-CD1-U	7491	69.1	108
MTO	24CZ-LD5-75-UNV-L840-CD1-U	7641	69.1	111
MTO	24CZ-LD5-75-UNV-L850-CD1-U	8265	69.1	120

\*Made to order (MTO) requires a typical three week lead time.

## Standard Efficacy Versions

Stock or MTO*	Catalog Logic (Ribbed Lens)	Delivered Lumens	Watts	Efficacy (lm/W)
MTO	24CZ-LD5-30SE-UNV-L830-CD1-U	2878	23.5	122
STOCK	24CZ-LD5-30SE-UNV-L835-CD1-U	3057	23.5	130
STOCK	24CZ-LD5-30SE-UNV-L840-CD1-U	3118	23.5	133
MTO	24CZ-LD5-30SE-UNV-L850-CD1-U	3373	23.5	144
MTO	24CZ-LD5-35SE-UNV-L830-CD1-U	3324	28.6	116
STOCK	24CZ-LD5-35SE-UNV-L835-CD1-U	3531	28.6	124
STOCK	24CZ-LD5-35SE-UNV-L840-CD1-U	3602	28.6	126
MTO	24CZ-LD5-35SE-UNV-L850-CD1-U	3896	28.6	136
MTO	24CZ-LD5-40SE-UNV-L830-CD1-U	3783	32.6	116
STOCK	24CZ-LD5-40SE-UNV-L835-CD1-U	4019	32.6	123
STOCK	24CZ-LD5-40SE-UNV-L840-CD1-U	4099	32.6	126
MTO	24CZ-LD5-40SE-UNV-L850-CD1-U	4434	32.6	136
MTO	24CZ-LD5-45SE-UNV-L830-CD1-U	4304	39.9	108
STOCK	24CZ-LD5-45SE-UNV-L835-CD1-U	4572	39.9	115
STOCK	24CZ-LD5-45SE-UNV-L840-CD1-U	4663	39.9	117
MTO	24CZ-LD5-45SE-UNV-L850-CD1-U	5044	39.9	126
MTO	24CZ-LD5-50SE-UNV-L830-CD1-U	4788	46.6	103
STOCK	24CZ-LD5-50SE-UNV-L835-CD1-U	5086	46.6	109
STOCK	24CZ-LD5-50SE-UNV-L840-CD1-U	5188	46.6	111
MTO	24CZ-LD5-50SE-UNV-L850-CD1-U	5612	46.6	121
MTO	24CZ-LD5-55SE-UNV-L830-CD1-U	5216	54.7	95
MTO	24CZ-LD5-55SE-UNV-L835-CD1-U	5541	54.7	101
MTO	24CZ-LD5-55SE-UNV-L840-CD1-U	5652	54.7	103
MTO	24CZ-LD5-55SE-UNV-L850-CD1-U	6114	54.7	112
MTO	24CZ-LD5-60SE-UNV-L830-CD1-U	5611	60.0	94
MTO	24CZ-LD5-60SE-UNV-L835-CD1-U	5961	60.0	99
MTO	24CZ-LD5-60SE-UNV-L840-CD1-U	6080	60.0	101
MTO	24CZ-LD5-60SE-UNV-L850-CD1-U	6577	60.0	110
MTO	24CZ-LD5-65SE-UNV-L830-CD1-U	6154	59.6	103
MTO	24CZ-LD5-65SE-UNV-L835-CD1-U	6537	59.6	110
MTO	24CZ-LD5-65SE-UNV-L840-CD1-U	6668	59.6	112
MTO	24CZ-LD5-65SE-UNV-L850-CD1-U	7213	59.6	121

\*Made to order (MTO) requires a typical three week lead time.

## ENERGY AND PERFORMANCE DATA BY CATALOG NUMBER

Stock or MTO*	Catalog Logic (Smooth Lens)	Delivered Lumens	Watts	Efficacy (lm/W)
MTO	24CZ-LD5-30-S-UNV-L830-CD1-U	2890	21.6	134
MTO	24CZ-LD5-30-S-UNV-L835-CD1-U	3070	21.6	142
MTO	24CZ-LD5-30-S-UNV-L840-CD1-U	3132	21.6	145
MTO	24CZ-LD5-30-S-UNV-L850-CD1-U	3387	21.6	157
MTO	24CZ-LD5-35-S-UNV-L830-CD1-U	3355	25.3	132
MTO	24CZ-LD5-35-S-UNV-L835-CD1-U	3564	25.3	141
MTO	24CZ-LD5-35-S-UNV-L840-CD1-U	3635	25.3	144
MTO	24CZ-LD5-35-S-UNV-L850-CD1-U	3932	25.3	155
MTO	24CZ-LD5-40-S-UNV-L830-CD1-U	3806	29.0	131
MTO	24CZ-LD5-40-S-UNV-L835-CD1-U	4043	29.0	139
MTO	24CZ-LD5-40-S-UNV-L840-CD1-U	4124	29.0	142
MTO	24CZ-LD5-40-S-UNV-L850-CD1-U	4461	29.0	154
MTO	24CZ-LD5-45-S-UNV-L830-CD1-U	4291	35.7	120
MTO	24CZ-LD5-45-S-UNV-L835-CD1-U	4558	35.7	128
MTO	24CZ-LD5-45-S-UNV-L840-CD1-U	4650	35.7	130
MTO	24CZ-LD5-45-S-UNV-L850-CD1-U	5029	35.7	141
MTO	24CZ-LD5-50-S-UNV-L830-CD1-U	4789	40.7	118
MTO	24CZ-LD5-50-S-UNV-L835-CD1-U	5088	40.7	125
MTO	24CZ-LD5-50-S-UNV-L840-CD1-U	5190	40.7	128
MTO	24CZ-LD5-50-S-UNV-L850-CD1-U	5614	40.7	138
MTO	24CZ-LD5-55-S-UNV-L830-CD1-U	5285	45.8	115
MTO	24CZ-LD5-55-S-UNV-L835-CD1-U	5614	45.8	123
MTO	24CZ-LD5-55-S-UNV-L840-CD1-U	5726	45.8	125
MTO	24CZ-LD5-55-S-UNV-L850-CD1-U	6194	45.8	135
MTO	24CZ-LD5-60-S-UNV-L830-CD1-U	5856	52.2	112
MTO	24CZ-LD5-60-S-UNV-L835-CD1-U	6221	52.2	119
MTO	24CZ-LD5-60-S-UNV-L840-CD1-U	6345	52.2	122
MTO	24CZ-LD5-60-S-UNV-L850-CD1-U	6864	52.2	132
MTO	24CZ-LD5-65-S-UNV-L830-CD1-U	6317	57.6	110
MTO	24CZ-LD5-65-S-UNV-L835-CD1-U	6711	57.6	116
MTO	24CZ-LD5-65-S-UNV-L840-CD1-U	6845	57.6	119
MTO	24CZ-LD5-65-S-UNV-L850-CD1-U	7404	57.6	128
MTO	24CZ-LD5-70-S-UNV-L830-CD1-U	6802	64.2	106
MTO	24CZ-LD5-70-S-UNV-L835-CD1-U	7226	64.2	113
MTO	24CZ-LD5-70-S-UNV-L840-CD1-U	7370	64.2	115
MTO	24CZ-LD5-70-S-UNV-L850-CD1-U	7972	64.2	124
MTO	24CZ-LD5-75-S-UNV-L830-CD1-U	7193	69.1	104
MTO	24CZ-LD5-75-S-UNV-L835-CD1-U	7641	69.1	111
MTO	24CZ-LD5-75-S-UNV-L840-CD1-U	7794	69.1	113
MTO	24CZ-LD5-75-S-UNV-L850-CD1-U	8430	69.1	122

\*Made to order (MTO) requires a typical three week lead time.

## Standard Efficacy Versions

Stock or MTO*	Catalog Logic (Smooth Lens)	Delivered Lumens	Watts	Efficacy (lm/W)
MTO	24CZ-LD5-30SE-S-UNV-L830-CD1-U	2935	23.5	125
MTO	24CZ-LD5-30SE-S-UNV-L835-CD1-U	3118	23.5	133
MTO	24CZ-LD5-30SE-S-UNV-L840-CD1-U	3181	23.5	135
MTO	24CZ-LD5-30SE-S-UNV-L850-CD1-U	3440	23.5	146
MTO	24CZ-LD5-35SE-S-UNV-L830-CD1-U	3390	28.6	119
MTO	24CZ-LD5-35SE-S-UNV-L835-CD1-U	3602	28.6	126
MTO	24CZ-LD5-35SE-S-UNV-L840-CD1-U	3674	28.6	129
MTO	24CZ-LD5-35SE-S-UNV-L850-CD1-U	3974	28.6	139
MTO	24CZ-LD5-40SE-S-UNV-L830-CD1-U	3859	32.6	119
MTO	24CZ-LD5-40SE-S-UNV-L835-CD1-U	4099	32.6	126
MTO	24CZ-LD5-40SE-S-UNV-L840-CD1-U	4181	32.6	128
MTO	24CZ-LD5-40SE-S-UNV-L850-CD1-U	4523	32.6	139
MTO	24CZ-LD5-45SE-S-UNV-L830-CD1-U	4390	39.9	110
MTO	24CZ-LD5-45SE-S-UNV-L835-CD1-U	4663	39.9	117
MTO	24CZ-LD5-45SE-S-UNV-L840-CD1-U	4757	39.9	119
MTO	24CZ-LD5-45SE-S-UNV-L850-CD1-U	5145	39.9	129
MTO	24CZ-LD5-50SE-S-UNV-L830-CD1-U	4883	46.6	105
MTO	24CZ-LD5-50SE-S-UNV-L835-CD1-U	5188	46.6	111
MTO	24CZ-LD5-50SE-S-UNV-L840-CD1-U	5291	46.6	114
MTO	24CZ-LD5-50SE-S-UNV-L850-CD1-U	5724	46.6	123
MTO	24CZ-LD5-55SE-S-UNV-L830-CD1-U	5320	54.7	97
MTO	24CZ-LD5-55SE-S-UNV-L835-CD1-U	5652	54.7	103
MTO	24CZ-LD5-55SE-S-UNV-L840-CD1-U	5765	54.7	105
MTO	24CZ-LD5-55SE-S-UNV-L850-CD1-U	6236	54.7	114
MTO	24CZ-LD5-60SE-S-UNV-L830-CD1-U	5724	60.0	95
MTO	24CZ-LD5-60SE-S-UNV-L835-CD1-U	6080	60.0	101
MTO	24CZ-LD5-60SE-S-UNV-L840-CD1-U	6202	60.0	103
MTO	24CZ-LD5-60SE-S-UNV-L850-CD1-U	6709	60.0	112
MTO	24CZ-LD5-65SE-S-UNV-L830-CD1-U	6277	59.6	105
MTO	24CZ-LD5-65SE-S-UNV-L835-CD1-U	6668	59.6	112
MTO	24CZ-LD5-65SE-S-UNV-L840-CD1-U	6801	59.6	114
MTO	24CZ-LD5-65SE-S-UNV-L850-CD1-U	7357	59.6	123

\*Made to order (MTO) requires a typical three week lead time.

Ambient Temperature	TM-21 Lumen Maintenance (60,000 hours)	Theoretical L70 (Hours)
25°C	> 80%	> 186,000

Lumen Adjustment Factors 80->90 CRI	
3000K	0.88
3500K	0.861
4000K	0.865
5000K	0.87

**Example of Lumen Adjustment Calculation**

24CZ-LD5-40-UNV-L835-CD1-U  
at 90CRI at 3500K

Lumen Adjustment Factor = 0.861

Total Light Output =  
3,964 lm x 0.861 = 3,413 lm

Efficacy =  $\frac{3,413 \text{ lm}}{29 \text{ W}} = 117.6 \text{ lm/W}$

**ORDERING INFORMATION**

SAMPLE NUMBER: 24CZ-LD5-45-UNV-L835-CD1-U

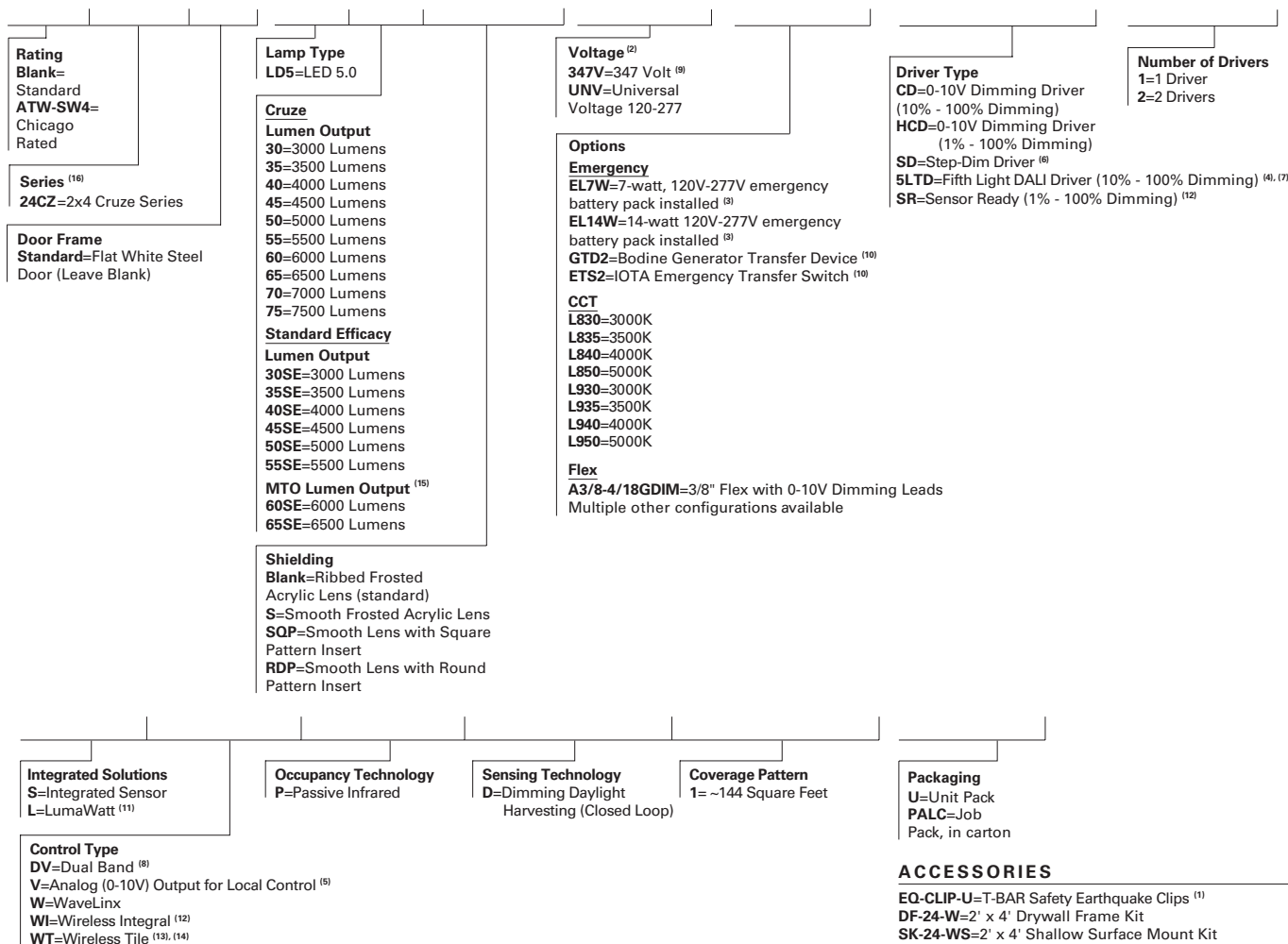

**ACCESSORIES**

- EQ-CLIP-U=T-BAR Safety Earthquake Clips
- DF-24-W=2' x 4' Drywall Frame Kit
- SK-24-WS=2' x 4' Shallow Surface Mount Kit
- SK-24-WT=2' x 4' Tall Surface Mount Kit
- DF10P-C=Decorator Dimmer, 0-10V
- SF10P-=Decorator Slide Dimmer, 0-10V
- ISHH-01=Programming Remote for Integrated Sensor
- ISHH-02=Personal Control Remote for Integrated Sensor

**NOTES:** (1)An EQ Grid Clip is recommended for all 9/16" ceiling systems. Four required per fixture. (2)Products also available in non-US voltages and frequencies for international markets. (3)With integral test switch/indicator/laser test. For approximate delivered lumens multiply the lumens per watt of the desired fixture by the wattage of the emergency battery pack (100 lm/W x 7=700 lumens). IES-format photometry for luminaire under emergency operation available. (4)Must be used in conjunction with a DALI control system. For a complete listing of Fifth Light Technology products and other solutions from Cooper Controls, visit www.eaton.com/lightingsystems. (5)Integral sensor works with CD and HCD drivers and is factory prewired to the driver for stand-alone control. (6)Step dim driver option is not available with 3000, 3500, 4000, 7000 and 7500 lumen packages and 3000SE, 3500SE, 6000SE and 6500SE versions. (7)Fifth Light (5LTD) driver option is not available with 3000, 3500 and 4000 lumen packages and 3000SE and 3500SE versions. (8)Provides blank band on opposite side from sensor band to provide symmetric appearance. (9)347V versions are not available with emergency options. 347V driver option requires two drivers with 7000 and 7500 lumen packages. SD, 5LTD, and SR drivers with 347V are available but not DLC qualified. (10)Used to transfer fixture to secondary power source for life-safety operation. When used with a dimming fixture, two devices are required to ensure control is disabled while operating under emergency power. (11)Must be used in conjunction with a LumaWatt Pro control system. For complete LumaWatt Pro wireless solutions, visit www.eaton.com/lumawattpro. (12)SR driver compatible with LWI option only. (13)LWT compatible with CD and HCD drivers only. (14)LWT sensor is external to luminaire, cable factory wired. (15)Made-to-order (MTO) requires a typical three week leadtime. (16)DesignLights Consortium® Qualified and classified for both DLC Standard and DLC Premium, refer to www.designlights.org for details.

Specifications & dimensions subject to change without notice. Consult your Eaton Representative for availability and ordering information.

**SHIPPING DATA**

Catalog No.	Wt.
24CZ-LD5-45	20.5 lbs.
24CZ-LD5-55	20.5 lbs.



Eaton  
1121 Highway 74 South  
Peachtree City, GA 30269  
P: 770-486-4800  
www.eaton.com/lighting

Specifications and dimensions subject to change without notice.

**INTEGRATED SENSOR**

The Cruze with Integrated Sensor technology provides automatic energy savings without sacrificing performance. Traditionally, these types of energy savings required coordination between the luminaire and a lighting control system. The Cruze delivers superior lighting with integrated occupancy and daylighting controls.

Capture the benefits of traditional lighting controls, without complicated coverage planning or special wiring. Ideal for new construction or retrofit, the Cruze delivers automatic ON to an energy saving light level, while ensuring lighting is turned OFF when the space is unoccupied.

The integral daylight sensor reduces the need for special daylight zone planning. Each luminaire will automatically adjust the light level based on reflected light beneath the sensor in a closed loop method.

Occupied daylight light levels and unoccupied light levels can be adjusted using the integrated sensor programming remote (Catalog Number: ISHH-01). The integrated sensor personal remote (Catalog Number: ISHH-02) provides code compliant manual raise, lower, ON, OFF control.

The Cruze with Integrated Sensor is easy to install with no special wiring and ensures energy savings out-of-the-box with default control settings.

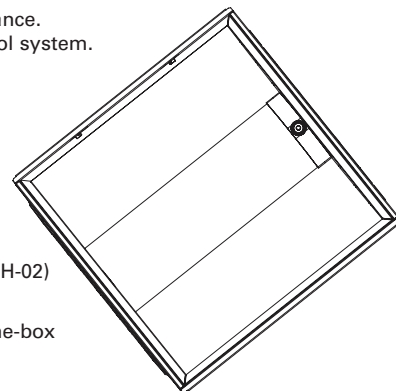

**How it works:**

- As the user enters the space controlled by the integral sensor, the lighting turns ON to the default daylight level.
- Lighting will remain at that the daylight level until the space is unoccupied. This will start the occupancy timeout period (default 20 minutes).
- If the space remains unoccupied for half of the timeout period, the lighting will automatically reduce to the Energy Saver light level. This adjustable light level is typically half of the occupied daylight level.
- At the end of the timeout period the lighting will go to the unoccupied light level. This adjustable light level uses the OFF default setting.

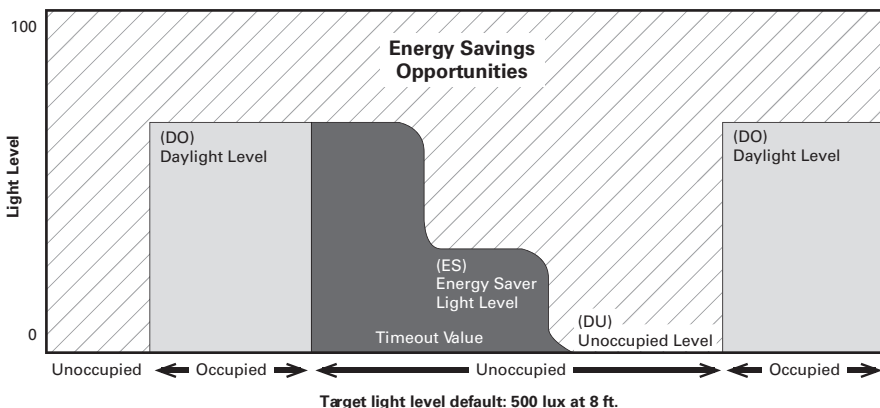

**Coverage**

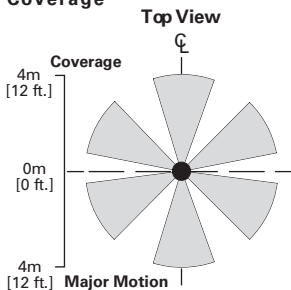

**Side View**

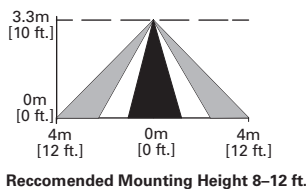

**Optional Remote Controls**



**ISHH-01 Programming Remote**



**ISHH-02 Personal Control Remote**