

# INSTRUCTIONS FOR 21 " UNIT MODEL 87212WT 87212SN 8721201

BEFORE YOU START:

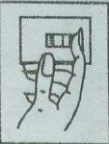

Turn wall switch OFF  
Apague el switch de la pared



Switch main power OFF  
Apague el switch principal de la caja



Or unscrew circuit fuse  
O desconecte el fusible del circuito

**IMPORTANT**  
• FIXTURE'S GROUND WIRE MUST BE CONNECTED FOR LAMP TO OPERATE.

**IMPORTANTE**  
• EL ALAMBRE DE TIERRA DEL APARATO DEBE SER CONECTADO PARA QUE LA LAMPARA OPERE.

**CAUTION:** IF POWER SUPPLY WIRES OR CORDS ARE LOCATED WITHIN THREE INCHES OF BALLAST, USE WIRE OR CORD SUITABLE FOR AT LEAST 90°C (194°F). TO PREVENT RISK OF FIRE, DO NOT USE FIXTURE ON DIMMING CIRCUITS.

**PRECAUCION:** SI LOS ALAMBRES O CORDONES DE PODER ELECTRICO ESTAN LOCALIZADOS ENTRE TRES PULGADAS DEL TRANSFORMADOR, USE ALAMBRES O CORDONES QUE SEAN A LO MENOS DE 90°C (194°F). PARA EVITAR EL RIESGO DE FUEGO, NO USE EL APARATO CON ATENUADORES DE LUZ.

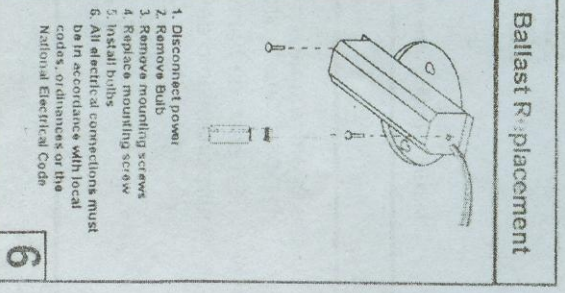
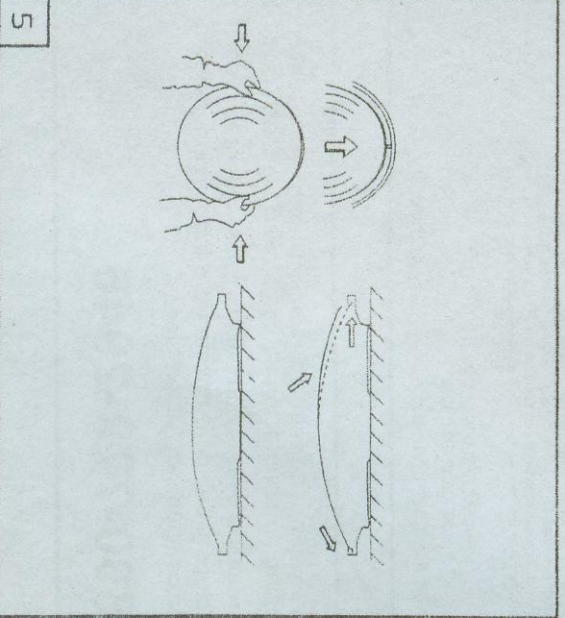
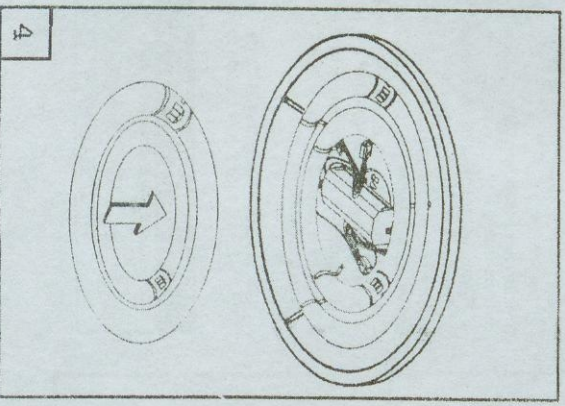
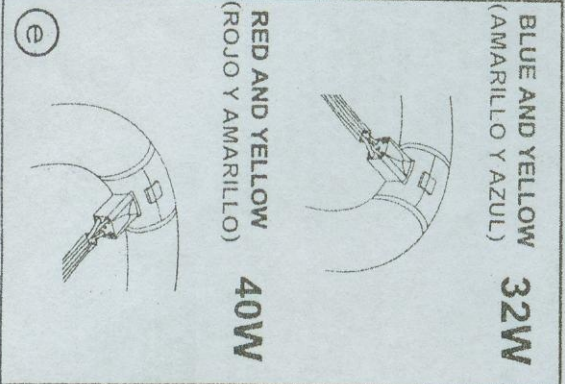
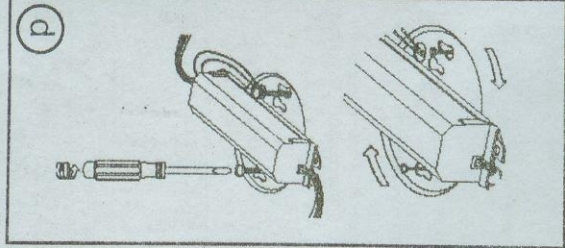
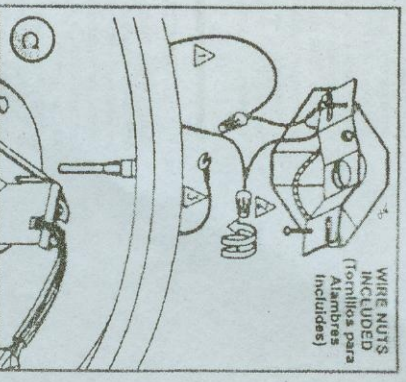
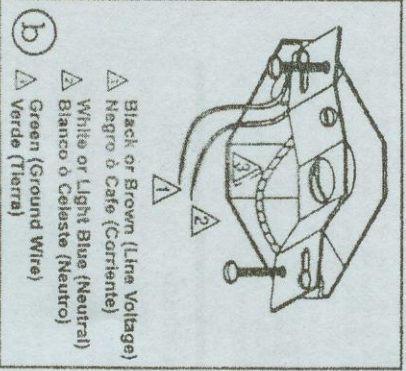
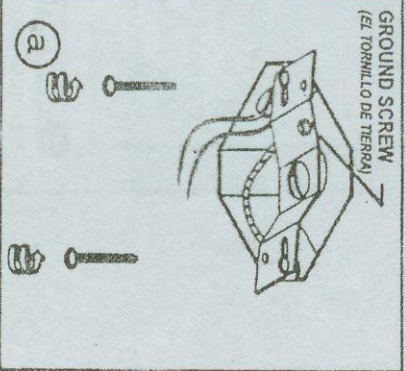
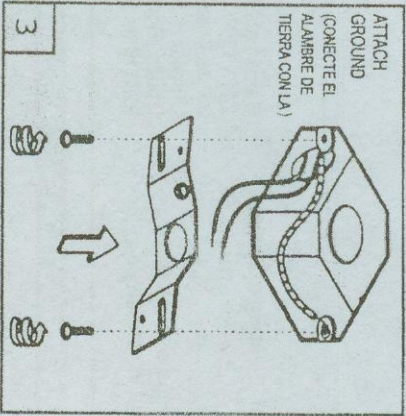
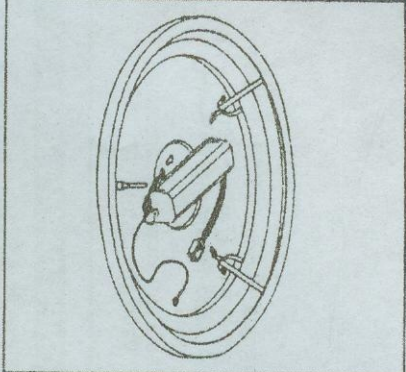
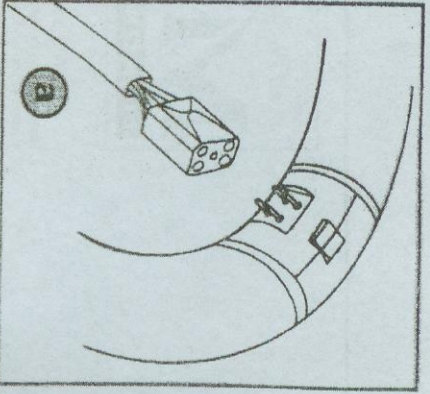
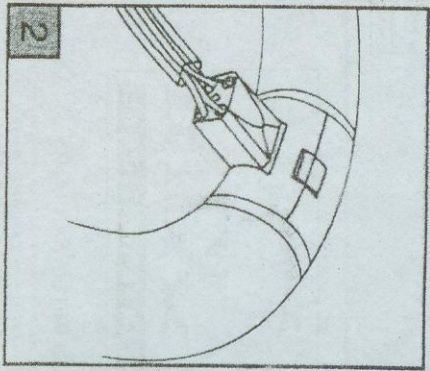
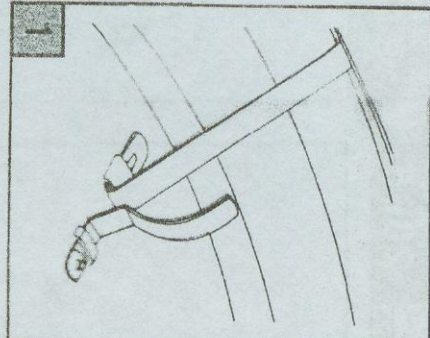

WIRE NUTS INCLUDED (Tornillos para incluir)

### Ballast Replacement

1. Disconnect power
2. Remove Bulb
3. Remove mounting screws
4. Replace mounting screw
5. Install bulb
6. All electrical connections must be in accordance with local codes, ordinances or the National Electrical Code