

1. Insert the glass into the metal frame.
2. Attach the diffuser to the wall plate by insert the screw into the key hole on the strap, then secure it by hux nut.

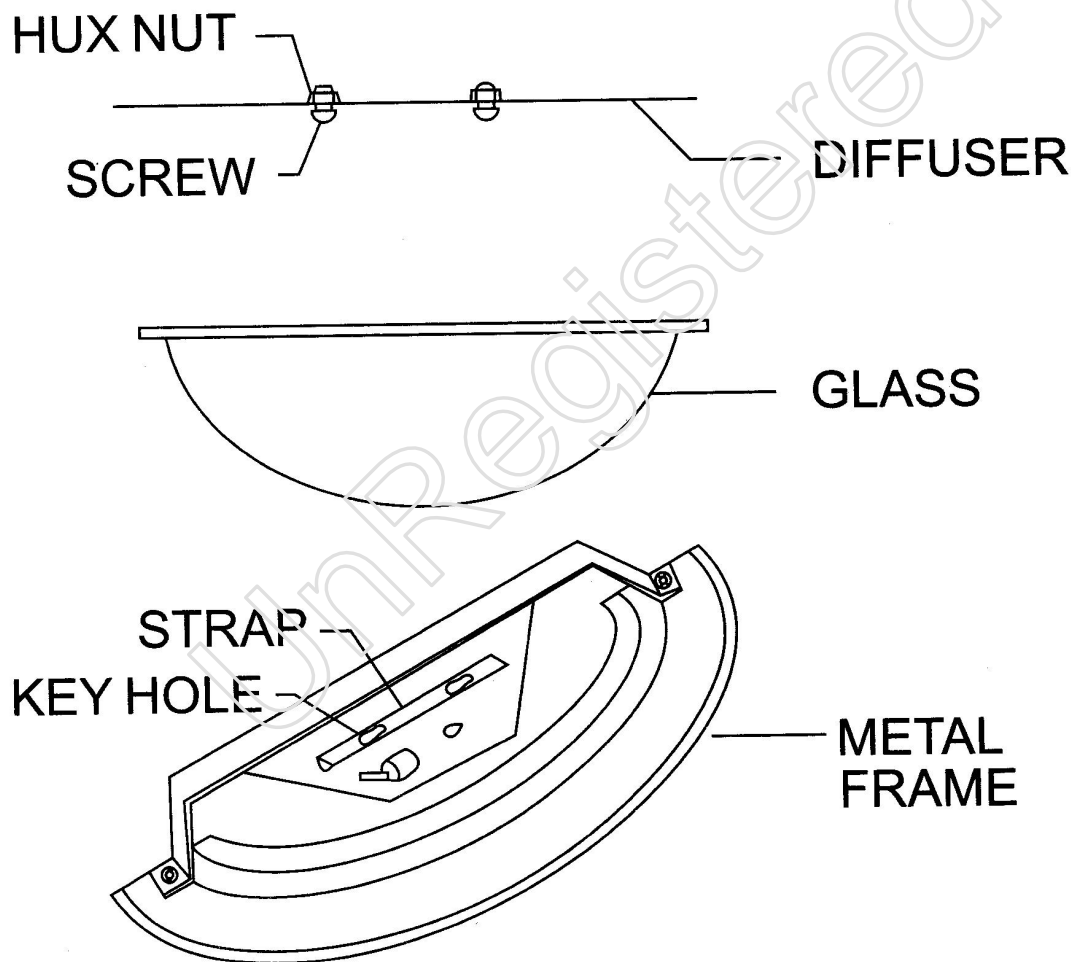

ALTERNATIVE MOUNTING METHOD (Fig. 2) HC-107

THIS FIXTURE CAN BE MOUNTED TO A WALL WITHOUT AN OUTLET BOX, MAKING THE WIRING CONNECTION BETWEEN THE FACEPLATE AND BACKPLATE.

1. Remove knock-out the backplate (if applicable), or remove plastic bushing.
2. Install Romex / Bx connector on the backplate.
3. Feed house supply wires through Romex / Bx connector, and secure.
4. Make wiring connection as described in the steps that follow, and tuck the wires between the faceplate and backplate.

INSTALLATION TO AN OUTLET BOX (Fig. 1)

STEP 1:

Punch out appropriate holes in backplate (C), if applicable, to correspond with holes in outlet box.







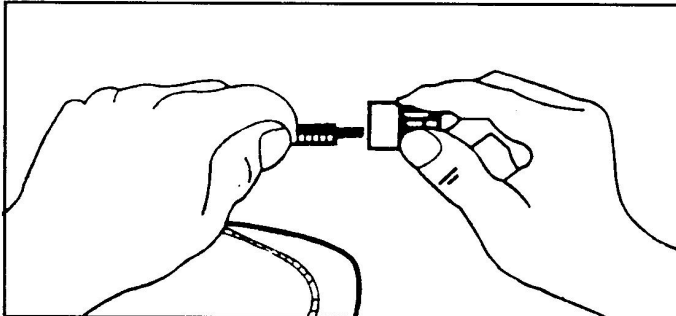

STEP 2:

Push socket wires thru plastic bushing

STEP 3:

A. Take note of the color of the wire (S) on your fixture. Identify which group your fixture wire(S) falls into and connect the wires according to the directions below:



GROUP A: CONNECT TO BLACK HOUSE WIRE	GROUP B: CONNECT TO WHITE HOUSE WIRE
BLACK 	WHITE 
*PARALLEL WIRE (ROUND & SMOOTH) 	*PARALLEL WIRE (ROUND & SMOOTH) 
WHITE OR GREY WITH TRACER 	WHITE OR GREY WITHOUT TRACER 
BROWN GOLD OR BLACK WITHOUT TRACER 	BROWN GOLD OR BLACK WITH TRACER 

NOTE: When parallel wire is used, the tracer wire is square shaped or ridged, and the less tracer wire is round in shape or smooth. (Seen best when viewed from wire end.) To separate wires, grasp the ends of each wire and pull apart.

B. Take your fixture wire(S) from group A and place evenly against the black wire from the outlet box. Do not twist wires together before using wire connectors.

C. Fit a wire connector (not supplied) over the wires and screw the connector clockwise until you feel a firmness.

D. Try gently to pull the connector off the wires. If you can pull the connector off. Carefully re-do steps B and C, as above, and check again for a firm connection.

E. Connect the fixture wire from group B to the white wire from the outlet box in the same manner.

STEP 4:

GROUNDING INSTRUCTIONS: The green grounding screw (A) is to be inserted into the hole with two raised dimples provided on the back plate (C). Wrap the ground wire from the fixture (if supplied) and the ground wire from the outlet box (bare metal or green insulated wire) around the green grounding screw (A) on the back plate (C).

NOTE: Underwriters Laboratories (U.L) does not require all fixtures to have ground wires. These fixtures still meet all U.L. Specifications. The listing mark of underwriters on the product identifies products manufactured under its Listing and Follow-up Service Programs.

NEVER CONNECT GROUND WIRE TO BLACK OR WHITE POWER SUPPLY WIRES.

FINAL ASSEMBLY

Make sure no bare wires can be seen outside wire connectors.

Note: Fixtures that employ a grounded type receptacle are not intended for connection to a two wire ungrounded source of supply.

STEP 1:

Tuck wires into outlet box. Attach backplate (C) to outlet box by placing outlet box screws (not supplied) through punched out holes in backplate (C).

If applicable: Wood screws (K) placed in outlet holes will provide additional support.

Note: Your fixture may be supplied with a faceplate (F), decorative front (E), or both, depending on your model. Follow the directions below according to the parts supplied with your fixture.

STEP 2:

Position faceplate (F) or decorative front (E) over sockets (J).

NOTE: If backplate (C) is supplied with mounting studs (H) position faceplate over studs and secure in place with cap nuts (G).

STEP 3:

For fixtures supplied with cups:

Push faceplate (F) or decorative front (E) to wall and secure by pushing cups (I) onto sockets (J) in a clockwise motion. (If your fixture is supplied with thread sockets, thread rings (L) onto sockets (J) in the same manner except screw them on) **NOTE:** If both decorative front (E) and faceplate (F) are supplied, place faceplate (F) and wood (or mirror), in that order, over sockets (J) before securing with cups or rings (L). **NOTE:** It may be necessary to bend tabs in cup (I) for a tight fit.

STEP 4:

Install lamps

CLEANING

To cleaning, wipe fixture with a soft cloth. Clean glass with a mild soap. Do not use abrasive materials such as scouring pads or powers, steel wool or abrasive paper.

ORDERING PARTS

Keep this sheet for future reference, and in case you need to order replacement parts. All parts for this fixture can be ordered from place of purchase. Be sure to use exact wording from illustration when ordering parts



INSTALLATION AND SAFETY INSTRUCTIONS

FOR YOUR SAFETY

WARNING: BE SURE THE ELECTRICITY TO THE WIRES YOU ARE WORKING ON IS SHUT OFF EITHER THE FUSE REMDVED OR THE CIRCUIT BREAKER OFF.

GENERAL

You don't need special tools to install this fixture. Be sure to follow the steps in the order given. Under no circumstances should a fixture be hung on house electrical wires, nor should a swag type fixture be installed on a calling which contains a radiant type heating system. Read instructions carefully. If you are unclear as to how to proceed, consult a qualified electrician.

NOTE: Proper wiring is essential for the safe operation of this fixture. See page 2 alternative mounting method.

ASSEMBLY

Carefully remove the fixture from the carton and check that all parts are included, as shown in the Figure 1. Be careful not to misplace any of the screws or parts which are needed to install this fixture.

STEP 1:

Peel protective coating off as follows:(If applicable). For easier removal, peel coating off at an angle holding it close to the fixture. Peel sides off before peeling the front faces.

NOTE: SOCKETS ARE FACTORY INSTALLED. IF SOCKET IS NOT SECURE TO BACKPLATE, MAKE SURE SOCKET TABS ARE SNAPPED ONTO PRE-DRILLED HOLES IN BACKPLATE.

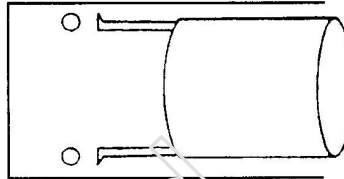

* OUTLET BOX
GROUND WIRE(D)

* WIRE
CONNECTOR

* OUTLET BOX

GREEN GROUNDING
SCREW(A)

EXTRUDED HCLE(B)

WOOD
SCREWS(K)

GCO GROUND WIRE
(IF APPLICABLE)

FACE PLATE(F)

BACKPLATE(C)

SOCKETS(J)

DECORATNE
FRONT(E)

FIGURE 1
*NOT SUPPLIED

BACK PLATE

*ROMEX/BX
CONNECTOR

* WIRE
CONNECTOR

FACE PLATE

FIGURE 2
*NOT SUPPLIED

MAXIM[®]
L I G H T I N G
WWW.MAXIMLIGHTING.COM