

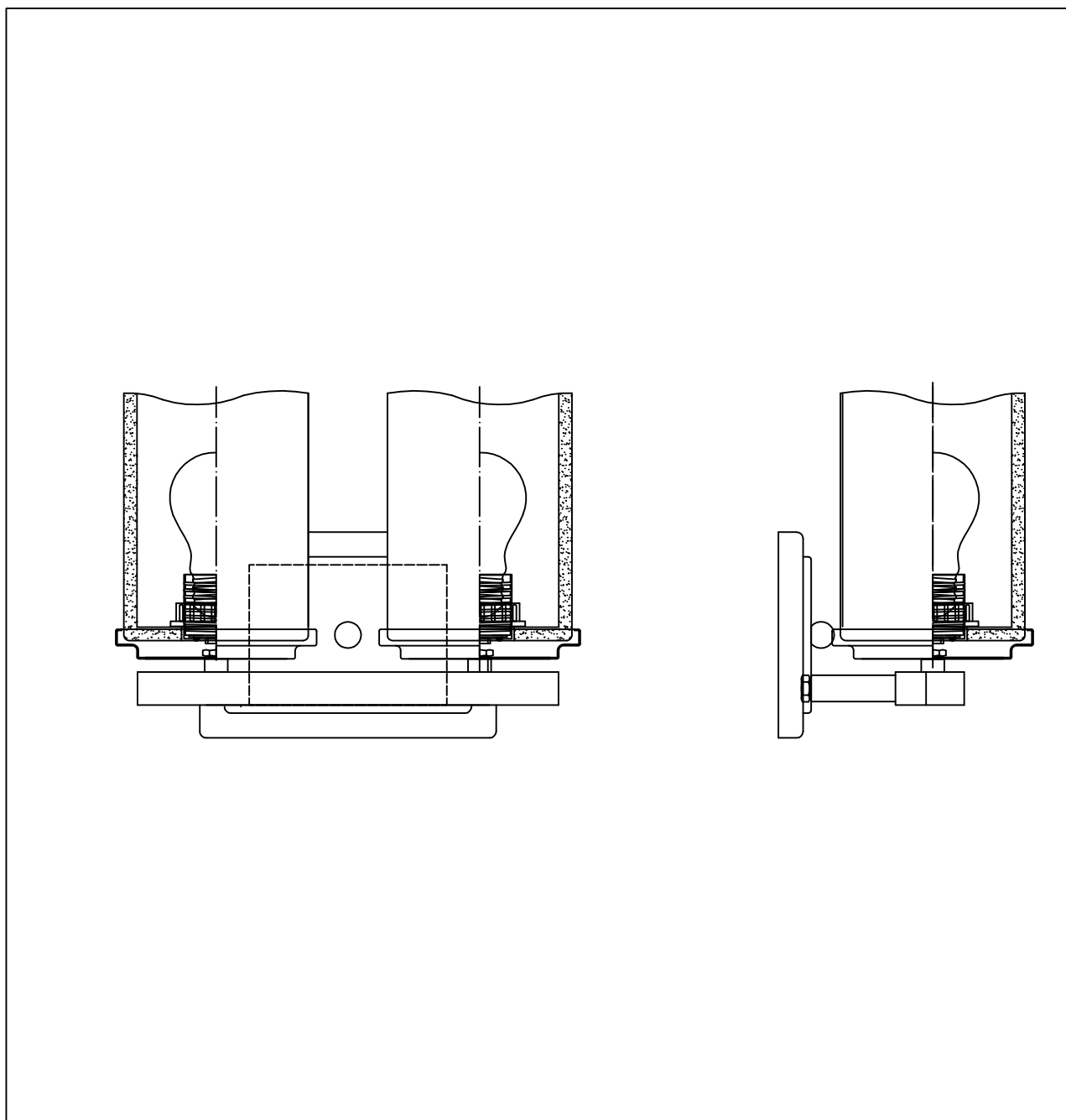

**PRODUCT NAME: Luminous**  
**ITEM NUMBER: 21142**

**Please consult your electrician for Hang fixture and wiring.**



**Bulb(not included) :2\*MB 60W**

**PRODUCTS ARE NOT INENDED  
FOR COMMERCIAL USE.**

**MADE IN CHINA**  
**Page 1 of (3)**

**IMPORTANT:** Turn off power at the main fuse or circuit breaker box before starting installation



(A) Bracket

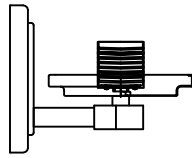

(B) Body



(C) Ball nut

### Locate all hardware & components before discarding packaging

1.)

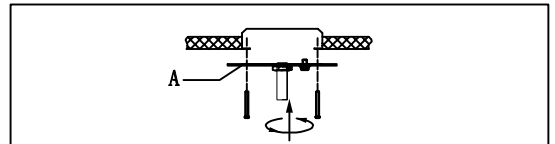

**Step. 1:** Remove mounting bracket(A) from fixture and install to electrical box.

2.)

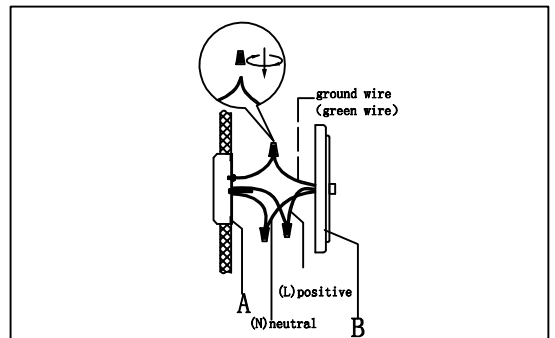

**Step. 2:** Wire fixture to wires in outlet box. Copper/Green wire is for Ground.

3.)

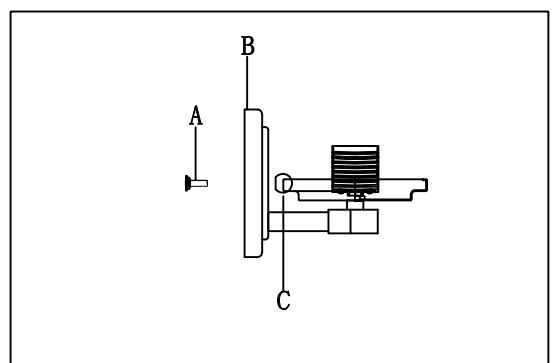

**Step. 3:** Install fixture to bracket(A) and tighten ball nuts (C) on the backplate to secure.

### Cleaning & Care:

Clean with soft cloth and a mild detergent.  
Do not use abrasive cleaner.

**IMPORTANT:** Turn off power at the main fuse or circuit breaker box before starting installation

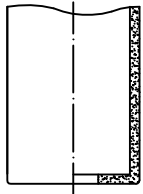

(D) Stone shade



(E) E27 Socket Ring



(F) Bulb

**Locate all hardware & components before discarding packaging**

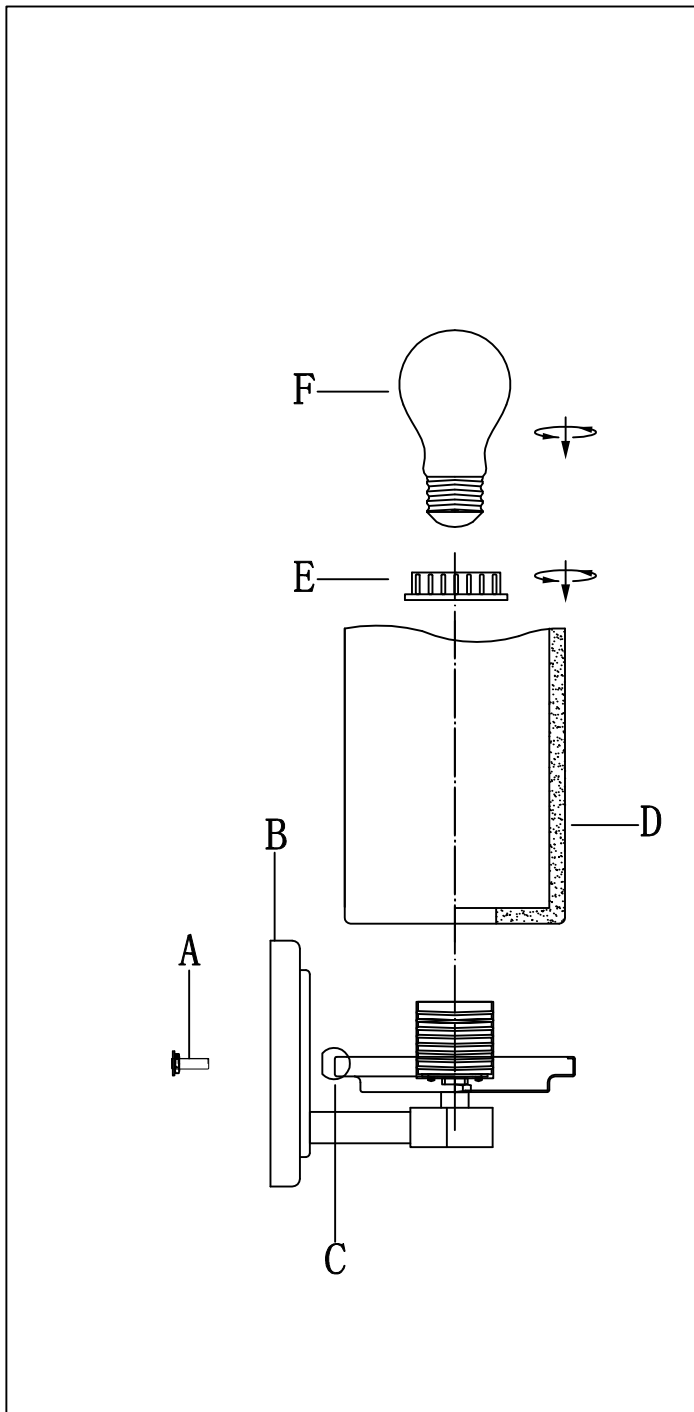

4.)

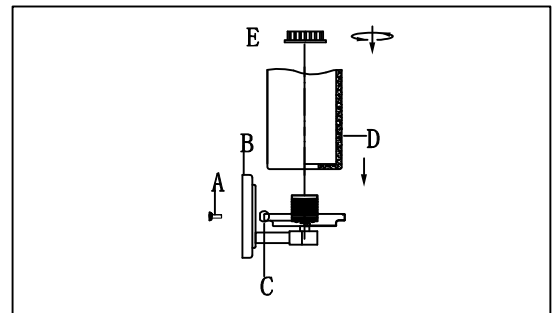

**Step. 4:** Place the Stone shade on the lamp body(C)

5.)

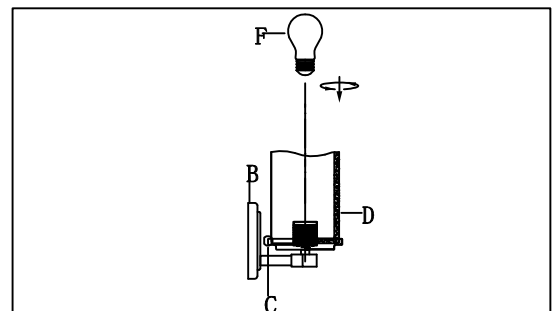

**Step. 5:** Install the bulb

**Cleaning & Care:**

Clean with soft cloth and a mild detergent.  
Do not use abrasive cleaner.