

Fresh Living Tip

Love desserts? This freezer features a flat shelf to quickly chill desserts such as cookie dough, chocolates and more. Or if fresh, healthy food is more your style, you can preserve fruits and vegetables in your Marvel All Freezer to enjoy any time, no matter the season.

FINISH OPTIONS



24" Marvel High-Capacity Freezer

MLFZ224

Storage Adaptability

- 4.7 total cu. ft.
- Keep items organized and within easy reach with (2) commercial-grade chrome wire freezer bins on the fully extendable smooth-glide ball bearing system
- Also includes (1) full-width adjustable cantilevered FreshFlo stainless steel shelf (removable)

Cooling Performance

- Dynamic cooling technology delivers rapid cool down, frost-free operation and precise temperature stability
- Proprietary internal design allows for cool air to circulate throughout cabinet for temperature consistency from top to bottom
- Thermal-efficient cabinet insulates cooling environment and conserves energy while maximizing capacity
- Sound-buffering design

Convenient Controls

- Multifunction controls allow you to select a precise temperature from -10° F to 10° F
- Features easy-to-use settings and options

Fit & Finish

- Arctic white interior easily wipes clean
- Efficient arctic white LED lighting illuminates interior for better viewing
- Reversible door allows for right or left swing for adaptable installation
- Black toe kick adjustable to 4" with leveling legs

Warranty

- 1-year parts and labor warranty and 5-year sealed system parts warranty



This high-capacity undercounter freezer model features two full-extension commercial-strength chrome baskets with the smooth-glide ball bearing system and a cantilevered FreshFlo stainless steel shelf.

DOOR STYLE

- Solid Stainless Steel
- Solid Panel Ready

MODEL NUMBER

- MLFZ224-SS01A
- MLFZ224-IS01A





H: 33 3/4" W: 23 7/8" D: 26 7/32" (with handle)

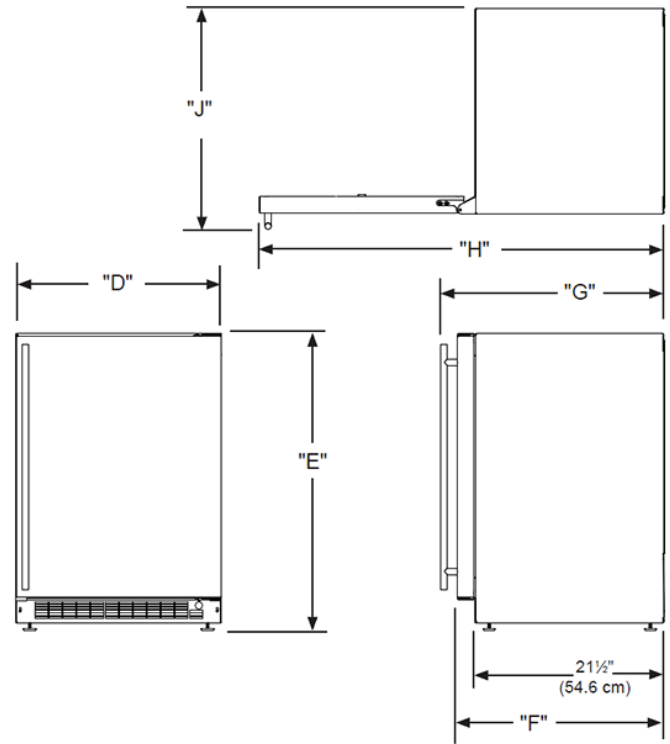
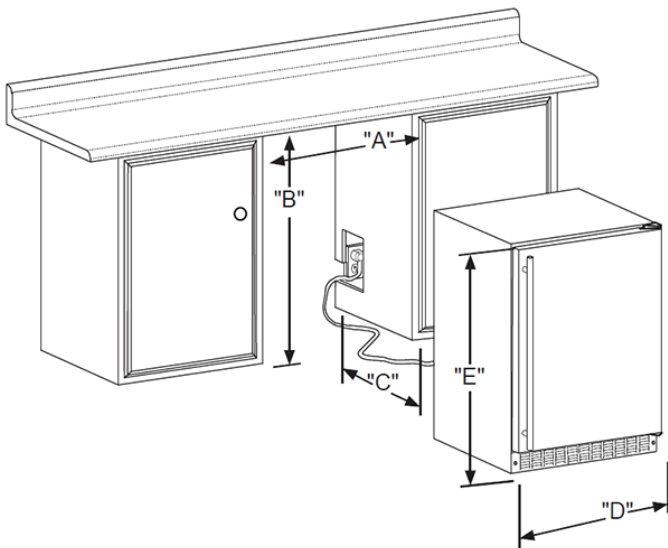

Rough In Dimensions*

"A"	"B"	"C"
24"	34-1/4" to 35-1/4"	24"
(61 CM)	(87 CM to 89.5 CM)	(61 CM)

Cabinet Dimensions*

"D"	"E"	"F"	"G"	"H"	"J"
23-7/8"	33-5/8" TO 34-5/8"	23-5/8"*	26-1/8"*	47-3/4"*	26-1/2"*
(60.7 CM)	(85.4 CM TO 87.9 CM)	(60 CM)	(66.3 CM)	(146.6 CM)	(67.3 CM)

*Stainless steel model dimensions only. For panel-ready models, see the owner's guide online at marvelrefrigeration.com.

Capacity	4.7 CU. FT.
Control Type	Electronic
Sabbath Mode	Yes
Temperature Range	-10° F to 10° F
Handle Style	Slim (handle not included on panel-ready models)
Hinge Type	Reversible
Interior Lighting	White LED
Shelving System	Cantilevered Shelf, Smooth-Glide Baskets
Toe Grille Finish	Black

Lock	No
Electrical Requirements	115V / 60 Hz / 15A
Cord Length	6 FT.
Shipping Dimensions	28" W x 31" D x 37" H
Shipping Weight	160 LBS
Agency Approval	UL
Refrigerant Type	R600a

For comprehensive installation instructions, including panel overlay details, please visit marvelrefrigeration.com to access the owner's guide.

