

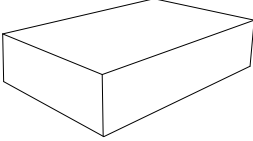









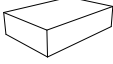





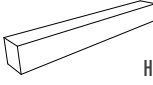

# ASSEMBLY INSTRUCTIONS

## INSET VANITY W/ 2 DRAWERS & 1 DOOR | VSD30(L/R)



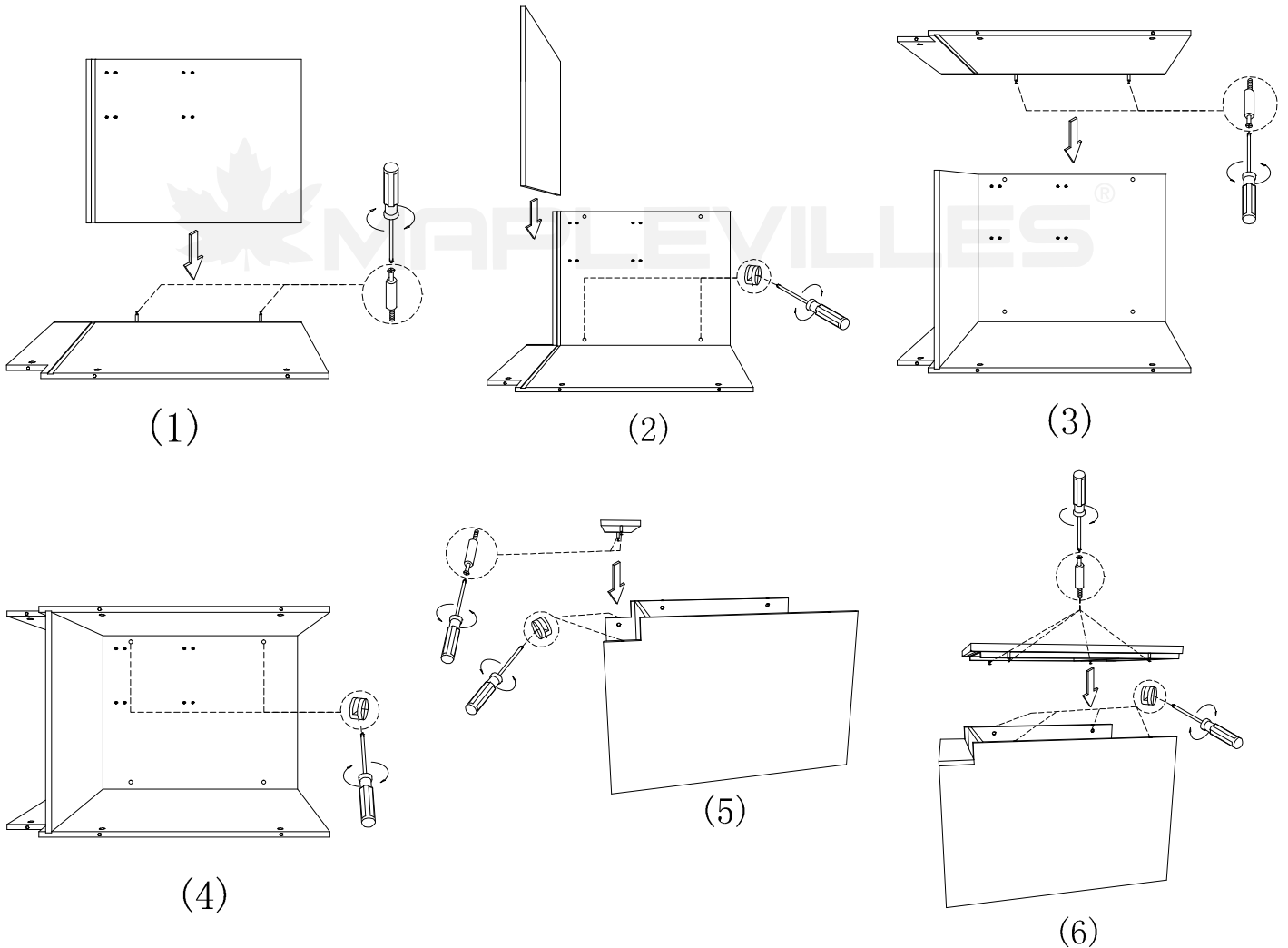

PACKAGING	ITEM	ITEM CODE	QTY	PACKAGING	ITEM	DESCRIPTION	QTY
		TOOLS REQUIRED: 1. PHILLIPS SCREWDRIVER 2. DRILL		 HARDWARE BOX		HINGES	2
		A-1	1			CAM LOCK	10
		A-2	1			16MM SCREW	32
		F B	1			CAM LOCK SCREW	10
		C	1	 DRAWER HARDWARE		30MM SCREW	2
		D	1			DRAWER TRACK	4
		E	1			REAR TRACK HOLDER	4
		J	4			TRACK CLIPS	4
		H	1				

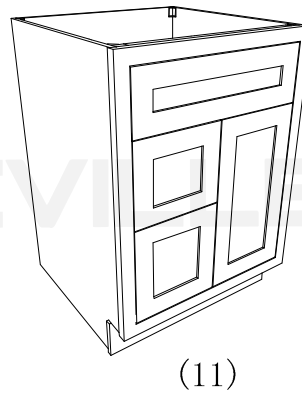
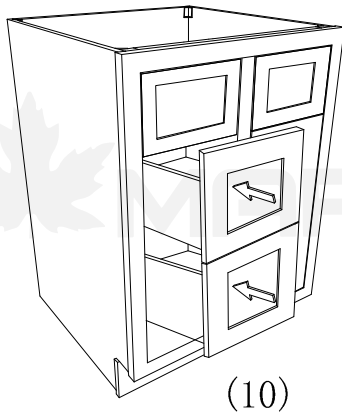
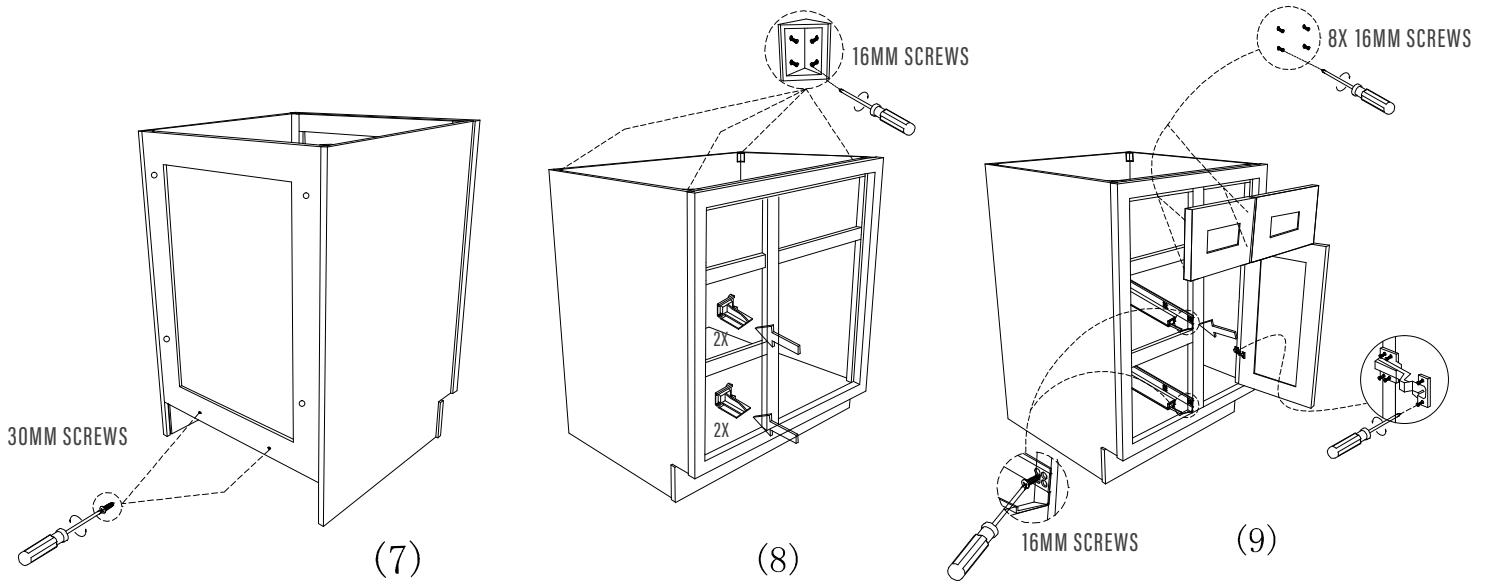

# ASSEMBLY INSTRUCTIONS

## INSET VANITY W/ 2 DRAWERS & 1 DOOR | VSD30(L/R)



ITEM	ITEM CODE	QTY
	J-2	2
	J-3	2
	J-1	2
	J-4	2
	TRACK CLIP	4

