

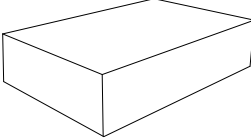









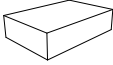





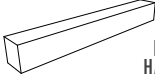

# ASSEMBLY INSTRUCTIONS

## INSET BASE TRASH CAN CABINET | BP18

PACKAGING	ITEM	ITEM CODE	QTY	PACKAGING	ITEM	DESCRIPTION	QTY
		TOOLS REQUIRED: 1. PHILLIPS SCREWDRIVER 2. DRILL		 HARDWARE BOX		CAM LOCK	10
		A-1	1			16MM SCREW	32
		A-2	1			CAM LOCK SCREW	10
		F B	1			30MM SCREW	2
	 DRAWER HARDWARE		C	1		DRAWER TRACK	2
			D	1		REAR TRACK HOLDER	2
			E	1		TRACK CLIPS	2
			J	1			

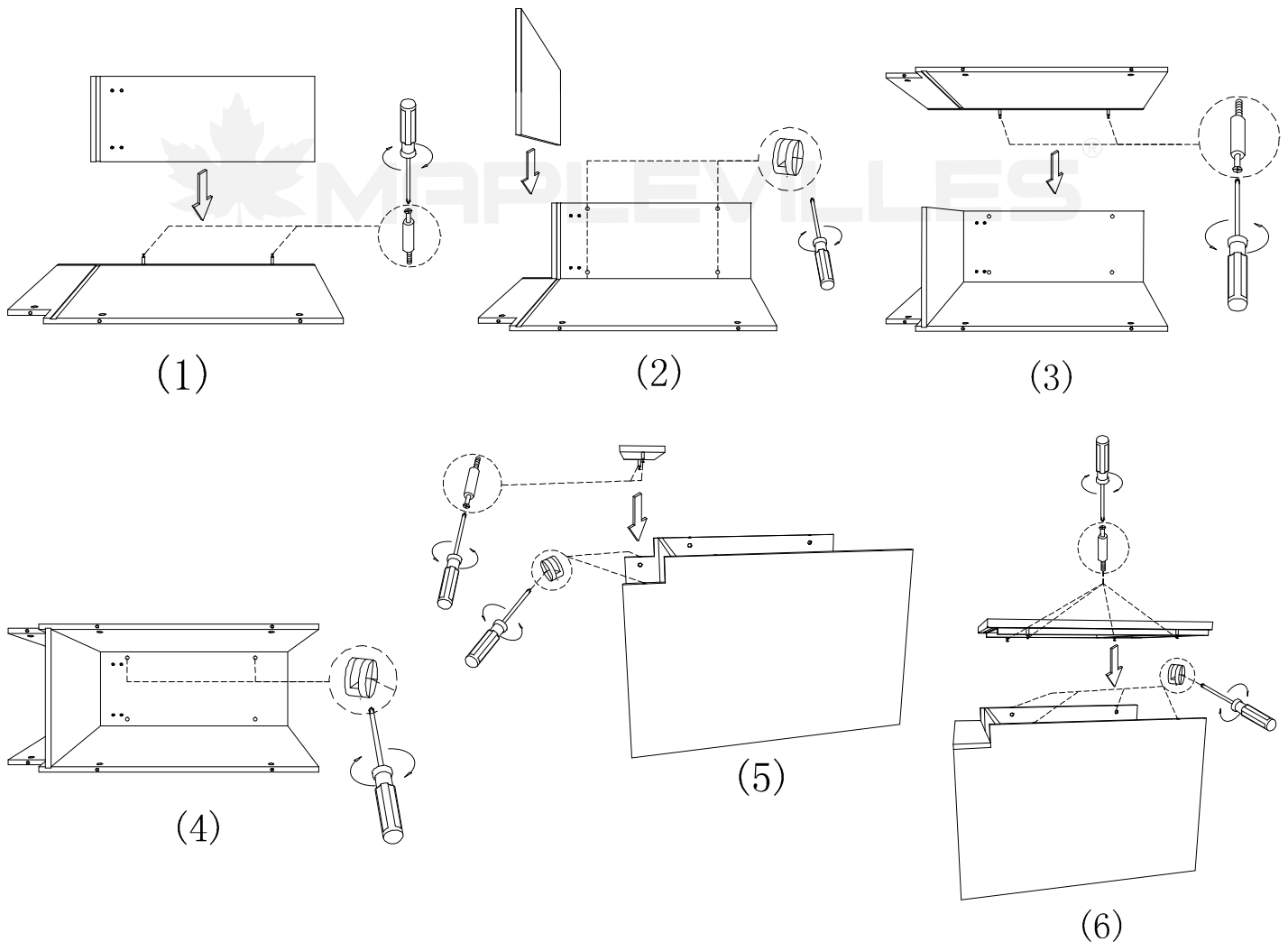

# ASSEMBLY INSTRUCTIONS

## INSET BASE TRASH CAN CABINET | BP18

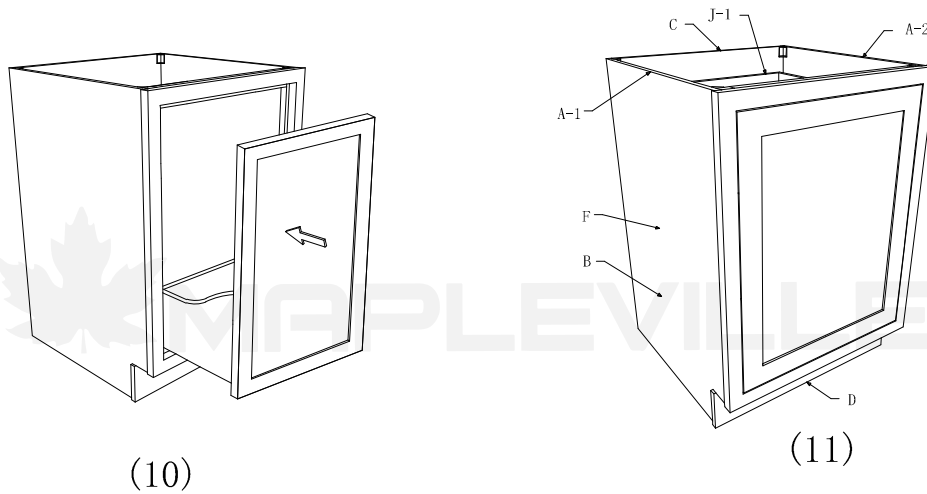
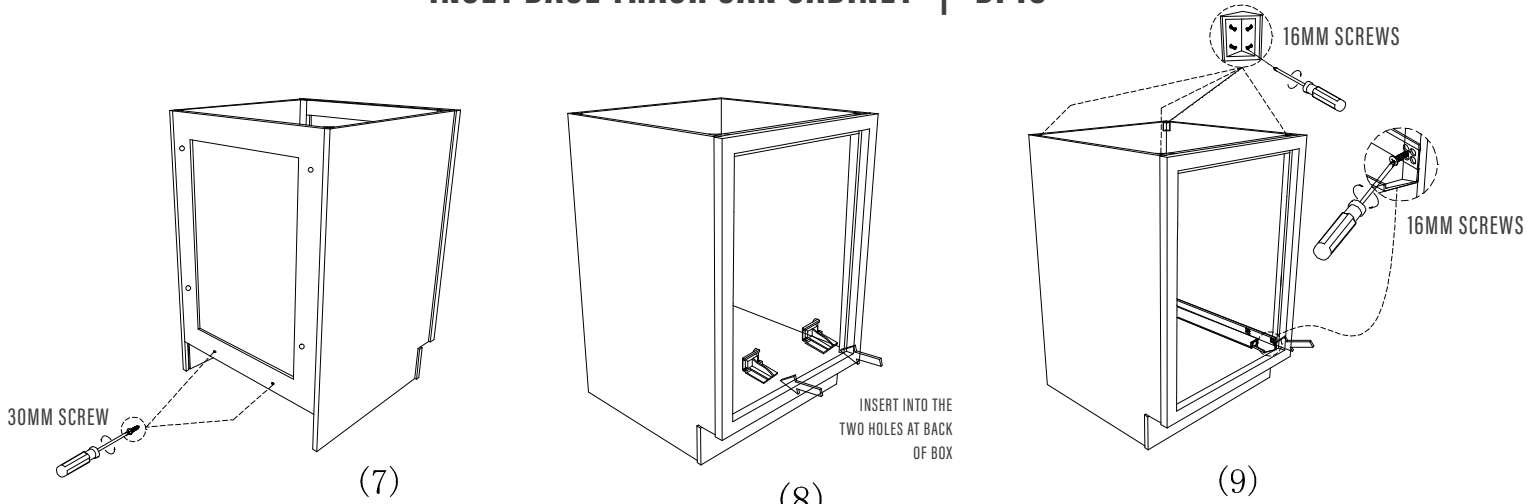

ITEM	ITEM CODE	QTY
	J-2	1
	J-3	1
	J-1	1
	J-4	1
	TRACK CLIP	2

