

382-3386

Summit™ Dual Flush

Elongated Front, Vitreous China, Two-Piece Toilet



Features

- Dual flush technology with 3" flush tower
- 1.1 Gpf / 1.6 Gpf (4.0 Lpf / 6.0 Lpf)
- Elongated front bowl
- SmartFasten™ 3-bolt tank-to-bowl connection
- PuraClean™ easy-to-clean glaze
- Pilot operated anti-siphon fill valve
- 12" rough-in
- Chrome push button actuator
- 2" glazed trapway
- Siphon jet action
- The Mansfield® limited lifetime warranty
- Available in white and standard colors:
biscuit and bone



Elongated Front





Model 382-3386
Toilet seat not included



Also available as a complete toilet kit.*

Components

Model #	Description	Codes/Standards
382-3386	Elongated front, two-piece dual flush toilet. Includes chrome push button actuator. Less toilet seat and supply. Specify color.	  
382	Elongated front toilet bowl only. Less toilet seat. Specify color.	
3386	Tank and cover only with chrome push button actuator. Less supply. Specify color.	
*4382CTK	Elongated front, complete toilet kit. Includes slow close toilet seat, tank and bowl, flange bolts, wax ring with polyethylene flange and instructions.	



MADE IN USA



382-3386

Summit™ Dual Flush

Elongated Front, Vitreous China, Two-Piece Toilet



Specifications

Model #	Description	Codes/Standards
382-3386	Elongated front, (1.1 Gpf / 1.6 Gpf) two-piece dual flush toilet	  

Specification	Description	Specification	Description
Material	Vitreous china	Trap Diameter	2"
Water Pressure Range	20 to 80 PSI	Trap Seal	2-1/2"
Flush System	Dual flush w/3" flush tower	Rough-in	12"
Water Usage	1.1 / 1.6 gpf	Shipping Weight	Model 382 - 50 lbs.
Water Surface Area	10" X 8"		Model 3386 - 38 lbs.
MaP Rating	800 grams	Model 4382CTK - 93 lbs.	
		Warranty	Vitreous China - Limited Lifetime Tank Trim - Limited One Year

Technical Information

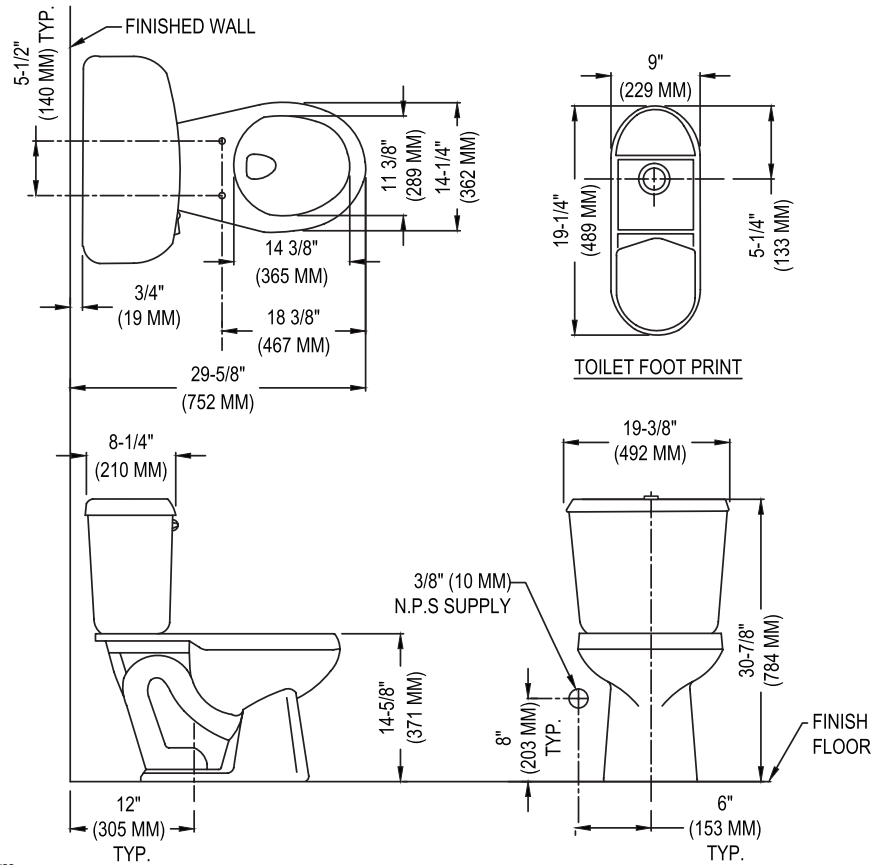

See our complete line of acrylic and vitreous china bathroom fixtures, plastic tank trim and plumbing products.

These dimensions are nominal and subject to change without notice.

Fixture performance and specifications meet or exceed ASME A112.19.2-2008/CSA B45.1-08 standards, and other state and local codes.



MADE IN USA