

135-3125

Alto® 1.28

Elongated Front, Vitreous China, Two-Piece Toilet



Features

- 3 bolt tank-to-bowl connection
- 1.28 gpf / 4.86 lpf low water consumption
- 3" hybrid flush valve
- Elongated front bowl
- Pilot operated fill valve
- 14" Rough-in
- Color-match plastic trip lever
- 2" glazed trapway
- The Mansfield® limited lifetime warranty
- Available in White, Standard Colors: Biscuit, Bone





Elongated Front



Model 135-3125
Toilet seat not included

Components

Model #	Description	Codes/Standards
135-3125	Elongated front, two-piece toilet. Less toilet seat and supply. Specify color.	  
135	Elongated front, toilet bowl only. Less toilet seat. Specify color.	
3125	Tank and cover only, with left hand, color-match, plastic trip lever. Less supply. Specify color.	





135-3125 Alto® 1.28

Elongated Front, Vitreous China, Two-Piece Toilet



Specifications

Model #	Description	Codes/Standards
135-3125	Elongated front (1.28 gpf/4.86 lpf) two-piece toilet	  

Specification	Description	Specification	Description
Material	Vitreous China	Trap Diameter	2"
Water Pressure Range	20 to 80 PSI	Trap Seal	2-1/2"
Flush System	3" hybrid flush valve	Shipping Weight	Model 135 - 50 lbs. (22.6 kg)
Water Usage	1.28 gpf / 4.86 lpf		Model 3125 - 36 lbs. (16.3 kg)
Water Surface Area	9" X 10"	Warranty	Vitreous China - Limited Lifetime
Rough-in	14"		Tank Trim - Limited One Year
MaP	600 grams		

Technical Information

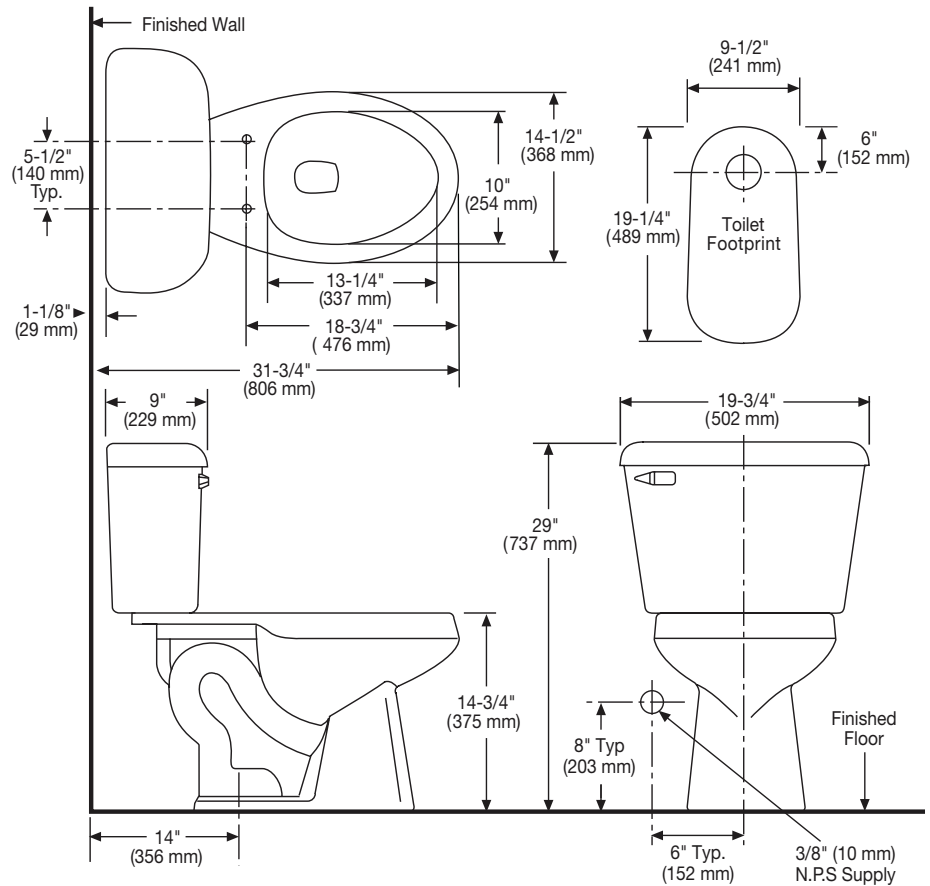

See our complete line of acrylic and vitreous china bathroom fixtures, plastic tank trim and plumbing products.

These dimensions are nominal and subject to change without notice.

Fixture performance and specifications meet or exceed ASME A112.19.2-2008/CSA B45.1-08 standards, and other state and local codes.



MADE IN USA