

1013-1012 Maverick™ 1.0

Round Front, Vitreous China, Two-Piece Toilet



Features

- Uses 38% less water than conventional toilets
- High efficiency 1.0 gpf / 3.8 lpf low water consumption
- Round front bowl
- HET 3" flush valve
- Pilot operated anti-siphon fill valve
- 12" rough-in
- Chrome-plated, metal push button actuator
- 1-7/8" glazed trapway
- The Mansfield® limited lifetime warranty
- Available in White only





Round Front



Model 1013-1012
Toilet seat not included

Components



Model #	Description	Codes/Standards
1013-1012	Round front, two-piece toilet. Includes top metal push button actuator. Less toilet seat and supply.	  
1013	Round front toilet bowl only.	
1012	Tank and cover only, with top metal push button actuator. Less supply.	

1013-1012 Maverick™ 1.0

Round Front, Vitreous China, Two-Piece Toilet



Specifications

Model #	Description	Codes/Standards
1013-1012	Round front (1.0 gpf/3.8 lpf) two-piece toilet	  

Specification	Description	Specification	Description
Material	Vitreous China	Trap Diameter	1-7/8"
Water Pressure Range	20 to 80 PSI	Trap Seal	2-1/4"
Flush System	3" Flush Valve	Rough-in	12"
Water Usage	1.0 gpf / 3.8 lpf	Shipping Weight	Model 1013 - 58 lbs. (26 kg)
Water Surface Area	7-1/4" X 9"		Model 1012 - 34 lbs. (15 kg)
MaP Rating	500 grams	Warranty	Vitreous China - Limited Lifetime Tank Trim - Limited One Year

Technical Information

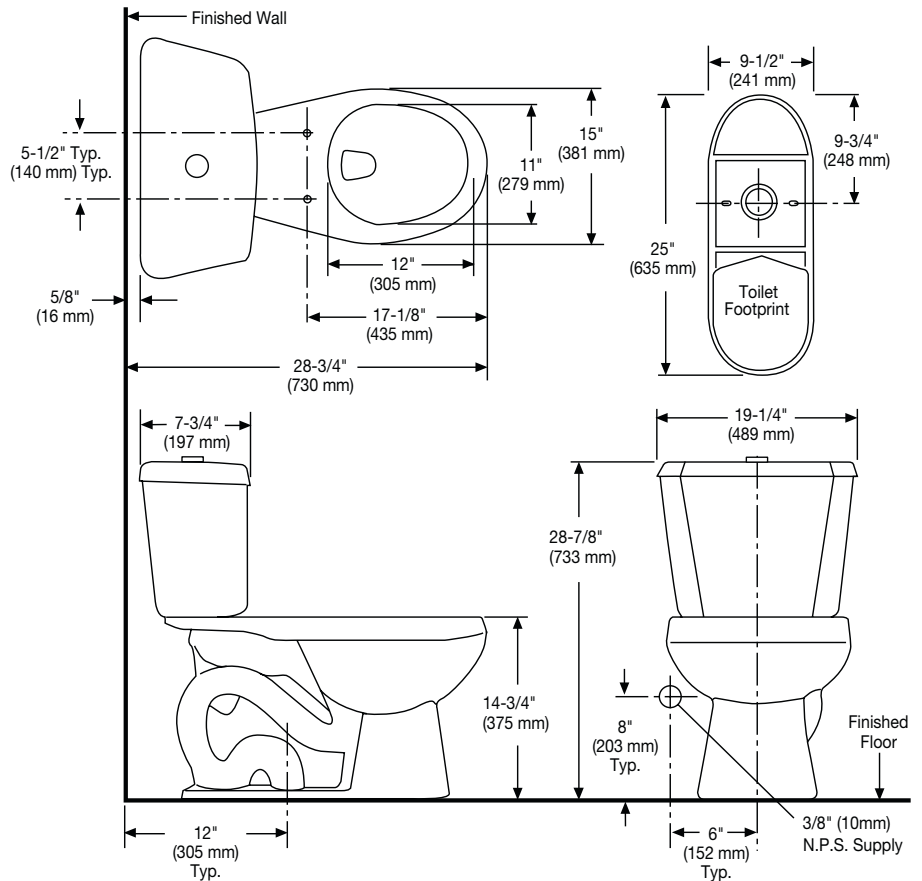

See our complete line of acrylic and vitreous china bathroom fixtures, plastic tank trim and plumbing products.

These dimensions are nominal and subject to change without notice.

Fixture performance and specifications meet or exceed ASME A112.19.2-2008/CSA B45.1-08 standards, and other state and local codes.