

INSTALLATION INSTRUCTIONS FOR OUTDOOR CHAPTER FIXTURE

7554 7557 7660 7669 7710 7711 7789

WARNING! SHUT POWER OFF AT FUSE OR CIRCUIT BREAKER .

ASSEMBLING THE FIXTURE (Fig.1).

***Shut off the power at the circuit breaker and remove old fixture, including the old small hardware.**

- Carefully unpack new fixture and lay all the parts on a clear surface. Take care not to lose any small parts necessary for installation.
- Install the light bulbs in accordance with the fixture specifications
NOTE: DO NOT EXCEED THE SPECIFIED WATTAGE!
- Thread nipple of the finial(A) into cover (B) and lock it securely with the hex nut(D).
- Attach the cover(B) onto the fixture body(E) aligning the holes on it and lock it securely with hex nut(C).
- Screw the pole(F),(G) together tightly. **Follow wiring instructions carefully (see fig.2).**
- Put the pole(I) onto the concrete base using the mounting knob(J).
 - The depth of the base will depend on local soil conditions and frost line. The diameter of the base should be 305mm in order to hold the anchor bolts on the plate.
 - Take the three bolts(L) and run a hex nut(M) fully down each part of the threaded section. Insert the bolt(L) to the template(K) and secure with the second hex nuts.
 - Mix and pour the concrete into the former until it reaches the top. Push the assembly into concrete until the plate are 0.25 inches above the concrete .Leaving 2.5 inches of the thread above the concrete.
 - It is important to level the template before the concrete sets.
- Install the fixture together with the pole(F),(G) onto the pole(I), secure them using the machine screws(H).

CONNECTING THE WIRES (Fig.2)

***Feed the fixture wires through the pole(F),(G) .**

- Take the black wire(hot) from the outlet box and the black wire of fixture and twist bare ends together. Twist wire connector onto end of wire until snug.
- Repeat same process with white wire(neutral) from outlet box and white wire of fixture. NOTE: Twist wires together in the same direction you twist the wire connector onto wires.
- If your outlet box has a grounding wire (green or bare copper), attach this wire and the bare copper wire from the fixture together as step 1. If junction box has no ground wire, attach the bare copper fixture wire to the green ground screw in the bottom of the pole(I).
- Tuck the wire connections neatly into the pole. Take the fixture(E) mount onto the pole(F) .

Your installation is now complete. Return power to the junction box and test the fixture.

Fig.1

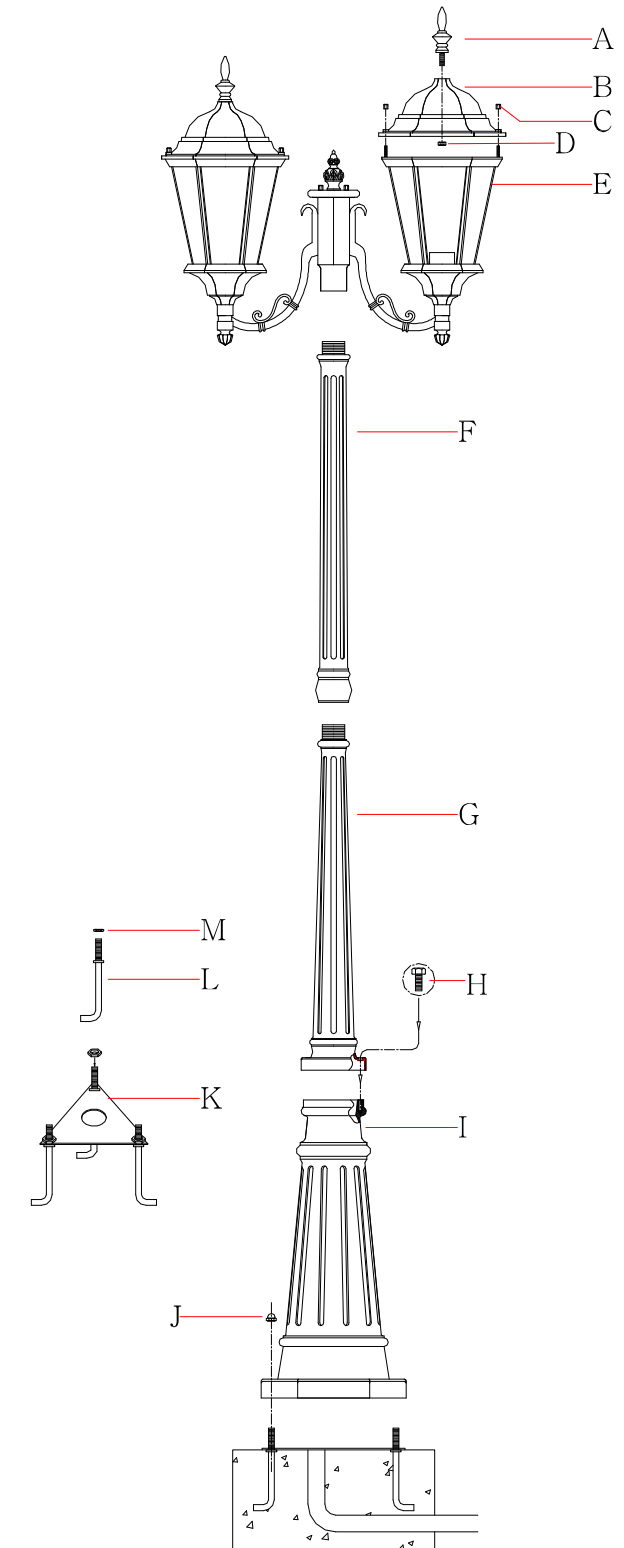



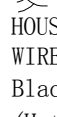
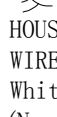
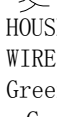

Fig.2

FIXTURE WIRES		FIXTURE WIRES		FIXTURE WIRES	
Black or Smooth		White or Ribbed		Bare Copper (Ground)	
HOUSE WIRES		HOUSE WIRES		HOUSE WIRES	
Black (Hot)		White (Neutral)		Green or Bare Copper (Ground)	

UL
Listed

Livex Lighting