

DIGITAL NAVIGATION

[Ordering Tree](#) [Sensor Switch AIR](#) [nLight Platform](#) [Performance Data](#) [Photometrics](#)

FEATURES & SPECIFICATIONS

INTENDED USE — Available in several color temperatures, lumen packages and lengths. Ideal for use in commercial, retail, office, warehouse and display applications. **Certain airborne contaminants can diminish integrity of polycarbonate.**

Certain airborne contaminants may adversely affect the functioning of LEDs and other electronic components, depending on various factors such as concentrations of the contaminants, ventilation, and temperature at the end-user location. [Click here for a list of substances that may not be suitable for interaction with LEDs and other electronic components.](#)

CONSTRUCTION — Compact-design channel and cover are formed from code compliant, 22 gauge cold-rolled steel.

FINISH — High-gloss, baked white enamel (standard).

OPTICS — LEDs provide 80+ color rendering index (CRI) at 3500K, 4000K and 5000K. Diffuse polycarbonate lens with ultra-sonically welded end caps provides smooth, linear illumination.

ELECTRICAL — Luminaire Surge Protection Level: Designed to withstand up to 2.5kV/0.75kA per ANSI C82.77-5-2015. For applications requiring higher level of protection additional surge protection must be provided.

Driver is standard 0-10V dimming class 2.

Optional internal pluggable wiring harness for reduced labor cost in row mounting applications. See PLR_ordering information on page 6.)

CONTROLS — **Networked Embedded Controls** — CSS is available with (wired or wireless) networked embedded controls by nLight®, addressing requirements of Luminaire Level Lighting Controls (LLLC). A wired nLight or wireless nLight AIR (sensor and/or control device) can be embedded within this luminaire.

CONTROLS — **Standalone Embedded Controls** — CSS is available with (wired or wireless) standalone embedded controls by SensorSwitch. A wired SensorSwitch or wireless SensorSwitch AIR (sensor and/or control device) can be embedded within this luminaire.

INSTALLATION — Fixture may be surface mounted to a ceiling or horizontal and vertical wall or suspension mounted with appropriate mounting options (see accessories). Easy to install row aligner bracket included for continuous row mounting.

LISTINGS — CSA certified to US and Canadian safety standards and listed suitable for damp locations. Minimum starting temperature of -22°F (-30°C). Standard maximum ambient operating temperature of 113°F (40°C) for 4ft models and 95°F (35°C) for 2ft & 8ft models. See page 13 for complete ambient operating chart.

DesignLights Consortium® (DLC) Premium qualified product and DLC qualified product. Not all versions of this product may be DLC Premium qualified or DLC qualified. Please check the DLC Qualified Products List at www.designlights.org/QPL to confirm which versions are qualified.

Suitable for use within closet spaces when installed per NEC 410.16 spacing requirements.

GOVERNMENT PROCUREMENT — BAA – Buy American Act: This product is available in a version that qualifies as a domestic end product under the Buy American Act as implemented in the FAR and DFARS.

BABA – Build America Buy America: This product is available in a version that qualifies as produced in the United States under the definitions of the Build America, Buy America Act, as implemented by 2 C.F.R. Part 184 and other agency implementing regulations, including Department of Transportation regulations.

Please refer to www.acuitybrands.com/resources/buy-american for additional information.

WARRANTY — 5-year limited warranty. This is the only warranty provided and no other statements in this specification sheet create any warranty of any kind. All other express and implied warranties are disclaimed. Complete warranty terms located at: www.acuitybrands.com/support/warranty/terms-and-conditions

Note: Actual performance may differ as a result of end-user environment and application. All values are design or typical values, measured under laboratory conditions at 25 °C. Specifications subject to change without notice.

Catalog Number
Notes
Type

LED Strip Light

CSS

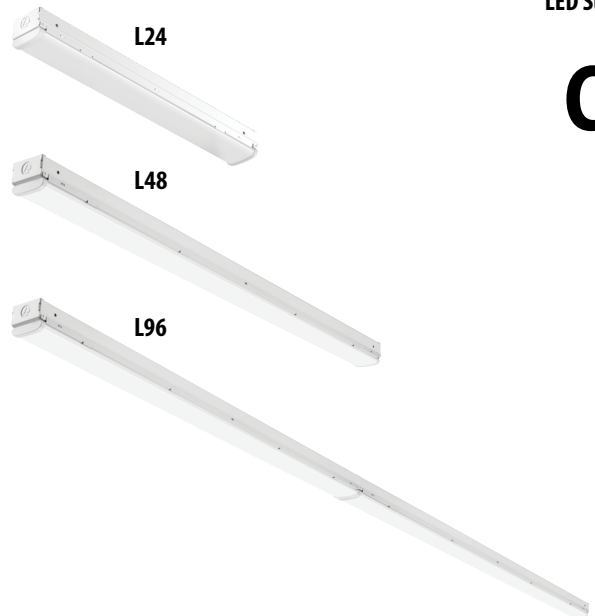

A+ Capable Luminaire

This item is an A+ capable luminaire, which has been designed and tested to provide consistent color appearance and out-of-the-box control compatibility with simple commissioning when used with Acuity Brands controls products. *All configurations of this luminaire are calibrated and tested to meet the Acuity Brands' specifications for chromatic consistency – including color rendering, color fidelity, and color temperature tolerance around standard CIE chromaticity coordinates.*

To learn more about Acuity A+ standards, specifications, and testing visit www.acuitybrands.com/aplus.



Items marked by a shaded background qualify for the Design Select program and ship in 15 days or less. To learn more about Design Select, visit www.acuitybrands.com/designselect. *See ordering tree for details

CSS LED Strip Light

CS Looking for Contractor Select readily available configurations? [Click here](#) to visit Contractor Select™ spec sheet or go to www.contractorselect.com

ds Design Select options indicated by this color background.

ORDERING INFORMATION Lead times will vary depending on options selected. Consult with your sales representative. **Example:** CSS L48 5000LM MVOLT MIN10 ZT 40K 80CRI

Series	Nominal Length	Lumen Output	Voltage	Min Dim Level	Dimming
CSS Contractor Single Strip LED	L24 ‡ 22"	1500LM 1500 Lumens 2000LM 2000 Lumens 2500LM 2500 Lumens AL015 Switchable lumens, 1500LM / 2000LM / 2500LM ‡	MVOLT 120-277V UVOLT 120-347V ‡ 120/277 120/277V* 347 347V ‡	MIN10 Dims to 10% MIN1 Dims to 1% ‡	ZT LED Driver 0-10V ‡ ZC LED Driver compatible w/Controls ‡ EZC eldoLED LED Driver compatible w/Controls ‡
	L48 48"	3000LM 3000 Lumens 4000LM 4000 Lumens 5000LM 5000 Lumens 6000LM 6000 Lumens 7000LM 7000 Lumens ALO3 Switchable lumens, 3000LM / 4000LM / 5000LM ‡	* 120/277 is only available with SSE PIR and required for SSE PIR.		
	L96 96"	6000LM 6000 Lumens 8000LM 8000 Lumens 10000LM 10000 Lumens 12000LM 12000 Lumens 14000LM 14000 Lumens ALO4 Switchable lumens, 6000LM / 8000LM / 10000LM ‡			

Color temperature	Color rendering index	Emergency Option	Plug-In Wiring Option	Finish
30K 3000K 35K 3500K 40K 4000K 50K 5000K SWW3 Switchable white, 35K / 40K / 50K ‡	80CRI 80 CRI	(blank) no battery E7W 7W Emergency battery pack, constant power, Certified in CA Title 20 MAEDBS, User selectable Self-Diagnostic, AC Activate with Integral Test Switch (LINK) ‡ E10W 10W Emergency battery pack, constant power, Certified in CA Title 20 MAEDBS, User selectable Self-Diagnostic, AC Activate with Integral Test Switch (LINK) ‡ GTD Generator Transfer device ‡	(blank) no wiring PLR___ Plug-in wiring ‡ PLR1LVG Plug-in wiring, low voltage dimming ‡	(blank) Matte White, fixture finish MB Matte Black, fixture finish DNA Natural Aluminum, fixture finish

* See field installable battery options on page 6.

NOTE: ‡ indicates option chosen has ordering restrictions. Please reference ordering restrictions chart.

See controls option, accessories and ordering restrictions chart next page.

Controls Option			
Control Input		Sensor	
SSE	Sensor Switch Embedded ‡	PIR APIR APDT VPIR VAPIR	Factory installed On/Off motion sensor, 360° small motion ‡ Occ sensing with passive infrared - on/off functionality and auto dimming photocell Occ sensor dual tech (passive infrared & microphonics) and auto dimming photocell ‡ Vertex low-profile on/off occupancy PIR occupancy sensor with VLP programming at 15ft mounting height Vertex low-profile on/off occupancy sensor with auto dimming photocell with VLP programming at 15ft mounting height ‡
SSAIR	Sensor Switch Air	(blank) VAPIR	No Sensor or Control Input function only, if selected. Vertex low-profile on/off occupancy sensor with auto dimming photocell with VLP programming at 15ft mounting height ‡
NLIGHT NLIGHTER NLIGHTLM NLIGHTERLM	nLight enabled nLight enabled, for use with generator supply EM power nLight enabled with lumen management nLight enabled with lumen management, for use with generator supply EM power	(blank) PIR PDT APIR APDT	No sensor, Control Input function only Occ sensing with passive infrared - on/off functionality Occ sensor dual tech (passive infrared & microphonics) Occ sensing with passive infrared - on/off functionality and auto dimming photocell Occ sensor dual tech (passive infrared & microphonics) and auto dimming photocell
NLTAIR2 NLTAIREM2	nLight AIR Generation 2 (wireless) enabled nLight AIR Generation 2 (wireless) enabled and UL924 Emergency Operation, via power interrupt detection	(blank) APIR APDT VPIR	No sensor, Control Input function only Occ sensing with passive infrared - on/off functionality and auto dimming photocell Occ sensor dual tech (passive infrared & microphonics) and auto dimming photocell Vertex low-profile on/off occupancy PIR occupancy sensor with VLP programming at 15ft mounting height ‡

NOTE: ‡ indicates option chosen has ordering restrictions. Please reference ordering restrictions chart.

Switchable White & Adjustable Lumen Output – BAA Compliant:
CSS L48 ALO3 MVOLT MIN10 ZT SWW3 80CRI BAA CSS L96 ALO4 MVOLT MIN10 ZT SWW3 80CRI BAA CSS L96 ALO4 120/277 MIN10 ZT SWW3 80CRI SSE PIR BAA CSS L48 ALO3 MVOLT MIN10 ZT SWW3 80CRI E7W BAA CSS L48 ALO3 MVOLT MIN10 ZT SWW3 80CRI E10W BAA CSS L96 ALO4 MVOLT MIN10 ZT SWW3 80CRI E10W BAA CSS L48 ALO3 120/277 MIN10 ZT SWW3 80CRI E10W SSE PIR BAA CSS L96 ALO4 120/277 MIN10 ZT SWW3 80CRI E10W SSE PIR BAA

Accessories: Order as separate catalog number.		
Part Number	CI Code	Description
HC36 M12	*408275	Hanger chain, 36" (1 pair)
ZACVH M100	*209F4T	Adjustable 10' aircraft cable with Y hanger (1 pair)
rPP20D		nLight® air dimming/switching module
SFR7CSS	*266MA8	SSE PIR 120/277V field installed On/Off motion sensor, 360° small motion ‡
SFR7CSS 347	*290EM8	SSE PIR 347V field installed On/Off motion sensor, 360° small motion ‡
Y J10	*216289	Y hanger in multiples of 10 (five pair)
WGCSS	*2673N9	Wire Guard with Mounting hardware (one 4ft) ‡
MNLK JBOXCVR M12	*225TT9	Junction box cover and hardware, white
SQ_		Swivel stem hanger (specify length in 2" increments up to 48")
CSSTGRIDBRKT 15/16 INCH	*295RNE	T Grid bracket, 15/16 INCH
CSSTGRIDBRKT 9/16 INCH	*295RNX	T Grid bracket, 9/16 INCH
CSSTGRIDBRKT 1.56 INCH	*295RPO	T Grid bracket, 1.56 INCH
CSSTGRIDBRKT 1.67 INCH	*295RPA	T Grid bracket, 1.67 INCH
CSSTGRIDBRKT 2 INCH	*295RPC	T Grid bracket, 2 INCH
CSSTGRIDBRKT 2.76 INCH	*295RPH	T Grid bracket, 2.76 INCH
CSSANGBRKTWH	*295RN2	Angle bracket, White finish
CSSANGBRKTDNA	*295RN6	Angle bracket, Natural Aluminum finish
CSSANGBRKTMB	*295RNA	Angle bracket, Matte Black

‡ Option Value Ordering Restrictions	
Option value	Restriction
L24	Not available with GTD, any emergency battery, and or 347V with ZC or EZC. Not available with 30K CCT.
ALO15, ALO3, ALO4, SWW3	Not available with static lumen packages or 30K, 35K, 40K, or 50K. Not available with controls except SSE PIR. Only available with ZT. Switchable fixtures ship standard on middle lumen and CCT setting.
MIN 1	Must be used for ZC or EZC.
E7W, E10W	Not available with L24. Not available with L48 7000LM with NLIGHT controls. Not available with PLR options. Not available with 347V or UVOLT. Not available with GTD.
GTD	Requires MVOLT, not available with any emergency battery.
VPIR and VAPIR	Requires EZC. Not available with GTD or UVOLT. See page 5 for default programming and coverage pattern information.
SSE PIR/ SFR7CSS/ SFR7CSS 347	Can only be mounted at the end of continuous row mount applications. On/off function only. Ensure correct sensor voltage. See page 7 for coverage pattern. Voltage specific, must choose 120/277 or 347. Not available with MB or DNA. Only available with MIN10 ZT.
WGCSS	Does not cover SFR controls. Not recommended for use with endcap integrated SSAIR or VLP enabled controls due to potential detection obstruction.
PLR_	PLRxlVVG not available with any controls. L24 ONLY AVAILABLE WITH PLR1G AND PLR1LVG. Not available with any emergency or GTD.
UVOLT	Not available with Emergency or controls. Only available with MIN10 and ZT.
NLIGHT, NLIGHTER, NLIGHTLM, and NLIGHTERLM	Not available with PLR, PLR__LVG. Not available with L48 7000LM ZC or EZC.
NLTAIR2, NLTAIREM2	Not available with UVOLT. Not available with PLR, PLR__LVG.
ZC	Requires MIN1 dimming. Control required, not available with VPIR, VAPIR, or SSAIR, SSE PIR and UVOLT.
EZC	Requires MIN1 dimming. Control required, not available with SSE PIR and UVOLT.
ZT	Requires MIN10 dimming. Not available with controls except SSE PIR.
120/277V	Only available with SSE PIR.
347V	Not available with UVOLT, any emergency or GTD.

Intelligent Luminaire Technology Guide

Choose nomenclature from these columns							
Control/Sensor Configurations	Control Input		Sensor	Sensor	Previous Nomenclature		
		SSE	+	APIR	=	MSD 7 ADCX	MSD7ADCX
		SSE	+	APDT	=	MSD PDT 7 ADCX	MSDPDT7ADCX
		SSE	+	VPIR	=	VERTEX EZ OCC VLP	VTX15FOCC
		SSE		VAPIR	=	VERTEX EZ ADC VLP	VTX15FADC
		SSAIR		(blank)		BTRM SSA BTA	JOT
		SSAIR	+	VAPIR	=	BTRM SSA BTA + VERTEX	JOTVTX15
		NLIGHT		(blank)		nIO	NLIGHT
		NLIGHT	+	PIR	=	nIO + nES 7	NLIGHT NES7
		NLIGHT	+	PDT	=	nIO + nES PDT 7	NLIGHT NESPDT7
		NLIGHT	+	APIR	=	nIO + nES 7 ADCX	NLIGHT NES7ADCX
		NLIGHT	+	APDT	=	nIO + nES PDT 7 ADCX	NLIGHT NESPDT7ADCX
		NLIGHTER	+	(blank)	=	nIO ER	NLIGHT EMG
		NLIGHTER	+	PIR	=	nIO ER + nES 7	NLIGHT EMG NESPDT7
		NLIGHTER	+	PDT	=	nIO ER + nES PDT 7	NLIGHT EMG NES7ADC
		NLIGHTER	+	APIR	=	nIO ER + nES 7 ADCX	NLIGHT EMG NES7ADCX
		NLIGHTER	+	APDT	=	nIO ER + nES PDT 7 ADCX	NLIGHT EMG NESPDT7ADCX
		NLIGHTLM	+	(blank)	=	nIO N80	NLIGHT CL80
		NLIGHTLM	+	PIR	=	nIO N80 + nES 7	NLIGHT CL80 NES7
		NLIGHTLM	+	PDT	=	nIO N80 + nES PDT 7	NLIGHT CL80 NESPDT7
		NLIGHTLM	+	APIR	=	nIO N80 + nES 7 ADCX	NLIGHT CL80 NES7ADCX
		NLIGHTLM	+	APDT	=	nIO N80 + nES PDT 7 ADCX	NLIGHT CL80 NESPDT7ADCX
		NLIGHTLERLM	+	(blank)	=	nIO ER N80	NLIGHT EMG CL80
		NLIGHTLERLM	+	PIR	=	nIO ER N80 + nES 7	NLIGHT EMG CL80 NES7
		NLIGHTLERLM	+	PDT	=	nIO ER N80 + nES PDT 7	NLIGHT EMG CL80 NESPDT7
		NLIGHTLERLM	+	APIR	=	nIO ER N80 + nES 7 ADCX	NLIGHT EMG CL80 NES7ADCX
		NLIGHTLERLM	+	APDT	=	nIO ER N80 + nES PDT 7 ADCX	NLIGHT EMG CL80 NESPDT7ADCX
		NLTAIR2	+	(blank)	=	RIO	NLTAIR2 RIO
	NLTAIR2		APDT		RES7 PDT	NLTAIR2 RES7PDT	
	NLTAIR2	+	APIR	=	RES7	NLTAIR2 RES7	
	NLTAIR2	+	APIR	=	RES7	NLTAIR2 RES7	
	NLTAIR2	+	VPIR	=	RIO + VERTEX	NLTAIR2 VTX15FOCC	
	NLTAIREM2	+	(blank)	=	RIO EM	NLTAIR2 RIOEM	
	NLTAIREM2	+	APDT	=	RES7 PDT EM	NLTAIR2 RES7PDTEM	
	NLTAIREM2	+	APIR	=	RES7 EM	NLTAIR2 RES7EM	
	NLTAIREM2	+	VPIR	=	RIO + VERTEX	NLTAIR2 VTX15FOCC	

OPTIONS AND ACCESSORIES

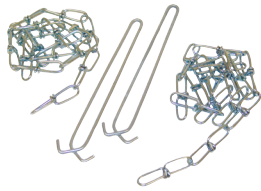

HANGER CHAIN
36" chain with Y hanger. ships as a pair
Order as:
HC36



ZACVH HANGER
10' Aircraft cable with Y hanger.
Order as:
ZACVH

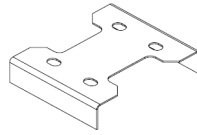

ROW ALIGNER
Bracket for continuous row
mount and 4 screws
Included in box

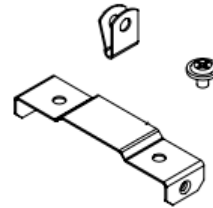

WIRE GUARD MOUNTING BRACKET
Mounting hardware included
Order as:
WGCSS

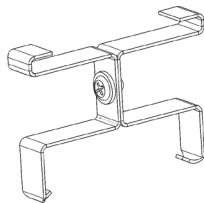

T GRID BRACKET
Ships as pair
Order as:
CSSTGRIDBRKT_

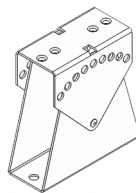

ANGLE BRACKET
Ships as pair
Order as:
CSSANGBRKT_

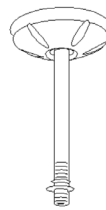

SQ SWIVEL HANGER
Swivel stem hanger (specify length
in 2" increments up to 48")
Order as:
SQ_

Emergency Battery Pack Options - Field Installable

Battery Model Number	Wattage	Runtime (Minutes)	Lumen Output* @ 120 Lumens/Watt	Voltage	Other
ILB CP07 2H A	7W	120	840	MVOLT (120-277V) HVOLT (347V-480V)	Storm Shelter / 2 Hour Runtime
ILB CP10 A	10W	90	1200	MVOLT (120-277V) HVOLT (347V-480V)	
ILBLP CP10 HE SD A	10W	90	1200	MVOLT (120-277V) HVOLT (347V-480V)	Title 20, Self Diagnostic
ILB CP10 HE AELR A	10W	90	1200	MVOLT (120-277V) HVOLT (347V-480V)	Title 20; Enabled with Self Testing, Automated Reporting (STAR)
ILBHI CP10 HE SD A	10W	90	1200	MVOLT (120-277V) HVOLT (347V-480V)	347-480V operation, Self Diagnostic
ILBLP CP15 HE SD A	15W	90	1800	MVOLT (120-277V) HVOLT (347V-480V)	Title 20, Self Diagnostic
ILB CP20 HE A	20W	90	2400	MVOLT (120-277V) HVOLT (347V-480V)	Title 20
ILB CP20 HE SD A	20W	90	2400	MVOLT (120-277V) HVOLT (347V-480V)	Title 20, Self Diagnostic



Emergency Battery Delivered Lumens
 Use the formula below to determine the delivered lumens in emergency mode
Delivered Lumens = P x LPW
P = Output power of emergency driver (10W for E10W or 7W for E7W)
LPW = Lumen per watt rating of the luminaire can be found in Performance section on this spec sheet

All the above are UL Listed products that are certified for field install external/remote to the fixture.
 *Minimum delivered lumen output to assist in product selection for increased fixture mounting height.
 The CP10 delivered emergency illumination outperforms legacy 1400 lumen fluorescent emergency ballast.
 ILBHI CP10 HE SD A High voltage emergency driver (347-480V). For use with UVOLT fixtures ONLY at 347V operation.
 Please contact us at techsupport@iotaengineering.com for any Emergency Battery related questions.

Enabled with STAR

Emergency Lighting with Self-Testing Automated Reporting (STAR), enables self-testing and automated reporting to aid in life safety code compliance. Build your solution and choose your preferred deployment from Mobile STAR, where test data is logged in each individual unit and broadcast to the CIAIRity™+ app, or Connected STAR, where test data is logged in the STAR Gateway by IOTA® and emailed directly.
Leave the ladders, disruptions and written records behind with emergency lighting solutions with STAR!

Life Safety Code NFPA 101 testing and reporting requirements for emergency lighting include:

-  Testing for 30 seconds every 30 days
-  Testing for 90 minutes once a year
-  Record keeping and to report to the authority having local jurisdiction

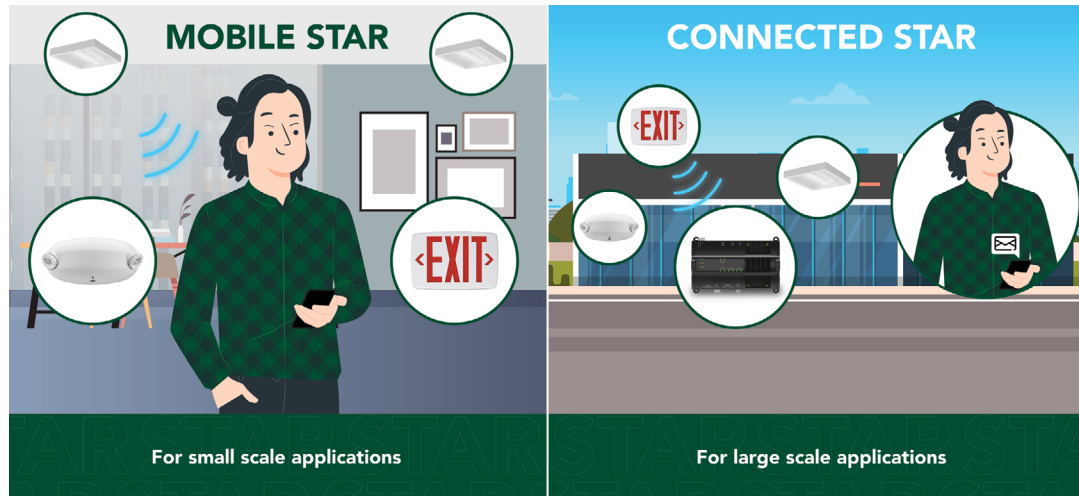

PLUG-IN WIRING OPTION

Advanced plug-in system with two-circuit capability. Available on industrial and strip products and a variety of architectural products mounted in continuous rows. PLR22 (2-circuit) and crossover harness switches hot circuit serving next fixture in row. Reduces fixture types on job for alternating circuit applications (see example below.)

Easy one-step installation, saves up to 35% on labor costs. Expanded switching flexibility helps save energy.

Rows can be 50% longer with two-circuit systems. Polarized, lock-together nylon connectors prevent miswiring in the field. #12 THHN conductor, rated 600V, 90°C. White neutral wire included. Grounding accomplished by fixture in-row connectors.

CSA certified systems available with up to 2 circuits. G ground required.

Not for use with dedicated emergency circuits.

Note: Specifications subject to change without notice.



PLR

Advanced 1 or 2-Circuit Plug-In

ORDERING INFORMATION Lead times will vary depending on options selected. Consult with your sales representative.

Series	Number of hot wires		Branch circuits	Dimming	Ground
PLR	(blank)	Not required for PLR22	<u>Circuits to which driver is connected</u>	LV Low-voltage dimming	G Ground (required)
PLR22	1	Black	(blank) Not required for PLR22		
	2	Black and red	A Black wire		
			B Red wire		

Typical Applications

- Multiple-circuit and single-circuit for longer continuous rows
- Multiple-circuit with alternating fixtures on separate circuits and 2-circuit (PLR22)
- Multiple circuit with night-lights located along row as desired



Performance You Can Count On

SensorSwitch™ offers standalone wired and wireless lighting controls solutions designed for room-based applications. Our products offer reliable performance and ease of installation.

Sensorswitch.com

Wired Embedded Controls

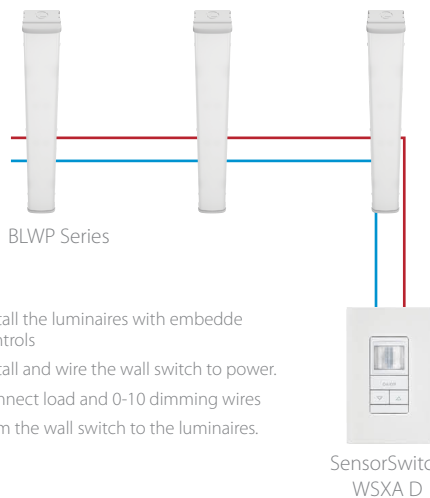

Wireless Embedded Controls





Single Lighting Controls Platform for Indoor & Outdoor Spaces

nLIGHT® is your networked lighting controls platform, for indoor and outdoor applications, providing wired or wireless options. Scaling from room to campus-wide applications, it is the one platform that grows with your business today and tomorrow; to seamlessly address energy cost optimization, building code compliance, improved occupant comfort, and much more.

nLIGHT also interfaces with DALI®, BACnet®, DMX and additional third-party devices.

nLIGHTcontrols.com

Wired Embedded Controls

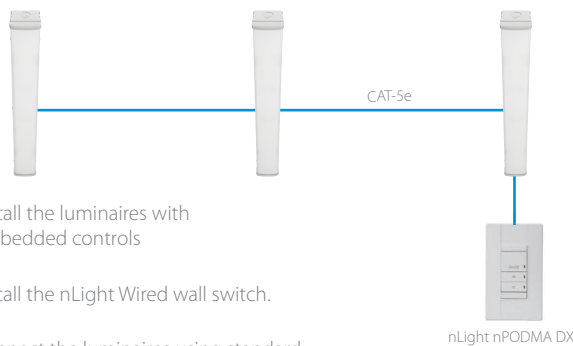

1. Install the luminaires with embedded controls
2. Install the nLight Wired wall switch.
3. Connect the luminaires using standard CAT-5e cables and the controls devices will automatically discover each other and work (plug and play).

Wireless Embedded Controls



1. Install the luminaires with embedded controls
2. Install the nLight AIR battery-powered wall switch
3. Use **CLAIRITY** + mobile app to pair the fixture with the wall switch and if desired, customize the sensor settings

SENSOR COVERAGE PATTERNS

15F LARGE MOTION EXTENDED RANGE 360°

- Optimized full coverage from 8 ft - 15 ft (2.4 m - 4.5 m) mounting heights
- Reliable detection of large motion (e.g. pedestrian walking traffic)
- 1.3 x's mounting height equals approximate detection range



TOP VIEW

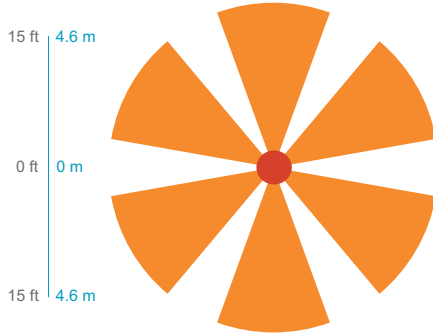

SIDE VIEW

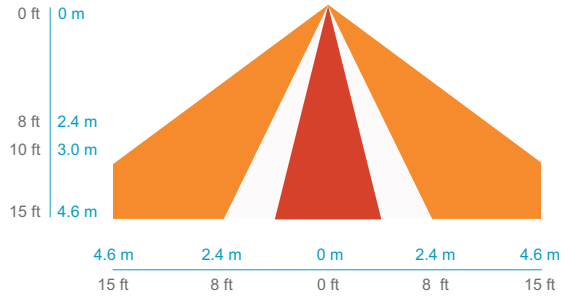

SSE PIR SENSOR COVERAGE PATTERNS

PIR MINI LOW BAY 360°

- Recommended for walking motion detection from mounting heights between 8 ft (2.44 m) and 20 ft (6.10 m)
- Initial detection of walking motion along sensor axes at distances of 2x the mounting height up to 15 ft (4.57 m) and 1.75x up to 20 ft (6.10 m).
- Provides 12 ft (3.66 m) radial detection of small motion when mounted at 9 ft (2.74 m)
- Initial detection will occur earlier when walking across sensor's field of view than when walking directly at sensor



9 FT MOUNTING

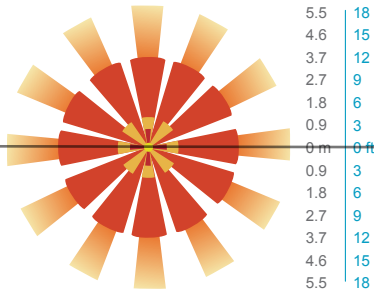

15 FT MOUNTING

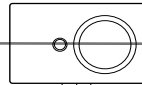
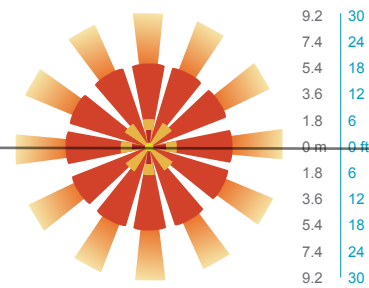

Note: Align sensor axes along aisleway for best detection results

MAXIMUM # OF FIXTURES PER SFR SENSOR

Nomenclature	Maximum # of Fixtures per SSE PIR SENSOR
CSS L48 4000LM MVOLT	20
CSS L48 AL03 MVOLT	16
CSS L96 8000LM MVOLT	10
CSS L96 AL04 MVOLT	8

*PLR option recommended for continuous row mounting with SSE PIR sensor. Input power for continuous row must come through end-of-row fixture with sensor. SSE PIR sensor operates On/Off only.

DIMENSIONS

All dimensions are shown in inches unless otherwise noted.

Nominal Length	Length	Width	Height	Approximate weight	Fixtures per pallet	Pallet Dimensions
L24	22"	2.62	2.22	2.5 lbs	336	40 x 48
L48	48"	2.62	2.22	5 lbs	135	46 x 57
L96	96"	2.62	2.22	10 lbs	102	46 x 98.5

*Weights will vary slightly with added options.

2FT Assembly

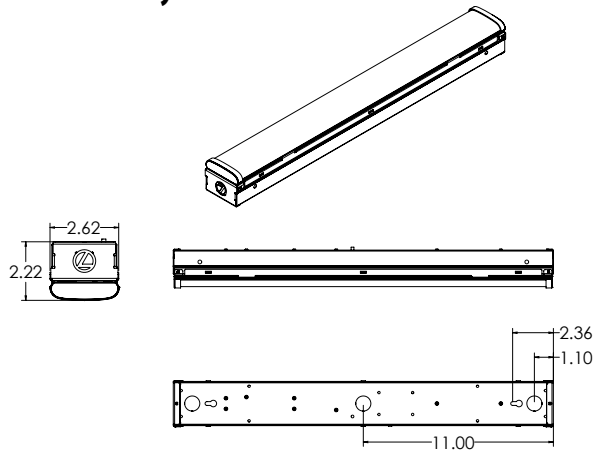

4FT Assembly

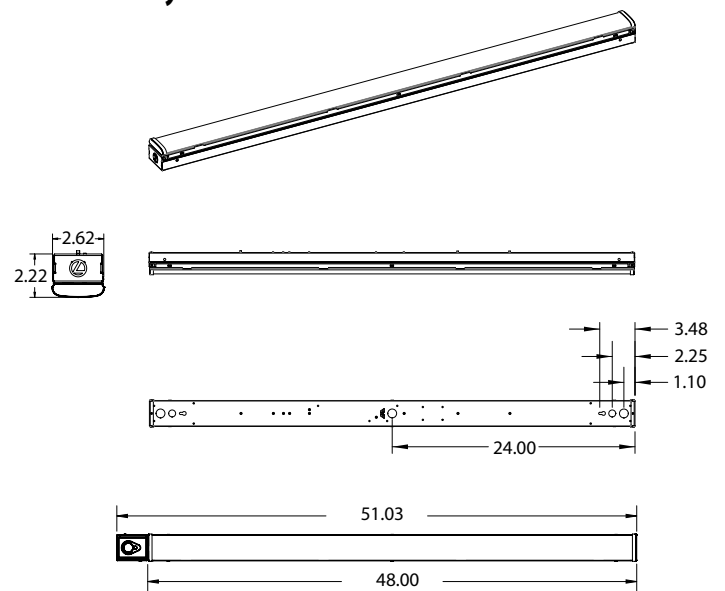

8FT Assembly

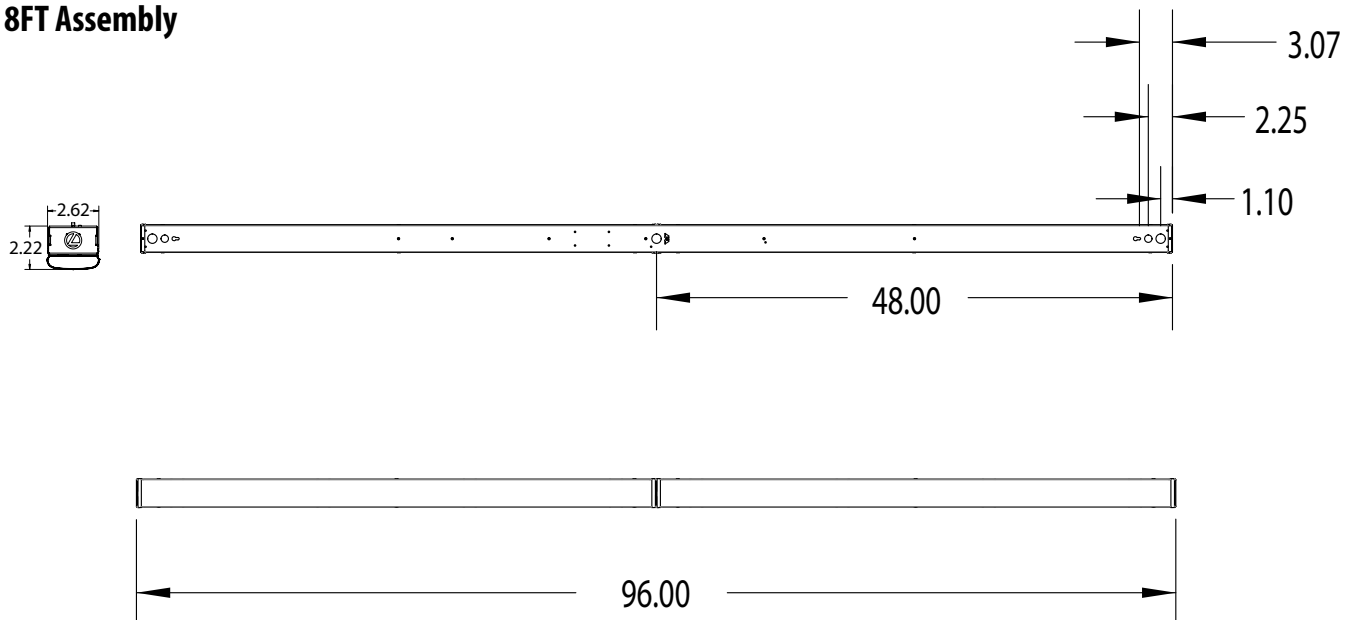

PERFORMANCE DATA

MVOLT

Nominal Length	Nominal Lumen Package	Color Temperature	Delivered Lumens	Wattage	Lumens/Watt	
L24	1500 LM	3000K	1464	11	131	
	2000 LM		1941	15	131	
	2500 LM		2417	19	129	
	1500 LM	3500K	1510	11	135	
	2000 LM		2002	15	135	
	2500 LM		2493	19	133	
	1500 LM	4000K	1589	11	142	
	2000 LM		2107	15	142	
	2500 LM		2623	19	140	
	1500 LM	5000K	1589	11	142	
	2000 LM		2107	15	142	
	2500 LM		2623	19	140	
	ALO15 (1500LM)	3500K	1610	13	125	
			4000K	1609	13	125
			5000K	1609	13	125
		4000K	1610	13	125	
			4000K	1609	13	125
			5000K	1609	13	125
ALO15 (2000LM)		3500K	2129	16	133	
			4000K	2129	16	133
			5000K	2129	16	133
ALO15 (2500LM)	3500K	2648	19	138		
		4000K	2648	19	140	
		5000K	2648	19	140	
L48	3000 LM	3000K	3009	22	134	
	4000 LM		4101	30	136	
	5000 LM		4948	38	132	
	6000 LM		5954	45	131	
	7000 LM		6991	55	128	
	3000 LM	3500K	3088	22	138	
	4000 LM		4208	30	140	
	5000 LM		5078	38	135	
	6000 LM		6111	45	135	
	7000 LM		7175	55	131	
	3000 LM	4000K	3179	22	142	
	4000 LM		4333	30	144	
	5000 LM		5228	38	139	
	6000 LM		6291	45	138	
	7000 LM		7387	55	135	
	3000 LM	5000K	3179	22	142	
	4000 LM		4333	30	144	
	5000 LM		5228	38	139	
	6000 LM		6291	45	138	
	7000 LM		7387	55	135	
	ALO3 (3000LM)	3500K	3432	23	148	
		4000K	3602	22	161	
		5000K	3501	23	149	
	ALO3 (4000LM)	3500K	4360	30	145	
		4000K	4606	29	159	
		5000K	4446	30	148	
	ALO3 (5000LM)	3500K	5245	38	138	
4000K		5585	37	152		
5000K		5346	38	140		

UVOLT

Nominal Length	Nominal Lumen Package	Color Temperature	Delivered Lumens	Wattage	Lumens/Watt	
L24	1500 LM	3000K	1464	11	131	
	2000 LM		1941	15	131	
	2500 LM		2417	19	129	
	1500 LM	3500K	1510	11	135	
	2000 LM		2002	15	135	
	2500 LM		2493	19	133	
	1500 LM	4000K	1589	11	142	
	2000 LM		2107	15	142	
	2500 LM		2623	19	140	
	1500 LM	5000K	1589	11	142	
	2000 LM		2107	15	142	
	2500 LM		2623	19	140	
	ALO15 (1500LM)	3500K	1610	13	125	
			4000K	1609	13	125
			5000K	1609	13	125
		4000K	1610	13	125	
			4000K	1609	13	125
			5000K	1609	13	125
ALO15 (2000LM)		3500K	2129	16	133	
			4000K	2129	16	133
			5000K	2129	16	133
ALO15 (2500LM)	3500K	2648	19	138		
		4000K	2648	19	140	
		5000K	2648	19	140	
L48	3000 LM	3000K	3009	22	134	
	4000 LM		4101	30	136	
	5000 LM		4948	38	132	
	6000 LM		5954	45	131	
	7000 LM		6991	55	128	
	3000 LM	3500K	3088	22	138	
	4000 LM		4208	30	140	
	5000 LM		5078	38	135	
	6000 LM		6111	45	135	
	7000 LM		7175	55	131	
	3000 LM	4000K	3179	22	142	
	4000 LM		4333	30	144	
	5000 LM		5228	38	139	
	6000 LM		6291	45	138	
	7000 LM		7387	55	135	
	3000 LM	5000K	3179	22	142	
	4000 LM		4333	30	144	
	5000 LM		5228	38	139	
	6000 LM		6291	45	138	
	7000 LM		7387	55	135	
	ALO3 (3000LM)	3500K	3432	23	148	
		4000K	3602	22	161	
		5000K	3501	23	149	
	ALO3 (4000LM)	3500K	4360	30	145	
		4000K	4606	29	159	
		5000K	4446	30	148	
	ALO3 (5000LM)	3500K	5245	38	138	
4000K		5585	37	152		
5000K		5346	38	140		

PERFORMANCE DATA

MVOLT *continued*

Nominal Length	Nominal Lumen Package	Color Temperature	Delivered Lumens	Wattage	Lumens/Watt
L96	6000 LM	3000K	5701	43	132
	8000 LM		7929	58	136
	10000 LM		9681	73	132
	12000 LM		11628	92	126
	14000 LM		13612	112	122
	6000 LM	3500K	5851	43	136
	8000 LM		8137	58	139
	10000 LM		9935	73	136
	12000 LM		11934	92	130
	14000 LM		13970	112	125
	6000 LM	4000K	6024	43	140
	8000 LM		8377	58	144
	10000 LM		10228	73	140
	12000 LM		12286	92	133
	14000 LM		14382	112	128
	6000 LM	5000K	6024	43	140
	8000 LM		8377	58	144
	10000 LM		10228	73	140
	12000 LM		12286	92	133
	14000 LM		14382	112	128
	ALO4 (6000LM)	3500K	6528	43	153
		4000K	6739	43	158
		5000K	6590	43	154
	ALO4 (8000LM)	3500K	8389	58	144
4000K		8741	58	150	
5000K		8497	58	145	
ALO4 (10000LM)	3500K	10386	74	140	
	4000K	10907	74	147	
	5000K	10487	74	141	

UVOLT *continued*

Nominal Length	Nominal Lumen Package	Color Temperature	Delivered Lumens	Wattage	Lumens/Watt
L96	6000 LM	3000K	5701	43	132
	8000 LM		7929	58	136
	10000 LM		9681	73	132
	12000 LM		11628	92	126
	14000 LM		13612	112	122
	6000 LM	3500K	5851	43	136
	8000 LM		8137	58	139
	10000 LM		9935	73	136
	12000 LM		11934	92	130
	14000 LM		13970	112	125
	6000 LM	4000K	6024	43	140
	8000 LM		8377	58	144
	10000 LM		10228	73	140
	12000 LM		12286	92	133
	14000 LM		14382	112	128
	6000 LM	5000K	6024	43	140
	8000 LM		8377	58	144
	10000 LM		10228	73	140
	12000 LM		12286	92	133
	14000 LM		14382	112	128
	ALO4 (6000LM)	3500K	6528	43	153
		4000K	6739	43	158
		5000K	6590	43	154
	ALO4 (8000LM)	3500K	8389	58	144
4000K		8741	58	150	
5000K		8497	58	145	
ALO4 (10000LM)	3500K	10386	74	140	
	4000K	10907	74	147	
	5000K	10487	74	141	

Note: All values are typical and are at 25C.
Actual performance may vary and is dependent on operating environment.

PROJECTED LUMEN MAINTENANCE			
Lumen Maintenance Factor	0.92	0.83	0.78
Operating Hours	40,000	90,000	120,000

Note: Actual performance may vary based on ambient temperature of installed location.

PHOTOMETRICS

Please click link to access [Photometry & Revit \(BIM\)](#)

Fixture Ambient Ratings

Lumen Package	Length	Emergency	Controls	Ambient Max Temp				
				25C	35C	40C	45C	
ALO	L24	-	-		X			
		-	X		X			
		-	-				X	
		X	X				X	
	L48	-	-					
		-	X				X	
		X	-			X		
		X	X					
	L96	-	-		X			
		-	X		X			
		X	X		X			
		X	-		X			
2500LM	L24	-	-			X		
		-	X			X		
3000LM	L48	-	-			X		
		-	X			X		
		X	X			X		
		X	-			X		
4000LM			-	-			X	
		-	X			X		
		X	X			X		
		X	-			X		
5000LM			-	-		X		
		-	X		X			
		X	X		X			
		X	-		X			
6000LM		-	-		X			
	-	X		X				
	X	X		X				
	X	-		X				
7000LM		-	-			X		
	-	X	X	X				
	X	X	X					
	X	-			X			
6000LM	L96	-	-		X			
		-	X		X			
		X	X		X			
		X	-		X			
8000LM			-	-			X	
		-	X			X		
		X	X			X		
		X	-			X		
10000LM			-	-			X	
		-	X			X		
		X	X			X		
		X	-			X		
12000LM		-	-		X			
	-	X		X				
	X	X		X				
	X	-		X				
14000LM		-	-		X			
	-	X		X				
	X	X		X				
	X	-		X				