

# PL-160 Square ADA Privacy Installation Diagram

(Minimum Door Thickness 1-3/8")

SKU: PL160S-AD-PR

PL-160 Trim Requires Precise Installation.  
Otherwise, It May Not Function Properly.

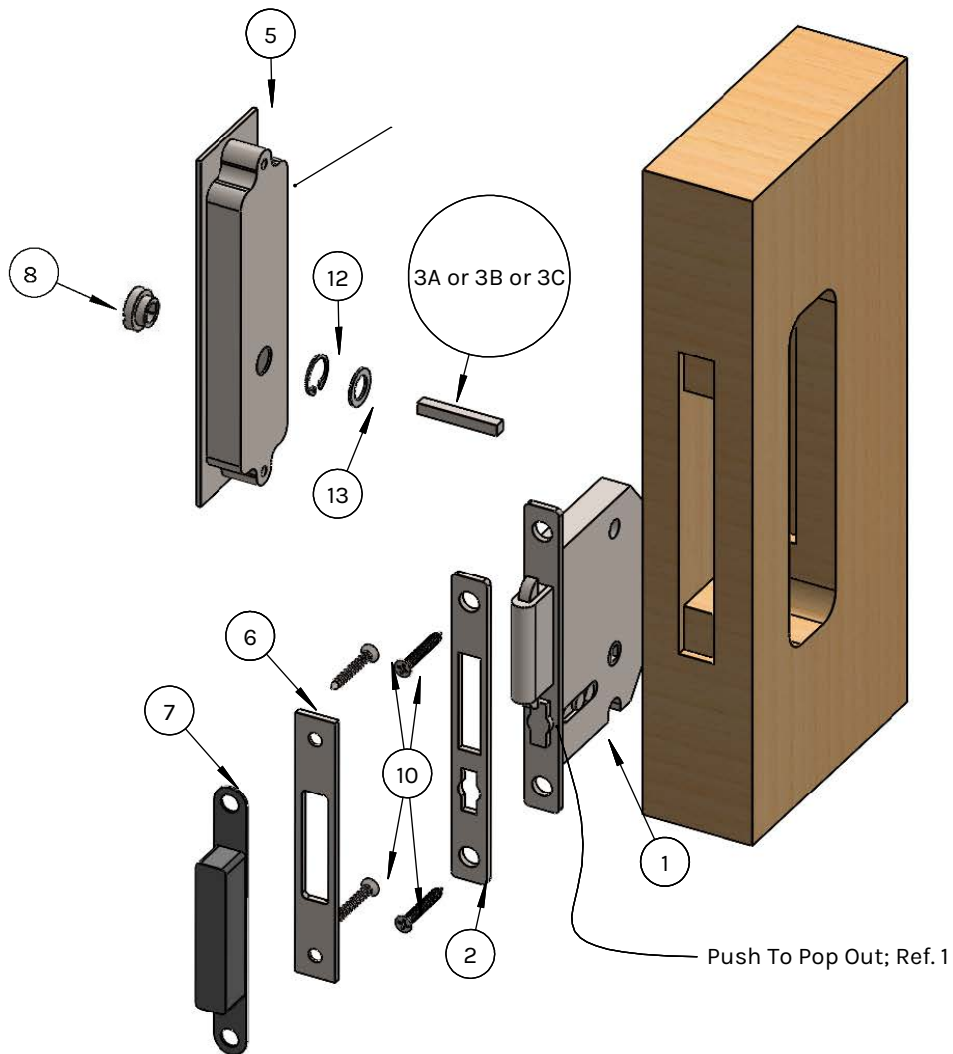

1. Knobs and emergency releases are supplied pre-installed.
2. The ADER extended emergency release can act as a pull, so an additional handle isn't required.
3. ADA locks are designed to prevent the pocket door from completely entering the pocket
4. Trims aren't required to be recessed to accommodate pocket width; but a door thickness of 1-3/4" is required if opting for a recessed trim. Trims cannot be recessed on a 1-3/8" thick door.
5. Measure the trim dimensions before cutting the door due to minor tolerances in overall dimensions.
6. The backset of the mortise lock case is 52.5mm (metric). A 2" backset will not allow proper function.

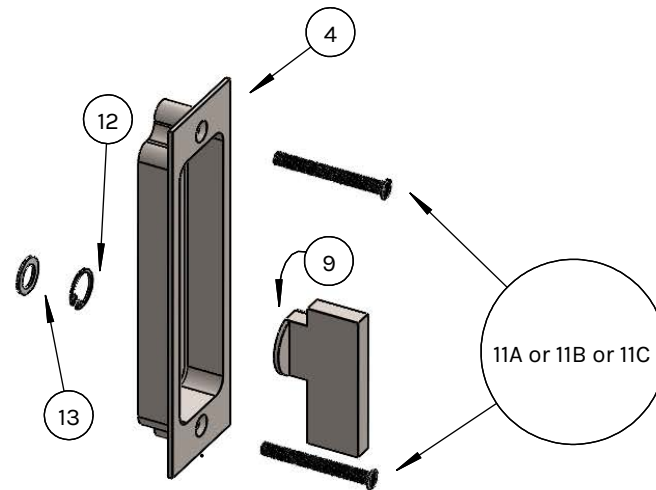

linnea.

linnea-home.com  
(800) 219-2366

# Component List

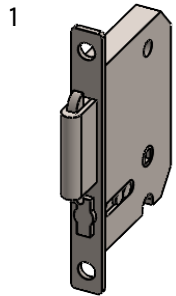

**1**  
**Mortise Lock**  
PLM-50PR-UNF  
(Needs 1)

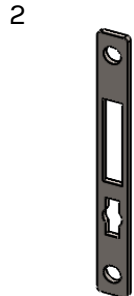

**2**  
**Face Plate**  
PLM-50PR-FP  
(Needs 1)

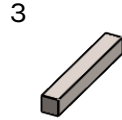

**3**  
**Spindle**  
3A: PL-SPDL31  
3B: PL-SPDL36  
3C: PL-SPDL41

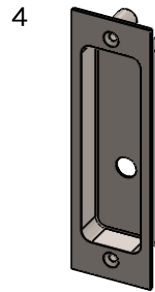

**4**  
**Inside Trim**  
PLA-160ST-I  
(Needs 1)

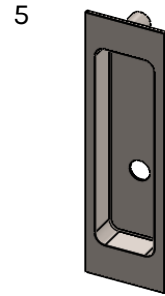

**5**  
**Outside Trim**  
PLA-160ST-O  
(Needs 1)



**6**  
**Strike Plate**  
PLM-50PR-ST  
(Needs 1)

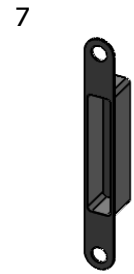

**7**  
**Dust Box**  
PL-DBOX160  
(Needs 1)



**8**  
**Emergency Release**  
PL-KNER  
(Needs 1)

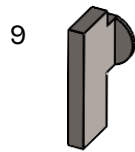

**9**  
**ADA Turnpiece**  
PL-KNADA  
(Needs 1)

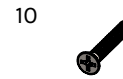

**10**  
**Wood Screw**  
#8 x 3/4  
(Needs 4)



**12**  
**Snap Ring**  
PL-CCLIP11  
(Needs 2)



**11**  
**Machine Screw**  
11A: PL-OVSCR35  
11B: PL-OVSCR45  
11C: PL-OVSCR50

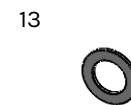

**13**  
**Plastic Washer**  
PL-WAS12  
(Needs 2)

Ref. 1

