

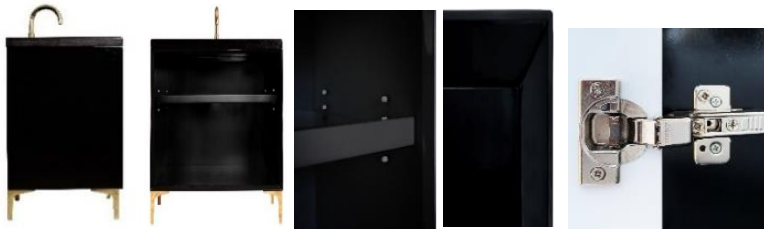

Shown in PN





VAN24B-016-SLV

24" BLACK MOTHER OF PEARL WITH 8" ARTISAN GLASS
HARDWARE ÉGLOMISÉ PRISM GLASS

DETAILS

Cabinet with Gloss Finish
Full Finished Back
Adjustable Interior Shelf
3 Way Adjustable European Soft Close Hinges
OD: W 24" x D 22"
Vanities are Hand-crafted

HARDWARE AND LEG FINISH OPTIONS

	PN	Polished Nickel
	SN	Satin Nickel

24" VANITY TOP OPTIONS

(Vanity Top Sold Separately See Vanity Top Spec Sheet for Details)

Outside Dimensions W 24" D 22" H 1.5"

(Vanity Top includes 4" Backsplash)

VT24W-01	14" x 14" Sink Cutout with 1 Faucet Hole
VT24W-03	14" x 14" Sink Cutout with 3 Faucet Holes

INSTALLATION

We recommend consulting a professional if you are unfamiliar with installing bathroom fixtures and plumbing. Linkasink accepts no liability for any damage to the floor, walls, plumbing, or personal injury during installation.

CARE

Clean vanity, hardware, and countertop with a soft cloth dampened with water. Avoid any harsh abrasives and harsh chemicals/acidic cleaning products.
For hardware: A clear paste wax may be applied periodically to protect the finish and help with water spotting.

WARRANTY

Linkasink warranties our product to be free from manufacturing defect for the life of the product. Warranty does not cover improper care, neglect, abuse or normal wear-and-tear.

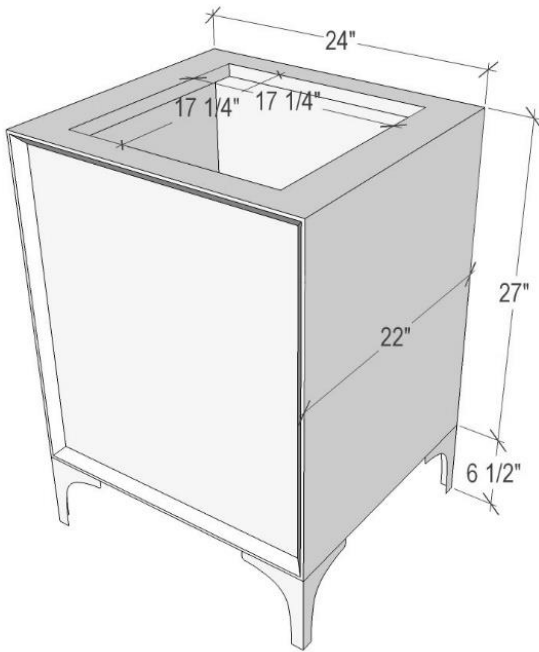

DIMENSIONS WILL VARY

DO NOT use this sheet as a guide for countertop cuts. Due to the handmade nature of each product, templates are not provided.