

LIEBHERR

Installation Instructions

For NoFrost Combined
Refrigerator-Freezers with IceMaker

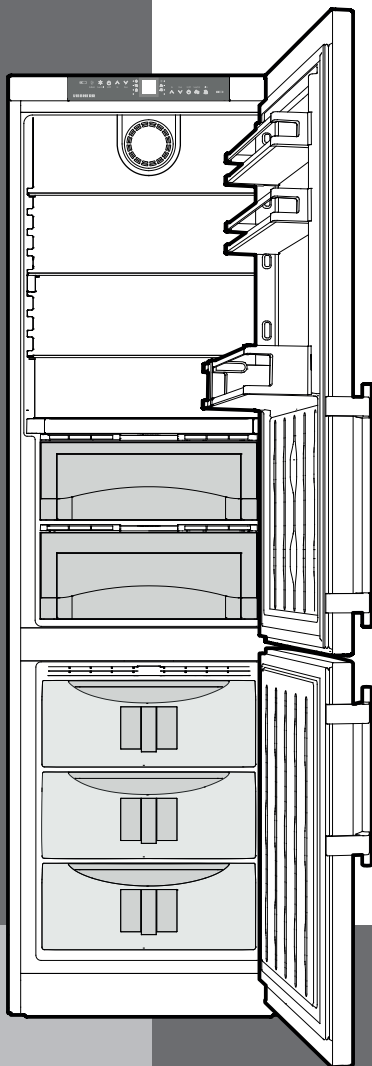

CBS 1360
7085 549-00

IMPORTANT

Please Read and Follow these Instructions

These instructions contain Danger, Warning and Caution notes.

This information is important for safe and efficient installation and operation.

Always read and comply with all Danger, Warning and Caution notes!



DANGER!

Danger indicates a hazard which will cause serious injury or death if precautions are not followed.



WARNING!

Warning indicates a potentially hazardous situation which, if not avoided, could result in death or serious injury.



CAUTION!

Caution indicates a potentially hazardous situation which, if not avoided, may result in minor or moderate injury.

IMPORTANT

This indicates information that is especially relevant to a problem-free installation and operation.

Note to the Installer

It is very important to follow the instructions in the manual to ensure proper installation and operation of the unit.

Before installing the unit, be sure to thoroughly read and understand all of the information in this manual.



WARNING!

Electrocution hazard.

Do not connect to the electrical outlet before the installation is completed.

Content

Content	Page
Please Read and Follow these Instructions.....	2
Note to the Installer.....	2
R600a Refrigerant	2
Disposal of Old Appliance	3
Disposal of Carton	3
Electrical Safety	3
Blocking for Safety.....	3
Appliance Dimensions.....	4
Cabinet Opening Dimensions	5
Unit Venting.....	6
Leveling the Appliance	6
Mounting the anti tipping device	7
Safety Instructions and Warnings	8
Water Connection Requirements	8
Water Connection Adapter	8
Connection to the Water Supply	9
Changing Over Door Hinges	10

R600a Refrigerant



WARNING!

The refrigerant contained within the appliance R600a is environmentally friendly, but flammable. Leaking refrigerant can ignite.

To prevent possible ignition follow the warnings below:

- **Keep ventilation openings, in the appliance enclosure or in the built-in structure, clear of obstruction.** →
- **Do not damage the refrigerant circuit.**
- **Component parts and power cords shall be replaced with like components performed by factory authorized service personnel only.**

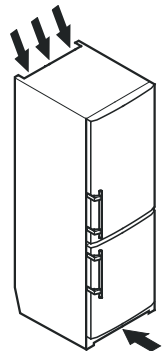

Disposal of Old Appliance



DANGER!

Risk of child entrapment.

Child entrapment and suffocation are not problems of the past.

Junked or abandoned refrigerators are still dangerous – even if they will sit for “just a few days.”

If you are getting rid of your old refrigerator, please follow these instructions to help prevent accidents.

Before you discard old appliances:

- **Take off the doors.**
- **Leave the shelves in place so that children may not easily climb inside.**
- **Cut off the power cable from the discarded refrigerator. Discard separately from the refrigerator.**
- **Be sure to follow your local requirements for disposal of appliances.**

Contact the trash collection agency in your area for additional information.

Disposal of Carton

The packaging is designed to protect the appliance and individual components during moving and is made of recyclable materials.



WARNING!

Keep packaging materials away from children. Polythene sheets and bags can cause suffocation!

Please recycle packaging material where facilities are available.

Electrical Safety

Connect this appliance to a 15 amp or 20 amp, 110-120 VAC, circuit which is grounded and protected by a circuit breaker or fuse.

We recommend using a dedicated circuit for this appliance to prevent circuit overload and the chance of interruption to the appliance.

This appliance is equipped with a three-prong (grounding) polarized plug for your protection against possible shock hazards.

Where a two-prong wall receptacle is encountered, contact a qualified electrician and have it replaced with a properly grounded three-prong receptacle in accordance with all local codes and ordinances.

Disconnect power before installing optional Side By Side Kit.



WARNING!

Electrocution hazard.

Electrical grounding required.

- **Do not remove the round grounding prong from the plug.** →
- **Do not use extension cords or ungrounded (two prong) adapters.**
- **Do not use a power cord that is frayed or damaged.**

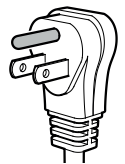

- **Do not use a power strip.** →

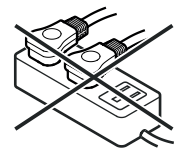

Failure to follow these instructions may result in fire, electrical shock or death.

Blocking for Safety



WARNING!

To avoid a hazard due to instability of the appliance, it must be fixed in accordance with the instructions.

PLANNING INFORMATION

Appliance Dimensions

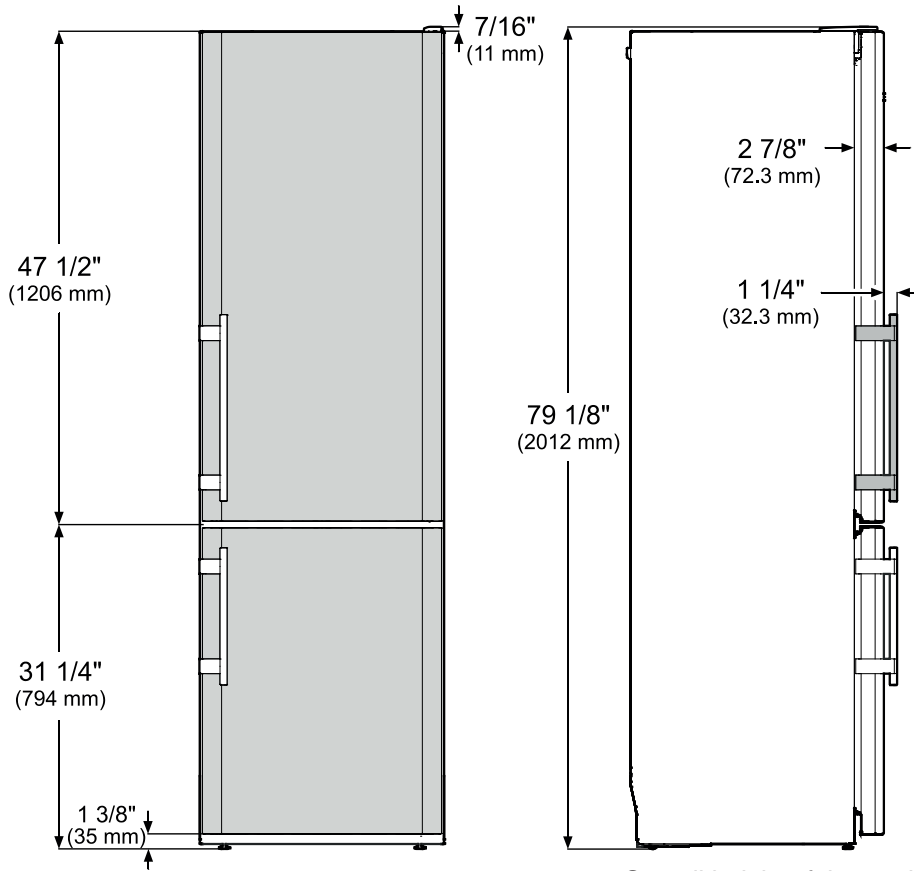

Overall height of the appliance can be increased by a maximum of 5/8" (see Leveling the appliance).

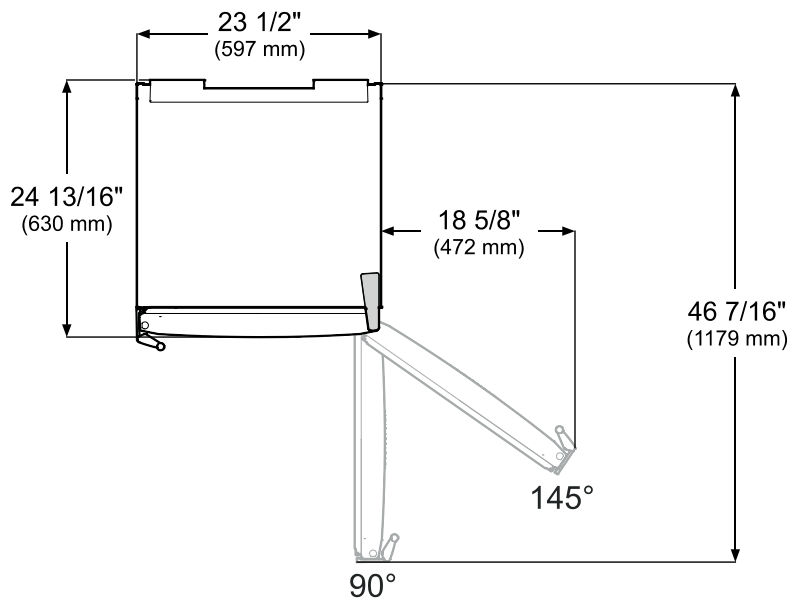

Cabinet Opening Dimensions

The appliance can be used freestanding or semi built-in.

If semi built-in, please consider the cabinet opening dimensions.

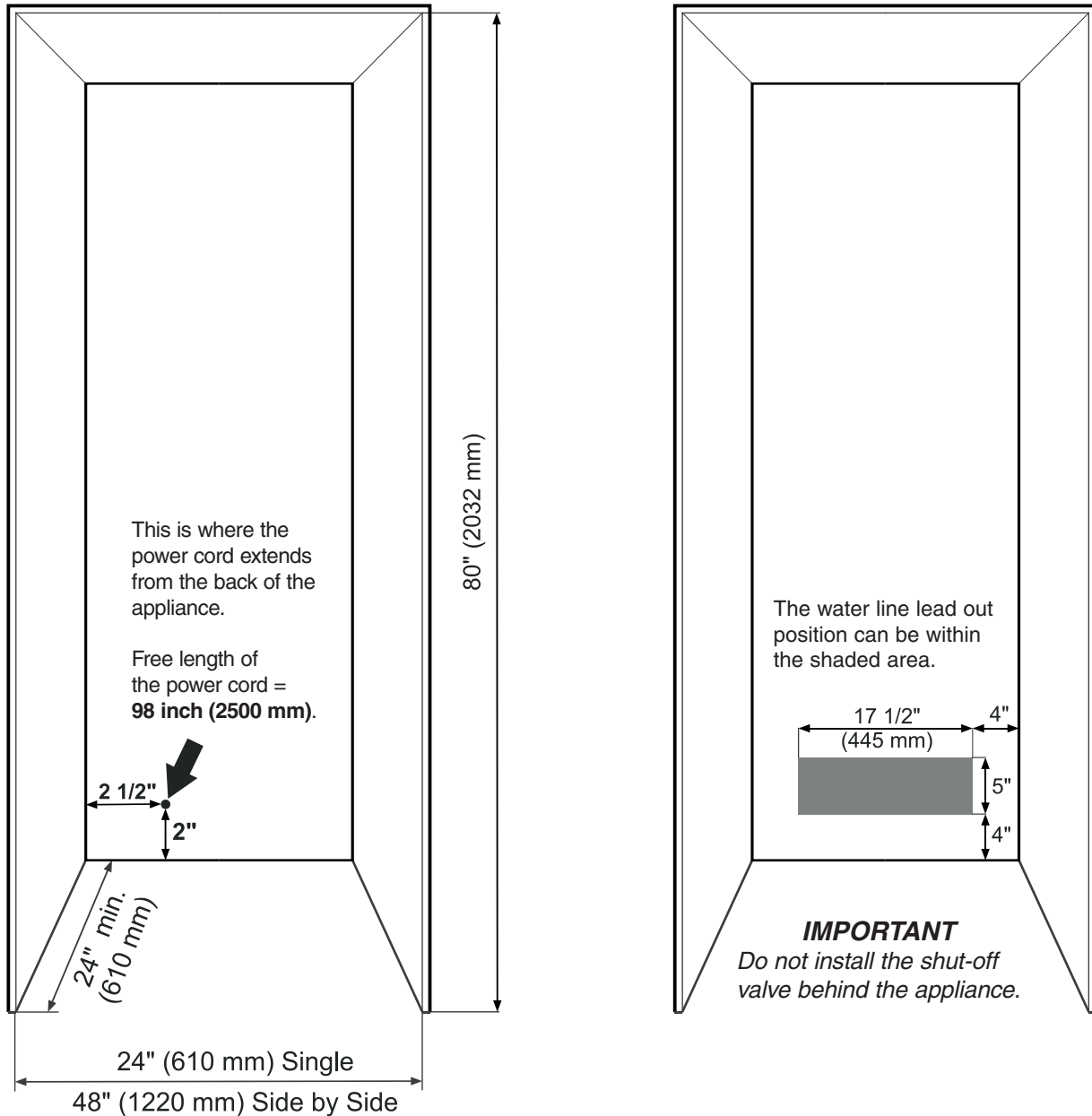

IMPORTANT

The power plug must be easily accessible so that the appliance can be disconnected from the mains quickly in an emergency. It must not be behind the back of the appliance.

Clearance on the back must be 2 inch (51 mm).

NOTE

If the gap between the rear of the appliance and the wall is less than 2 inch (51 mm), the power consumption level may increase

INSTALLATION

Unit Venting

Do not restrict the air flow.

The ventilation opening can either be directly over the appliance ①, above the cabinet and below the ceiling ② or through a vent installed in a soffit ③.

IMPORTANT

The clear ventilation cross-section must be at least 31 in² (200 cm²) from the lower ventilation opening right to the upper one.

The section below the freezer door and the floor must not be covered.

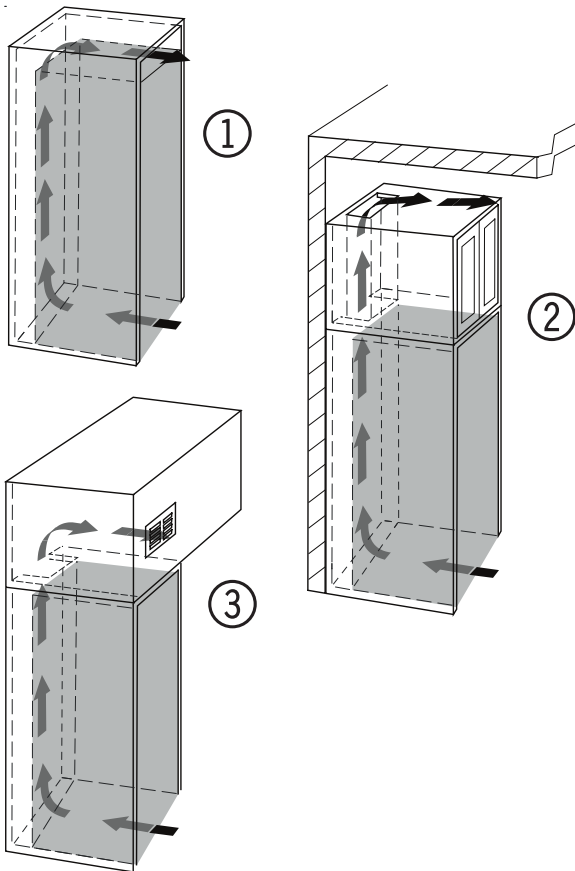

Leveling the Appliance

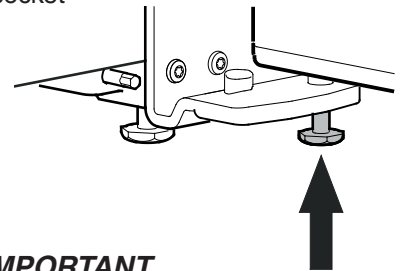
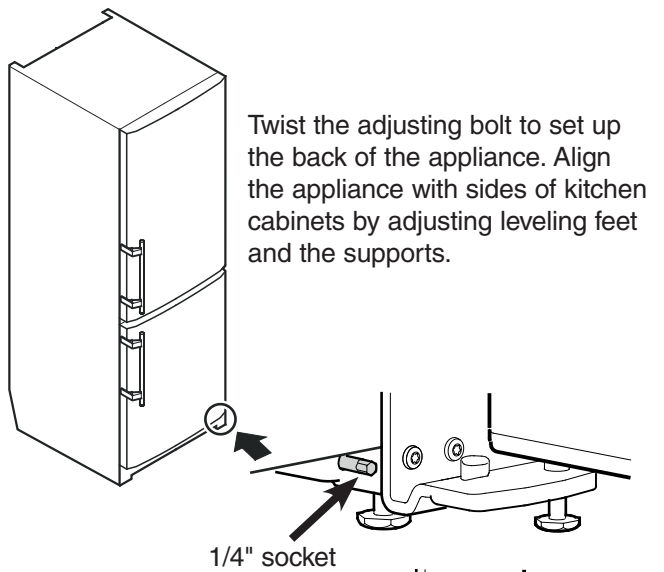
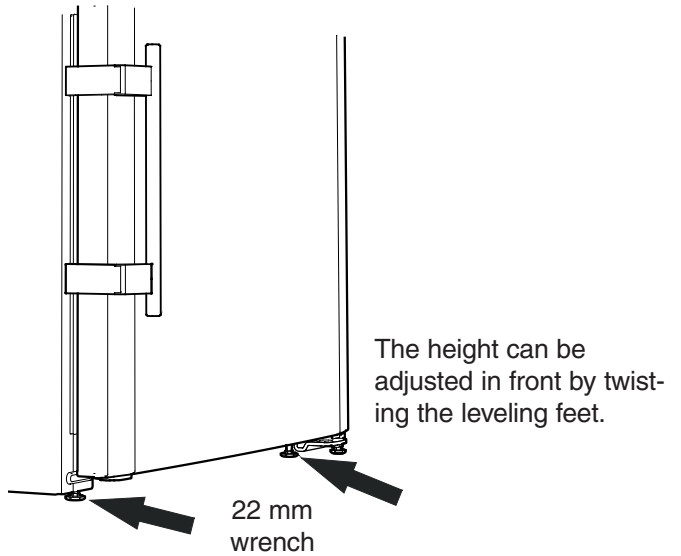

IMPORTANT

After final installation, this screw must be turned down until it has proper floor contact to support the hinge bracket.

Mounting the anti tipping device



WARNING!

Tip over hazard!

The anti tipping bracket must be mounted to prevent the appliance from tipping when the fully stocked door is opened.

IMPORTANT

Be sure that there is no plumbing or electrical wiring located in this area which screws or drills could damage.

1. Mark the center of the appliance on the back wall.
2. Mount the anti tipping bracket.

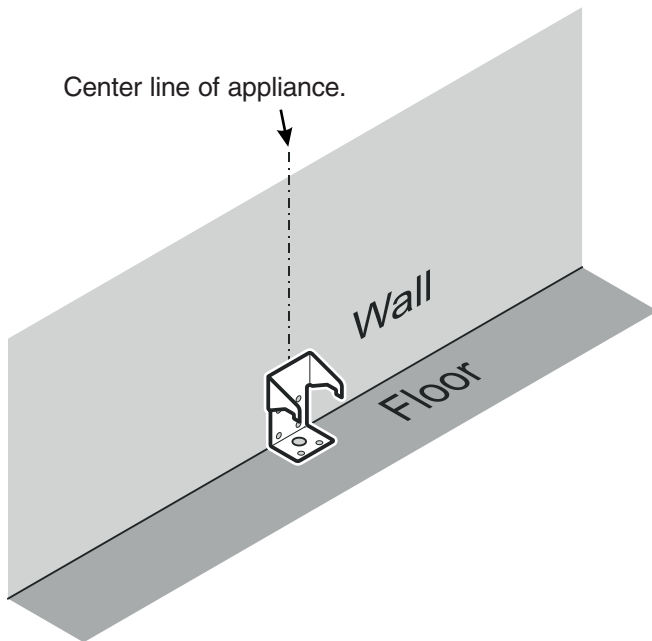

IMPORTANT

The screws for fastening the anti-tip device are not supplied with the appliance. Appropriate screws must be used for the material (wood, concrete, etc.) in which the safety device is mounted.

ICE MAKER

Safety Instructions and Warnings

- Do not install the water connection while the combined refrigerator-freezer is connected to an electrical outlet.
- The connection to the water supply may only be made by a trained and licensed plumber.
- All equipment and devices used to supply the water to the appliance must comply with the current regulations for your geographical area.



WARNING!

Connect to potable water supply only.

Water Connection Requirements

- The water supply pressure requirements are different based on whether or not the supplied Liebherr water filter is installed.

With the filter installed, the pressure must be in the range of **40-90 psi (2.8-6.2 bar)**.

Without the filter installed, the acceptable pressure range is **22-87 psi (1.5-6 bar)**.

Failure to meet these requirements will likely result in ice maker malfunction and possibly cause a water leakage that can damage flooring and surrounding furniture.

- A shut-off valve, must be installed between the hose line and the main water supply so the water supply can be stopped if necessary.

IMPORTANT

Do not install the shut-off valve behind the appliance.

Water Connection Adapter

IMPORTANT

Only use the supplied adapter for connection to the solenoid valve. The solenoid valve has a metric R3/4 male connector. Any attempt to use other adapters for connection could damage the thread on the solenoid valve.

The supplied adapter enables different connection options for different kinds of water lines. A water line is not supplied with the appliance.

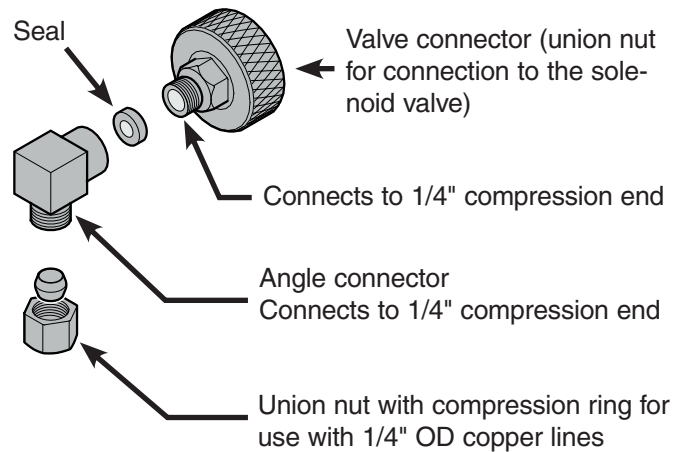

The connection to the valve connector can be done with or without the angle connector, as required.

Braided style ice maker hoses can be connected directly to the threaded ends.

For connection with 1/4" OD copper lines, use the union nut with compression ring.

IMPORTANT

Make sure that the connection is fitted with a seal and is tight.

- Insert the water strainer supplied into the valve connector.

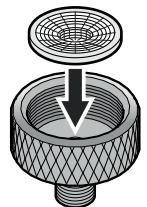

Connection to the Water Supply

1. Move the appliance towards the final position and leave enough space to work behind.
2. Remove the cover from the solenoid valve.

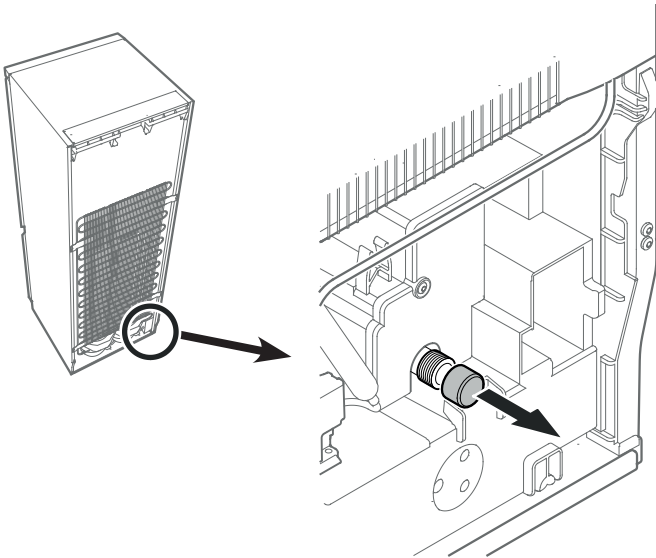

3. Connect the water line to the adapter in the respective configuration, depending on the type of water line used.

The figure shows the configuration with a copper line as an example. →

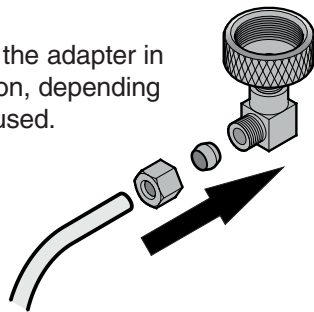

4. Bleed the air from the water line by opening the water supply temporarily.

5. Screw the adapter onto the solenoid valve.

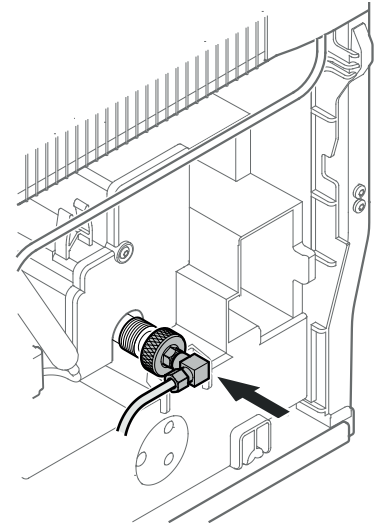

6. Move the power supply line to the area of the electrical outlet.

⚠ WARNING!

Do not connect to the electrical outlet before the installation is completed and the water line is connected to the solenoid valve.

7. Push the appliance slowly to the back wall. Make sure the water line does not interfere with the anti tipping bracket(s).
8. Open the shut-off valve for the water supply and check the entire water system for leaks.

REVERSING DOOR HINGES

Changing Over Door Hinges

Door hinges should only be changed by a trained expert.

Changing over the door hinges requires two people.

1. Open top door, pry off door cover and pivot to the left.

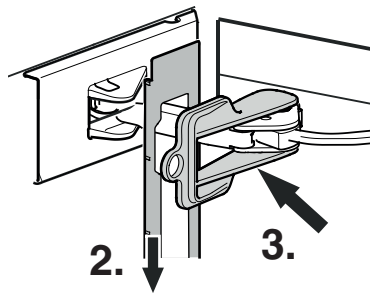
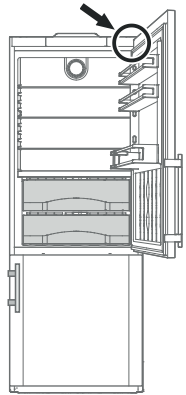
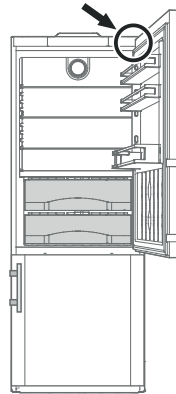
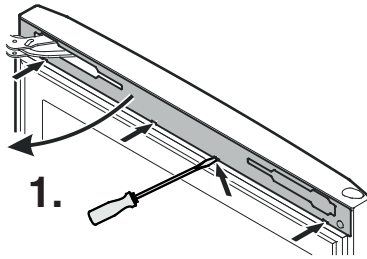

2. Let door cover hang down.
3. Slide red safety bracket over the hinge.

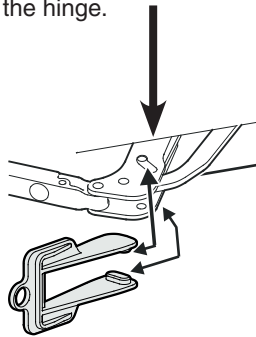

IMPORTANT

The two knobs on the safety bracket must be fully inserted into the marked openings on the hinge.

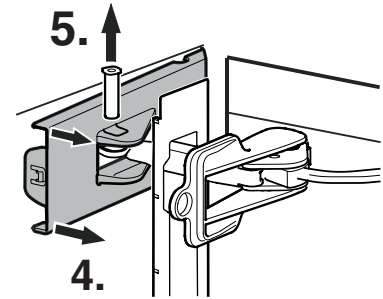

4. Pull the left-hand side of the cover approx. 1/4" (6 mm) towards you.
5. Remove pin.

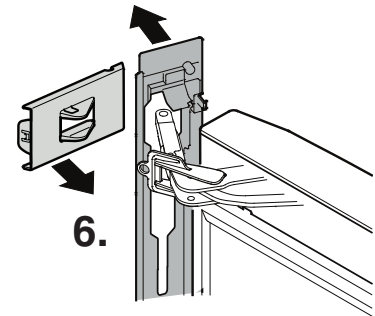
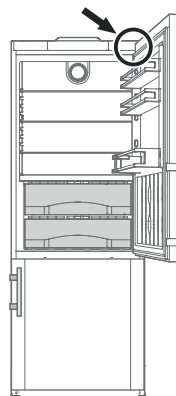

6. Open top door wide and remove covers.

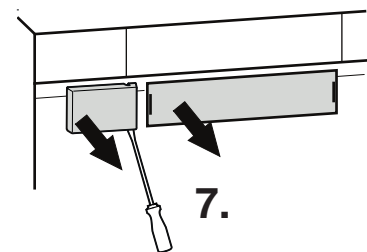
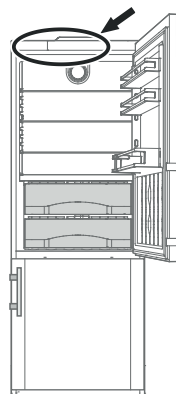

7. Pry off covers on the left and in the center.

REVERSING DOOR HINGES

IMPORTANT

The door must now be held secure by another person.

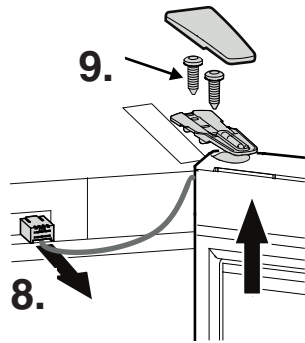
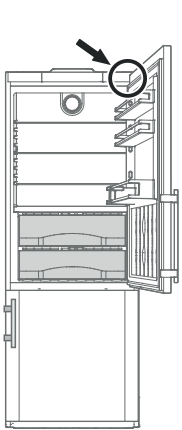

- 8. Disconnect the connector and pull the cable out of the guide.
- 9. Remove cover from upper door mounting and unscrew door.

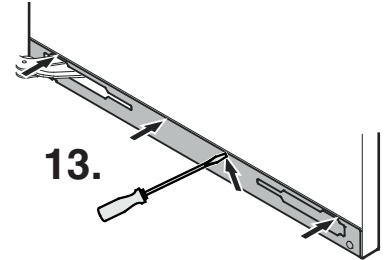
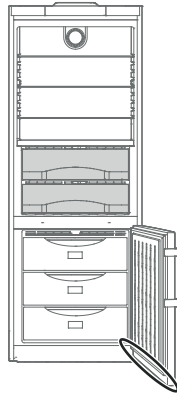

- 13. Open bottom door, pry off door cover.

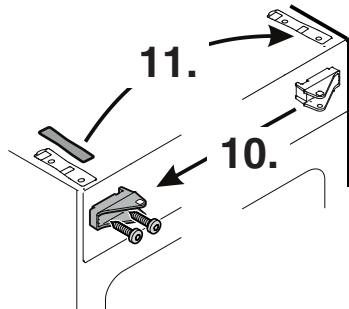
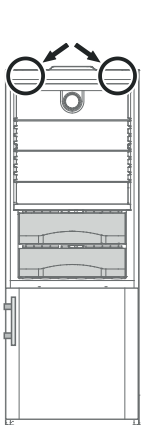

- 10. Transfer fastener for soft stop mechanism to the opposite side.
- 11. Transfer cover plate to the opposite side.

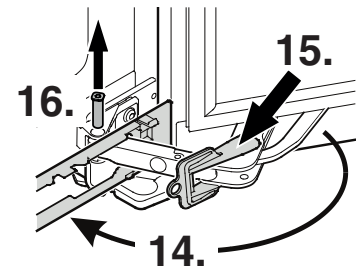
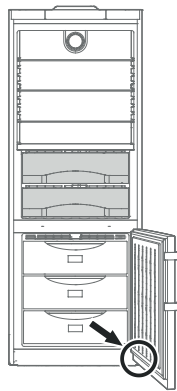

- 14. Pivot door cover to the left.
- 15. Slide red safety bracket over the hinge.
- 16. Remove pin.

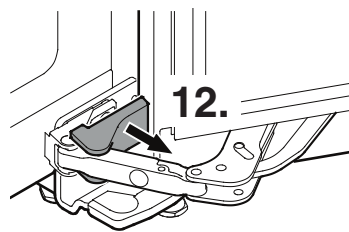
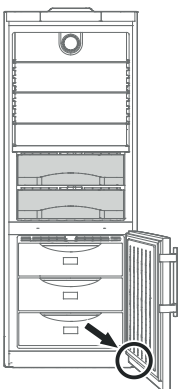

- 12. Remove cover.

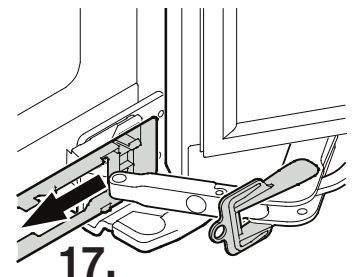
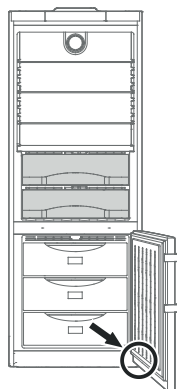

- 17. Open bottom door wide and remove cover.

REVERSING DOOR HINGES

IMPORTANT

The door must now be held secure by another person.

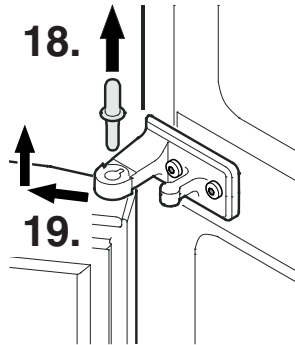
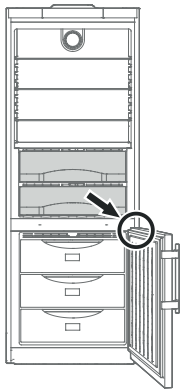

- 18. Pull out middle hinge pin.
- 19. Remove bottom door.

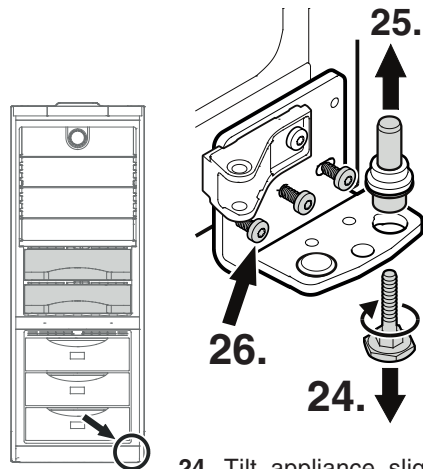

- 24. Tilt appliance slightly backwards and unscrew the adjustable foot.
- 25. Remove the hinge pin.
- 26. Unscrew hinge bracket.

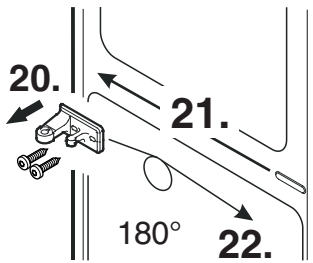
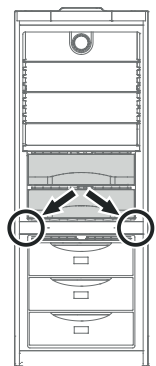

- 20. Unscrew hinge bracket.
- 21. Transfer cover plate to the opposite side.
- 22. Turn hinge bracket through 180° and screw into place.

- 27. Transfer fastener for soft stop mechanism on hinge bracket to the opposite side.

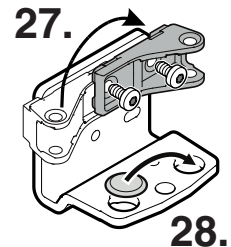

- 28. Transfer cover to the opposite side.

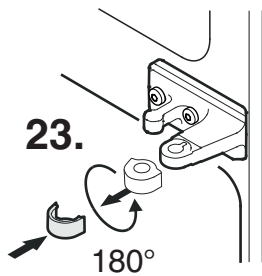
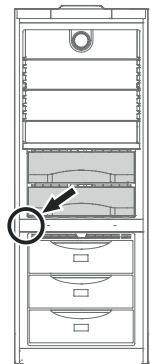

- 23. Remove hinge bushing, turn through 180° and re-fit.

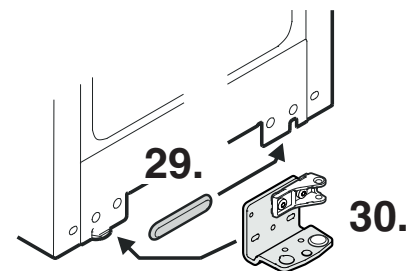
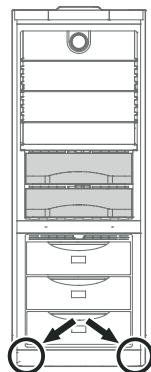

- 29. Transfer cover plate to the opposite side.
- 30. Screw hinge bracket into place.

REVERSING DOOR HINGES

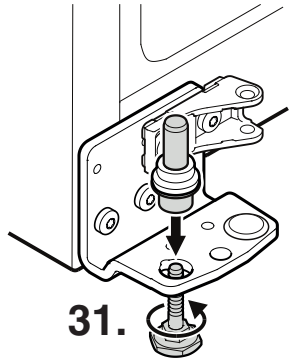
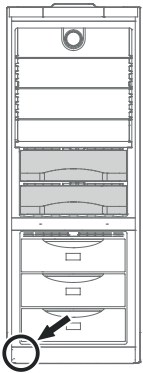

31. Tilt appliance slightly backwards, insert pin and attach using the adjustable foot.

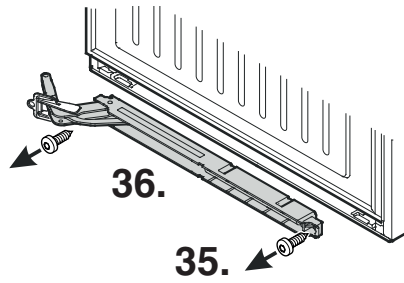

Both doors

35. Remove screw.

36. Pivot soft stop mechanism outwards on the left, pull to the left and remove.

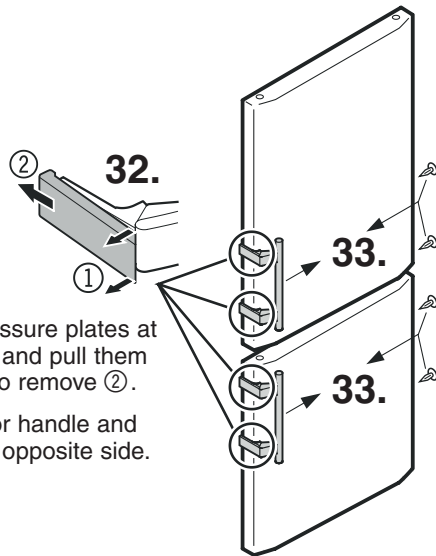

32. Release pressure plates at the front ① and pull them backwards to remove ②.

33. Transfer door handle and plugs to the opposite side.

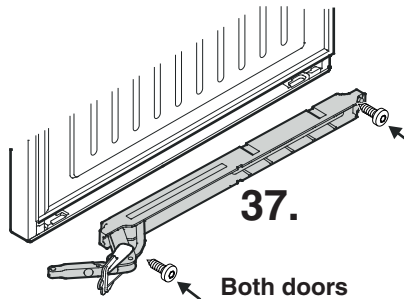

Both doors

37. Turn soft stop mechanism through 180° and re-fit on the opposite side.

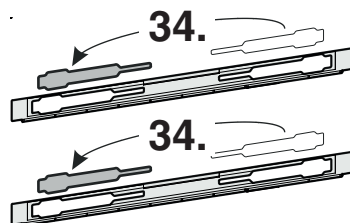

34. Transfer panels of both door covers to the opposite side.

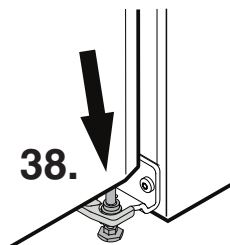
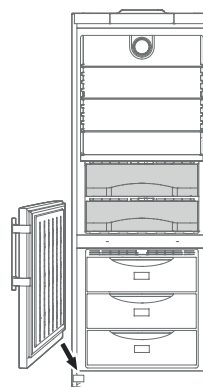

38. Suspend bottom door on hinge pin.

IMPORTANT

The door must now be held secure by another person.

REVERSING DOOR HINGES

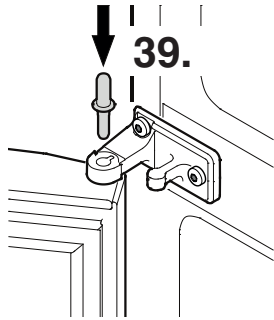
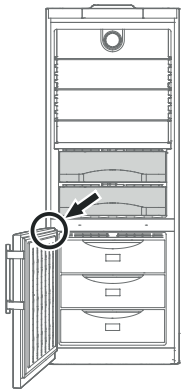

39. Insert middle hinge pin.

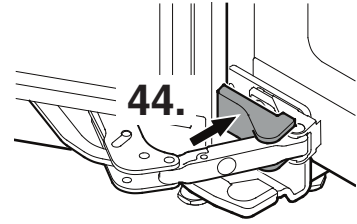
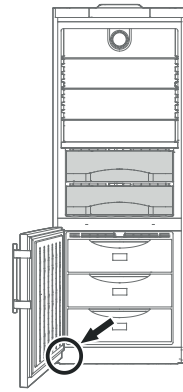

44. Click cover into place.

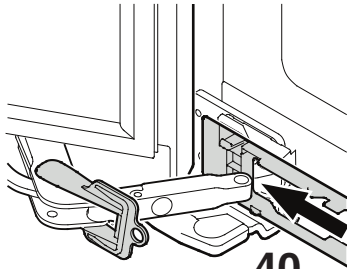
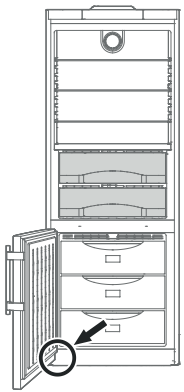

40. Slide door cover over soft stop mechanism hinge.

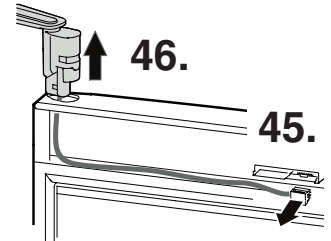
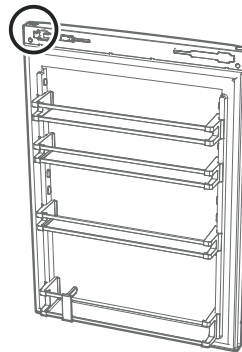

45. Disconnect the connector.

46. Using a screwdriver, push out the hinge from underneath and remove it from the door complete with the cable.

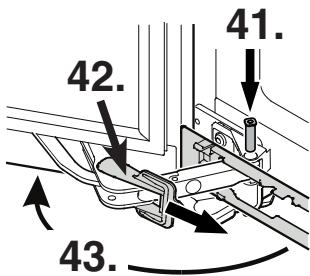
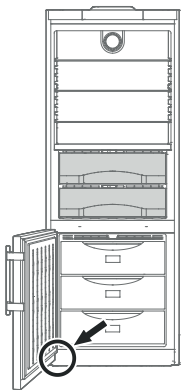

41. Move soft stop mechanism hinge to the fastener and insert pin.

42. Remove red safety bracket.

43. Pivot door cover to the left and click into place on the door.

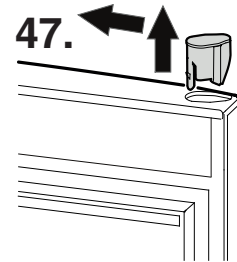
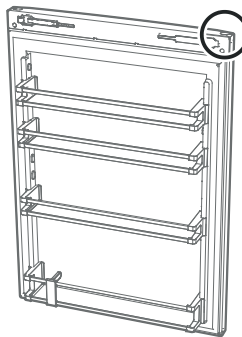

47. Using a screwdriver, push out the plug from underneath and transfer it to the opposite side.

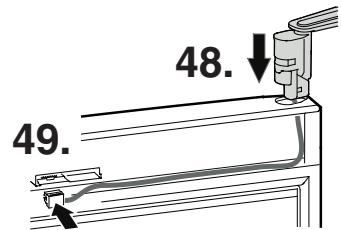
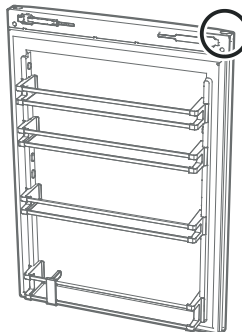

48. Feed in the cable of the hinge at the opposite side and insert hinge.

49. Plug in the connector. Place the cable in the guide.

REVERSING DOOR HINGES

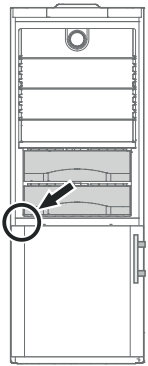

50. Suspend top door on hinge pin. For this, the door must be open at least 90°.

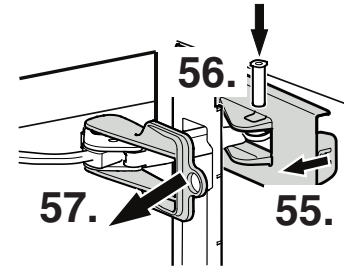
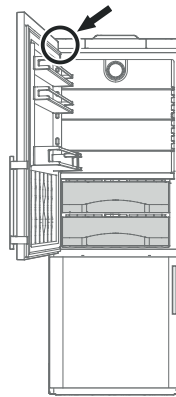
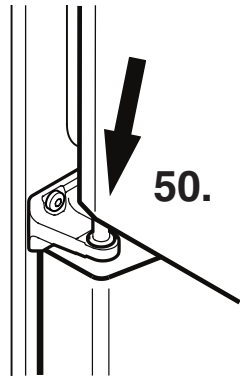

55. Pull the right-hand side of the cover approx. 1/4" (6 mm) towards you.

56. Move soft stop mechanism hinge to the fastener and insert pin.

57. Remove red safety bracket.

IMPORTANT

The door must now be held secure by another person.

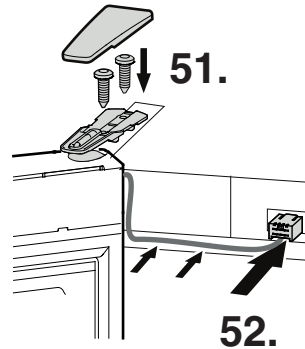
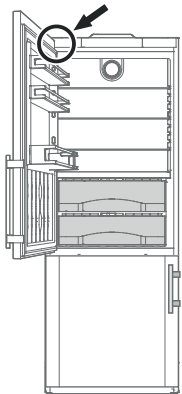

51. Secure door with screws and click cover into place.

52. Plug in the connector and insert the cable in the guide.

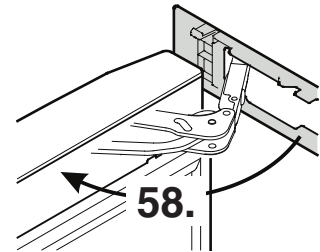
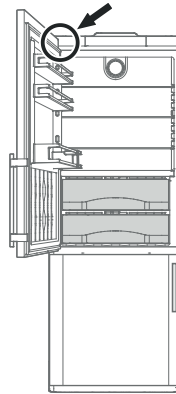

58. Pivot door cover to the left and click into place on the door.

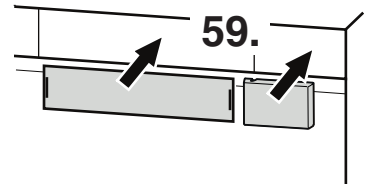
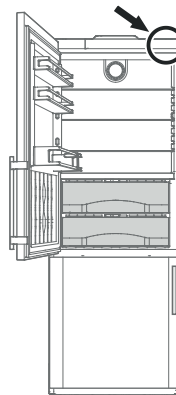

59. Click covers into place.

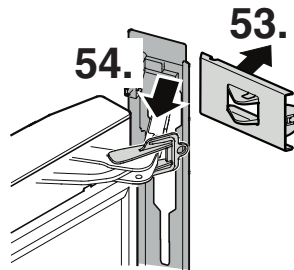
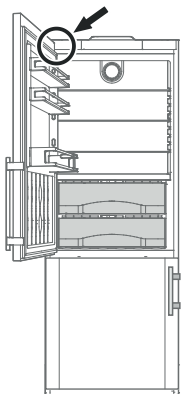

53. Click cover into place.

54. Slide door cover over soft stop mechanism hinge.

60. Place the appliance in its final position at the place of installation.

Extend the adjustable foot at the bottom hinge bracket until it rests on the floor and then make a further 90° turn.

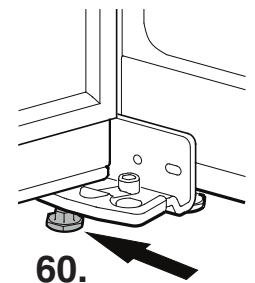

For Service in the U.S.

Liebherr Service Center

Toll Free: **1-866-LIEBHER** or **1-866-543-2437**

Email: Service-appliances.us@liebherr.com

PlusOne Solutions, Inc.

3501 Quadrangle Blvd, Suite 120

Orlando, FL 32817

For Service in Canada

Liebherr Service Center

Toll Free: **1-888-LIEBHER** or **1-888-543-2437**

www.euro-parts.ca

EURO-PARTS CANADA

39822 Belgrave Road

Belgrave, Ontario, N0G 1E0

Phone: (519) 357-3320

Fax: (519) 357-1326



www.liebherr-appliances.com