

# MULTI F

# MULTI F MAX

## HEAT PUMP SYSTEM ENGINEERING MANUAL

### Multi-Zone Heat Pump Systems 1.5 to 4.5 Tons



Dual and Tri-Zone  
Multi F



Quad-Zone  
Multi F



Eight-Zone  
Multi F MAX

# **PROPRIETARY DATA NOTICE**



**This document, as well as all reports, illustrations, data, information, and other materials are the property of LG Electronics U.S.A., Inc., and are disclosed by LG Electronics U.S.A., Inc., only in confidence.  
This document is for design purposes only.**

DFS-EM-AJ-001-US 014C25

For continual product development, LG reserves the right to change specifications without notice.  
©LG Electronics Inc.

About LG Electronics, Inc.....	4	Multi F MAX Branch Distribution Unit Product Data .....	169-178
Multi-Zone Systems.....	4	Features and Benefits .....	170
Unit Nomenclature.....	6	Mechanical Specifications .....	171
Outdoor Unit Overview .....	7	General Data .....	172
Indoor Unit Overview .....	8	Dimensions.....	173
Controls and Options Overview .....	9-13	Refrigerant Flow Diagram.....	174
Multi F Outdoor Unit Product Data .....	15-124	Wiring Diagram.....	175
Product Features and Benefits .....	16	Y-Branch Accessory.....	176
Mechanical Specifications .....	17	Branch Distribution Unit Orientation .....	177
General Data .....	18-19	Application Guidelines.....	179-196
Dimensions.....	20-22	Equipment Selection Procedure .....	180-185
Rated Cooling Combination Tables .....	23-25	Building Ventilation Design Guide .....	186-189
Rated Heating Combination Tables .....	26-28	Placement Considerations.....	190-196
Cooling Capacity Tables .....	29-80	Refrigerant Piping Design & Layout Best Practices .....	197-218
Heating Capacity Tables.....	81-115	Design Guideline Summary.....	198-199
Electrical Data .....	116	Creating a Balanced / Quality Piping System.....	200
Acoustic Data .....	116	Manual Layout Procedure .....	200
Refrigerant Flow Diagrams.....	117-119	LG Engineered Multi F MAX Y-Branch Kits .....	201
Wiring Diagrams.....	120-122	Refrigerant Charge .....	202-203
Operation Range .....	123	Selecting Field-Supplied Copper Tubing .....	204-205
Multi F MAX Outdoor Unit Product Data .....	125-168	Refrigerant Piping System Layout.....	206-213
Product Features and Benefits .....	126	Piping Insulation .....	214
Mechanical Specifications .....	127	Condensate Drain Piping.....	215-216
General Data .....	128-129	Cut Sheet.....	217
Dimensions.....	130	Wiring Connections.....	219
Rated Cooling Combination Tables .....	131-133	General Information.....	220-222
Rated Heating Combination Tables .....	134-135	Power Wiring and Communications Cable Details .....	223-227
Cooling Capacity Tables .....	137-153	Indoor Unit Group Control .....	228
Heating Capacity Tables.....	154-164	Acronyms .....	229
Electrical Data .....	165		
Acoustic Data .....	165		
Refrigerant Flow Diagrams.....	166		
Wiring Diagrams.....	167		
Operation Range .....	168		

TABLE OF SYMBOLS

 <b>WARNING</b>	This symbol indicates a potentially hazardous situation which, if not avoided, may result in death or serious injury.
<b>Note</b>	This symbol indicates additional helpful information such as an explanation, a comment, or a clarification about the subject.
	This symbol indicates a recommendation or tip. Recommendations instruct the user to apply the suggested practice to ensure the best operating results in order to achieve the maximum benefit of the product. Tips contain practical information that may help the user solve a problem or describe actions that may save time.

# CONVERGENCE OF TECHNOLOGY, INNOVATION, FLEXIBILITY, & STYLE



## About LG Electronics, Inc.

LG Electronics, Inc. is a global leader and technology innovator in consumer electronics, mobile communications, and home appliances, employing more than 213,000 people in more than 60 countries worldwide. LG Electronics, Inc. comprises five business units—Home Entertainment, Mobile Communications, Air Conditioning, Business Solutions, and Home Appliance. LG is one of the world's leading producers of flat panel televisions, audio and video products, mobile handsets, air conditioners, and washing machines. LG's commercial air conditioning business unit was established in 1968 and has built its lineup of residential and commercial products to include VRF, Multi F, duct-free split systems, packaged terminal air conditioners (PTACs), and room air conditioners. In 2011, the air conditioning and energy solutions business unit grew to include LED lighting and solar products. For more information, visit [www.lg-dfs.com](http://www.lg-dfs.com).

## Multi-Zone Systems

LG HVAC systems offer a range of solutions that are cost efficient, quiet and attractive. Multi-zone systems are "split" into indoor and outdoor units, and provide a smart alternative to both central HVAC and window-mounted air conditioners. These inverter heat pump systems are available in a variety of configurations to suit different cooling and heating situations. Installation by a qualified HVAC contractor is safe and easy – little to no duct work or sheet metal is required.

### Benefits of Multi F Systems

- Individual zone control
- Long refrigerant piping lengths
- High refrigerant piping elevation differences
- Maximum flexibility
- Operating ranges of 14°F to 118°F in cooling and 0°F to 64°F in heating
- Quiet and comfortable environment
- Reduced ductwork



## Multi F Systems

LG's inverter heat pumps can support two, three, or four indoor units that are typically installed in separate rooms. Each indoor unit includes its own remote control, allowing the customer to set the temperature individually. Indoor units are available in several different configurations: Art Cool™ Mirror wall-mounted, Art Cool Gallery wall-mounted, standard wall-mounted, four-way ceiling cassettes, ceiling-concealed duct (high and low static), and vertical-horizontal air handling models. Multi F MAX systems, released in 2012, can operate up to eight indoor units through two-, three-, or four-port branch distribution units.

## Adaptable and Flexible

Multi F outdoor units can be adapted to a wide range of building applications and sizes such as schools, hotels, hospitals, offices, and residences. The system components are lightweight and compact so they can be placed in buildings without expensive cranes, they easily fit into most service elevators, and they can be set in place with minimal structural reinforcements requirements.

Multi F technology allows you to pipe farther by reaching areas of the building that would require the installation of a second system when using traditional direct-expansion cooling and heating equipment. Multi F provides the designer with uncompromised pipe system engineering flexibility—long pipe runs and large elevation differences. Whether your building is a condominium, a hotel, a school, or an office complex, Multi F is best suited to reach the farthest corners and elevations.

## Smaller Chases and Plenums

LG Multi F systems use refrigerant piping to move heat, resulting in smaller space requirements for piping as compared to chilled water or roof top systems. This helps reduce the overall construction and material cost of the building, and gives back leasable space. Flexible and logical placement of system components, reduced back-and-forth pipe lengths, and fewer joints lowers installation costs and minimizes potential leaking.

## Quality Commitment

LG is committed to the success of DFS projects. We provide technical support during installation and commissioning. LG offers a variety of classes designed for installers and servicers on Multi F installation. Classes are conducted at LG's training centers and in field locations at various times throughout the year and upon special request.



# MULTI F



# PRODUCT INTRODUCTION

**“Unit Nomenclature” on page 6**

**“Outdoor Unit Overview” on page 7**

**“Indoor Unit Overview” on page 8**

**“Controls and Options Overview” on page 9**

## Multi-Zone Systems — Indoor Units and Outdoor Units

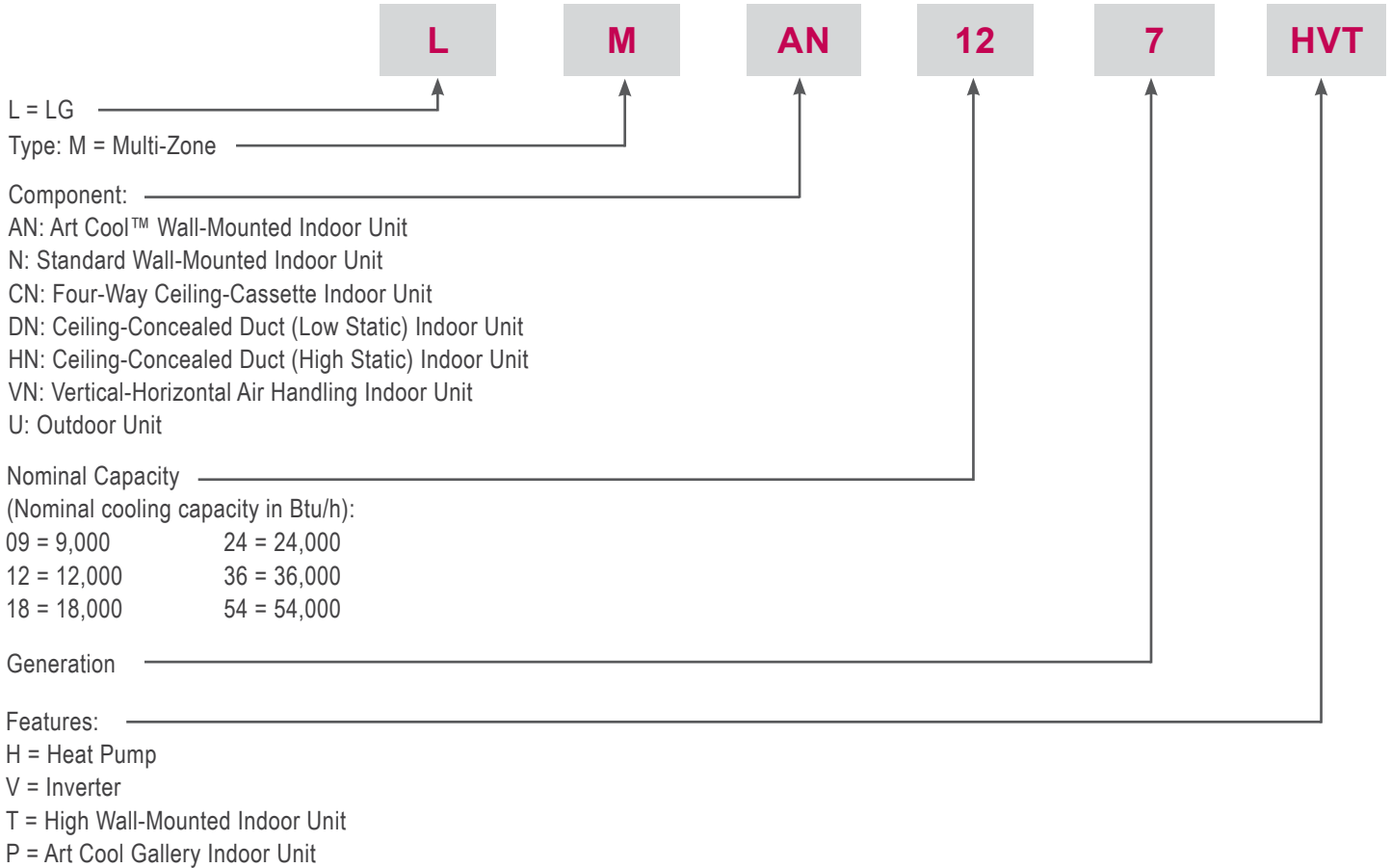

## Branch Distribution Units

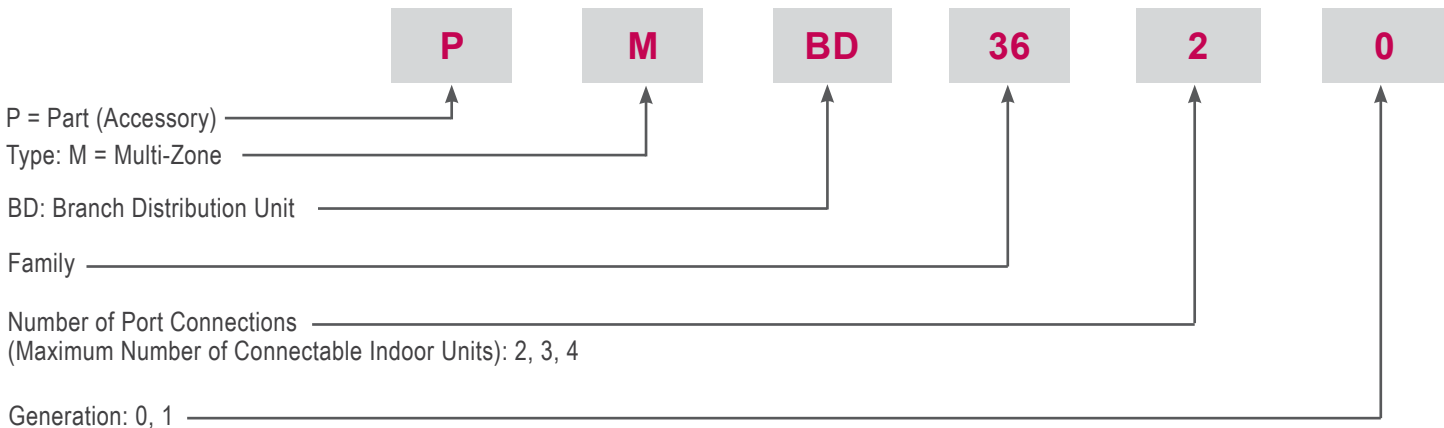

### Note:

- Voltage for all equipment is 208-230V, 60 Hz, 1-phase.
- All indoor units are compatible with wired controllers
- All outdoor units are LGAP control network compatible with PI-485 V-net Control Integration Board (PMNFP14A0, sold separately).

Table 1: Summary Data—Multi F / Multi F MAX Outdoor Units

Outdoor Unit Type	Model Number <sup>1</sup>	Dimensions (W x H x D) (inches)	Nominal Cooling Capacity Btu/h <sup>2</sup>	Net Weight (lbs.)	No. of Connectable Indoor Units <sup>3</sup>	Pipe Connections (inches, O.D.) (Liquid, Vapor)
 <p>Multi F Dual-Zone</p>	LMU187HV	34-1/4 x 31-13/16 x 12-19/32	18,000	124	2-2	1/4 x 2 Each, 3/8 x 2 Each
 <p>Multi F Tri-Zone</p>	LMU247HV	34-1/4 x 31-13/16 x 12-19/32	24,000	131	2-3	1/4 x 3 Each, 3/8 x 3 Each
 <p>Multi F Quad-Zone</p>	LMU369HV	35-7/16 x 45-7/8 x 14-9/16	36,000	199	2-4	1/4 x 4 Each, 3/8 x 4 Each
 <p>Multi F MAX Eight-Zone</p>	LMU540HV	37-13/32 x 54-11/32 x 13	54,000	214	2-8	3/8 x 1 Each, 3/4 x 1 Each

<sup>1</sup>Model number shows nominal capacity and frame size designator.

<sup>2</sup>Nominal capacity rating obtained with air entering the indoor unit at 80°F dry bulb (DB) and 67°F wet bulb (WB) and outdoor ambient conditions of 95°F dry bulb (DB) and 75°F wet bulb (WB).

<sup>3</sup>Minimum number of connectable indoor units is two (2).

# INDOOR UNIT OVERVIEW

**MULTI F**  
**MULTI F MAX**

Table 2: Summary Data—Multi F Indoor Units.







Indoor Unit Type	Model Number <sup>1</sup>	Dimensions (W x H x D) (inches)	Nominal Cooling Capacity Btu/h <sup>2</sup>	Air Flow Rate (CFM) (H/M/L <sup>3</sup> )	Net Weight (lbs.)	Pipe Connections (inches, O.D.) (Liquid, Vapor)
Art Cool™ Mirror Wall-Mounted 	LMAN097HVT	35-1/4 x 11-3/8 x 8-1/16	9,000	247 / 230 / 212	25	1/4, 3/8
	LMAN127HVT		12,000	335 / 318 / 300		
	LMAN187HVT	40-9/16 x 12-25/32 x 9-21/32	18,000	572 / 501 / 434	35	1/4, 1/2
Art Cool™ Gallery Wall-Mounted 	LMAN097HVP	23-5/8 x 23-5/8 x 5-25/32	9,000	272 / 208 / 155	32	1/4, 3/8
	LMAN127HVP		12,000	314 / 258 / 198		
Standard Wall-Mounted 	LMN097HVT	35-1/4 x 11-3/8 x 8-9/32	9,000	247 / 230 / 212	23	1/4, 3/8
	LMN127HVT		12,000	335 / 318 / 300		
	LMN187HVT	40-9/16 x 12-25/32 x 9-27/32	18,000	572 / 501 / 434	32	1/4, 1/2
Ceiling-Concealed Duct (Low Static) 	LMDN095HV	32-9/32 x 7-1/2 x 22-5/8	9,000	300 / 265 / 229	46	1/4, 3/8
	LMDN125HV		12,000	335 / 300 / 265		
	LMDN185HV	43-5/16 x 7-1/2 x 22-5/8	18,000	530 / 477 / 406	59	1/4, 1/2
Ceiling-Concealed Duct (High Static) 	LMHN240HV	46-17/32 x 11-23/32 x 17-23/32	24,000	688 / 618 / 530	80	1/4, 1/2
	LMHN360HV		36,000	1,130 / 953 / 706	91	3/8, 5/8
Four-Way Ceiling Cassette 	LMCN125HV	Body: 22-7/16 x 8-7/16 x 22-7/16 Panel: 27-9/16 x 7/8 x 27-9/16	12,000	335 / 283 / 247	31 (Body), 7 (Panel)	1/4, 3/8
	LMCN185HV	Body: 22-7/16 x 10-3/32 x 22-7/16 Panel: 27-9/16 x 7/8 x 27-9/16	18,000	459 / 424 / 388	34 (Body), 7 (Panel)	1/4, 1/2
Vertical-Horizontal Air Handling 	LMVN240HV	18 x 48-21/32 x 21-1/4	24,000	710 / 640 / 480	117	1/4, 1/2
	LMVN360HV		36,000	990 / 880 / 800	121	3/8, 5/8

<sup>1</sup>Model number shows nominal capacity and frame size designator.

<sup>2</sup>Nominal capacity rating obtained with air entering the indoor unit at 80°F dry bulb (DB) and 67°F wet bulb (WB) and outdoor ambient conditions of 95°F dry bulb (DB) and 75°F wet bulb (WB).

<sup>3</sup>H/M/L = High/Medium/Low.

Table 3: Summary Data—Zone Controllers.

Zone Controller	Name	Model / Part No.	Case Color	Max. Wire Length (ft.)	Description
	Simple Controller with Mode Selection	PQRCVCL0	Black	164	Allows control of indoor unit ON / OFF, operation mode, fan speed, and temperature setpoint for up to 16 indoor units. Included with Ceiling-Concealed Duct (High Static <sup>1</sup> ) and Vertical-Horizontal Air Handling <sup>1</sup> indoor units; optional accessory for all other indoor unit types.
		AKB72955816 <sup>1</sup>	White		
	Simple Controller with Mode Selection	6711A20116R <sup>2</sup>	White	164	Allows control of indoor unit ON / OFF, operation mode, fan speed, and temperature setpoint for up to 16 indoor units. Included with Ceiling-Concealed Duct (Low Static <sup>2</sup> ) indoor units; optional accessory for all other indoor unit types.
	Simple Controller without Mode Selection	PQRCHCA0	Black	164	Allows control of indoor unit ON / OFF, fan speed, and temperature setpoint for up to 16 indoor units.
		PQRCHCA0QW	White		
	LG 7-Day Programmable Thermostat	PREMTB10U	White	164	Allows control of indoor unit ON / OFF, operation mode, occupied / unoccupied temperature setpoints, fan speed, and airflow direction for up to 16 indoor units. Programmable schedule with five events per day.
	Wireless Handheld Controller	AKB73635606 <sup>3</sup> AKB73635607 <sup>4</sup> AKB73757604 <sup>5</sup>	Ivory	-	Allows control of indoor unit ON / OFF, operation mode, fan speed, and temperature setpoint. Also provides subfunction control. Included with Art Cool Mirror <sup>3</sup> and Gallery <sup>4</sup> Wall-Mounted, Standard <sup>3</sup> Wall-Mounted, and Four-Way Cassette <sup>5</sup> indoor units; optional accessory for Duct and Vertical-Horizontal AHU with use of wired controller.
	Wall-Mounted Remote Temperature Sensor	PQRSTA0	Ivory	50	Allows remote temperature measurement for four-way ceiling cassette, ceiling-concealed duct, and vertical-horizontal air handling indoor units.

<sup>1</sup>Simple Mode Controllers for the ceiling-concealed duct (high static) and the vertical-horizontal air handling indoor units are also referenced by Model No. PQRCVCL0QW.



<sup>2</sup>Simple Mode Controllers for the ceiling-concealed duct (low static) indoor units are also referenced by Model No. PQRCUCS0C.

<sup>3</sup>Wireless Handheld Controller for the four-way ceiling cassette indoor units is also referenced by Model No. PQWRHQ0FDB.

Before specifying or placing an order, refer to the V-Net Network Solutions Engineering Product Data Book, and review the detailed technical data provided to fully understand the capabilities and limitations of these devices.

For information on controller capabilities, refer to the Controls and Options Table on page 12.



Table 4: Summary Data—Zone Controller Communication Cables.

Communication Cable	Name	Model No.	Max. Wire Length (ft.)	Description
	Wired Remote Group Control Cable Assembly	PZCWRCG3	32	Required when grouping multiple indoor units with a single zone controller.
	Wired Remote / Group Control Extension Cable	PZCWRC1	32	Increases the distance between a remote controller and an indoor unit, or between indoor units in a control group.

Before specifying or placing an order, refer to the V-Net Network Solutions Engineering Product Data Book, and review the detailed technical data provided to fully understand the capabilities and limitations of these devices.

For information on controller capabilities, refer to the Controls and Options Table on page 12.



Table 5: Summary Data—Specialty Application Devices.

Specialty Application Device	Name	Model No.	Connects to	Application	Binary Signals Input / Output	Description
	Dry Contact Unit 24 VAC	PQDSB1	Indoor Unit	ON / OFF, Run Status, Error Status	1 / 2	Enables the indoor unit to be controlled and monitored by third-party controls using binary inputs and outputs.
	Dry Contact Unit for Setback	PQDSBC		ON / OFF, Mode, Controller Lock, Power Save, Run Status, Error Status	2 / 2	
	Dry Contact Unit for Thermostat	PQDSBNGCM1		ON / OFF, Thermo ON / OFF, Mode, Fan Speed, Run Status, Error Status	—	Enables the indoor unit to be controlled and monitored by a third-party thermostat or controller.
	PI-485 V-net Control Integration Board	PMNFP14A0	Outdoor Unit	—	—	Control integration to LG V-net controls (AC Smart Premium, ACP, BACnet, LonWorks, etc.)
	Power Distribution Indicator (PDI) Premium	PQNUD1S41	Comm. BUS	Energy Consumption Monitoring	8 / 0	Monitors total outdoor unit power consumption for up to eight systems, and distributes per indoor unit based on weighted calculation.

Before specifying or placing an order, refer to the V-Net Network Solutions Engineering Product Data Book, and review the detailed technical data provided to fully understand the capabilities and limitations of these devices.

For information on controller capabilities, refer to the Controls and Options Table on page 12.



Table 6: Summary Data—Central Controllers (Connect to the Outdoor Unit Through the PI-485 Board (accessory, sold separately)).

Central Controller	Name	Model No.	Devices per Controller	Systems per Comm. BUS	Devices per Comm. BUS	No. of Comm. BUS ports	Binary Signals Input / Output	Power / Connection	Description
	AC Smart Premium	PQCSW421E0A	128	16	128	1	2 DI / 2 DO	24 VAC	Provides for scheduling, auto-changeover, setback, remote controller lock, setpoint range limit, run time limit, web access, email alarm notification, visual floorplan navigation, peak/demand control, software device interlocking, PDI integration, and AC Manager Plus integration advanced functionality in addition to basic unit control and monitoring.
	AC Ez	PQCSZ250S0	32	16	256	1	—	12 VDC / Outdoor Unit	Provides for scheduling in addition to basic indoor unit control and monitoring.
	Advanced Control Platform (ACP) Standard	PQCPC22N1	256	16	64 (128 with PDI Premium)	4	2 / 2	24 VAC	Provides for scheduling, remote controller lock, setpoint range limit, web access, peak / demand control, PDI integration, and AC Manager Plus integration advanced functionality in addition to basic unit control and monitoring.
	Advanced Control Platform (ACP) Premium	PQCPC22A1	256	16	64 (128 with PDI Premium)		10 / 4	24 VAC	

Before specifying or placing an order, refer to the V-Net Network Solutions Engineering Product Data Book, and review the detailed technical data provided to fully understand the capabilities and limitations of these devices.

For information on controller capabilities, refer to the Controls and Options Table on page 12.

Table 7: Summary Data—Integration Solutions (Connect to Outdoor Unit Through the PI-485 Board (accessory, sold separately)).

Central Controller	Name	Model No.	Devices per Controller	Systems per Comm. BUS	Devices per Comm. BUS	No. of Comm. BUS ports	Binary Signals Input / Output	Power / Connection	Description
	BACnet® Gateway	PQNFB17C1	256	16	64 (128 with PDI Premium)	4	2 / 2	24 VAC	Allow integration of LG equipment for control and monitoring by open protocol BACnet and LonWorks building automation and controls systems.
	LonWorks® Gateway	PLNWKB100	64	16	64 (128 with PDI Premium)	1	2 / 2	24 VAC	

Before specifying or placing an order, refer to the V-Net Network Solutions Engineering Product Data Book, and review the detailed technical data provided to fully understand the capabilities and limitations of these devices.

For information on controller capabilities, refer to the Controls and Options Table on page 12.

# CONTROLS AND OPTIONS OVERVIEW

MULTI F  
MULTI F MAX

Table 8: Indoor Units—Functions, Controls and Options.

Indoor Unit Type		ART COOL™ Mirror Wall Mounted	ART COOL™ Gallery	Standard Wall Mounted	Ceiling Concealed (Low Static) Ducted	Ceiling Concealed (High Static) Ducted	Four-Way Ceiling Cassette	Vertical- Horizontal Air Handling Unit
Airflow	Air supply outlets	1	3	1	1	2	4	1
	Airflow direction (left/right)	Auto	Auto	Auto				
	Airflow direction (up/down)	Auto	Auto	Auto			Auto	
	Auto swing (left/right)	√	√	√				
	Auto swing (up/down)	√	√	√			√	
	Airflow steps (fan/cool/heat)	6 / 6 / 6	5 / 5 / 5	6 / 6 / 6	3 / 3 / 3	3 / 3 / 3	4 / 5 / 4	3 / 3 / 3
	Chaos wind (random fan speed)	√	√	√			√	
	Jet-cool/heat	√ / √	√ / √	√ / √			√ / -	
	Swirl wind						√	
Washable anti-fungal <sup>1</sup>		√	√	√	√	√	√	
	Plasma <sup>2</sup>	√		√			o <sup>3</sup>	
	Ventilation						√ <sup>4</sup>	
Operation	Drain pump				√	√	√	
	E.S.P. control				√	√		√
	Electric heater							o
	High ceiling						√	
	Hot Start	√	√	√	√	√	√	√
	Self diagnostics	√	√	√	√	√	√	√
	Soft Dry (dehumidification)	√	√	√	√	√	√	√
	Auto operation	√	√	√	√	√	√	√
	Auto clean (coil dry)	√	√	√				
	Auto restart	√	√	√	√	√	√	√
	Child lock	o	o	o	o	o	o	o
	Forced operation	√	√	√			√	
	Group control – Requires the use of one Group control Cable Kit (PZCWRCG3) for every additional indoor unit	o	o	o	o	o	o	o
	Sleep mode	√	√	√	√	√	√	√
	Timer (on/off)	√	√	√			√	√
Weekly schedule	o	o	o			√	√	
Two thermistor control	o	o	o	o	o	o	o	
Controllers	7-Day programmable controller	o	o	o	o	o	o	o
	Simple wired remote controller	o	o	o	√	√	o	o
	Wireless LCD remote control	√	√	√	o <sup>5</sup>	o <sup>5</sup>	√	o <sup>5</sup>
	Dry contact	o	o	o	o	o	o	o
	Dry contact (temperature setting)	o	o	o	o	o	o	o
	Central control (LGAP)	√	√	√	√	√	√	√
	Connector for Water Sensor	√	√	√				

<sup>1</sup>Primary washable filters.

<sup>2</sup>Secondary plasma filters.

<sup>3</sup>Branch location and static pressure requirements. Requires PTPKQ0 Plasma kit.

<sup>4</sup>Requires ventilation kit PTVK430 (Temperature, humidity, and volume limitations apply).

<sup>5</sup>Requires wired zone controller.

√ = Standard feature

o = Unit option

Table 9: Multi F MAX Outdoor Unit Accessories Overview.



Multi F MAX Accessory	Name	Model No.	Description
	Two-Port Branch Distribution Unit	PMBD3620	Distributes refrigerant from Multi F MAX outdoor unit from one (1) to two (2) indoor units (maximum 24,000 Btu/h for each port).
	Three-Port Branch Distribution Unit	PMBD3630	Distributes refrigerant from Multi F MAX outdoor unit from one (1) to three (3) indoor units (maximum 24,000 Btu/h for each port).
	Four-Port Branch Distribution Unit	PMBD3640	Distributes refrigerant from Multi F MAX outdoor unit from one (1) to four (4) indoor units (maximum 24,000 Btu/h for each port).
		PMBD3641	Distributes refrigerant from Multi F MAX outdoor unit from one (1) to four (4) indoor units (maximum 24,000 Btu/h for ports A,B,C; maximum 36,000 Btu/h for D port).
<p>Ø3/4 Gas</p>  <p>Ø3/8 Liquid</p>	Y-branch Kit	PMBL5620	Y-branch Kit for Multi F MAX outdoor unit to connect up to two (2) branch distribution units.

Table 10: Indoor Unit Accessories Overview.

Model No.	Description
<i>For Four-Way Ceiling-Cassette Indoor Units</i>	
PT-UQC	Ceiling Grille
PTPKQ0	Plasma Kit
PTVK430	Ventilation Kit
<i>For Vertical-Horizontal Air Handling Units</i>	
ANEH053B1	5 kW Electric Heater
ANEH103B2	10 kW Electric Heater
<i>For Ceiling-Concealed Duct (High Static) Indoor Units</i>	
ZFBXBG01A	High Efficiency Filter Box
ZFBXD201A	Dynamic V8 2VL Low Profile Air Cleaner
ZPLMV201A	Dynamic 2VL Air Cleaner Low Profile Return Air Plenum
ZFBXD402A	Dynamic V8 4VL Low Profile Air Cleaner
ZPLMV402A	Dynamic 4VL Air Cleaner Low Profile Return Air Plenum
ZFLT1301A	4-Pack Dynamic V8 VL Air Cleaner Replacement Filter Pads
ZFLT1302A	24-Pack Dynamic V8 VL Air Cleaner Replacement Filter Pads
ZGRLRA01A	Dynamic V8 Air Cleaner Louvered Return Air Grille (one per plenum )
ZGRLRA02A	Dynamic V8 Air Cleaner Egg Crate Return Air Grille (one per plenum)

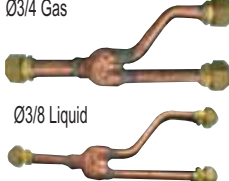

# MULTI F OUTDOOR UNIT DATA

**“Product Features and Benefits” on page 16**

**“Mechanical Specifications” on page 17**

**“General Data” on page 18**

**“Dimensions” on page 20**

**“Rated Cooling Combination Tables” on page 23**

**“Rated Heating Combination Tables” on page 26**

**“Cooling Capacity Tables” on page 29**

**“Heating Capacity Tables” on page 81**

**“Electrical Data” on page 116**

**“Acoustic Data” on page 116**

**“Refrigerant Flow Diagrams” on page 117**

**“Wiring Diagrams” on page 120**

**“Operation Range” on page 123**

# MULTI F SYSTEMS

## Features and Benefits

MULTI F  
MULTI F MAX

The multiple piping of Multi F systems can support two, three or four indoor units that are typically mounted in separate rooms. Compact refrigerant pipes work in tandem with wiring to link the outdoor unit with all indoor units directly. Most indoor units include its own remote control, allowing the user to set the temperature individually in different rooms. The indoor units are available in a variety of capacities and styles, including Art Cool™ Mirror and Gallery Wall Mounts, Standard Wall Mount, Four-Way Ceiling Cassette, Horizontal Ceiling Concealed Duct, and Vertical-Horizontal Air Handling models.

### Features

- Defrost
- Restart delay (three [3] minutes)
- Self diagnosis
- Soft start
- Inverter (Variable speed compressor)
- Low ambient operation to 14°F (Cooling mode)
- Auto operation / auto restart operation
- Gold Fin™ anti-corrosion
- Outdoor unit includes sufficient refrigerant for charging two (2), three (3), or four (4) indoor units using 24.6 feet of pipe to each

### Benefits

- Long refrigerant piping lengths allow for extra design flexibility in indoor unit placement
- Easy installation: Little to no ductwork required; most indoor units can mount on any wall
- Indoor unit and outdoor unit dimensions ensure space saving convenience
- All-season use—heat pump models have both cooling and heating capabilities



Figure 1: Dual-Zone Multi F Heat Pump Inverter System — Mix and match for 9,000-24,000 Btu/h.



Figure 2: Tri-Zone Multi F Heat Pump Inverter System — Mix and match for 12,000-33,000 Btu/h.



Figure 3: Quad-Zone Multi F Heat Pump Inverter System — Mix and match for 18,000-48,000 Btu/h.

**Multi F Heat Pump Condensing Units**

**General**

A Multi F multi-zone system is comprised of one heat pump outdoor unit connected to two, three, or four indoor units using a shared refrigerant piping circuit between the outdoor unit and each indoor unit, and includes integrated controls supplied by LG. The outdoor unit is internally assembled, wired, and piped from the factory; all LG components are manufactured in a facility registered to ISO 9001 and ISO 14001, set by the International Organization for Standardization (ISO). The LG Multi F multi zone heat pump system components comply with Underwriters Laboratories (UL) 1995 Heating and Cooling Equipment Standard for Safety, and bear the Electrical Testing Laboratories (ETL) mark. The units are certified to AHRI 210 / 240.

**Temperature Ranges**

The heat pump outdoor units are capable of operating in cooling mode from 14°F to 118°F ambient dry bulb. The heat pump outdoor units are capable of operating in heating mode from 0°F to 64°F ambient wet bulb without additional low ambient controls.

**Frame**

The Multi F condensing unit case is constructed from pre-coated metal that has been tested in accordance with ASTM B-117 salt spray procedure for a minimum of 1,000 hours. Case has a removable front panel to allow access to major components and control devices, and legs to secure the unit during installation.

**Refrigerant System**

Multi F systems have a shared refrigerant circuit field piped to multiple (ducted, non-ducted or mixed) indoor units to effectively and efficiently control the heating or cooling operation of the multi zone system. All refrigerant lines from the outdoor unit to the indoor units are field-installed and must be insulated separately.

All Multi F systems use R410A refrigerant. The outdoor units are equipped with a refrigerant strainer, check valves, oil separator, accumulator, four-way reversing valve, electronic expansion valve(s) (EEV), high side and low side refrigerant charging ports, and a service port. Each outdoor unit also includes sensors for suction temperature, discharge temperature, high-pressure, low-pressure, heat exchanger temperature, and outdoor temperature conditions.

**Refrigeration Oil Control**

The outdoor units have an oil separator to separate oil mixed with the refrigerant gas during compression and return oil to the compressor. The outdoor units also have an oil injection mechanism to ensure a consistent film of oil on all moving compressor parts at low speed.

**Compressor**

Multi F condensing units are equipped with one hermetically sealed, digitally controlled, inverter driven twin-rotary compressor that includes Teflon™ coated bearings. The inverter motor is capable of providing a modulation range of 20Hz to 100Hz with control in

Figure 4: Multi F LMU187HV and LMU247HV Outdoor Units.



Figure 5: Multi F LMU369HV Outdoor Unit.



1Hz increments. The compressor is protected with phase-reversal protection, uses a factory-charge of Polyvinyl Ether (PVE) oil, and is mounted to avoid the transmission of vibration. Compressors in LMU369HV models are equipped with a hot gas bypass valve.

**Fan and Motors**

Each 1.5 to 2 ton outdoor unit includes one direct drive variable speed propeller fan with Brushless Digitally Controlled (BLDC) motor with a horizontal air discharge. Each 3 ton outdoor unit includes two direct drive variable speed propeller fans with Brushless Digitally Controlled (BLDC) motor with a horizontal air discharge.

Fan blades are statically and dynamically balanced propeller fans made of durable Acrylonitrile Butadiene Styrene (ABS) plastic, and include a raised fan guard to limit contact with moving parts. The motors have inherent overload protection, permanently lubricated bearings, and a maximum speed up to 950 rpm. All Multi F outdoor units have a horizontal discharge airflow.

**Outdoor Unit Coil**

The outdoor unit coils are factory-built of aluminum fins mechanically bonded on copper tubing. Coils have a minimum of two rows, a minimum of 14 fins per inch, and have been factory pressure-tested. Coil fins also have a factory applied corrosion-resistant GoldFin™ material with hydrophilic coating that has been tested in accordance with ASTM B-117 salt spray test procedure for a minimum of 1,000 hours.

**Electrical**

All Multi F outdoor units shall have 208/230V, 1 phase, 60Hz electrical power capable of operating within ±10% of the rated voltage.

**Controls**

Factory installed microprocessor controls in the outdoor unit and indoor units shall perform functions to efficiently operate the multi zone system. System wiring must be installed in a tree configuration from outdoor unit to indoor units through four conductor power/transmission cable. The system is capable of performing continuous operation, even when power is turned off to an individual indoor unit.

# MULTI F OUTDOOR UNIT

## General Data

MULTI F  
MULTI F MAX

Table 11: Multi F Outdoor Unit Specifications.

Model Number	LMU187HV	LMU247HV	LMU369HV
Rated Cooling Capacity (Btu/h) <sup>1</sup>	15,600	19,200	34,000
Rated Heating Capacity (Btu/h) <sup>1</sup>	17,000	26,400	41,000
<b>Operating Range</b>			
Cooling (°F DB)	14 - 118	14 - 118	14 - 118
Heating (°F WB)	0 - 64	0 - 64	0 - 64
<b>Compressor</b>			
Inverter Quantity	Twin Rotary x 1	Twin Rotary x 1	Twin Rotary x 1
Oil/Type	FVC68D	FVC68D	FVC68D
<b>Fan (Side Discharge)</b>			
Type	Propeller	Propeller	Propeller
Motor Output (W) x Qty.	84 x 1	84 x 1	124 x 2
Motor/Drive	Brushless Digitally Controlled/Direct		
Maximum Air Volume (CFM)	2,119	2,119	2,119 x 2
<b>Unit Data</b>			
Refrigerant Type	R410A	R410A	R410A
Refrigerant Control/Location	EEV/Outdoor Unit	EEV/Outdoor Unit	EEV/Outdoor Unit
Min. Number Indoor Units/System <sup>2</sup>	2	2	2
Max. Number Indoor Units/System <sup>2</sup>	2	3	4
Maximum Allowable Total Indoor Unit Connected Capacity (Btu/h)	24,000	33,000	48,000
Sound Pressure dB(A) <sup>3</sup>	51	51	57
Net Unit Weight (lbs.)	124	131	199
Shipping Weight (lbs.)	133	139	217
Power Wiring / Communication Cables <sup>4</sup> (No. x AWG)	4 x 18	4 x 18	4 x 18
<b>Heat Exchanger</b>			
Material and Fin Coating	Copper Tube/Aluminum Fin and GoldFin™/Hydrophilic		
Rows/Columns/Fins per inch x Qty.	(2 x 36 x 16) x 1	(2 x 36 x 16) x 1	(2 x 26 x 17) x 2
<b>Piping</b>			
Liquid Line Connection (in., OD) x Qty.	1/4 x 2	1/4 x 3	1/4 x 4
Vapor Line Connection (in., OD) x Qty.	3/8 x 2	3/8 x 3	3/8 x 4
Factory Charge lbs. of R410A	4.19	4.63	7.72
<b>Piping Lengths</b>			
Maximum Total Piping (ft) <sup>5</sup>	164.0	246.1	246.1
Maximum Outdoor Unit to Indoor Unit Piping (ft)	82.0	82.0	82.0
Piping Length (No Additional Refrigerant [ft])	49.2	73.8	98.4
Maximum Elevation between Outdoor Unit and Indoor Unit (ft)	49.2	49.2	49.2
Maximum Elevation between Indoor Unit and Indoor Unit (ft)	24.6	24.6	24.6

<sup>1</sup>Rated capacity applied with non-ducted indoor units, and is rated 0 ft. above sea level with 25 ft. of refrigerant line per indoor unit and a 0 ft. level difference between outdoor and indoor units. All capacities are net with a combination ratio between 95 – 105%.

Rated cooling capacity obtained with air entering the indoor unit at 80°F dry bulb (DB) and 67°F wet bulb (WB) and outdoor ambient conditions of 95°F dry bulb (DB) and 75°F wet bulb (WB).  
Rated heating capacity obtained with air entering the indoor unit at 70°F dry bulb (DB) and 60°F wet bulb (WB) and outdoor ambient conditions of 47°F dry bulb (DB) and 43°F wet bulb (WB).

<sup>2</sup>At least two indoor units should be connected. For allocated capacity information, see the combination tables on pages 23 to 28.

<sup>3</sup>Sound pressure levels are tested in an anechoic chamber under ISO Standard 3745 and are the same in both cooling and heating mode. These values can increase due to ambient conditions during operation.

<sup>4</sup>All power wiring / communication cable to be minimum 18 AWG, 4-conductor, stranded, shielded, and must comply with applicable local and national codes. For detailed electrical information, please refer to electric characteristics on page 116.

<sup>5</sup>Piping lengths are equivalent.

Table 12: LMU187HV Efficiency Ratings.<sup>1,2</sup>

System	Combined With	Rated Cooling Capacity (Btu/h)	EER (95°F)	SEER	Rated Heating Capacity (Btu/h)	COP (47°F)	HSPF	Low Heating Capacity (Btu/h)	COP (17°F)	Energy Star
LMU187HV	Non-ducted Indoor Units	15,600	14.00	21.0	17,000	3.90	9.20	10,000	2.9	Yes
	Ducted Indoor Units	14,800	11.90	17.7	16,800	3.80	8.80	9,900	2.8	No
	Mixed Non-ducted and Ducted Indoor Units	15,200	12.95	19.35	16,900	3.9	9.00	9,950	2.8	No

Table 13: LMU247HV Efficiency Ratings.<sup>1,2</sup>

System	Combined With	Rated Cooling Capacity (Btu/h)	EER (95°F)	SEER	Rated Heating Capacity (Btu/h)	COP (47°F)	HSPF	Low Heating Capacity (Btu/h)	COP (17°F)	Energy Star
LMU247HV	Non-ducted Indoor Units	19,200	13.40	21.7	26,400	3.50	9.40	16,200	2.6	Yes
	Ducted Indoor Units	18,000	11.80	16.4	26,200	3.40	8.50	16,400	2.6	No
	Mixed Non-ducted and Ducted Indoor Units	18,600	12.60	19.05	26,300	3.50	8.95	16,300	2.6	No

Table 14: LMU369HV Efficiency Ratings.<sup>1,2</sup>

System	Combined With	Rated Cooling Capacity (Btu/h)	EER (95°F)	SEER	Rated Heating Capacity (Btu/h)	COP (47°F)	HSPF	Low Heating Capacity (Btu/h)	COP (17°F)	Energy Star
LMU369HV	Non-ducted Indoor Units	34,000	12.50	17.5	41,000	3.40	10.5	26,000	2.4	Yes
	Ducted Indoor Units	34,000	12.00	16.5	41,000	3.20	9.5	27,400	2.6	No
	Mixed Non-ducted and Ducted Indoor Units	34,000	12.25	17.0	41,000	3.30	10.0	26,700	2.5	No

<sup>1</sup>Rated capacity is rated 0 ft. above sea level with 25 ft. of refrigerant line per indoor unit and a 0 ft. level difference between outdoor and indoor units. All capacities are net with a combination ratio between 95 – 105%.

Rated cooling capacity rating obtained with air entering the indoor unit at 80°F dry bulb (DB) and 67°F wet bulb (WB) and outdoor ambient conditions of 95°F dry bulb (DB) and 75°F wet bulb (WB).

Rated heating capacity rating obtained with air entering the indoor unit at 70°F dry bulb (DB) and 60°F wet bulb (WB) and outdoor ambient conditions of 47°F dry bulb (DB) and 43°F wet bulb (WB).

<sup>2</sup>Rated capacity is certified under AHRI Standard 210 / 240. EER, IEER, COP, and HSPF are subject to change. See [www.ahrinet.org](http://www.ahrinet.org) for the latest values.

# MULTI F OUTDOOR UNIT

## Dimensions

MULTI F  
MULTI F MAX

Figure 6: LMU187HV External Dimensions.

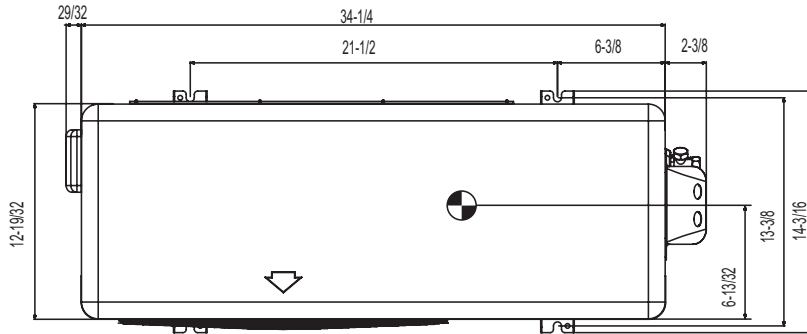

No.	Part Name
1	Air discharge grille
2	Gas pipe connection
3	Liquid pipe connection
4	Power & transmission connection
5	Earth screw

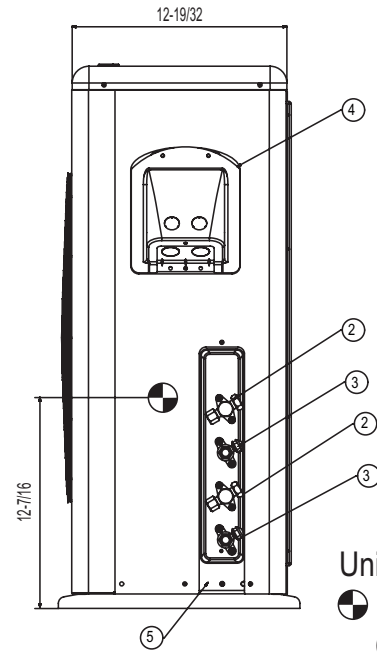
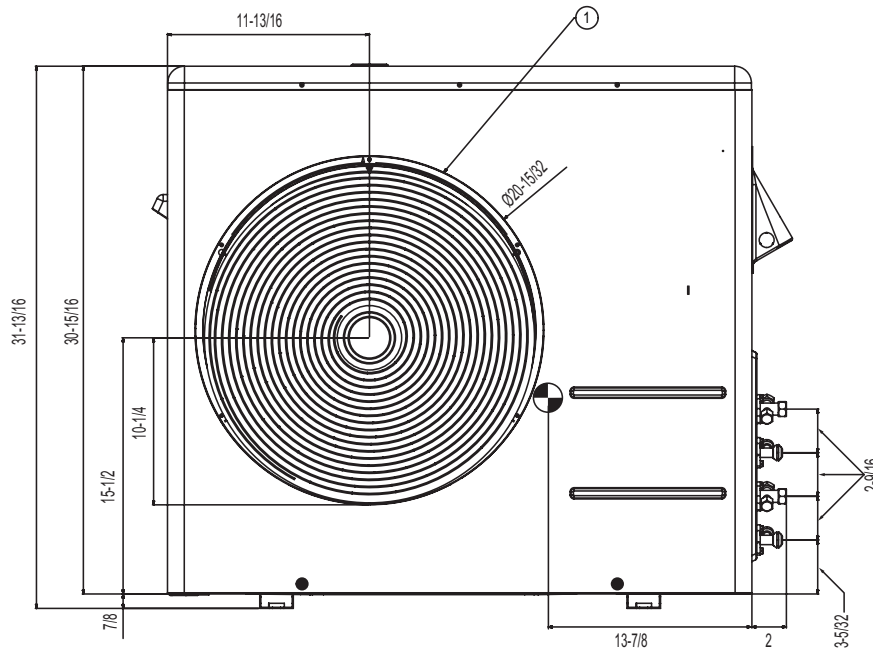

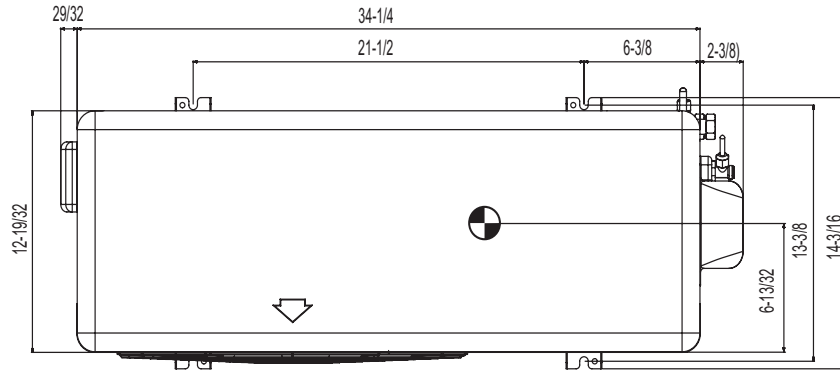

Unit: Inch  
 Center of Gravity

Figure 7: LMU247HV External Dimensions.

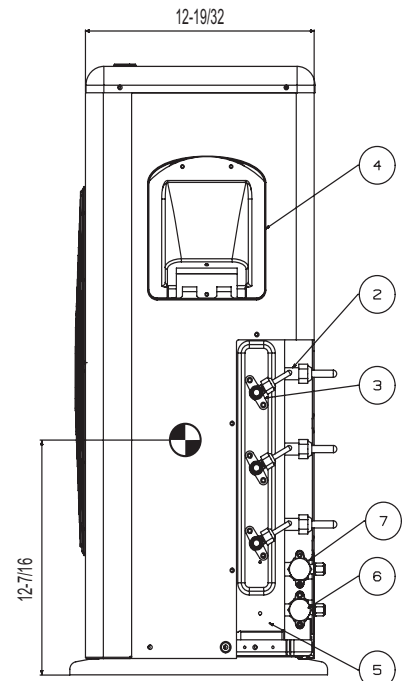
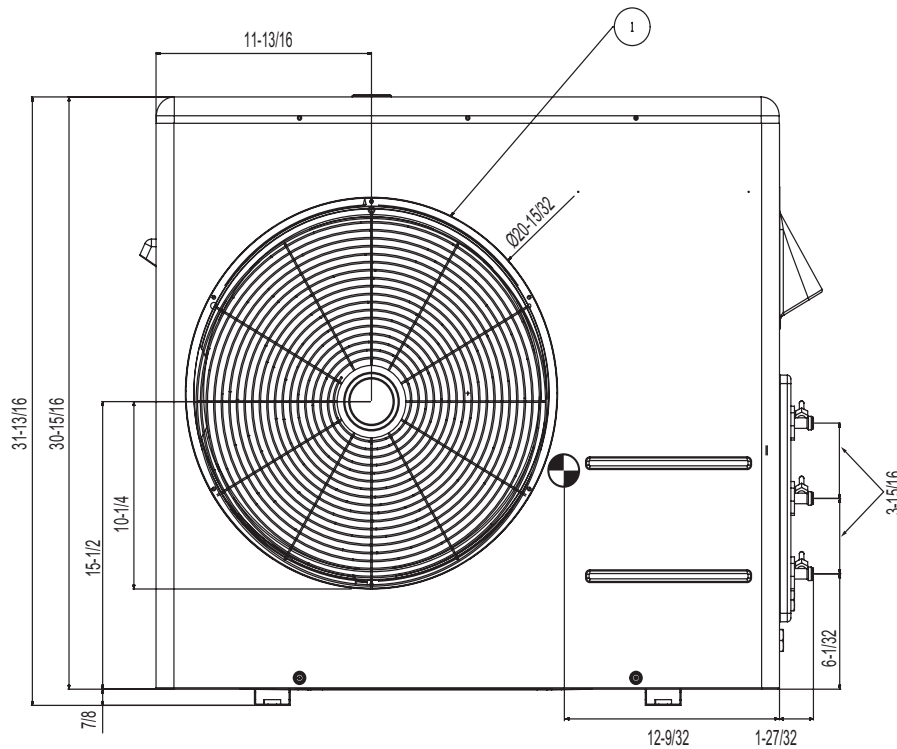

No.	Part Name
1	Air discharge grille
2	Gas pipe connection
3	Liquid pipe connection
4	Power & transmission connection
5	Earth screw
6	Main service valve (Liquid)
7	Main service valve (Gas)



Unit: Inch  
 Center of Gravity

# MULTI F OUTDOOR UNIT

## Dimensions

MULTI F  
MULTI F MAX

Figure 8: LMU369HV External Dimensions.

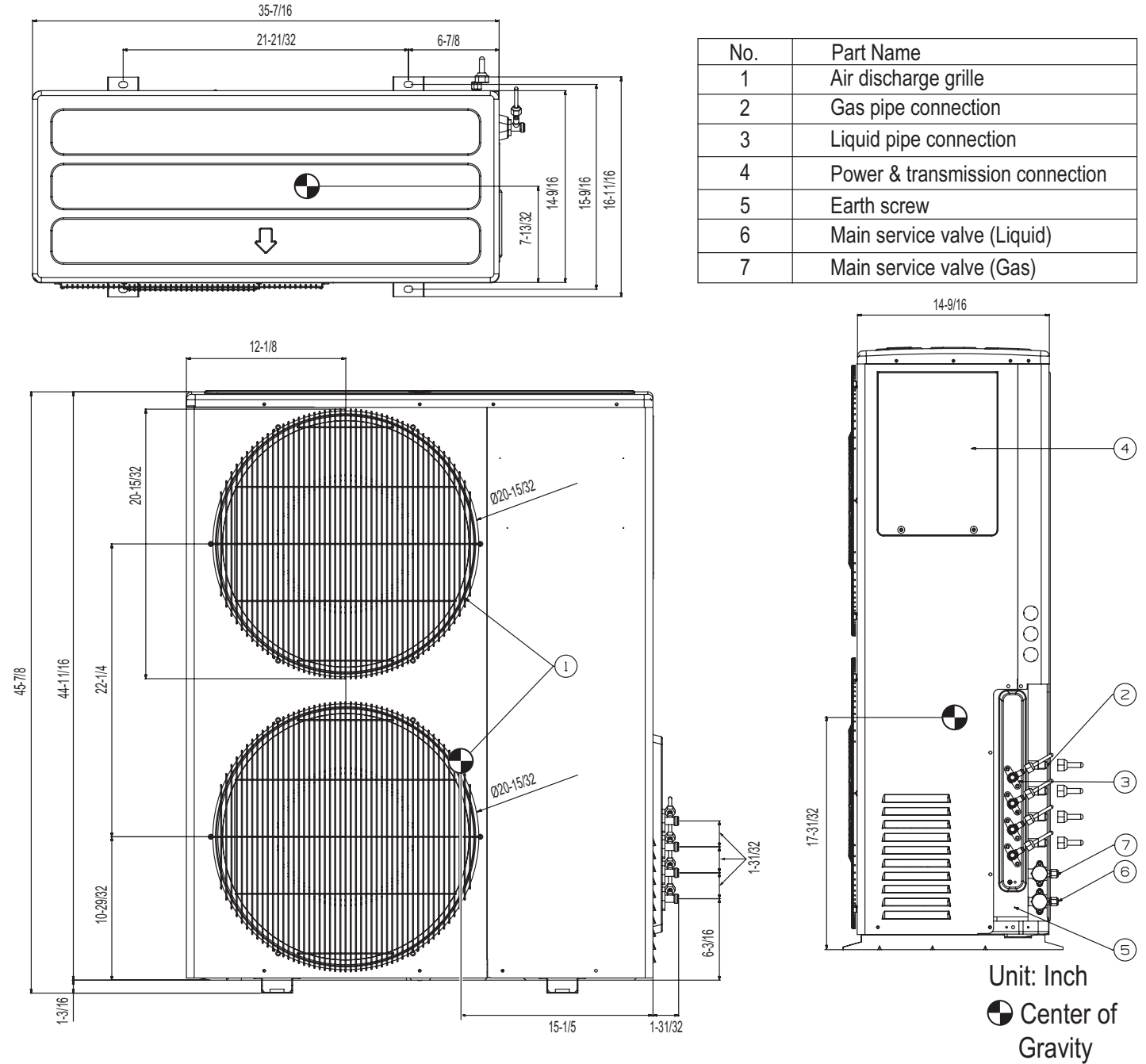

No.	Part Name
1	Air discharge grille
2	Gas pipe connection
3	Liquid pipe connection
4	Power & transmission connection
5	Earth screw
6	Main service valve (Liquid)
7	Main service valve (Gas)

Table 15: LMU187HV with Non-Ducted, Ducted, and Mixed Indoor Units — Rated Cooling Combination Table.

No. of Indoor Units	Indoor Unit Combination (kBtu/h)					Room Capacity				Total Capacity						Input (W)			EER	SEER
	IDU 1	IDU 2	IDU 3	IDU 4	Total	Unit 1 (Btu/h)	Unit 2 (Btu/h)	Unit 3 (Btu/h)	Unit 4 (Btu/h)	Minimum		Rated		Maximum		Min.	Rated	Max.		
										Btu/h	kW	Btu/h	kW	Btu/h	kW					
<b>Non-Ducted Indoor Units</b>																				
Two Units	9	9	-	-	18	7,800	7,800	-	-	10,798	3.16	15,600	4.57	19,000	5.57	924	1,118	2,370	14.0	21.0
	9	12	-	-	21	6,686	8,914	-	-	10,798	3.16	15,600	4.57	19,000	5.57	924	1,118	2,370	14.0	21.0
	12	12	-	-	24	7,800	7,800	-	-	10,798	3.16	15,600	4.57	19,000	5.57	924	1,118	2,370	14.0	21.0
<b>Ducted Indoor Units</b>																				
Two Units	9	9	-	-	18	7,400	7,400	-	-	10,798	3.16	14,800	4.34	19,000	5.57	945	1,244	2,370	11.9	17.7
	9	12	-	-	21	6,343	8,457	-	-	10,798	3.16	14,800	4.34	19,000	5.57	945	1,244	2,370	11.9	17.7
	12	12	-	-	24	7,400	7,400	-	-	10,798	3.16	14,800	4.34	19,000	5.57	945	1,244	2,370	11.9	17.7
<b>Mixed Indoor Units</b>																				
Two Units	9	9	-	-	18	7,600	7,600	-	-	10,798	3.16	15,200	4.46	19,000	5.57	935	1,181	2,370	12.95	19.35
	9	12	-	-	21	6,515	8,685	-	-	10,798	3.16	15,200	4.46	19,000	5.57	935	1,181	2,370	12.95	19.35
	12	12	-	-	24	7,600	7,600	-	-	10,798	3.16	15,200	4.46	19,000	5.57	935	1,181	2,370	12.95	19.35

<sup>1</sup>Capacity as rated: 0 ft. above sea level with 25 ft. of refrigerant piping. <sup>2</sup>Wiring cable size must comply with the applicable local and national codes.  
 0 ft. level difference between outdoor and indoor units. <sup>3</sup>The specification may be subject to change without prior notice for purpose of improvement.  
<sup>4</sup>Cooling capacity rating obtained with air entering the indoor unit at 80°F dry bulb (DB) and 67°F wet bulb (WB), and outdoor ambient conditions of 95°F dry bulb (DB) and 75°F wet bulb (WB). <sup>5</sup>At least two indoor units should be connected.

Table 16: LMU247HV with Non-Ducted, Ducted, and Mixed Indoor Units — Rated Cooling Combination Table.

No. of Indoor Units	Indoor Unit Combination (kBtu/h)					Room Capacity				Total Capacity						Input (W)			EER	SEER
	IDU 1	IDU 2	IDU 3	IDU 4	Total	Unit 1 (Btu/h)	Unit 2 (Btu/h)	Unit 3 (Btu/h)	Unit 4 (Btu/h)	Minimum		Rated		Maximum		Min.	Rated	Max.		
										Btu/h	kW	Btu/h	kW	Btu/h	kW					
<b>Non-Ducted Indoor Units</b>																				
Two Units	9	9	-	-	18	8,500	8,500	-	-	10,798	3.16	17,000	4.98	19,800	5.80	1,002	1,349	2,560	12.6	19.0
	9	12	-	-	21	7,586	10,114	-	-	11,100	3.25	17,700	5.19	23,100	6.77	1,044	1,383	2,830	12.8	19.0
	12	12	-	-	24	9,600	9,600	-	-	11,400	3.34	19,200	5.63	25,500	7.47	1,194	1,469	3,090	13.1	19.0
	9	18	-	-	27	6,400	12,800	-	-	11,400	3.34	19,200	5.63	27,500	8.06	1,284	1,469	3,090	13.1	19.0
	12	18	-	-	30	7,680	11,520	-	-	11,400	3.34	19,200	5.63	27,500	8.06	1,284	1,469	3,090	13.1	19.0
Three Units	9	9	9	-	27	6,400	6,400	6,400	-	11,700	3.43	19,200	5.63	28,800	8.44	1,200	1,431	3,050	13.4	21.7
	9	9	12	-	30	5,760	5,760	7,680	-	11,700	3.43	19,200	5.63	28,800	8.44	1,200	1,431	3,050	13.4	21.7
	9	12	12	-	33	5,236	6,982	6,982	-	11,700	3.43	19,200	5.63	28,800	8.44	1,200	1,431	3,050	13.4	21.7
<b>Ducted Indoor Units</b>																				
Two Units	9	9	-	-	18	8,300	8,300	-	-	10,798	3.16	16,600	4.87	19,800	5.80	1,042	1,495	2,560	11.1	14.4
	9	12	-	-	21	7,286	9,714	-	-	12,000	3.52	17,000	4.98	23,100	6.77	1,084	1,504	2,830	11.3	14.4
	12	12	-	-	24	9,000	9,000	-	-	12,300	3.60	18,000	5.28	25,500	7.47	1,234	1,565	3,090	11.5	14.4
	9	18	-	-	27	6,000	12,000	-	-	12,300	3.60	18,000	5.28	27,500	8.06	1,324	1,565	3,090	11.5	14.4
	12	18	-	-	30	7,200	10,800	-	-	12,300	3.60	18,000	5.28	27,500	8.06	1,324	1,565	3,090	11.5	14.4
Three Units	9	9	9	-	27	6,000	6,000	6,000	-	12,300	3.60	18,000	5.28	28,800	8.44	1,260	1,525	3,050	11.8	16.4
	9	9	12	-	30	5,400	5,400	7,200	-	12,300	3.60	18,000	5.28	28,800	8.44	1,260	1,525	3,050	11.8	16.4
	9	12	12	-	33	4,910	6,545	6,545	-	12,300	3.60	18,000	5.28	28,800	8.44	1,260	1,525	3,050	11.8	16.4
<b>Mixed Indoor Units</b>																				
Two Units	9	9	-	-	18	8,400	8,400	-	-	10,798	3.16	16,800	4.93	19,800	5.80	1,022	1,422	2,560	11.9	16.7
	9	12	-	-	21	7,436	9,914	-	-	11,550	3.39	17,350	5.09	23,100	6.77	1,064	1,444	2,830	12.1	16.7
	12	12	-	-	24	9,300	9,300	-	-	11,850	3.47	18,600	5.46	25,500	7.47	1,214	1,517	3,090	12.3	16.7
	9	18	-	-	27	6,200	12,400	-	-	11,850	3.47	18,600	5.46	27,500	8.06	1,304	1,517	3,090	12.3	16.7
	12	18	-	-	30	7,440	11,160	-	-	11,850	3.47	18,600	5.46	27,500	8.06	1,304	1,517	3,090	12.3	16.7
Three Units	9	9	9	-	27	6,200	6,200	6,200	-	12,000	3.52	18,600	5.46	28,800	8.44	1,230	1,478	3,050	12.6	19.05
	9	9	12	-	30	5,580	5,580	7,440	-	12,000	3.52	18,600	5.46	28,800	8.44	1,230	1,478	3,050	12.6	19.05
	9	12	12	-	33	5,073	6,764	6,764	-	12,000	3.52	18,600	5.46	28,800	8.44	1,230	1,478	3,050	12.6	19.05

<sup>1</sup>Capacity as rated: 0 ft. above sea level with 25 ft. of refrigerant piping. <sup>2</sup>Wiring cable size must comply with the applicable local and national codes.  
 0 ft. level difference between outdoor and indoor units. <sup>3</sup>The specification may be subject to change without prior notice for purpose of improvement.  
<sup>4</sup>Cooling capacity rating obtained with air entering the indoor unit at 80°F dry bulb (DB) and 67°F wet bulb (WB), and outdoor ambient conditions of 95°F dry bulb (DB) and 75°F wet bulb (WB). <sup>5</sup>At least two indoor units should be connected.



# PERFORMANCE DATA

## Rated Cooling Combination Tables

MULTI F  
MULTI F MAX

Table 17: LMU369HV with Non-Ducted and Ducted Indoor Units — Rated Cooling Combination Table.

No. of Indoor Units	Indoor Unit Combination (kBtu/h)					Room Capacity				Total Capacity						Input (W)			EER	SEER
	IDU 1	IDU 2	IDU 3	IDU 4	Total	Unit 1 (Btu/h)	Unit 2 (Btu/h)	Unit 3 (Btu/h)	Unit 4 (Btu/h)	Minimum		Rated		Maximum		Min.	Rated	Max.		
										Btu/h	kW	Btu/h	kW	Btu/h	kW					
<b>Non-Ducted Indoor Units</b>																				
Two Units	9	9	-	-	18	9,000	9,000	-	-	10,798	3.16	18,000	5.28	19,800	5.80	1,140	1,900	2,586	9.5	13.5
	9	12	-	-	21	9,000	12,000	-	-	12,597	3.69	21,000	6.15	23,100	6.77	1,266	2,110	2,872	10.0	14.1
	12	12	-	-	24	12,000	12,000	-	-	14,397	4.22	24,000	7.03	26,400	7.74	1,392	2,320	3,158	10.3	14.7
	9	18	-	-	27	9,000	18,000	-	-	16,197	4.75	27,000	7.91	29,700	8.70	1,452	2,420	3,294	11.2	15.8
	12	18	-	-	30	12,000	18,000	-	-	17,996	5.27	30,000	8.79	33,000	9.67	1,560	2,600	3,539	11.5	16.4
	18	18	-	-	36	16,500	16,500	-	-	19,796	5.80	33,000	9.67	36,300	10.64	1,728	2,880	3,920	11.5	17.1
Three Units	9	9	9	-	27	9,000	9,000	9,000	-	16,197	4.75	27,000	7.91	29,700	8.70	1,452	2,420	3,294	11.2	15.8
	9	9	12	-	30	9,000	9,000	12,000	-	17,996	5.27	30,000	8.79	33,000	9.67	1,560	2,600	3,539	11.5	16.4
	9	12	12	-	33	9,000	12,000	12,000	-	19,796	5.80	33,000	9.67	36,300	10.64	1,644	2,740	3,729	12.0	17.1
	12	12	12	-	36	11,333	11,333	11,333	-	20,396	5.98	34,000	9.96	37,400	10.96	1,632	2,720	3,702	12.5	17.5
	9	9	18	-	36	8,500	8,500	17,000	-	20,396	5.98	34,000	9.96	37,400	10.96	1,632	2,720	3,702	12.5	17.5
	9	12	18	-	39	7,846	10,462	15,692	-	20,396	5.98	34,000	9.96	37,400	10.96	1,632	2,720	3,702	12.5	17.5
	12	12	18	-	42	9,714	9,714	14,571	-	20,396	5.98	34,000	9.96	37,400	10.96	1,632	2,720	3,702	12.5	17.5
	9	18	18	-	45	6,800	13,600	13,600	-	20,396	5.98	34,000	9.96	37,400	10.96	1,632	2,720	3,702	12.5	17.5
	12	18	18	-	48	8,500	12,750	12,750	-	20,396	5.98	34,000	9.96	37,400	10.96	1,632	2,720	3,702	12.5	17.5
Four Units	9	9	9	9	36	8,500	8,500	8,500	8,500	20,396	5.98	34,000	9.96	37,400	10.96	1,632	2,720	3,702	12.5	17.5
	9	9	9	12	39	7,846	7,846	7,846	10,462	20,396	5.98	34,000	9.96	37,400	10.96	1,632	2,720	3,702	12.5	17.5
	9	9	12	12	42	7,286	7,286	9,714	9,714	20,396	5.98	34,000	9.96	37,400	10.96	1,632	2,720	3,702	12.5	17.5
	9	12	12	12	45	6,800	9,067	9,067	9,067	20,396	5.98	34,000	9.96	37,400	10.96	1,632	2,720	3,702	12.5	17.5
	9	9	9	18	45	6,800	6,800	6,800	13,600	20,396	5.98	34,000	9.96	37,400	10.96	1,632	2,720	3,702	12.5	17.5
	9	9	12	18	48	6,375	6,375	8,500	12,750	20,396	5.98	34,000	9.96	37,400	10.96	1,632	2,720	3,702	12.5	17.5
	12	12	12	12	48	8,500	8,500	8,500	8,500	20,396	5.98	34,000	9.96	37,400	10.96	1,632	2,720	3,702	12.5	17.5
<b>Ducted Indoor Units</b>																				
Two Units	9	9	-	-	18	9,000	9,000	-	-	10,798	3.16	18,000	5.28	19,800	5.80	1,188	1,980	2,695	9.1	12.7
	9	12	-	-	21	9,000	12,000	-	-	12,597	3.69	21,000	6.15	23,100	6.77	1,320	2,200	2,995	9.5	13.4
	12	12	-	-	24	12,000	12,000	-	-	14,397	4.22	24,000	7.03	26,400	7.74	1,452	2,420	3,294	9.9	13.9
	9	18	-	-	27	9,000	18,000	-	-	16,197	4.75	27,000	7.91	29,700	8.70	1,518	2,530	3,443	10.7	14.9
	12	18	-	-	30	12,000	18,000	-	-	17,996	5.27	30,000	8.79	33,000	9.67	1,626	2,710	3,688	11.1	15.5
	24	9	-	-	33	24,000	9,000	-	-	19,796	5.80	33,000	9.67	35,200	10.32	1,800	3,000	3,925	11.0	15.4
	18	18	-	-	36	16,500	16,500	-	-	19,796	5.80	33,000	9.67	36,300	10.64	1,800	3,000	4,083	11.0	15.4
	24	12	-	-	36	22,000	11,000	-	-	19,796	5.80	33,000	9.67	36,300	10.64	1,800	3,000	4,083	11.0	15.4
Three Units	9	9	9	-	27	9,000	9,000	9,000	-	16,197	4.75	27,000	7.91	29,700	8.70	1,518	2,530	3,443	10.7	14.9
	9	9	12	-	30	9,000	9,000	12,000	-	17,996	5.27	30,000	8.79	33,000	9.67	1,626	2,710	3,688	11.1	15.5
	9	12	12	-	33	9,000	12,000	12,000	-	19,796	5.80	33,000	9.67	36,300	10.64	1,716	2,860	3,892	11.5	16.2
	12	12	12	-	36	11,333	11,333	11,333	-	20,396	5.98	34,000	9.96	37,400	10.96	1,704	2,840	3,865	12.0	16.5
	9	9	18	-	36	8,500	8,500	17,000	-	20,396	5.98	34,000	9.96	37,400	10.96	1,704	2,840	3,865	12.0	16.5
	9	12	18	-	39	7,846	10,462	15,692	-	20,396	5.98	34,000	9.96	37,400	10.96	1,704	2,840	3,865	12.0	16.5
	12	12	18	-	42	9,714	9,714	14,571	-	20,396	5.98	34,000	9.96	37,400	10.96	1,704	2,840	3,865	12.0	16.5
	9	18	18	-	45	6,800	13,600	13,600	-	20,396	5.98	34,000	9.96	37,400	10.96	1,704	2,840	3,865	12.0	16.5
	12	18	18	-	48	8,500	12,750	12,750	-	20,396	5.98	34,000	9.96	37,400	10.96	1,704	2,840	3,865	12.0	16.5
Four Units	9	9	9	9	36	8,500	8,500	8,500	8,500	20,396	5.98	34,000	9.96	37,400	10.96	1,704	2,840	3,865	12.0	16.5
	9	9	9	12	39	7,846	7,846	7,846	10,462	20,396	5.98	34,000	9.96	37,400	10.96	1,704	2,840	3,865	12.0	16.5
	9	9	12	12	42	7,286	7,286	9,714	9,714	20,396	5.98	34,000	9.96	37,400	10.96	1,704	2,840	3,865	12.0	16.5
	9	12	12	12	45	6,800	9,067	9,067	9,067	20,396	5.98	34,000	9.96	37,400	10.96	1,704	2,840	3,865	12.0	16.5
	9	9	9	18	45	6,800	6,800	6,800	13,600	20,396	5.98	34,000	9.96	37,400	10.96	1,704	2,840	3,865	12.0	16.5
	9	9	12	18	48	6,375	6,375	8,500	12,750	20,396	5.98	34,000	9.96	37,400	10.96	1,704	2,840	3,865	12.0	16.5
	12	12	12	12	48	8,500	8,500	8,500	8,500	20,396	5.98	34,000	9.96	37,400	10.96	1,704	2,840	3,865	12.0	16.5

<sup>1</sup>Capacity as rated: 0 ft. above sea level with 25 ft. of refrigerant piping.  
0 ft. level difference between outdoor and indoor units.

<sup>2</sup>Cooling capacity rating obtained with air entering the indoor unit at 80°F dry bulb (DB) and 67°F wet bulb (WB), and outdoor ambient conditions of 95°F dry bulb (DB) and 75°F wet bulb (WB).

<sup>3</sup>Wiring cable size must comply with the applicable local and national codes.

<sup>4</sup>The specification may be subject to change without prior notice for purpose of improvement.

<sup>5</sup>At least two indoor units should be connected.



Multi F and Multi F MAX Heat Pump System Engineering Manual

Table 18: LMU369HV with Mixed Indoor Units — Rated Cooling Combination Table.

No. of Indoor Units	Indoor Unit Combination (kBtu/h)					Room Capacity				Total Capacity						Input (W)			EER	SEER
	IDU 1	IDU 2	IDU 3	IDU 4	Total	Unit 1 (Btu/h)	Unit 2 (Btu/h)	Unit 3 (Btu/h)	Unit 4 (Btu/h)	Minimum		Rated		Maximum		Min.	Rated	Max.		
										Btu/h	kW	Btu/h	kW	Btu/h	kW					
<i>Mixed Indoor Units</i>																				
Two Units	9	9	-	-	18	9,000	9,000	-	-	10,798	3.16	18,000	5.28	19,800	5.80	1,164	1,940	2,641	9.3	13.1
	9	12	-	-	21	9,000	12,000	-	-	12,597	3.69	21,000	6.15	23,100	6.77	1,293	2,155	2,934	9.7	13.8
	12	12	-	-	24	12,000	12,000	-	-	14,397	4.22	24,000	7.03	26,400	7.74	1,422	2,370	3,226	10.1	14.3
	9	18	-	-	27	9,000	18,000	-	-	16,197	4.75	27,000	7.91	29,700	8.70	1,485	2,475	3,369	10.9	15.4
	12	18	-	-	30	12,000	18,000	-	-	17,996	5.27	30,000	8.79	33,000	9.67	1,593	2,655	3,614	11.3	16.0
	24	9	-	-	33	24,000	9,000	-	-	19,796	5.80	33,000	9.67	35,200	10.32	1,764	2,940	3,876	11.2	15.8
	18	18	-	-	36	16,500	16,500	-	-	19,796	5.80	33,000	9.67	36,300	10.64	1,764	2,940	4,002	11.2	15.8
24	12	-	-	36	22,000	11,000	-	-	19,796	5.80	33,000	9.67	36,300	10.64	1,764	2,940	4,002	11.2	15.8	
Three Units	9	9	9	-	27	9,000	9,000	9,000	-	16,197	4.75	27,000	7.91	29,700	8.70	1,485	2,475	3,369	10.9	15.4
	9	9	12	-	30	9,000	9,000	12,000	-	17,996	5.27	30,000	8.79	33,000	9.67	1,593	2,655	3,614	11.3	16.0
	9	12	12	-	33	9,000	12,000	12,000	-	19,796	5.80	33,000	9.67	36,300	10.64	1,680	2,800	3,811	11.8	16.7
	12	12	12	-	36	11,333	11,333	11,333	-	20,396	5.98	34,000	9.96	37,400	10.96	1,668	2,780	3,784	12.25	17.0
	9	9	18	-	36	8,500	8,500	17,000	-	20,396	5.98	34,000	9.96	37,400	10.96	1,668	2,780	3,784	12.25	17.0
	9	12	18	-	39	7,846	10,462	15,692	-	20,396	5.98	34,000	9.96	37,400	10.96	1,668	2,780	3,784	12.25	17.0
	12	12	18	-	42	9,714	9,714	14,571	-	20,396	5.98	34,000	9.96	37,400	10.96	1,668	2,780	3,784	12.25	17.0
	9	18	18	-	45	6,800	13,600	13,600	-	20,396	5.98	34,000	9.96	37,400	10.96	1,668	2,780	3,784	12.25	17.0
12	18	18	-	48	8,500	12,750	12,750	-	20,396	5.98	34,000	9.96	37,400	10.96	1,668	2,780	3,784	12.25	17.0	
Four Units	9	9	9	9	36	8,500	8,500	8,500	8,500	20,396	5.98	34,000	9.96	37,400	10.96	1,668	2,780	3,784	12.25	17.0
	9	9	9	12	39	7,846	7,846	7,846	10,462	20,396	5.98	34,000	9.96	37,400	10.96	1,668	2,780	3,784	12.25	17.0
	9	9	12	12	42	7,286	7,286	9,714	9,714	20,396	5.98	34,000	9.96	37,400	10.96	1,668	2,780	3,784	12.25	17.0
	9	12	12	12	45	6,800	9,067	9,067	9,067	20,396	5.98	34,000	9.96	37,400	10.96	1,668	2,780	3,784	12.25	17.0
	9	9	9	18	45	6,800	6,800	6,800	13,600	20,396	5.98	34,000	9.96	37,400	10.96	1,668	2,780	3,784	12.25	17.0
	9	9	12	18	48	6,375	6,375	8,500	12,750	20,396	5.98	34,000	9.96	37,400	10.96	1,668	2,780	3,784	12.25	17.0
	12	12	12	12	48	8,500	8,500	8,500	8,500	20,396	5.98	34,000	9.96	37,400	10.96	1,668	2,780	3,784	12.25	17.0

<sup>1</sup>Capacity as rated: 0 ft. above sea level with 25 ft. of refrigerant piping.  
0 ft. level difference between outdoor and indoor units.

<sup>2</sup>Cooling capacity rating obtained with air entering the indoor unit at 80°F dry bulb (DB) and 67°F wet bulb (WB), and outdoor ambient conditions of 95°F dry bulb (DB) and 75°F wet bulb (WB).

<sup>3</sup>Wiring cable size must comply with the applicable local and national codes.

<sup>4</sup>The specification may be subject to change without prior notice for purpose of improvement.

<sup>5</sup>At least two indoor units should be connected.

# PERFORMANCE DATA

## Rated Heating Combination Tables

**MULTI F**  
**MULTI F MAX**

Table 19: LMU187HV with Non-Ducted, Ducted, and Mixed Indoor Units — Rated Heating Combination Table.

No. of Indoor Units	Indoor Unit Combination (kBtu/h)					Room Capacity				Total Capacity						Input (W)			EER	SEER
	IDU 1	IDU 2	IDU 3	IDU 4	Total	Unit 1 (Btu/h)	Unit 2 (Btu/h)	Unit 3 (Btu/h)	Unit 4 (Btu/h)	Minimum		Rated		Maximum		Min.	Rated	Max.		
										Btu/h	kW	Btu/h	kW	Btu/h	kW					
<b>Non-Ducted Indoor Units</b>																				
Two Units	9	9	-	-	18	8,500	8,500	-	-	12,418	3.64	17,000	4.98	21,000	6.15	1,150	1,290	2,480	3.9	9.2
	9	12	-	-	21	7,286	9,714	-	-	12,418	3.64	17,000	4.98	21,000	6.15	1,150	1,290	2,480	3.9	9.2
	12	12	-	-	24	8,500	8,500	-	-	12,418	3.64	17,000	4.98	21,000	6.15	1,150	1,290	2,480	3.9	9.2
<b>Ducted Indoor Units</b>																				
Two Units	9	9	-	-	18	8,400	8,400	-	-	12,418	3.64	16,800	4.92	21,000	6.15	1,170	1,306	2,480	3.8	8.8
	9	12	-	-	21	7,200	9,600	-	-	12,418	3.64	16,800	4.92	21,000	6.15	1,170	1,306	2,480	3.8	8.8
	12	12	-	-	24	8,400	8,400	-	-	12,418	3.64	16,800	4.92	21,000	6.15	1,170	1,306	2,480	3.8	8.8
<b>Mixed Indoor Units</b>																				
Two Units	9	9	-	-	18	8,450	8,450	-	-	12,418	3.64	16,900	4.95	21,000	6.15	1,160	1,298	2,480	3.9	9.0
	12	12	-	-	21	7,243	9,657	-	-	12,418	3.64	16,900	4.95	21,000	6.15	1,160	1,298	2,480	3.9	9.0
	12	12	-	-	24	8,450	8,450	-	-	12,418	3.64	16,900	4.95	21,000	6.15	1,160	1,298	2,480	3.9	9.0

<sup>1</sup>Capacity as rated: 0 ft. above sea level with 25 ft. of refrigerant piping.  
0 ft. level difference between outdoor and indoor units.

<sup>3</sup>Wiring cable size must comply with the applicable local and national codes.

<sup>2</sup>Heating capacity rating obtained with air entering the indoor unit at 70°F dry bulb (DB) and 60°F wet bulb (WB), and outdoor ambient conditions of 47°F dry bulb (DB) and 43°F wet bulb (WB).

<sup>4</sup>The specification may be subject to change without prior notice for purpose of improvement.

<sup>5</sup>At least two indoor units should be connected.

Table 20: LMU247HV with Non-Ducted, Ducted, and Mixed Indoor Units — Rated Heating Combination Table.

No. of Indoor Units	Indoor Unit Combination (kBtu/h)					Room Capacity				Total Capacity						Input (W)			EER	SEER
	IDU 1	IDU 2	IDU 3	IDU 4	Total	Unit 1 (Btu/h)	Unit 2 (Btu/h)	Unit 3 (Btu/h)	Unit 4 (Btu/h)	Minimum		Rated		Maximum		Min.	Rated	Max.		
										Btu/h	kW	Btu/h	kW	Btu/h	kW					
<b>Non-Ducted Indoor Units</b>																				
Two Units	9	9	-	-	18	10,120	10,120	-	-	12,418	3.64	20,240	5.93	23,700	6.95	1,200	1,951	2,660	3.0	7.7
	9	12	-	-	21	9,857	13,143	-	-	12,765	3.74	23,000	6.74	27,700	8.12	1,260	2,174	3,010	3.1	7.7
	12	12	-	-	24	13,200	13,200	-	-	16,200	4.75	26,400	7.74	29,040	8.51	1,368	2,320	3,100	3.3	8.2
	9	18	-	-	27	8,800	17,600	-	-	16,200	4.75	26,400	7.74	31,500	9.23	1,428	2,320	3,100	3.3	8.2
	12	18	-	-	30	10,560	15,840	-	-	16,200	4.75	26,400	7.74	31,500	9.23	1,428	2,320	3,100	3.3	8.2
Three Units	9	9	9	-	27	8,800	8,800	8,800	-	16,200	4.75	26,400	7.74	32,000	9.38	1,308	2,207	3,090	3.5	9.4
	9	9	12	-	30	7,920	7,920	10,560	-	16,200	4.75	26,400	7.74	32,000	9.38	1,308	2,207	3,090	3.5	9.4
	9	12	12	-	33	7,200	9,600	9,600	-	16,200	4.75	26,400	7.74	32,000	9.38	1,308	2,207	3,090	3.5	9.4
<b>Ducted Indoor Units</b>																				
Two Units	9	9	-	-	18	10,000	10,000	-	-	12,418	3.64	20,000	5.86	23,700	6.95	1,240	1,967	2,660	3.0	7.9
	9	12	-	-	21	9,771	13,029	-	-	13,800	4.04	22,800	6.68	27,700	8.12	1,300	2,227	3,010	3.0	7.9
	12	12	-	-	24	13,100	13,100	-	-	16,500	4.84	26,200	7.68	29,040	8.51	1,408	2,360	3,100	3.3	8.1
	9	18	-	-	27	8,733	17,467	-	-	16,500	4.84	26,200	7.68	31,500	9.23	1,468	2,360	3,100	3.3	8.1
	12	18	-	-	30	10,480	15,720	-	-	16,500	4.84	26,200	7.68	31,500	9.23	1,468	2,360	3,100	3.3	8.1
Three Units	9	9	9	-	27	8,733	8,733	8,733	-	16,500	4.84	26,200	7.68	32,000	9.38	1,368	2,226	3,090	3.4	8.5
	9	9	12	-	30	7,860	7,860	10,480	-	16,500	4.84	26,200	7.68	32,000	9.38	1,368	2,226	3,090	3.4	8.5
	9	12	12	-	33	7,145	9,527	9,527	-	16,500	4.84	26,200	7.68	32,000	9.38	1,368	2,226	3,090	3.4	8.5
<b>Mixed Indoor Units</b>																				
Two Units	9	9	-	-	18	10,060	10,060	-	-	12,418	3.64	20,120	5.90	23,700	6.95	1,220	1,959	2,660	3.0	7.8
	9	12	-	-	21	9,814	13,086	-	-	13,283	3.89	22,900	6.71	27,700	8.12	1,280	2,201	3,010	3.1	7.8
	12	12	-	-	24	13,150	13,150	-	-	16,350	4.80	26,300	7.71	29,040	8.51	1,388	2,340	3,100	3.3	8.2
	9	18	-	-	27	8,767	17,534	-	-	16,350	4.80	26,300	7.71	31,500	9.23	1,448	2,340	3,100	3.3	8.2
	12	18	-	-	30	10,520	15,780	-	-	16,350	4.80	26,300	7.71	31,500	9.23	1,448	2,340	3,100	3.3	8.2
Three Units	9	9	9	-	27	8,767	8,767	8,767	-	16,350	4.80	26,300	7.71	32,000	9.38	1,338	2,217	3,090	3.5	8.95
	9	9	12	-	30	7,890	7,890	10,520	-	16,350	4.80	26,300	7.71	32,000	9.38	1,338	2,217	3,090	3.5	8.95
	9	12	12	-	33	7,173	9,564	9,564	-	16,350	4.80	26,300	7.71	32,000	9.38	1,338	2,217	3,090	3.5	8.95

<sup>1</sup>Capacity as rated: 0 ft. above sea level with 25 ft. of refrigerant piping.  
0 ft. level difference between outdoor and indoor units.

<sup>3</sup>Wiring cable size must comply with the applicable local and national codes.

<sup>2</sup>Heating capacity rating obtained with air entering the indoor unit at 70°F dry bulb (DB) and 60°F wet bulb (WB), and outdoor ambient conditions of 47°F dry bulb (DB) and 43°F wet bulb (WB).

<sup>4</sup>The specification may be subject to change without prior notice for purpose of improvement.

<sup>5</sup>At least two indoor units should be connected.



Multi F and Multi F MAX Heat Pump System Engineering Manual

Table 21: LMU369HV with Non-Ducted and Ducted Indoor Units — Rated Heating Combination Table.

No. of Indoor Units	Indoor Unit Combination (kBtu/h)					Room Capacity				Total Capacity						Input (W)			EER	SEER
	IDU 1	IDU 2	IDU 3	IDU 4	Total	Unit 1 (Btu/h)	Unit 2 (Btu/h)	Unit 3 (Btu/h)	Unit 4 (Btu/h)	Minimum		Rated		Maximum		Min.	Rated	Max.		
										Btu/h	kW	Btu/h	kW	Btu/h	kW					
<i>Non-Ducted Indoor Units</i>																				
Two Units	9	9	-	-	18	10,350	10,350	-	-	12,418	3.64	20,700	6.07	22,770	6.67	1,248	2,080	2,416	2.9	9.3
	9	12	-	-	21	10,350	13,800	-	-	14,487	4.25	24,150	7.08	26,510	7.77	1,524	2,540	2,950	2.8	8.9
	12	12	-	-	24	13,800	13,800	-	-	16,557	4.85	27,600	8.09	30,360	8.90	1,554	2,590	3,008	3.1	10.0
	9	18	-	-	27	10,350	20,700	-	-	18,626	5.46	31,050	9.10	33,000	9.67	1,740	2,900	3,368	3.1	10.0
	12	18	-	-	30	13,800	20,700	-	-	20,696	6.07	34,500	10.11	36,300	10.64	1,932	3,220	3,740	3.1	10.0
	18	18	-	-	36	19,000	19,000	-	-	22,795	6.68	38,000	11.14	40,000	11.72	2,118	3,530	4,100	3.2	10.1
Three Units	9	9	9	-	27	10,350	10,350	10,350	-	18,626	5.46	31,050	9.10	34,100	9.99	1,740	2,900	3,368	3.1	10.0
	9	9	12	-	30	10,350	10,350	13,800	-	20,696	6.07	34,500	10.11	37,400	10.96	1,932	3,220	3,740	3.1	10.0
	9	12	12	-	33	10,350	13,800	13,800	-	22,765	6.67	37,950	11.12	38,500	11.28	2,040	3,400	3,949	3.3	10.4
	12	12	12	-	36	13,667	13,667	13,667	-	24,595	7.21	41,000	12.02	45,100	13.22	2,148	3,580	4,153	3.4	10.5
	9	9	18	-	36	10,250	10,250	20,500	-	24,595	7.21	41,000	12.02	45,100	13.22	2,148	3,580	4,153	3.4	10.5
	9	12	18	-	39	9,462	12,615	18,923	-	24,595	7.21	41,000	12.02	45,100	13.22	2,148	3,580	4,153	3.4	10.5
	12	12	18	-	42	11,714	11,714	17,571	-	24,595	7.21	41,000	12.02	45,100	13.22	2,148	3,580	4,153	3.4	10.5
	9	18	18	-	45	8,200	16,400	16,400	-	24,595	7.21	41,000	12.02	45,100	13.22	2,148	3,580	4,153	3.4	10.5
	12	18	18	-	48	10,250	15,375	15,375	-	24,595	7.21	41,000	12.02	45,100	13.22	2,148	3,580	4,153	3.4	10.5
Four Units	9	9	9	9	36	10,250	10,250	10,250	10,250	24,595	7.21	41,000	12.02	45,100	13.22	2,148	3,580	4,153	3.4	10.5
	9	9	9	12	39	9,462	9,462	9,462	12,615	24,595	7.21	41,000	12.02	45,100	13.22	2,148	3,580	4,153	3.4	10.5
	9	9	12	12	42	8,786	8,786	11,714	11,714	24,595	7.21	41,000	12.02	45,100	13.22	2,148	3,580	4,153	3.4	10.5
	9	12	12	12	45	8,200	10,933	10,933	10,933	24,595	7.21	41,000	12.02	45,100	13.22	2,148	3,580	4,153	3.4	10.5
	9	9	9	18	45	8,200	8,200	8,200	16,400	24,595	7.21	41,000	12.02	45,100	13.22	2,148	3,580	4,153	3.4	10.5
	9	9	12	18	48	7,688	7,688	10,250	15,374	24,595	7.21	41,000	12.02	45,100	13.22	2,148	3,580	4,153	3.4	10.5
	12	12	12	12	48	10,250	10,250	10,250	10,250	24,595	7.21	41,000	12.02	45,100	13.22	2,148	3,580	4,153	3.4	10.5
<i>Ducted Indoor Units</i>																				
Two Units	9	9	-	-	18	10,350	10,350	-	-	12,418	3.64	20,700	6.07	22,770	6.67	1,302	2,170	2,520	2.8	8.5
	9	12	-	-	21	10,350	13,800	-	-	14,487	4.25	24,150	7.08	26,510	7.77	1,536	2,560	2,973	2.8	8.8
	12	12	-	-	24	13,800	13,800	-	-	16,557	4.85	27,600	8.09	30,360	8.90	1,614	2,690	3,124	3.0	9.0
	9	18	-	-	27	10,350	20,700	-	-	18,626	5.46	31,050	9.10	33,000	9.67	1,812	3,020	3,508	3.0	9.0
	12	18	-	-	30	13,800	20,700	-	-	20,696	6.07	34,500	10.11	36,300	10.64	2,010	3,350	3,891	3.0	9.0
	24	9	-	-	33	27,636	10,364	-	-	21,595	6.33	36,000	10.55	38,500	11.28	2,095	3,490	4,124	3.0	9.0
	18	18	-	-	36	19,000	19,000	-	-	22,795	6.68	38,000	11.14	40,000	11.72	2,208	3,680	4,274	3.0	9.0
	24	12	-	-	36	25,333	12,667	-	-	22,795	6.68	38,000	11.14	40,000	11.72	2,208	3,680	4,274	3.0	9.0
Three Units	9	9	9	-	27	10,350	10,350	10,350	-	18,626	5.46	31,050	9.10	34,100	9.99	1,812	3,020	3,508	3.0	9.0
	9	9	12	-	30	10,350	10,350	13,800	-	20,696	6.07	34,500	10.11	37,400	10.96	2,010	3,350	3,891	3.0	9.0
	9	12	12	-	33	10,350	13,800	13,800	-	22,765	6.67	37,950	11.12	38,500	11.28	2,130	3,550	4,123	3.1	9.2
	12	12	12	-	36	13,667	13,667	13,667	-	24,595	7.21	41,000	12.02	45,100	13.22	2,232	3,720	4,321	3.2	9.5
	9	9	18	-	36	10,250	10,250	20,500	-	24,595	7.21	41,000	12.02	45,100	13.22	2,232	3,720	4,321	3.2	9.5
	9	12	18	-	39	9,462	12,615	18,923	-	24,595	7.21	41,000	12.02	45,100	13.22	2,232	3,720	4,321	3.2	9.5
	12	12	18	-	42	11,714	11,714	17,571	-	24,595	7.21	41,000	12.02	45,100	13.22	2,232	3,720	4,321	3.2	9.5
	9	18	18	-	45	8,200	16,400	16,400	-	24,595	7.21	41,000	12.02	45,100	13.22	2,232	3,720	4,321	3.2	9.5
	12	18	18	-	48	10,250	15,375	15,375	-	24,595	7.21	41,000	12.02	45,100	13.22	2,232	3,720	4,321	3.2	9.5
Four Units	9	9	9	9	36	10,250	10,250	10,250	10,250	24,595	7.21	41,000	12.02	45,100	13.22	2,232	3,720	4,321	3.2	9.5
	9	9	9	12	39	9,462	9,462	9,462	12,615	24,595	7.21	41,000	12.02	45,100	13.22	2,232	3,720	4,321	3.2	9.5
	9	9	12	12	42	8,786	8,786	11,714	11,714	24,595	7.21	41,000	12.02	45,100	13.22	2,232	3,720	4,321	3.2	9.5
	9	12	12	12	45	8,200	10,933	10,933	10,933	24,595	7.21	41,000	12.02	45,100	13.22	2,232	3,720	4,321	3.2	9.5
	9	9	9	18	45	8,200	8,200	8,200	16,400	24,595	7.21	41,000	12.02	45,100	13.22	2,232	3,720	4,321	3.2	9.5
	9	9	12	18	48	7,688	7,688	10,250	15,374	24,595	7.21	41,000	12.02	45,100	13.22	2,232	3,720	4,321	3.2	9.5
	12	12	12	12	48	10,250	10,250	10,250	10,250	24,595	7.21	41,000	12.02	45,100	13.22	2,232	3,720	4,321	3.2	9.5

\*Capacity as rated:

0 ft. above sea level with 25 ft. of refrigerant piping.  
0 ft. level difference between outdoor and indoor units.

<sup>4</sup>The specification may be subject to change without prior notice for purpose of improvement.

<sup>5</sup>At least two indoor units should be connected.

<sup>2</sup>Heating capacity rating obtained with air entering the indoor unit at 70°F dry bulb (DB) and 60°F wet bulb (WB), and outdoor ambient conditions of 47°F dry bulb (DB) and 43°F wet bulb (WB).

<sup>3</sup>Wiring cable size must comply with the applicable local and national codes.



# PERFORMANCE DATA

## Rated Heating Combination Tables

MULTI F  
MULTI F MAX

Table 22: LMU369HV with Mixed Indoor Units — Rated Heating Combination Table.

No. of Indoor Units	Indoor Unit Combination (kBtu/h)					Room Capacity				Total Capacity						Input (W)			EER	SEER
	IDU 1	IDU 2	IDU 3	IDU 4	Total	Unit 1 (Btu/h)	Unit 2 (Btu/h)	Unit 3 (Btu/h)	Unit 4 (Btu/h)	Minimum		Rated		Maximum		Min.	Rated	Max.		
										Btu/h	kW	Btu/h	kW	Btu/h	kW					
<i>Mixed Indoor Units</i>																				
Two Units	9	9	-	-	18	10,350	10,350	-	-	12,418	3.64	20,700	6.07	22,770	6.67	1,275	2,125	2,468	2.9	8.9
	9	12	-	-	21	10,350	13,800	-	-	14,487	4.25	24,150	7.08	26,510	7.77	1,530	2,550	2,962	2.8	8.9
	12	12	-	-	24	13,800	13,800	-	-	16,557	4.85	27,600	8.09	30,360	8.90	1,584	2,640	3,066	3.1	9.5
	9	18	-	-	27	10,350	20,700	-	-	18,626	5.46	31,050	9.10	33,000	9.67	1,776	2,960	3,438	3.1	9.5
	12	18	-	-	30	13,800	20,700	-	-	20,696	6.07	34,500	10.11	36,300	10.64	1,971	3,285	3,816	3.1	9.5
	24	9	-	-	33	27,636	10,364	-	-	21,595	6.33	36,000	10.55	38,500	11.28	2,054	3,425	4,045	3.1	9.5
	18	18	-	-	36	19,000	19,000	-	-	22,795	6.68	38,000	11.14	40,000	11.72	2,163	3,605	4,187	3.1	9.6
	24	12	-	-	36	25,333	12,667	-	-	22,795	6.68	38,000	11.14	40,000	11.72	2,163	3,605	4,187	3.1	9.6
Three Units	9	9	9	-	27	10,350	10,350	10,350	-	18,626	5.46	31,050	9.10	34,100	9.99	1,776	2,960	3,438	3.1	9.5
	9	9	12	-	30	10,350	10,350	13,800	-	20,696	6.07	34,500	10.11	37,400	10.96	1,971	3,285	3,816	3.1	9.5
	9	12	12	-	33	10,350	13,800	13,800	-	22,765	6.67	37,950	11.12	38,500	11.28	2,085	3,475	4,036	3.2	9.8
	12	12	12	-	36	13,667	13,667	13,667	-	24,595	7.21	41,000	12.02	45,100	13.22	2,190	3,650	4,237	3.3	10.0
	9	9	18	-	36	10,250	10,250	20,500	-	24,595	7.21	41,000	12.02	45,100	13.22	2,190	3,650	4,237	3.3	10.0
	9	12	18	-	39	9,462	12,615	18,923	-	24,595	7.21	41,000	12.02	45,100	13.22	2,190	3,650	4,237	3.3	10.0
	12	12	18	-	42	11,714	11,714	17,571	-	24,595	7.21	41,000	12.02	45,100	13.22	2,190	3,650	4,237	3.3	10.0
	9	18	18	-	45	8,200	16,400	16,400	-	24,595	7.21	41,000	12.02	45,100	13.22	2,190	3,650	4,237	3.3	10.0
	12	18	18	-	48	10,250	15,375	15,375	-	24,595	7.21	41,000	12.02	45,100	13.22	2,190	3,650	4,237	3.3	10.0
Four Units	9	9	9	9	36	10,250	10,250	10,250	10,250	24,595	7.21	41,000	12.02	45,100	13.22	2,190	3,650	4,237	3.3	10.0
	9	9	9	12	39	9,462	9,462	9,462	12,615	24,595	7.21	41,000	12.02	45,100	13.22	2,190	3,650	4,237	3.3	10.0
	9	9	12	12	42	8,786	8,786	11,714	11,714	24,595	7.21	41,000	12.02	45,100	13.22	2,190	3,650	4,237	3.3	10.0
	9	12	12	12	45	8,200	10,933	10,933	10,933	24,595	7.21	41,000	12.02	45,100	13.22	2,190	3,650	4,237	3.3	10.0
	9	9	9	18	45	8,200	8,200	8,200	16,400	24,595	7.21	41,000	12.02	45,100	13.22	2,190	3,650	4,237	3.3	10.0
	9	9	12	18	48	7,688	7,688	10,250	15,374	24,595	7.21	41,000	12.02	45,100	13.22	2,190	3,650	4,237	3.3	10.0
	12	12	12	12	48	10,250	10,250	10,250	10,250	24,595	7.21	41,000	12.02	45,100	13.22	2,190	3,650	4,237	3.3	10.0

<sup>1</sup>Capacity as rated: 0 ft. above sea level with 25 ft. of refrigerant piping.  
0 ft. level difference between outdoor and indoor units.

<sup>2</sup>Heating capacity rating obtained with air entering the indoor unit at 70°F dry bulb (DB) and 60°F wet bulb (WB), and outdoor ambient conditions of 47°F dry bulb (DB) and 43°F wet bulb (WB).

<sup>3</sup>Wiring cable size must comply with the applicable local and national codes.

<sup>4</sup>The specification may be subject to change without prior notice for purpose of improvement.

<sup>5</sup>At least two indoor units should be connected.



Multi F and Multi F MAX Heat Pump System Engineering Manual

Table 23: LMU187HV Cooling Capacity Table —Non-Ducted Indoor Units.

Connected Indoor Units	Combination Capacity Index	Outdoor Air Temp. (°F DB)	Indoor Air Temp. °F DB / °F WB											
			68 / 57		73 / 61		77 / 64		80 / 67		86 / 72		90 / 75	
			TC	PI	TC	PI	TC	PI	TC	PI	TC	PI	TC	PI
Two (2) Non-Ducted Indoor Units	9 + 9	14	15.29	0.70	16.24	0.73	17.19	0.75	17.88	0.76	19.09	0.77	20.04	0.79
		20	15.28	0.71	16.23	0.74	17.18	0.76	17.86	0.77	19.08	0.79	20.03	0.80
		25	15.27	0.72	16.22	0.75	17.17	0.77	17.85	0.78	19.06	0.80	20.01	0.81
		30	15.26	0.73	16.21	0.76	17.15	0.78	17.84	0.79	19.05	0.81	20.00	0.82
		35	15.25	0.74	16.19	0.77	17.14	0.79	17.82	0.80	19.03	0.82	19.98	0.84
		40	15.23	0.75	16.18	0.78	17.13	0.81	17.81	0.81	19.02	0.83	19.96	0.85
		45	15.22	0.76	16.17	0.79	17.11	0.82	17.80	0.83	19.00	0.84	19.95	0.86
		50	15.21	0.77	16.16	0.80	17.10	0.83	17.78	0.84	18.99	0.85	19.93	0.87
		55	15.20	0.78	16.14	0.81	17.09	0.84	17.77	0.85	18.98	0.86	19.92	0.88
		60	15.19	0.79	16.13	0.82	17.07	0.85	17.76	0.86	18.96	0.87	19.90	0.89
		65	15.18	0.80	16.12	0.83	17.06	0.86	17.74	0.87	18.95	0.89	19.89	0.90
		70	15.16	0.81	16.11	0.84	17.05	0.87	17.73	0.88	18.93	0.90	19.87	0.92
		75	14.80	0.85	15.74	0.89	16.68	0.92	17.36	0.93	18.56	0.95	19.50	0.96
		80	14.43	0.90	15.37	0.93	16.31	0.96	16.99	0.98	18.18	0.99	19.12	1.01
		85	14.07	0.94	15.01	0.98	15.94	1.01	16.62	1.02	17.81	1.04	18.75	1.06
		90	13.71	0.99	14.64	1.02	15.58	1.06	16.25	1.07	17.44	1.09	18.37	1.11
		95	13.32	1.03	14.25	1.07	15.17	1.11	<b>15.60</b>	<b>1.12</b>	17.03	1.14	17.96	1.16
		100	12.99	1.07	13.92	1.11	14.85	1.15	15.40	1.17	16.71	1.19	17.63	1.21
		105	12.67	1.12	13.60	1.16	14.53	1.20	15.20	1.21	16.38	1.24	17.31	1.26
		110	12.35	1.16	13.27	1.20	14.20	1.25	14.87	1.26	16.06	1.28	16.98	1.31
		115	12.02	1.20	12.95	1.25	13.88	1.29	14.55	1.31	15.73	1.33	16.66	1.36
		118	11.83	1.23	12.75	1.27	13.68	1.32	14.35	1.34	15.54	1.36	16.47	1.39
	122	11.76	1.26	12.69	1.31	13.62	1.36	14.29	1.37	15.47	1.40	16.40	1.43	
	9 + 12	14	15.29	0.70	16.24	0.73	17.19	0.75	17.88	0.76	19.09	0.77	20.04	0.79
		20	15.28	0.71	16.23	0.74	17.18	0.76	17.86	0.77	19.08	0.79	20.03	0.80
		25	15.27	0.72	16.22	0.75	17.17	0.77	17.85	0.78	19.06	0.80	20.01	0.81
		30	15.26	0.73	16.21	0.76	17.15	0.78	17.84	0.79	19.05	0.81	20.00	0.82
		35	15.25	0.74	16.19	0.77	17.14	0.79	17.82	0.80	19.03	0.82	19.98	0.84
		40	15.23	0.75	16.18	0.78	17.13	0.81	17.81	0.81	19.02	0.83	19.96	0.85
		45	15.22	0.76	16.17	0.79	17.11	0.82	17.80	0.83	19.00	0.84	19.95	0.86
		50	15.21	0.77	16.16	0.80	17.10	0.83	17.78	0.84	18.99	0.85	19.93	0.87
		55	15.20	0.78	16.14	0.81	17.09	0.84	17.77	0.85	18.98	0.86	19.92	0.88
		60	15.19	0.79	16.13	0.82	17.07	0.85	17.76	0.86	18.96	0.87	19.90	0.89
		65	15.18	0.80	16.12	0.83	17.06	0.86	17.74	0.87	18.95	0.89	19.89	0.90
		70	15.16	0.81	16.11	0.84	17.05	0.87	17.73	0.88	18.93	0.90	19.87	0.92
		75	14.80	0.85	15.74	0.89	16.68	0.92	17.36	0.93	18.56	0.95	19.50	0.96
		80	14.43	0.90	15.37	0.93	16.31	0.96	16.99	0.98	18.18	0.99	19.12	1.01
		85	14.07	0.94	15.01	0.98	15.94	1.01	16.62	1.02	17.81	1.04	18.75	1.06
		90	13.71	0.99	14.64	1.02	15.58	1.06	16.25	1.07	17.44	1.09	18.37	1.11
		95	13.32	1.03	14.25	1.07	15.17	1.11	<b>15.60</b>	<b>1.12</b>	17.03	1.14	17.96	1.16
		100	12.99	1.07	13.92	1.11	14.85	1.15	15.40	1.17	16.71	1.19	17.63	1.21
		105	12.67	1.12	13.60	1.16	14.53	1.20	15.20	1.21	16.38	1.24	17.31	1.26
		110	12.35	1.16	13.27	1.20	14.20	1.25	14.87	1.26	16.06	1.28	16.98	1.31
		115	12.02	1.20	12.95	1.25	13.88	1.29	14.55	1.31	15.73	1.33	16.66	1.36
118		11.83	1.23	12.75	1.27	13.68	1.32	14.35	1.34	15.54	1.36	16.47	1.39	
122	11.76	1.26	12.69	1.31	13.62	1.36	14.29	1.37	15.47	1.40	16.40	1.43		

TC = Total Capacity (kBtu/h).

PI = Power Input (kW).

Nominal capacity as rated: 0 ft. above sea level with 25 ft. of refrigerant piping.  
0 ft. level difference between outdoor and indoor units.

Nominal cooling capacity rating obtained with air entering the indoor unit at 80°F dry bulb (DB) and 67°F wet bulb (WB), and outdoor ambient conditions of 95°F dry bulb (DB) and 75°F wet bulb (WB).

The shaded table rows indicate reference data. When operating at this temperature, these values can be different if the system is not running consistently.

# PERFORMANCE DATA

## Cooling Capacity Tables

MULTI F  
MULTI F MAX

Table 24: LMU187HV Cooling Capacity Table—Non-Ducted (continued) / Ducted Indoor Units.

Connected Indoor Units	Combination Capacity Index	Outdoor Air Temp. (°F DB)	Indoor Air Temp. °F DB / °F WB											
			68 / 57		73 / 61		77 / 64		80 / 67		86 / 72		90 / 75	
			TC	PI	TC	PI	TC	PI	TC	PI	TC	PI	TC	PI
Two (2) Non-Ducted Indoor Units	12 + 12	14	15.29	0.70	16.24	0.73	17.19	0.75	17.88	0.76	19.09	0.77	20.04	0.79
		20	15.28	0.71	16.23	0.74	17.18	0.76	17.86	0.77	19.08	0.79	20.03	0.80
		25	15.27	0.72	16.22	0.75	17.17	0.77	17.85	0.78	19.06	0.80	20.01	0.81
		30	15.26	0.73	16.21	0.76	17.15	0.78	17.84	0.79	19.05	0.81	20.00	0.82
		35	15.25	0.74	16.19	0.77	17.14	0.79	17.82	0.80	19.03	0.82	19.98	0.84
		40	15.23	0.75	16.18	0.78	17.13	0.81	17.81	0.81	19.02	0.83	19.96	0.85
		45	15.22	0.76	16.17	0.79	17.11	0.82	17.80	0.83	19.00	0.84	19.95	0.86
		50	15.21	0.77	16.16	0.80	17.10	0.83	17.78	0.84	18.99	0.85	19.93	0.87
		55	15.20	0.78	16.14	0.81	17.09	0.84	17.77	0.85	18.98	0.86	19.92	0.88
		60	15.19	0.79	16.13	0.82	17.07	0.85	17.76	0.86	18.96	0.87	19.90	0.89
		65	15.18	0.80	16.12	0.83	17.06	0.86	17.74	0.87	18.95	0.89	19.89	0.90
		70	15.16	0.81	16.11	0.84	17.05	0.87	17.73	0.88	18.93	0.90	19.87	0.92
		75	14.80	0.85	15.74	0.89	16.68	0.92	17.36	0.93	18.56	0.95	19.50	0.96
		80	14.43	0.90	15.37	0.93	16.31	0.96	16.99	0.98	18.18	0.99	19.12	1.01
		85	14.07	0.94	15.01	0.98	15.94	1.01	16.62	1.02	17.81	1.04	18.75	1.06
		90	13.71	0.99	14.64	1.02	15.58	1.06	16.25	1.07	17.44	1.09	18.37	1.11
		95	13.32	1.03	14.25	1.07	15.17	1.11	<b>15.60</b>	<b>1.12</b>	17.03	1.14	17.96	1.16
		100	12.99	1.07	13.92	1.11	14.85	1.15	15.40	1.17	16.71	1.19	17.63	1.21
		105	12.67	1.12	13.60	1.16	14.53	1.20	15.20	1.21	16.38	1.24	17.31	1.26
		110	12.35	1.16	13.27	1.20	14.20	1.25	14.87	1.26	16.06	1.28	16.98	1.31
115	12.02	1.20	12.95	1.25	13.88	1.29	14.55	1.31	15.73	1.33	16.66	1.36		
118	11.83	1.23	12.75	1.27	13.68	1.32	14.35	1.34	15.54	1.36	16.47	1.39		
122	11.76	1.26	12.69	1.31	13.62	1.36	14.29	1.37	15.47	1.40	16.40	1.43		
Two (2) Ducted Indoor Units	9 + 9	14	14.51	0.78	15.41	0.81	16.31	0.84	16.96	0.85	18.11	0.86	19.01	0.88
		20	14.50	0.79	15.40	0.82	16.30	0.85	16.95	0.86	18.10	0.87	19.00	0.89
		25	14.49	0.80	15.39	0.83	16.29	0.86	16.94	0.87	18.08	0.89	18.98	0.90
		30	14.48	0.81	15.37	0.84	16.27	0.87	16.92	0.88	18.07	0.90	18.97	0.92
		35	14.46	0.82	15.36	0.85	16.26	0.88	16.91	0.89	18.06	0.91	18.96	0.93
		40	14.45	0.83	15.35	0.86	16.25	0.90	16.90	0.91	18.04	0.92	18.94	0.94
		45	14.44	0.85	15.34	0.88	16.24	0.91	16.88	0.92	18.03	0.94	18.93	0.95
		50	14.43	0.86	15.33	0.89	16.22	0.92	16.87	0.93	18.02	0.95	18.91	0.97
		55	14.42	0.87	15.32	0.90	16.21	0.93	16.86	0.94	18.00	0.96	18.90	0.98
		60	14.41	0.88	15.30	0.91	16.20	0.94	16.84	0.96	17.99	0.97	18.88	0.99
		65	14.40	0.89	15.29	0.92	16.19	0.96	16.83	0.97	17.97	0.99	18.87	1.01
		70	14.39	0.90	15.28	0.93	16.17	0.97	16.82	0.98	17.96	1.00	18.85	1.02
		75	14.04	0.95	14.93	0.98	15.82	1.02	16.47	1.03	17.61	1.05	18.50	1.07
		80	13.69	1.00	14.58	1.04	15.47	1.07	16.11	1.09	17.25	1.11	18.14	1.13
		85	13.35	1.05	14.24	1.09	15.12	1.13	15.77	1.14	16.90	1.16	17.79	1.18
		90	13.01	1.10	13.89	1.14	14.78	1.18	15.42	1.19	16.55	1.21	17.43	1.24
		95	12.64	1.14	13.52	1.19	14.40	1.23	<b>14.80</b>	<b>1.24</b>	16.16	1.27	17.04	1.29
		100	12.33	1.19	13.21	1.24	14.09	1.28	14.61	1.30	15.85	1.32	16.73	1.35
		105	12.02	1.24	12.90	1.29	13.78	1.33	14.42	1.35	15.54	1.37	16.42	1.40
		110	11.71	1.29	12.59	1.34	13.47	1.39	14.11	1.40	15.23	1.43	16.11	1.46
115	11.40	1.34	12.29	1.39	13.17	1.44	13.80	1.46	14.93	1.48	15.81	1.51		
118	11.22	1.37	12.10	1.42	12.98	1.47	13.62	1.49	14.74	1.51	15.62	1.55		
122	11.16	1.41	12.04	1.46	12.92	1.51	13.55	1.53	14.68	1.56	15.56	1.59		

TC = Total Capacity (kBtu/h).

PI = Power Input (kW).

Nominal capacity as rated: 0 ft. above sea level with 25 ft. of refrigerant piping.  
0 ft. level difference between outdoor and indoor units.

Nominal cooling capacity rating obtained with air entering the indoor unit at 80°F dry bulb (DB) and 67°F wet bulb (WB), and outdoor ambient conditions of 95°F dry bulb (DB) and 75°F wet bulb (WB).

The shaded table rows indicate reference data. When operating at this temperature, these values can be different if the system is not running consistently.



Multi F and Multi F MAX Heat Pump System Engineering Manual

Table 25: LMU187HV Cooling Capacity Table—Ducted Indoor Units (continued).

Connected Indoor Units	Combination Capacity Index	Outdoor Air Temp. (°F DB)	Indoor Air Temp. °F DB / °F WB											
			68 / 57		73 / 61		77 / 64		80 / 67		86 / 72		90 / 75	
			TC	PI	TC	PI	TC	PI	TC	PI	TC	PI	TC	PI
Two (2) Ducted Indoor Units	9 + 12	14	14.51	0.78	15.41	0.81	16.31	0.84	16.96	0.85	18.11	0.86	19.01	0.88
		20	14.50	0.79	15.40	0.82	16.30	0.85	16.95	0.86	18.10	0.87	19.00	0.89
		25	14.49	0.80	15.39	0.83	16.29	0.86	16.94	0.87	18.08	0.89	18.98	0.90
		30	14.48	0.81	15.37	0.84	16.27	0.87	16.92	0.88	18.07	0.90	18.97	0.92
		35	14.46	0.82	15.36	0.85	16.26	0.88	16.91	0.89	18.06	0.91	18.96	0.93
		40	14.45	0.83	15.35	0.86	16.25	0.90	16.90	0.91	18.04	0.92	18.94	0.94
		45	14.44	0.85	15.34	0.88	16.24	0.91	16.88	0.92	18.03	0.94	18.93	0.95
		50	14.43	0.86	15.33	0.89	16.22	0.92	16.87	0.93	18.02	0.95	18.91	0.97
		55	14.42	0.87	15.32	0.90	16.21	0.93	16.86	0.94	18.00	0.96	18.90	0.98
		60	14.41	0.88	15.30	0.91	16.20	0.94	16.84	0.96	17.99	0.97	18.88	0.99
		65	14.40	0.89	15.29	0.92	16.19	0.96	16.83	0.97	17.97	0.99	18.87	1.01
		70	14.39	0.90	15.28	0.93	16.17	0.97	16.82	0.98	17.96	1.00	18.85	1.02
		75	14.04	0.95	14.93	0.98	15.82	1.02	16.47	1.03	17.61	1.05	18.50	1.07
		80	13.69	1.00	14.58	1.04	15.47	1.07	16.11	1.09	17.25	1.11	18.14	1.13
		85	13.35	1.05	14.24	1.09	15.12	1.13	15.77	1.14	16.90	1.16	17.79	1.18
		90	13.01	1.10	13.89	1.14	14.78	1.18	15.42	1.19	16.55	1.21	17.43	1.24
		95	12.64	1.14	13.52	1.19	14.40	1.23	<b>14.80</b>	<b>1.24</b>	16.16	1.27	17.04	1.29
		100	12.33	1.19	13.21	1.24	14.09	1.28	14.61	1.30	15.85	1.32	16.73	1.35
	105	12.02	1.24	12.90	1.29	13.78	1.33	14.42	1.35	15.54	1.37	16.42	1.40	
	110	11.71	1.29	12.59	1.34	13.47	1.39	14.11	1.40	15.23	1.43	16.11	1.46	
	115	11.40	1.34	12.29	1.39	13.17	1.44	13.80	1.46	14.93	1.48	15.81	1.51	
	118	11.22	1.37	12.10	1.42	12.98	1.47	13.62	1.49	14.74	1.51	15.62	1.55	
	122	11.16	1.41	12.04	1.46	12.92	1.51	13.55	1.53	14.68	1.56	15.56	1.59	
	12 + 12	14	14.51	0.78	15.41	0.81	16.31	0.84	16.96	0.85	18.11	0.86	19.01	0.88
		20	14.50	0.79	15.40	0.82	16.30	0.85	16.95	0.86	18.10	0.87	19.00	0.89
		25	14.49	0.80	15.39	0.83	16.29	0.86	16.94	0.87	18.08	0.89	18.98	0.90
		30	14.48	0.81	15.37	0.84	16.27	0.87	16.92	0.88	18.07	0.90	18.97	0.92
		35	14.46	0.82	15.36	0.85	16.26	0.88	16.91	0.89	18.06	0.91	18.96	0.93
		40	14.45	0.83	15.35	0.86	16.25	0.90	16.90	0.91	18.04	0.92	18.94	0.94
		45	14.44	0.85	15.34	0.88	16.24	0.91	16.88	0.92	18.03	0.94	18.93	0.95
		50	14.43	0.86	15.33	0.89	16.22	0.92	16.87	0.93	18.02	0.95	18.91	0.97
		55	14.42	0.87	15.32	0.90	16.21	0.93	16.86	0.94	18.00	0.96	18.90	0.98
		60	14.41	0.88	15.30	0.91	16.20	0.94	16.84	0.96	17.99	0.97	18.88	0.99
		65	14.40	0.89	15.29	0.92	16.19	0.96	16.83	0.97	17.97	0.99	18.87	1.01
		70	14.39	0.90	15.28	0.93	16.17	0.97	16.82	0.98	17.96	1.00	18.85	1.02
		75	14.04	0.95	14.93	0.98	15.82	1.02	16.47	1.03	17.61	1.05	18.50	1.07
80		13.69	1.00	14.58	1.04	15.47	1.07	16.11	1.09	17.25	1.11	18.14	1.13	
85		13.35	1.05	14.24	1.09	15.12	1.13	15.77	1.14	16.90	1.16	17.79	1.18	
90		13.01	1.10	13.89	1.14	14.78	1.18	15.42	1.19	16.55	1.21	17.43	1.24	
95		12.64	1.14	13.52	1.19	14.40	1.23	<b>14.80</b>	<b>1.24</b>	16.16	1.27	17.04	1.29	
100		12.33	1.19	13.21	1.24	14.09	1.28	14.61	1.30	15.85	1.32	16.73	1.35	
105	12.02	1.24	12.90	1.29	13.78	1.33	14.42	1.35	15.54	1.37	16.42	1.40		
110	11.71	1.29	12.59	1.34	13.47	1.39	14.11	1.40	15.23	1.43	16.11	1.46		
115	11.40	1.34	12.29	1.39	13.17	1.44	13.80	1.46	14.93	1.48	15.81	1.51		
118	11.22	1.37	12.10	1.42	12.98	1.47	13.62	1.49	14.74	1.51	15.62	1.55		
122	11.16	1.41	12.04	1.46	12.92	1.51	13.55	1.53	14.68	1.56	15.56	1.59		

TC = Total Capacity (kBtu/h).

PI = Power Input (kW).

Nominal capacity as rated: 0 ft. above sea level with 25 ft. of refrigerant piping.  
0 ft. level difference between outdoor and indoor units.

Nominal cooling capacity rating obtained with air entering the indoor unit at 80°F dry bulb (DB) and 67°F wet bulb (WB), and outdoor ambient conditions of 95°F dry bulb (DB) and 75°F wet bulb (WB).

The shaded table rows indicate reference data. When operating at this temperature, these values can be different if the system is not running consistently.

# PERFORMANCE DATA

## Cooling Capacity Tables

MULTI F  
MULTI F MAX

Table 26: LMU187HV Cooling Capacity Table—Mixed Indoor Units.

Connected Indoor Units	Combination Capacity Index	Outdoor Air Temp. (°F DB)	Indoor Air Temp. °F DB / °F WB											
			68 / 57		73 / 61		77 / 64		80 / 67		86 / 72		90 / 75	
			TC	PI	TC	PI	TC	PI	TC	PI	TC	PI	TC	PI
Two (2) Mixed Indoor Units	9 + 9	14	14.90	0.74	15.83	0.77	16.75	0.79	17.42	0.80	18.60	0.82	19.53	0.83
		20	14.89	0.75	15.81	0.78	16.74	0.81	17.41	0.81	18.59	0.83	19.51	0.85
		25	14.88	0.76	15.80	0.79	16.73	0.82	17.39	0.83	18.57	0.84	19.50	0.86
		30	14.87	0.77	15.79	0.80	16.71	0.83	17.38	0.84	18.56	0.85	19.48	0.87
		35	14.86	0.78	15.78	0.81	16.70	0.84	17.37	0.85	18.55	0.87	19.47	0.88
		40	14.84	0.79	15.77	0.82	16.69	0.85	17.35	0.86	18.53	0.88	19.45	0.89
		45	14.83	0.80	15.75	0.83	16.67	0.86	17.34	0.87	18.52	0.89	19.44	0.91
		50	14.82	0.81	15.74	0.84	16.66	0.87	17.33	0.88	18.50	0.90	19.42	0.92
		55	14.81	0.82	15.73	0.85	16.65	0.89	17.31	0.90	18.49	0.91	19.41	0.93
		60	14.80	0.83	15.72	0.87	16.64	0.90	17.30	0.91	18.47	0.92	19.39	0.94
		65	14.79	0.85	15.71	0.88	16.62	0.91	17.29	0.92	18.46	0.94	19.38	0.95
		70	14.78	0.86	15.69	0.89	16.61	0.92	17.27	0.93	18.45	0.95	19.36	0.97
		75	14.42	0.90	15.34	0.93	16.25	0.97	16.91	0.98	18.08	1.00	19.00	1.02
		80	14.06	0.95	14.98	0.98	15.89	1.02	16.55	1.03	17.72	1.05	18.63	1.07
		85	13.71	0.99	14.62	1.03	15.53	1.07	16.19	1.08	17.36	1.10	18.27	1.12
		90	13.36	1.04	14.27	1.08	15.18	1.12	15.83	1.13	16.99	1.15	17.90	1.18
		95	12.98	1.09	13.88	1.13	14.79	1.17	<b>15.20</b>	<b>1.18</b>	16.59	1.20	17.50	1.23
		100	12.66	1.13	13.57	1.17	14.47	1.22	15.00	1.23	16.28	1.25	17.18	1.28
		105	12.35	1.18	13.25	1.22	14.15	1.27	14.81	1.28	15.96	1.31	16.87	1.33
		110	12.03	1.23	12.93	1.27	13.84	1.32	14.49	1.33	15.65	1.36	16.55	1.38
		115	11.71	1.27	12.62	1.32	13.52	1.37	14.17	1.38	15.33	1.41	16.23	1.44
	118	11.52	1.30	12.43	1.35	13.33	1.40	13.98	1.41	15.14	1.44	16.04	1.47	
	122	11.46	1.34	12.36	1.38	13.27	1.44	13.92	1.45	15.08	1.48	15.98	1.51	
	9 + 12	14	14.90	0.74	15.83	0.77	16.75	0.79	17.42	0.80	18.60	0.82	19.53	0.83
		20	14.89	0.75	15.81	0.78	16.74	0.81	17.41	0.81	18.59	0.83	19.51	0.85
		25	14.88	0.76	15.80	0.79	16.73	0.82	17.39	0.83	18.57	0.84	19.50	0.86
		30	14.87	0.77	15.79	0.80	16.71	0.83	17.38	0.84	18.56	0.85	19.48	0.87
		35	14.86	0.78	15.78	0.81	16.70	0.84	17.37	0.85	18.55	0.87	19.47	0.88
		40	14.84	0.79	15.77	0.82	16.69	0.85	17.35	0.86	18.53	0.88	19.45	0.89
		45	14.83	0.80	15.75	0.83	16.67	0.86	17.34	0.87	18.52	0.89	19.44	0.91
		50	14.82	0.81	15.74	0.84	16.66	0.87	17.33	0.88	18.50	0.90	19.42	0.92
		55	14.81	0.82	15.73	0.85	16.65	0.89	17.31	0.90	18.49	0.91	19.41	0.93
		60	14.80	0.83	15.72	0.87	16.64	0.90	17.30	0.91	18.47	0.92	19.39	0.94
		65	14.79	0.85	15.71	0.88	16.62	0.91	17.29	0.92	18.46	0.94	19.38	0.95
		70	14.78	0.86	15.69	0.89	16.61	0.92	17.27	0.93	18.45	0.95	19.36	0.97
		75	14.42	0.90	15.34	0.93	16.25	0.97	16.91	0.98	18.08	1.00	19.00	1.02
		80	14.06	0.95	14.98	0.98	15.89	1.02	16.55	1.03	17.72	1.05	18.63	1.07
		85	13.71	0.99	14.62	1.03	15.53	1.07	16.19	1.08	17.36	1.10	18.27	1.12
		90	13.36	1.04	14.27	1.08	15.18	1.12	15.83	1.13	16.99	1.15	17.90	1.18
		95	12.98	1.09	13.88	1.13	14.79	1.17	<b>15.20</b>	<b>1.18</b>	16.59	1.20	17.50	1.23
		100	12.66	1.13	13.57	1.17	14.47	1.22	15.00	1.23	16.28	1.25	17.18	1.28
		105	12.35	1.18	13.25	1.22	14.15	1.27	14.81	1.28	15.96	1.31	16.87	1.33
110		12.03	1.23	12.93	1.27	13.84	1.32	14.49	1.33	15.65	1.36	16.55	1.38	
115		11.71	1.27	12.62	1.32	13.52	1.37	14.17	1.38	15.33	1.41	16.23	1.44	
118	11.52	1.30	12.43	1.35	13.33	1.40	13.98	1.41	15.14	1.44	16.04	1.47		
122	11.46	1.34	12.36	1.38	13.27	1.44	13.92	1.45	15.08	1.48	15.98	1.51		

TC = Total Capacity (kBtu/h).

PI = Power Input (kW).

Nominal capacity as rated: 0 ft. above sea level with 25 ft. of refrigerant piping.  
0 ft. level difference between outdoor and indoor units.

Nominal cooling capacity rating obtained with air entering the indoor unit at 80°F dry bulb (DB) and 67°F wet bulb (WB), and outdoor ambient conditions of 95°F dry bulb (DB) and 75°F wet bulb (WB).

The shaded table rows indicate reference data. When operating at this temperature, these values can be different if the system is not running consistently.



Multi F and Multi F MAX Heat Pump System Engineering Manual

Table 27: LMU187HV Cooling Capacity Table—Mixed Indoor Units (continued).

Connected Indoor Units	Combination Capacity Index	Outdoor Air Temp. (°F DB)	Indoor Air Temp. °F DB / °F WB											
			68 / 57		73 / 61		77 / 64		80 / 67		86 / 72		90 / 75	
			TC	PI	TC	PI	TC	PI	TC	PI	TC	PI	TC	PI
Two (2) Mixed Indoor Units	12 + 12	14	14.90	0.74	15.83	0.77	16.75	0.79	17.42	0.80	18.60	0.82	19.53	0.83
		20	14.89	0.75	15.81	0.78	16.74	0.81	17.41	0.81	18.59	0.83	19.51	0.85
		25	14.88	0.76	15.80	0.79	16.73	0.82	17.39	0.83	18.57	0.84	19.50	0.86
		30	14.87	0.77	15.79	0.80	16.71	0.83	17.38	0.84	18.56	0.85	19.48	0.87
		35	14.86	0.78	15.78	0.81	16.70	0.84	17.37	0.85	18.55	0.87	19.47	0.88
		40	14.84	0.79	15.77	0.82	16.69	0.85	17.35	0.86	18.53	0.88	19.45	0.89
		45	14.83	0.80	15.75	0.83	16.67	0.86	17.34	0.87	18.52	0.89	19.44	0.91
		50	14.82	0.81	15.74	0.84	16.66	0.87	17.33	0.88	18.50	0.90	19.42	0.92
		55	14.81	0.82	15.73	0.85	16.65	0.89	17.31	0.90	18.49	0.91	19.41	0.93
		60	14.80	0.83	15.72	0.87	16.64	0.90	17.30	0.91	18.47	0.92	19.39	0.94
		65	14.79	0.85	15.71	0.88	16.62	0.91	17.29	0.92	18.46	0.94	19.38	0.95
		70	14.78	0.86	15.69	0.89	16.61	0.92	17.27	0.93	18.45	0.95	19.36	0.97
		75	14.42	0.90	15.34	0.93	16.25	0.97	16.91	0.98	18.08	1.00	19.00	1.02
		80	14.06	0.95	14.98	0.98	15.89	1.02	16.55	1.03	17.72	1.05	18.63	1.07
		85	13.71	0.99	14.62	1.03	15.53	1.07	16.19	1.08	17.36	1.10	18.27	1.12
		90	13.36	1.04	14.27	1.08	15.18	1.12	15.83	1.13	16.99	1.15	17.90	1.18
		95	12.98	1.09	13.88	1.13	14.79	1.17	<b>15.20</b>	<b>1.18</b>	16.59	1.20	17.50	1.23
		100	12.66	1.13	13.57	1.17	14.47	1.22	15.00	1.23	16.28	1.25	17.18	1.28
		105	12.35	1.18	13.25	1.22	14.15	1.27	14.81	1.28	15.96	1.31	16.87	1.33
110	12.03	1.23	12.93	1.27	13.84	1.32	14.49	1.33	15.65	1.36	16.55	1.38		
115	11.71	1.27	12.62	1.32	13.52	1.37	14.17	1.38	15.33	1.41	16.23	1.44		
118	11.52	1.30	12.43	1.35	13.33	1.40	13.98	1.41	15.14	1.44	16.04	1.47		
122	11.46	1.34	12.36	1.38	13.27	1.44	13.92	1.45	15.08	1.48	15.98	1.51		

TC = Total Capacity (kBtu/h).

PI = Power Input (kW).

Nominal capacity as rated: 0 ft. above sea level with 25 ft. of refrigerant piping.  
0 ft. level difference between outdoor and indoor units.

Nominal cooling capacity rating obtained with air entering the indoor unit at 80°F dry bulb (DB) and 67°F wet bulb (WB), and outdoor ambient conditions of 95°F dry bulb (DB) and 75°F wet bulb (WB).

The shaded table rows indicate reference data. When operating at this temperature, these values can be different if the system is not running consistently.

# PERFORMANCE DATA

## Cooling Capacity Tables

MULTI F  
MULTI F MAX

Table 28: LMU247HV Cooling Capacity Table — Non-Ducted Indoor Units.

Connected Indoor Units	Combination Capacity Index	Outdoor Air Temp. (°F DB)	Indoor Air Temp. °F DB / °F WB											
			68 / 57		73 / 61		77 / 64		80 / 67		86 / 72		90 / 75	
			TC	PI	TC	PI	TC	PI	TC	PI	TC	PI	TC	PI
Two (2) Non-Ducted Indoor Units	9 + 9	14	16.67	0.84	17.70	0.88	18.74	0.91	19.48	0.92	20.80	0.93	21.84	0.95
		20	16.65	0.86	17.69	0.89	18.72	0.92	19.47	0.93	20.79	0.95	21.82	0.97
		25	16.64	0.87	17.67	0.90	18.71	0.93	19.45	0.94	20.77	0.96	21.81	0.98
		30	16.63	0.88	17.66	0.91	18.69	0.95	19.44	0.96	20.76	0.97	21.79	0.99
		35	16.61	0.89	17.65	0.93	18.68	0.96	19.42	0.97	20.74	0.99	21.77	1.01
		40	16.60	0.90	17.63	0.94	18.66	0.97	19.41	0.98	20.73	1.00	21.76	1.02
		45	16.59	0.92	17.62	0.95	18.65	0.99	19.39	1.00	20.71	1.02	21.74	1.04
		50	16.58	0.93	17.61	0.96	18.63	1.00	19.38	1.01	20.69	1.03	21.72	1.05
		55	16.56	0.94	17.59	0.98	18.62	1.01	19.36	1.02	20.68	1.04	21.71	1.06
		60	16.55	0.95	17.58	0.99	18.61	1.02	19.35	1.04	20.66	1.06	21.69	1.08
		65	16.54	0.97	17.57	1.00	18.59	1.04	19.33	1.05	20.65	1.07	21.67	1.09
		70	16.53	0.98	17.55	1.01	18.58	1.05	19.32	1.06	20.63	1.08	21.66	1.10
		75	16.13	1.03	17.15	1.07	18.18	1.11	18.91	1.12	20.22	1.14	21.25	1.16
		80	15.73	1.08	16.75	1.12	17.77	1.16	18.51	1.18	19.81	1.20	20.84	1.22
		85	15.34	1.14	16.35	1.18	17.37	1.22	18.11	1.23	19.41	1.26	20.43	1.28
		90	14.94	1.19	15.96	1.23	16.97	1.28	17.71	1.29	19.01	1.32	20.02	1.34
		95	14.51	1.24	15.52	1.29	16.54	1.33	<b>17.00</b>	<b>1.35</b>	18.56	1.37	19.57	1.40
		100	14.16	1.29	15.17	1.34	16.18	1.39	16.78	1.41	18.20	1.43	19.22	1.46
	105	13.81	1.35	14.82	1.40	15.83	1.45	16.56	1.46	17.85	1.49	18.86	1.52	
	110	13.45	1.40	14.46	1.45	15.48	1.50	16.21	1.52	17.50	1.55	18.51	1.58	
	115	13.10	1.45	14.11	1.51	15.12	1.56	15.85	1.58	17.14	1.61	18.16	1.64	
	118	12.89	1.48	13.90	1.54	14.91	1.59	15.64	1.61	16.93	1.64	17.94	1.68	
	122	12.82	1.53	13.83	1.58	14.84	1.64	15.57	1.66	16.86	1.69	17.87	1.72	
	9 + 12	14	17.35	0.87	18.43	0.90	19.51	0.93	20.28	0.94	21.66	0.96	22.74	0.98
		20	17.34	0.88	18.41	0.91	19.49	0.94	20.27	0.95	21.65	0.97	22.72	0.99
		25	17.32	0.89	18.40	0.92	19.48	0.96	20.25	0.97	21.63	0.99	22.70	1.01
		30	17.31	0.90	18.39	0.94	19.46	0.97	20.24	0.98	21.61	1.00	22.69	1.02
		35	17.30	0.92	18.37	0.95	19.45	0.98	20.22	0.99	21.60	1.01	22.67	1.03
		40	17.29	0.93	18.36	0.96	19.43	1.00	20.21	1.01	21.58	1.03	22.65	1.05
		45	17.27	0.94	18.34	0.97	19.42	1.01	20.19	1.02	21.56	1.04	22.64	1.06
		50	17.26	0.95	18.33	0.99	19.40	1.02	20.18	1.04	21.55	1.05	22.62	1.08
		55	17.25	0.96	18.32	1.00	19.39	1.04	20.16	1.05	21.53	1.07	22.60	1.09
		60	17.23	0.98	18.30	1.01	19.37	1.05	20.15	1.06	21.51	1.08	22.58	1.10
		65	17.22	0.99	18.29	1.03	19.36	1.06	20.13	1.08	21.50	1.10	22.57	1.12
		70	17.21	1.00	18.27	1.04	19.34	1.08	20.11	1.09	21.48	1.11	22.55	1.13
		75	16.79	1.06	17.86	1.09	18.92	1.13	19.69	1.15	21.06	1.17	22.12	1.19
		80	16.38	1.11	17.44	1.15	18.50	1.19	19.27	1.21	20.63	1.23	21.69	1.25
	85	15.97	1.16	17.03	1.21	18.09	1.25	18.85	1.27	20.21	1.29	21.27	1.32	
	90	15.56	1.22	16.61	1.26	17.67	1.31	18.44	1.32	19.79	1.35	20.85	1.38	
	95	15.11	1.27	16.16	1.32	17.22	1.37	<b>17.70</b>	<b>1.38</b>	19.32	1.41	20.38	1.44	
	100	14.74	1.33	15.80	1.38	16.85	1.43	17.47	1.44	18.95	1.47	20.01	1.50	
	105	14.38	1.38	15.43	1.43	16.48	1.48	17.24	1.50	18.59	1.53	19.64	1.56	
110	14.01	1.43	15.06	1.49	16.11	1.54	16.87	1.56	18.22	1.59	19.27	1.62		
115	13.64	1.49	14.69	1.54	15.75	1.60	16.51	1.62	17.85	1.65	18.90	1.68		
118	13.42	1.52	14.47	1.58	15.52	1.63	16.28	1.65	17.63	1.68	18.68	1.72		
122	13.35	1.56	14.40	1.62	15.45	1.68	16.21	1.70	17.56	1.73	18.61	1.77		

TC = Total Capacity (kBtu/h).

PI = Power Input (kW).

Nominal capacity as rated: 0 ft. above sea level with 25 ft. of refrigerant piping.  
0 ft. level difference between outdoor and indoor units.

Nominal cooling capacity rating obtained with air entering the indoor unit at 80°F dry bulb (DB) and 67°F wet bulb (WB), and outdoor ambient conditions of 95°F dry bulb (DB) and 75°F wet bulb (WB).

The shaded table rows indicate reference data. When operating at this temperature, these values can be different if the system is not running consistently.

Multi F and Multi F MAX Heat Pump System Engineering Manual

Table 29: LMU247HV Cooling Capacity Table — Non-Ducted Indoor Units (continued).

Connected Indoor Units	Combination Capacity Index	Outdoor Air Temp. (°F DB)	Indoor Air Temp. °F DB / °F WB											
			68 / 57		73 / 61		77 / 64		80 / 67		86 / 72		90 / 75	
			TC	PI	TC	PI	TC	PI	TC	PI	TC	PI	TC	PI
Two (2) Non-Ducted Indoor Units	12 + 12	14	18.82	0.92	19.99	0.95	21.16	0.99	22.00	1.00	23.50	1.02	24.67	1.04
		20	18.81	0.93	19.98	0.97	21.14	1.00	21.99	1.01	23.48	1.03	24.65	1.05
		25	18.79	0.95	19.96	0.98	21.13	1.02	21.97	1.03	23.46	1.05	24.63	1.07
		30	18.78	0.96	19.94	0.99	21.11	1.03	21.95	1.04	23.44	1.06	24.61	1.08
		35	18.76	0.97	19.93	1.01	21.09	1.04	21.94	1.06	23.43	1.08	24.59	1.10
		40	18.75	0.99	19.91	1.02	21.08	1.06	21.92	1.07	23.41	1.09	24.57	1.11
		45	18.74	1.00	19.90	1.04	21.06	1.07	21.90	1.09	23.39	1.11	24.55	1.13
		50	18.72	1.01	19.88	1.05	21.05	1.09	21.89	1.10	23.37	1.12	24.53	1.14
		55	18.71	1.02	19.87	1.06	21.03	1.10	21.87	1.11	23.35	1.13	24.52	1.16
		60	18.69	1.04	19.85	1.08	21.01	1.12	21.85	1.13	23.34	1.15	24.50	1.17
		65	18.68	1.05	19.84	1.09	21.00	1.13	21.84	1.14	23.32	1.16	24.48	1.19
		70	18.66	1.06	19.82	1.10	20.98	1.14	21.82	1.16	23.30	1.18	24.46	1.20
	75	18.21	1.12	19.37	1.16	20.53	1.21	21.36	1.22	22.84	1.24	24.00	1.27	
	80	17.77	1.18	18.92	1.22	20.07	1.27	20.91	1.28	22.38	1.31	23.53	1.33	
	85	17.32	1.24	18.47	1.28	19.62	1.33	20.45	1.34	21.92	1.37	23.07	1.40	
	90	16.88	1.29	18.02	1.34	19.17	1.39	20.00	1.41	21.47	1.43	22.61	1.46	
	95	16.39	1.35	17.53	1.40	18.68	1.45	19.20	1.47	20.96	1.50	22.10	1.53	
	100	15.99	1.41	17.13	1.46	18.28	1.51	18.95	1.53	20.56	1.56	21.70	1.59	
	105	15.59	1.47	16.74	1.52	17.88	1.58	18.70	1.59	20.16	1.62	21.30	1.66	
	110	15.19	1.52	16.34	1.58	17.48	1.64	18.30	1.66	19.76	1.69	20.90	1.72	
	115	14.80	1.58	15.94	1.64	17.08	1.70	17.90	1.72	19.36	1.75	20.51	1.79	
	118	14.56	1.62	15.70	1.67	16.84	1.74	17.66	1.76	19.12	1.79	20.27	1.82	
	122	14.48	1.66	15.62	1.72	16.76	1.79	17.58	1.81	19.04	1.84	20.19	1.88	
	9 + 18	14	18.82	0.92	19.99	0.95	21.16	0.99	22.00	1.00	23.50	1.02	24.67	1.04
20		18.81	0.93	19.98	0.97	21.14	1.00	21.99	1.01	23.48	1.03	24.65	1.05	
25		18.79	0.95	19.96	0.98	21.13	1.02	21.97	1.03	23.46	1.05	24.63	1.07	
30		18.78	0.96	19.94	0.99	21.11	1.03	21.95	1.04	23.44	1.06	24.61	1.08	
35		18.76	0.97	19.93	1.01	21.09	1.04	21.94	1.06	23.43	1.08	24.59	1.10	
40		18.75	0.99	19.91	1.02	21.08	1.06	21.92	1.07	23.41	1.09	24.57	1.11	
45		18.74	1.00	19.90	1.04	21.06	1.07	21.90	1.09	23.39	1.11	24.55	1.13	
50		18.72	1.01	19.88	1.05	21.05	1.09	21.89	1.10	23.37	1.12	24.53	1.14	
55		18.71	1.02	19.87	1.06	21.03	1.10	21.87	1.11	23.35	1.13	24.52	1.16	
60		18.69	1.04	19.85	1.08	21.01	1.12	21.85	1.13	23.34	1.15	24.50	1.17	
65		18.68	1.05	19.84	1.09	21.00	1.13	21.84	1.14	23.32	1.16	24.48	1.19	
70		18.66	1.06	19.82	1.10	20.98	1.14	21.82	1.16	23.30	1.18	24.46	1.20	
75	18.21	1.12	19.37	1.16	20.53	1.21	21.36	1.22	22.84	1.24	24.00	1.27		
80	17.77	1.18	18.92	1.22	20.07	1.27	20.91	1.28	22.38	1.31	23.53	1.33		
85	17.32	1.24	18.47	1.28	19.62	1.33	20.45	1.34	21.92	1.37	23.07	1.40		
90	16.88	1.29	18.02	1.34	19.17	1.39	20.00	1.41	21.47	1.43	22.61	1.46		
95	16.39	1.35	17.53	1.40	18.68	1.45	19.20	1.47	20.96	1.50	22.10	1.53		
100	15.99	1.41	17.13	1.46	18.28	1.51	18.95	1.53	20.56	1.56	21.70	1.59		
105	15.59	1.47	16.74	1.52	17.88	1.58	18.70	1.59	20.16	1.62	21.30	1.66		
110	15.19	1.52	16.34	1.58	17.48	1.64	18.30	1.66	19.76	1.69	20.90	1.72		
115	14.80	1.58	15.94	1.64	17.08	1.70	17.90	1.72	19.36	1.75	20.51	1.79		
118	14.56	1.62	15.70	1.67	16.84	1.74	17.66	1.76	19.12	1.79	20.27	1.82		
122	14.48	1.66	15.62	1.72	16.76	1.79	17.58	1.81	19.04	1.84	20.19	1.88		

TC = Total Capacity (kBtu/h).

PI = Power Input (kW).

Nominal capacity as rated: 0 ft. above sea level with 25 ft. of refrigerant piping.  
0 ft. level difference between outdoor and indoor units.

Nominal cooling capacity rating obtained with air entering the indoor unit at 80°F dry bulb (DB) and 67°F wet bulb (WB), and outdoor ambient conditions of 95°F dry bulb (DB) and 75°F wet bulb (WB).

The shaded table rows indicate reference data. When operating at this temperature, these values can be different if the system is not running consistently.

# PERFORMANCE DATA

## Cooling Capacity Tables

MULTI F  
MULTI F MAX

Table 30: LMU247HV Cooling Capacity Table — Non-Ducted Indoor Units (continued).

Connected Indoor Units	Combination Capacity Index	Outdoor Air Temp. (°F DB)	Indoor Air Temp. °F DB / °F WB											
			68 / 57		73 / 61		77 / 64		80 / 67		86 / 72		90 / 75	
			TC	PI	TC	PI	TC	PI	TC	PI	TC	PI	TC	PI
Two (2) Non-Ducted Indoor Units	12 + 18	14	18.82	0.92	19.99	0.95	21.16	0.99	22.00	1.00	23.50	1.02	24.67	1.04
		20	18.81	0.93	19.98	0.97	21.14	1.00	21.99	1.01	23.48	1.03	24.65	1.05
		25	18.79	0.95	19.96	0.98	21.13	1.02	21.97	1.03	23.46	1.05	24.63	1.07
		30	18.78	0.96	19.94	0.99	21.11	1.03	21.95	1.04	23.44	1.06	24.61	1.08
		35	18.76	0.97	19.93	1.01	21.09	1.04	21.94	1.06	23.43	1.08	24.59	1.10
		40	18.75	0.99	19.91	1.02	21.08	1.06	21.92	1.07	23.41	1.09	24.57	1.11
		45	18.74	1.00	19.90	1.04	21.06	1.07	21.90	1.09	23.39	1.11	24.55	1.13
		50	18.72	1.01	19.88	1.05	21.05	1.09	21.89	1.10	23.37	1.12	24.53	1.14
		55	18.71	1.02	19.87	1.06	21.03	1.10	21.87	1.11	23.35	1.13	24.52	1.16
		60	18.69	1.04	19.85	1.08	21.01	1.12	21.85	1.13	23.34	1.15	24.50	1.17
		65	18.68	1.05	19.84	1.09	21.00	1.13	21.84	1.14	23.32	1.16	24.48	1.19
		70	18.66	1.06	19.82	1.10	20.98	1.14	21.82	1.16	23.30	1.18	24.46	1.20
		75	18.21	1.12	19.37	1.16	20.53	1.21	21.36	1.22	22.84	1.24	24.00	1.27
		80	17.77	1.18	18.92	1.22	20.07	1.27	20.91	1.28	22.38	1.31	23.53	1.33
		85	17.32	1.24	18.47	1.28	19.62	1.33	20.45	1.34	21.92	1.37	23.07	1.40
		90	16.88	1.29	18.02	1.34	19.17	1.39	20.00	1.41	21.47	1.43	22.61	1.46
		95	16.39	1.35	17.53	1.40	18.68	1.45	<b>19.20</b>	<b>1.47</b>	20.96	1.50	22.10	1.53
		100	15.99	1.41	17.13	1.46	18.28	1.51	18.95	1.53	20.56	1.56	21.70	1.59
		105	15.59	1.47	16.74	1.52	17.88	1.58	18.70	1.59	20.16	1.62	21.30	1.66
		110	15.19	1.52	16.34	1.58	17.48	1.64	18.30	1.66	19.76	1.69	20.90	1.72
		115	14.80	1.58	15.94	1.64	17.08	1.70	17.90	1.72	19.36	1.75	20.51	1.79
		118	14.56	1.62	15.70	1.67	16.84	1.74	17.66	1.76	19.12	1.79	20.27	1.82
122	14.48	1.66	15.62	1.72	16.76	1.79	17.58	1.81	19.04	1.84	20.19	1.88		
Three (3) Non-Ducted Indoor Units	9 + 9 + 9	14	18.82	0.90	19.99	0.93	21.16	0.96	22.00	0.97	23.50	0.99	24.67	1.01
		20	18.81	0.91	19.98	0.94	21.14	0.98	21.99	0.99	23.48	1.01	24.65	1.03
		25	18.79	0.92	19.96	0.95	21.13	0.99	21.97	1.00	23.46	1.02	24.63	1.04
		30	18.78	0.93	19.94	0.97	21.11	1.00	21.95	1.02	23.44	1.03	24.61	1.05
		35	18.76	0.95	19.93	0.98	21.09	1.02	21.94	1.03	23.43	1.05	24.59	1.07
		40	18.75	0.96	19.91	0.99	21.08	1.03	21.92	1.04	23.41	1.06	24.57	1.08
		45	18.74	0.97	19.90	1.01	21.06	1.05	21.90	1.06	23.39	1.08	24.55	1.10
		50	18.72	0.99	19.88	1.02	21.05	1.06	21.89	1.07	23.37	1.09	24.53	1.11
		55	18.71	1.00	19.87	1.03	21.03	1.07	21.87	1.09	23.35	1.11	24.52	1.13
		60	18.69	1.01	19.85	1.05	21.01	1.09	21.85	1.10	23.34	1.12	24.50	1.14
		65	18.68	1.02	19.84	1.06	21.00	1.10	21.84	1.11	23.32	1.13	24.48	1.16
		70	18.66	1.04	19.82	1.07	20.98	1.11	21.82	1.13	23.30	1.15	24.46	1.17
		75	18.21	1.09	19.37	1.13	20.53	1.17	21.36	1.19	22.84	1.21	24.00	1.23
		80	17.77	1.15	18.92	1.19	20.07	1.23	20.91	1.25	22.38	1.27	23.53	1.30
		85	17.32	1.20	18.47	1.25	19.62	1.29	20.45	1.31	21.92	1.33	23.07	1.36
		90	16.88	1.26	18.02	1.31	19.17	1.35	20.00	1.37	21.47	1.40	22.61	1.42
		95	16.39	1.32	17.53	1.36	18.68	1.41	<b>19.20</b>	<b>1.43</b>	20.96	1.46	22.10	1.49
		100	15.99	1.37	17.13	1.42	18.28	1.47	18.95	1.49	20.56	1.52	21.70	1.55
		105	15.59	1.43	16.74	1.48	17.88	1.53	18.70	1.55	20.16	1.58	21.30	1.61
		110	15.19	1.48	16.34	1.54	17.48	1.60	18.30	1.61	19.76	1.64	20.90	1.68
		115	14.80	1.54	15.94	1.60	17.08	1.66	17.90	1.67	19.36	1.71	20.51	1.74
		118	14.56	1.57	15.70	1.63	16.84	1.69	17.66	1.71	19.12	1.74	20.27	1.78
122	14.48	1.62	15.62	1.68	16.76	1.74	17.58	1.76	19.04	1.79	20.19	1.83		

TC = Total Capacity (kBtu/h).

PI = Power Input (kW).

Nominal capacity as rated: 0 ft. above sea level with 25 ft. of refrigerant piping.  
0 ft. level difference between outdoor and indoor units.

Nominal cooling capacity rating obtained with air entering the indoor unit at 80°F dry bulb (DB) and 67°F wet bulb (WB), and outdoor ambient conditions of 95°F dry bulb (DB) and 75°F wet bulb (WB).

The shaded table rows indicate reference data. When operating at this temperature, these values can be different if the system is not running consistently.



Multi F and Multi F MAX Heat Pump System Engineering Manual

Table 31: LMU247HV Cooling Capacity Table — Non-Ducted Indoor Units (continued).

Connected Indoor Units	Combination Capacity Index	Outdoor Air Temp. (°F DB)	Indoor Air Temp. °F DB / °F WB											
			68 / 57		73 / 61		77 / 64		80 / 67		86 / 72		90 / 75	
			TC	PI	TC	PI	TC	PI	TC	PI	TC	PI	TC	PI
Three (3) Non-Ducted Indoor Units	9 + 9 + 12	14	18.82	0.90	19.99	0.93	21.16	0.96	22.00	0.97	23.50	0.99	24.67	1.01
		20	18.81	0.91	19.98	0.94	21.14	0.98	21.99	0.99	23.48	1.01	24.65	1.03
		25	18.79	0.92	19.96	0.95	21.13	0.99	21.97	1.00	23.46	1.02	24.63	1.04
		30	18.78	0.93	19.94	0.97	21.11	1.00	21.95	1.02	23.44	1.03	24.61	1.05
		35	18.76	0.95	19.93	0.98	21.09	1.02	21.94	1.03	23.43	1.05	24.59	1.07
		40	18.75	0.96	19.91	0.99	21.08	1.03	21.92	1.04	23.41	1.06	24.57	1.08
		45	18.74	0.97	19.90	1.01	21.06	1.05	21.90	1.06	23.39	1.08	24.55	1.10
		50	18.72	0.99	19.88	1.02	21.05	1.06	21.89	1.07	23.37	1.09	24.53	1.11
		55	18.71	1.00	19.87	1.03	21.03	1.07	21.87	1.09	23.35	1.11	24.52	1.13
		60	18.69	1.01	19.85	1.05	21.01	1.09	21.85	1.10	23.34	1.12	24.50	1.14
		65	18.68	1.02	19.84	1.06	21.00	1.10	21.84	1.11	23.32	1.13	24.48	1.16
		70	18.66	1.04	19.82	1.07	20.98	1.11	21.82	1.13	23.30	1.15	24.46	1.17
		75	18.21	1.09	19.37	1.13	20.53	1.17	21.36	1.19	22.84	1.21	24.00	1.23
		80	17.77	1.15	18.92	1.19	20.07	1.23	20.91	1.25	22.38	1.27	23.53	1.30
		85	17.32	1.20	18.47	1.25	19.62	1.29	20.45	1.31	21.92	1.33	23.07	1.36
		90	16.88	1.26	18.02	1.31	19.17	1.35	20.00	1.37	21.47	1.40	22.61	1.42
		95	16.39	1.32	17.53	1.36	18.68	1.41	<b>19.20</b>	<b>1.43</b>	20.96	1.46	22.10	1.49
		100	15.99	1.37	17.13	1.42	18.28	1.47	18.95	1.49	20.56	1.52	21.70	1.55
		105	15.59	1.43	16.74	1.48	17.88	1.53	18.70	1.55	20.16	1.58	21.30	1.61
		110	15.19	1.48	16.34	1.54	17.48	1.60	18.30	1.61	19.76	1.64	20.90	1.68
		115	14.80	1.54	15.94	1.60	17.08	1.66	17.90	1.67	19.36	1.71	20.51	1.74
	118	14.56	1.57	15.70	1.63	16.84	1.69	17.66	1.71	19.12	1.74	20.27	1.78	
	122	14.48	1.62	15.62	1.68	16.76	1.74	17.58	1.76	19.04	1.79	20.19	1.83	
	9 + 12 + 12	14	18.82	0.90	19.99	0.93	21.16	0.96	22.00	0.97	23.50	0.99	24.67	1.01
		20	18.81	0.91	19.98	0.94	21.14	0.98	21.99	0.99	23.48	1.01	24.65	1.03
		25	18.79	0.92	19.96	0.95	21.13	0.99	21.97	1.00	23.46	1.02	24.63	1.04
		30	18.78	0.93	19.94	0.97	21.11	1.00	21.95	1.02	23.44	1.03	24.61	1.05
		35	18.76	0.95	19.93	0.98	21.09	1.02	21.94	1.03	23.43	1.05	24.59	1.07
		40	18.75	0.96	19.91	0.99	21.08	1.03	21.92	1.04	23.41	1.06	24.57	1.08
		45	18.74	0.97	19.90	1.01	21.06	1.05	21.90	1.06	23.39	1.08	24.55	1.10
		50	18.72	0.99	19.88	1.02	21.05	1.06	21.89	1.07	23.37	1.09	24.53	1.11
		55	18.71	1.00	19.87	1.03	21.03	1.07	21.87	1.09	23.35	1.11	24.52	1.13
		60	18.69	1.01	19.85	1.05	21.01	1.09	21.85	1.10	23.34	1.12	24.50	1.14
		65	18.68	1.02	19.84	1.06	21.00	1.10	21.84	1.11	23.32	1.13	24.48	1.16
		70	18.66	1.04	19.82	1.07	20.98	1.11	21.82	1.13	23.30	1.15	24.46	1.17
		75	18.21	1.09	19.37	1.13	20.53	1.17	21.36	1.19	22.84	1.21	24.00	1.23
		80	17.77	1.15	18.92	1.19	20.07	1.23	20.91	1.25	22.38	1.27	23.53	1.30
		85	17.32	1.20	18.47	1.25	19.62	1.29	20.45	1.31	21.92	1.33	23.07	1.36
		90	16.88	1.26	18.02	1.31	19.17	1.35	20.00	1.37	21.47	1.40	22.61	1.42
		95	16.39	1.32	17.53	1.36	18.68	1.41	<b>19.20</b>	<b>1.43</b>	20.96	1.46	22.10	1.49
		100	15.99	1.37	17.13	1.42	18.28	1.47	18.95	1.49	20.56	1.52	21.70	1.55
		105	15.59	1.43	16.74	1.48	17.88	1.53	18.70	1.55	20.16	1.58	21.30	1.61
110		15.19	1.48	16.34	1.54	17.48	1.60	18.30	1.61	19.76	1.64	20.90	1.68	
115		14.80	1.54	15.94	1.60	17.08	1.66	17.90	1.67	19.36	1.71	20.51	1.74	
118	14.56	1.57	15.70	1.63	16.84	1.69	17.66	1.71	19.12	1.74	20.27	1.78		
122	14.48	1.62	15.62	1.68	16.76	1.74	17.58	1.76	19.04	1.79	20.19	1.83		

TC = Total Capacity (kBtu/h).

PI = Power Input (kW).

Nominal capacity as rated: 0 ft. above sea level with 25 ft. of refrigerant piping.  
0 ft. level difference between outdoor and indoor units.

Nominal cooling capacity rating obtained with air entering the indoor unit at 80°F dry bulb (DB) and 67°F wet bulb (WB), and outdoor ambient conditions of 95°F dry bulb (DB) and 75°F wet bulb (WB).

The shaded table rows indicate reference data. When operating at this temperature, these values can be different if the system is not running consistently.

# PERFORMANCE DATA

## Cooling Capacity Tables

MULTI F  
MULTI F MAX

Table 32: LMU247HV Cooling Capacity Table — Ducted Indoor Units.

Connected Indoor Units	Combination Capacity Index	Outdoor Air Temp. (°F DB)	Indoor Air Temp. °F DB / °F WB											
			68 / 57		73 / 61		77 / 64		80 / 67		86 / 72		90 / 75	
			TC	PI	TC	PI	TC	PI	TC	PI	TC	PI	TC	PI
Two (2) Ducted Indoor Units	9 + 9	14	16.27	0.94	17.28	0.97	18.29	1.01	19.02	1.02	20.32	1.04	21.33	1.06
		20	16.26	0.95	17.27	0.98	18.28	1.02	19.01	1.03	20.30	1.05	21.31	1.07
		25	16.25	0.96	17.26	1.00	18.27	1.03	19.00	1.05	20.28	1.07	21.29	1.09
		30	16.24	0.98	17.24	1.01	18.25	1.05	18.98	1.06	20.27	1.08	21.28	1.10
		35	16.22	0.99	17.23	1.03	18.24	1.06	18.97	1.08	20.25	1.10	21.26	1.12
		40	16.21	1.00	17.22	1.04	18.22	1.08	18.95	1.09	20.24	1.11	21.24	1.13
		45	16.20	1.02	17.20	1.05	18.21	1.09	18.94	1.10	20.22	1.13	21.23	1.15
		50	16.19	1.03	17.19	1.07	18.20	1.11	18.92	1.12	20.21	1.14	21.21	1.16
		55	16.17	1.04	17.18	1.08	18.18	1.12	18.91	1.13	20.19	1.15	21.20	1.18
		60	16.16	1.06	17.16	1.10	18.17	1.14	18.89	1.15	20.18	1.17	21.18	1.19
		65	16.15	1.07	17.15	1.11	18.15	1.15	18.88	1.16	20.16	1.18	21.16	1.21
		70	16.14	1.08	17.14	1.12	18.14	1.16	18.86	1.18	20.14	1.20	21.15	1.22
		75	15.75	1.14	16.75	1.18	17.75	1.23	18.47	1.24	19.75	1.26	20.75	1.29
		80	15.36	1.20	16.36	1.24	17.35	1.29	18.07	1.30	19.35	1.33	20.35	1.36
		85	14.97	1.26	15.97	1.30	16.96	1.35	17.68	1.37	18.95	1.39	19.95	1.42
		90	14.59	1.32	15.58	1.37	16.57	1.42	17.29	1.43	18.56	1.46	19.55	1.49
		95	14.17	1.38	15.16	1.43	16.15	1.48	16.60	1.50	18.12	1.52	19.11	1.55
		100	13.83	1.43	14.81	1.49	15.80	1.54	16.38	1.56	17.78	1.59	18.76	1.62
		105	13.48	1.49	14.47	1.55	15.46	1.60	16.17	1.62	17.43	1.65	18.42	1.69
		110	13.14	1.55	14.12	1.61	15.11	1.67	15.82	1.69	17.09	1.72	18.07	1.75
		115	12.79	1.61	13.78	1.67	14.77	1.73	15.48	1.75	16.74	1.78	17.73	1.82
	118	12.58	1.64	13.57	1.70	14.56	1.77	15.27	1.79	16.53	1.82	17.52	1.86	
	122	12.52	1.69	13.50	1.75	14.49	1.82	15.20	1.84	16.47	1.87	17.45	1.91	
	14	16.67	0.94	17.70	0.98	18.74	1.01	19.48	1.02	20.80	1.04	21.84	1.06	
	20	16.65	0.95	17.69	0.99	18.72	1.03	19.47	1.04	20.79	1.06	21.82	1.08	
	25	16.64	0.97	17.67	1.00	18.71	1.04	19.45	1.05	20.77	1.07	21.81	1.09	
	30	16.63	0.98	17.66	1.02	18.69	1.05	19.44	1.07	20.76	1.09	21.79	1.11	
	35	16.61	1.00	17.65	1.03	18.68	1.07	19.42	1.08	20.74	1.10	21.77	1.12	
	40	16.60	1.01	17.63	1.05	18.66	1.08	19.41	1.10	20.73	1.12	21.76	1.14	
	45	16.59	1.02	17.62	1.06	18.65	1.10	19.39	1.11	20.71	1.13	21.74	1.15	
	50	16.58	1.04	17.61	1.07	18.63	1.11	19.38	1.13	20.69	1.15	21.72	1.17	
	55	16.56	1.05	17.59	1.09	18.62	1.13	19.36	1.14	20.68	1.16	21.71	1.19	
	60	16.55	1.06	17.58	1.10	18.61	1.14	19.35	1.16	20.66	1.18	21.69	1.20	
	65	16.54	1.08	17.57	1.12	18.59	1.16	19.33	1.17	20.65	1.19	21.67	1.22	
	70	16.53	1.09	17.55	1.13	18.58	1.17	19.32	1.18	20.63	1.21	21.66	1.23	
	75	16.13	1.15	17.15	1.19	18.18	1.23	18.91	1.25	20.22	1.27	21.25	1.30	
	80	15.73	1.21	16.75	1.25	17.77	1.30	18.51	1.31	19.81	1.34	20.84	1.36	
	85	15.34	1.27	16.35	1.31	17.37	1.36	18.11	1.38	19.41	1.40	20.43	1.43	
	90	14.94	1.33	15.96	1.37	16.97	1.42	17.71	1.44	19.01	1.47	20.02	1.50	
	95	14.51	1.38	15.52	1.43	16.54	1.49	17.00	1.50	18.56	1.53	19.57	1.56	
	100	14.16	1.44	15.17	1.50	16.18	1.55	16.78	1.57	18.20	1.60	19.22	1.63	
	105	13.81	1.50	14.82	1.56	15.83	1.61	16.56	1.63	17.85	1.66	18.86	1.70	
110	13.45	1.56	14.46	1.62	15.48	1.68	16.21	1.70	17.50	1.73	18.51	1.76		
115	13.10	1.62	14.11	1.68	15.12	1.74	15.85	1.76	17.14	1.79	18.16	1.83		
118	12.89	1.65	13.90	1.71	14.91	1.78	15.64	1.80	16.93	1.83	17.94	1.87		
122	12.82	1.70	13.83	1.76	14.84	1.83	15.57	1.85	16.86	1.88	17.87	1.92		

TC = Total Capacity (kBtu/h).

PI = Power Input (kW).

Nominal capacity as rated: 0 ft. above sea level with 25 ft. of refrigerant piping.  
0 ft. level difference between outdoor and indoor units.

Nominal cooling capacity rating obtained with air entering the indoor unit at 80°F dry bulb (DB) and 67°F wet bulb (WB), and outdoor ambient conditions of 95°F dry bulb (DB) and 75°F wet bulb (WB).

The shaded table rows indicate reference data. When operating at this temperature, these values can be different if the system is not running consistently.



Multi F and Multi F MAX Heat Pump System Engineering Manual

Table 33: LMU247HV Cooling Capacity Table — Ducted Indoor Units (continued).

Connected Indoor Units	Combination Capacity Index	Outdoor Air Temp. (°F DB)	Indoor Air Temp. °F DB / °F WB											
			68 / 57		73 / 61		77 / 64		80 / 67		86 / 72		90 / 75	
			TC	PI	TC	PI	TC	PI	TC	PI	TC	PI	TC	PI
Two (2) Ducted Indoor Units	12 + 12	14	17.65	0.98	18.74	1.02	19.84	1.05	20.63	1.06	22.03	1.08	23.12	1.11
		20	17.63	0.99	18.73	1.03	19.82	1.07	20.61	1.08	22.01	1.10	23.11	1.12
		25	17.62	1.01	18.71	1.04	19.81	1.08	20.60	1.09	22.00	1.12	23.09	1.14
		30	17.60	1.02	18.70	1.06	19.79	1.10	20.58	1.11	21.98	1.13	23.07	1.15
		35	17.59	1.04	18.68	1.07	19.78	1.11	20.57	1.13	21.96	1.15	23.05	1.17
		40	17.58	1.05	18.67	1.09	19.76	1.13	20.55	1.14	21.94	1.16	23.04	1.19
		45	17.56	1.06	18.66	1.10	19.75	1.14	20.53	1.16	21.93	1.18	23.02	1.20
		50	17.55	1.08	18.64	1.12	19.73	1.16	20.52	1.17	21.91	1.19	23.00	1.22
		55	17.54	1.09	18.63	1.13	19.72	1.17	20.50	1.19	21.89	1.21	22.98	1.23
		60	17.52	1.11	18.61	1.15	19.70	1.19	20.49	1.20	21.88	1.22	22.97	1.25
		65	17.51	1.12	18.60	1.16	19.69	1.20	20.47	1.22	21.86	1.24	22.95	1.26
		70	17.50	1.13	18.58	1.18	19.67	1.22	20.46	1.23	21.84	1.26	22.93	1.28
		75	17.08	1.20	18.16	1.24	19.24	1.28	20.03	1.30	21.41	1.32	22.50	1.35
		80	16.66	1.26	17.74	1.30	18.82	1.35	19.60	1.37	20.98	1.39	22.06	1.42
		85	16.24	1.32	17.32	1.37	18.40	1.42	19.17	1.43	20.55	1.46	21.63	1.49
		90	15.82	1.38	16.90	1.43	17.97	1.48	18.75	1.50	20.12	1.53	21.20	1.56
		95	15.37	1.44	16.44	1.49	17.51	1.55	<b>18.00</b>	<b>1.57</b>	19.65	1.59	20.72	1.63
		100	14.99	1.50	16.06	1.56	17.13	1.61	17.77	1.63	19.28	1.66	20.35	1.70
		105	14.62	1.56	15.69	1.62	16.76	1.68	17.53	1.70	18.90	1.73	19.97	1.76
		110	14.24	1.62	15.32	1.68	16.39	1.74	17.16	1.76	18.53	1.80	19.60	1.83
		115	13.87	1.68	14.94	1.75	16.01	1.81	16.79	1.83	18.15	1.87	19.22	1.90
		118	13.65	1.72	14.72	1.78	15.79	1.85	16.56	1.87	17.93	1.91	19.00	1.94
	122	13.57	1.77	14.64	1.84	15.71	1.90	16.49	1.92	17.85	1.96	18.92	2.00	
	9 + 18	14	17.65	0.98	18.74	1.02	19.84	1.05	20.63	1.06	22.03	1.08	23.12	1.11
		20	17.63	0.99	18.73	1.03	19.82	1.07	20.61	1.08	22.01	1.10	23.11	1.12
		25	17.62	1.01	18.71	1.04	19.81	1.08	20.60	1.09	22.00	1.12	23.09	1.14
		30	17.60	1.02	18.70	1.06	19.79	1.10	20.58	1.11	21.98	1.13	23.07	1.15
		35	17.59	1.04	18.68	1.07	19.78	1.11	20.57	1.13	21.96	1.15	23.05	1.17
		40	17.58	1.05	18.67	1.09	19.76	1.13	20.55	1.14	21.94	1.16	23.04	1.19
		45	17.56	1.06	18.66	1.10	19.75	1.14	20.53	1.16	21.93	1.18	23.02	1.20
		50	17.55	1.08	18.64	1.12	19.73	1.16	20.52	1.17	21.91	1.19	23.00	1.22
		55	17.54	1.09	18.63	1.13	19.72	1.17	20.50	1.19	21.89	1.21	22.98	1.23
		60	17.52	1.11	18.61	1.15	19.70	1.19	20.49	1.20	21.88	1.22	22.97	1.25
		65	17.51	1.12	18.60	1.16	19.69	1.20	20.47	1.22	21.86	1.24	22.95	1.26
		70	17.50	1.13	18.58	1.18	19.67	1.22	20.46	1.23	21.84	1.26	22.93	1.28
		75	17.08	1.20	18.16	1.24	19.24	1.28	20.03	1.30	21.41	1.32	22.50	1.35
		80	16.66	1.26	17.74	1.30	18.82	1.35	19.60	1.37	20.98	1.39	22.06	1.42
		85	16.24	1.32	17.32	1.37	18.40	1.42	19.17	1.43	20.55	1.46	21.63	1.49
		90	15.82	1.38	16.90	1.43	17.97	1.48	18.75	1.50	20.12	1.53	21.20	1.56
		95	15.37	1.44	16.44	1.49	17.51	1.55	<b>18.00</b>	<b>1.57</b>	19.65	1.59	20.72	1.63
		100	14.99	1.50	16.06	1.56	17.13	1.61	17.77	1.63	19.28	1.66	20.35	1.70
		105	14.62	1.56	15.69	1.62	16.76	1.68	17.53	1.70	18.90	1.73	19.97	1.76
110		14.24	1.62	15.32	1.68	16.39	1.74	17.16	1.76	18.53	1.80	19.60	1.83	
115		13.87	1.68	14.94	1.75	16.01	1.81	16.79	1.83	18.15	1.87	19.22	1.90	
118		13.65	1.72	14.72	1.78	15.79	1.85	16.56	1.87	17.93	1.91	19.00	1.94	
122	13.57	1.77	14.64	1.84	15.71	1.90	16.49	1.92	17.85	1.96	18.92	2.00		

TC = Total Capacity (kBtu/h).

PI = Power Input (kW).

Nominal capacity as rated: 0 ft. above sea level with 25 ft. of refrigerant piping.  
0 ft. level difference between outdoor and indoor units.

Nominal cooling capacity rating obtained with air entering the indoor unit at 80°F dry bulb (DB) and 67°F wet bulb (WB), and outdoor ambient conditions of 95°F dry bulb (DB) and 75°F wet bulb (WB).

The shaded table rows indicate reference data. When operating at this temperature, these values can be different if the system is not running consistently.

# PERFORMANCE DATA

## Cooling Capacity Tables

MULTI F  
MULTI F MAX

Table 34: LMU247HV Cooling Capacity Table — Ducted Indoor Units (continued).

Connected Indoor Units	Combination Capacity Index	Outdoor Air Temp. (°F DB)	Indoor Air Temp. °F DB / °F WB											
			68 / 57		73 / 61		77 / 64		80 / 67		86 / 72		90 / 75	
			TC	PI	TC	PI	TC	PI	TC	PI	TC	PI	TC	PI
Two (2) Ducted Indoor Units	12 + 18	14	17.65	0.98	18.74	1.02	19.84	1.05	20.63	1.06	22.03	1.08	23.12	1.11
		20	17.63	0.99	18.73	1.03	19.82	1.07	20.61	1.08	22.01	1.10	23.11	1.12
		25	17.62	1.01	18.71	1.04	19.81	1.08	20.60	1.09	22.00	1.12	23.09	1.14
		30	17.60	1.02	18.70	1.06	19.79	1.10	20.58	1.11	21.98	1.13	23.07	1.15
		35	17.59	1.04	18.68	1.07	19.78	1.11	20.57	1.13	21.96	1.15	23.05	1.17
		40	17.58	1.05	18.67	1.09	19.76	1.13	20.55	1.14	21.94	1.16	23.04	1.19
		45	17.56	1.06	18.66	1.10	19.75	1.14	20.53	1.16	21.93	1.18	23.02	1.20
		50	17.55	1.08	18.64	1.12	19.73	1.16	20.52	1.17	21.91	1.19	23.00	1.22
		55	17.54	1.09	18.63	1.13	19.72	1.17	20.50	1.19	21.89	1.21	22.98	1.23
		60	17.52	1.11	18.61	1.15	19.70	1.19	20.49	1.20	21.88	1.22	22.97	1.25
		65	17.51	1.12	18.60	1.16	19.69	1.20	20.47	1.22	21.86	1.24	22.95	1.26
		70	17.50	1.13	18.58	1.18	19.67	1.22	20.46	1.23	21.84	1.26	22.93	1.28
		75	17.08	1.20	18.16	1.24	19.24	1.28	20.03	1.30	21.41	1.32	22.50	1.35
		80	16.66	1.26	17.74	1.30	18.82	1.35	19.60	1.37	20.98	1.39	22.06	1.42
		85	16.24	1.32	17.32	1.37	18.40	1.42	19.17	1.43	20.55	1.46	21.63	1.49
		90	15.82	1.38	16.90	1.43	17.97	1.48	18.75	1.50	20.12	1.53	21.20	1.56
		95	15.37	1.44	16.44	1.49	17.51	1.55	<b>18.00</b>	<b>1.57</b>	19.65	1.59	20.72	1.63
		100	14.99	1.50	16.06	1.56	17.13	1.61	17.77	1.63	19.28	1.66	20.35	1.70
		105	14.62	1.56	15.69	1.62	16.76	1.68	17.53	1.70	18.90	1.73	19.97	1.76
		110	14.24	1.62	15.32	1.68	16.39	1.74	17.16	1.76	18.53	1.80	19.60	1.83
115	13.87	1.68	14.94	1.75	16.01	1.81	16.79	1.83	18.15	1.87	19.22	1.90		
118	13.65	1.72	14.72	1.78	15.79	1.85	16.56	1.87	17.93	1.91	19.00	1.94		
122	13.57	1.77	14.64	1.84	15.71	1.90	16.49	1.92	17.85	1.96	18.92	2.00		
Three (3) Ducted Indoor Units	9 + 9 + 9	14	17.65	0.95	18.74	0.99	19.84	1.03	20.63	1.04	22.03	1.06	23.12	1.08
		20	17.63	0.97	18.73	1.00	19.82	1.04	20.61	1.05	22.01	1.07	23.11	1.09
		25	17.62	0.98	18.71	1.02	19.81	1.05	20.60	1.07	22.00	1.09	23.09	1.11
		30	17.60	1.00	18.70	1.03	19.79	1.07	20.58	1.08	21.98	1.10	23.07	1.12
		35	17.59	1.01	18.68	1.05	19.78	1.08	20.57	1.10	21.96	1.12	23.05	1.14
		40	17.58	1.02	18.67	1.06	19.76	1.10	20.55	1.11	21.94	1.13	23.04	1.16
		45	17.56	1.04	18.66	1.07	19.75	1.11	20.53	1.13	21.93	1.15	23.02	1.17
		50	17.55	1.05	18.64	1.09	19.73	1.13	20.52	1.14	21.91	1.16	23.00	1.19
		55	17.54	1.06	18.63	1.10	19.72	1.14	20.50	1.16	21.89	1.18	22.98	1.20
		60	17.52	1.08	18.61	1.12	19.70	1.16	20.49	1.17	21.88	1.19	22.97	1.22
		65	17.51	1.09	18.60	1.13	19.69	1.17	20.47	1.19	21.86	1.21	22.95	1.23
		70	17.50	1.11	18.58	1.15	19.67	1.19	20.46	1.20	21.84	1.22	22.93	1.25
		75	17.08	1.16	18.16	1.21	19.24	1.25	20.03	1.27	21.41	1.29	22.50	1.32
		80	16.66	1.22	17.74	1.27	18.82	1.32	19.60	1.33	20.98	1.36	22.06	1.38
		85	16.24	1.28	17.32	1.33	18.40	1.38	19.17	1.40	20.55	1.42	21.63	1.45
		90	15.82	1.34	16.90	1.39	17.97	1.44	18.75	1.46	20.12	1.49	21.20	1.52
		95	15.37	1.40	16.44	1.45	17.51	1.51	<b>18.00</b>	<b>1.53</b>	19.65	1.55	20.72	1.58
		100	14.99	1.46	16.06	1.52	17.13	1.57	17.77	1.59	19.28	1.62	20.35	1.65
		105	14.62	1.52	15.69	1.58	16.76	1.64	17.53	1.65	18.90	1.69	19.97	1.72
		110	14.24	1.58	15.32	1.64	16.39	1.70	17.16	1.72	18.53	1.75	19.60	1.79
115	13.87	1.64	14.94	1.70	16.01	1.76	16.79	1.78	18.15	1.82	19.22	1.85		
118	13.65	1.68	14.72	1.74	15.79	1.80	16.56	1.82	17.93	1.86	19.00	1.89		
122	13.57	1.73	14.64	1.79	15.71	1.85	16.49	1.87	17.85	1.91	18.92	1.95		

TC = Total Capacity (kBtu/h).

PI = Power Input (kW).

Nominal capacity as rated: 0 ft. above sea level with 25 ft. of refrigerant piping.  
0 ft. level difference between outdoor and indoor units.

Nominal cooling capacity rating obtained with air entering the indoor unit at 80°F dry bulb (DB) and 67°F wet bulb (WB), and outdoor ambient conditions of 95°F dry bulb (DB) and 75°F wet bulb (WB).

The shaded table rows indicate reference data. When operating at this temperature, these values can be different if the system is not running consistently.



Multi F and Multi F MAX Heat Pump System Engineering Manual

Table 35: LMU247HV Cooling Capacity Table — Ducted Indoor Units (continued).

Connected Indoor Units	Combination Capacity Index	Outdoor Air Temp. (°F DB)	Indoor Air Temp. °F DB / °F WB											
			68 / 57		73 / 61		77 / 64		80 / 67		86 / 72		90 / 75	
			TC	PI	TC	PI	TC	PI	TC	PI	TC	PI	TC	PI
Three (3) Ducted Indoor Units	9 + 9 + 12	14	17.65	0.95	18.74	0.99	19.84	1.03	20.63	1.04	22.03	1.06	23.12	1.08
		20	17.63	0.97	18.73	1.00	19.82	1.04	20.61	1.05	22.01	1.07	23.11	1.09
		25	17.62	0.98	18.71	1.02	19.81	1.05	20.60	1.07	22.00	1.09	23.09	1.11
		30	17.60	1.00	18.70	1.03	19.79	1.07	20.58	1.08	21.98	1.10	23.07	1.12
		35	17.59	1.01	18.68	1.05	19.78	1.08	20.57	1.10	21.96	1.12	23.05	1.14
		40	17.58	1.02	18.67	1.06	19.76	1.10	20.55	1.11	21.94	1.13	23.04	1.16
		45	17.56	1.04	18.66	1.07	19.75	1.11	20.53	1.13	21.93	1.15	23.02	1.17
		50	17.55	1.05	18.64	1.09	19.73	1.13	20.52	1.14	21.91	1.16	23.00	1.19
		55	17.54	1.06	18.63	1.10	19.72	1.14	20.50	1.16	21.89	1.18	22.98	1.20
		60	17.52	1.08	18.61	1.12	19.70	1.16	20.49	1.17	21.88	1.19	22.97	1.22
		65	17.51	1.09	18.60	1.13	19.69	1.17	20.47	1.19	21.86	1.21	22.95	1.23
		70	17.50	1.11	18.58	1.15	19.67	1.19	20.46	1.20	21.84	1.22	22.93	1.25
		75	17.08	1.16	18.16	1.21	19.24	1.25	20.03	1.27	21.41	1.29	22.50	1.32
		80	16.66	1.22	17.74	1.27	18.82	1.32	19.60	1.33	20.98	1.36	22.06	1.38
		85	16.24	1.28	17.32	1.33	18.40	1.38	19.17	1.40	20.55	1.42	21.63	1.45
		90	15.82	1.34	16.90	1.39	17.97	1.44	18.75	1.46	20.12	1.49	21.20	1.52
		95	15.37	1.40	16.44	1.45	17.51	1.51	<b>18.00</b>	<b>1.53</b>	19.65	1.55	20.72	1.58
		100	14.99	1.46	16.06	1.52	17.13	1.57	17.77	1.59	19.28	1.62	20.35	1.65
	105	14.62	1.52	15.69	1.58	16.76	1.64	17.53	1.65	18.90	1.69	19.97	1.72	
	110	14.24	1.58	15.32	1.64	16.39	1.70	17.16	1.72	18.53	1.75	19.60	1.79	
	115	13.87	1.64	14.94	1.70	16.01	1.76	16.79	1.78	18.15	1.82	19.22	1.85	
	118	13.65	1.68	14.72	1.74	15.79	1.80	16.56	1.82	17.93	1.86	19.00	1.89	
	122	13.57	1.73	14.64	1.79	15.71	1.85	16.49	1.87	17.85	1.91	18.92	1.95	
	9 + 12 + 12	14	17.65	0.95	18.74	0.99	19.84	1.03	20.63	1.04	22.03	1.06	23.12	1.08
		20	17.63	0.97	18.73	1.00	19.82	1.04	20.61	1.05	22.01	1.07	23.11	1.09
		25	17.62	0.98	18.71	1.02	19.81	1.05	20.60	1.07	22.00	1.09	23.09	1.11
		30	17.60	1.00	18.70	1.03	19.79	1.07	20.58	1.08	21.98	1.10	23.07	1.12
		35	17.59	1.01	18.68	1.05	19.78	1.08	20.57	1.10	21.96	1.12	23.05	1.14
		40	17.58	1.02	18.67	1.06	19.76	1.10	20.55	1.11	21.94	1.13	23.04	1.16
		45	17.56	1.04	18.66	1.07	19.75	1.11	20.53	1.13	21.93	1.15	23.02	1.17
		50	17.55	1.05	18.64	1.09	19.73	1.13	20.52	1.14	21.91	1.16	23.00	1.19
		55	17.54	1.06	18.63	1.10	19.72	1.14	20.50	1.16	21.89	1.18	22.98	1.20
		60	17.52	1.08	18.61	1.12	19.70	1.16	20.49	1.17	21.88	1.19	22.97	1.22
		65	17.51	1.09	18.60	1.13	19.69	1.17	20.47	1.19	21.86	1.21	22.95	1.23
		70	17.50	1.11	18.58	1.15	19.67	1.19	20.46	1.20	21.84	1.22	22.93	1.25
		75	17.08	1.16	18.16	1.21	19.24	1.25	20.03	1.27	21.41	1.29	22.50	1.32
		80	16.66	1.22	17.74	1.27	18.82	1.32	19.60	1.33	20.98	1.36	22.06	1.38
		85	16.24	1.28	17.32	1.33	18.40	1.38	19.17	1.40	20.55	1.42	21.63	1.45
		90	15.82	1.34	16.90	1.39	17.97	1.44	18.75	1.46	20.12	1.49	21.20	1.52
		95	15.37	1.40	16.44	1.45	17.51	1.51	<b>18.00</b>	<b>1.53</b>	19.65	1.55	20.72	1.58
		100	14.99	1.46	16.06	1.52	17.13	1.57	17.77	1.59	19.28	1.62	20.35	1.65
	105	14.62	1.52	15.69	1.58	16.76	1.64	17.53	1.65	18.90	1.69	19.97	1.72	
110	14.24	1.58	15.32	1.64	16.39	1.70	17.16	1.72	18.53	1.75	19.60	1.79		
115	13.87	1.64	14.94	1.70	16.01	1.76	16.79	1.78	18.15	1.82	19.22	1.85		
118	13.65	1.68	14.72	1.74	15.79	1.80	16.56	1.82	17.93	1.86	19.00	1.89		
122	13.57	1.73	14.64	1.79	15.71	1.85	16.49	1.87	17.85	1.91	18.92	1.95		

TC = Total Capacity (kBtu/h).

PI = Power Input (kW).

Nominal capacity as rated: 0 ft. above sea level with 25 ft. of refrigerant piping.  
0 ft. level difference between outdoor and indoor units.

Nominal cooling capacity rating obtained with air entering the indoor unit at 80°F dry bulb (DB) and 67°F wet bulb (WB), and outdoor ambient conditions of 95°F dry bulb (DB) and 75°F wet bulb (WB).

The shaded table rows indicate reference data. When operating at this temperature, these values can be different if the system is not running consistently.

# PERFORMANCE DATA

## Cooling Capacity Tables

MULTI F  
MULTI F MAX

Table 36: LMU247HV Cooling Capacity Table — Mixed Indoor Units.

Connected Indoor Units	Combination Capacity Index	Outdoor Air Temp. (°F DB)	Indoor Air Temp. °F DB / °F WB											
			68 / 57		73 / 61		77 / 64		80 / 67		86 / 72		90 / 75	
			TC	PI	TC	PI	TC	PI	TC	PI	TC	PI	TC	PI
Two (2) Mixed Indoor Units	9 + 9	14	16.47	0.89	17.49	0.92	18.51	0.96	19.25	0.97	20.56	0.99	21.58	1.00
		20	16.46	0.90	17.48	0.94	18.50	0.97	19.24	0.98	20.54	1.00	21.57	1.02
		25	16.44	0.92	17.47	0.95	18.49	0.98	19.22	0.99	20.53	1.01	21.55	1.03
		30	16.43	0.93	17.45	0.96	18.47	1.00	19.21	1.01	20.51	1.03	21.53	1.05
		35	16.42	0.94	17.44	0.98	18.46	1.01	19.19	1.02	20.50	1.04	21.52	1.06
		40	16.41	0.95	17.43	0.99	18.44	1.02	19.18	1.04	20.48	1.06	21.50	1.08
		45	16.39	0.97	17.41	1.00	18.43	1.04	19.17	1.05	20.47	1.07	21.48	1.09
		50	16.38	0.98	17.40	1.02	18.42	1.05	19.15	1.06	20.45	1.08	21.47	1.11
		55	16.37	0.99	17.39	1.03	18.40	1.07	19.14	1.08	20.43	1.10	21.45	1.12
		60	16.36	1.00	17.37	1.04	18.39	1.08	19.12	1.09	20.42	1.11	21.43	1.13
		65	16.34	1.02	17.36	1.05	18.37	1.09	19.11	1.11	20.40	1.13	21.42	1.15
		70	16.33	1.03	17.35	1.07	18.36	1.11	19.09	1.12	20.39	1.14	21.40	1.16
		75	15.94	1.09	16.95	1.13	17.96	1.17	18.69	1.18	19.98	1.20	21.00	1.23
		80	15.54	1.14	16.55	1.18	17.56	1.23	18.29	1.24	19.58	1.26	20.59	1.29
		85	15.16	1.20	16.16	1.24	17.17	1.29	17.90	1.30	19.18	1.33	20.19	1.35
		90	14.77	1.25	15.77	1.30	16.77	1.35	17.50	1.36	18.78	1.39	19.79	1.41
		95	14.34	1.31	15.34	1.36	16.34	1.41	<b>16.80</b>	<b>1.42</b>	18.34	1.45	19.34	1.48
		100	13.99	1.36	14.99	1.41	15.99	1.47	16.58	1.48	17.99	1.51	18.99	1.54
		105	13.64	1.42	14.64	1.47	15.64	1.53	16.36	1.54	17.64	1.57	18.64	1.60
		110	13.30	1.48	14.29	1.53	15.29	1.58	16.02	1.60	17.29	1.63	18.29	1.67
		115	12.95	1.53	13.95	1.59	14.94	1.64	15.67	1.66	16.94	1.69	17.94	1.73
	118	12.74	1.56	13.74	1.62	14.73	1.68	15.46	1.70	16.73	1.73	17.73	1.77	
	122	12.67	1.61	13.67	1.67	14.67	1.73	15.39	1.75	16.66	1.78	17.66	1.82	
	14	17.01	0.90	18.06	0.94	19.12	0.97	19.88	0.98	21.23	1.00	22.29	1.02	
	20	17.00	0.92	18.05	0.95	19.11	0.98	19.87	1.00	21.22	1.01	22.27	1.04	
	25	16.98	0.93	18.04	0.96	19.09	1.00	19.85	1.01	21.20	1.03	22.26	1.05	
	30	16.97	0.94	18.02	0.98	19.08	1.01	19.84	1.02	21.18	1.04	22.24	1.06	
	35	16.96	0.96	18.01	0.99	19.06	1.03	19.82	1.04	21.17	1.06	22.22	1.08	
	40	16.94	0.97	18.00	1.00	19.05	1.04	19.81	1.05	21.15	1.07	22.20	1.09	
	45	16.93	0.98	17.98	1.02	19.03	1.05	19.79	1.07	21.14	1.09	22.19	1.11	
	50	16.92	0.99	17.97	1.03	19.02	1.07	19.78	1.08	21.12	1.10	22.17	1.12	
	55	16.90	1.01	17.95	1.04	19.00	1.08	19.76	1.09	21.10	1.12	22.15	1.14	
	60	16.89	1.02	17.94	1.06	18.99	1.10	19.75	1.11	21.09	1.13	22.14	1.15	
	65	16.88	1.03	17.93	1.07	18.97	1.11	19.73	1.12	21.07	1.14	22.12	1.17	
	70	16.87	1.05	17.91	1.08	18.96	1.12	19.72	1.14	21.06	1.16	22.10	1.18	
	75	16.46	1.10	17.50	1.14	18.55	1.18	19.30	1.20	20.64	1.22	21.68	1.25	
	80	16.05	1.16	17.10	1.20	18.14	1.25	18.89	1.26	20.22	1.28	21.27	1.31	
	85	15.65	1.22	16.69	1.26	17.73	1.31	18.48	1.32	19.81	1.35	20.85	1.37	
	90	15.25	1.27	16.29	1.32	17.32	1.37	18.07	1.38	19.40	1.41	20.43	1.44	
	95	14.81	1.33	15.84	1.38	16.88	1.43	<b>17.35</b>	<b>1.44</b>	18.94	1.47	19.97	1.50	
	100	14.45	1.39	15.48	1.44	16.52	1.49	17.13	1.51	18.58	1.53	19.61	1.56	
	105	14.09	1.44	15.12	1.49	16.16	1.55	16.90	1.57	18.22	1.60	19.25	1.63	
110	13.73	1.50	14.76	1.55	15.79	1.61	16.54	1.63	17.86	1.66	18.89	1.69		
115	13.37	1.55	14.40	1.61	15.43	1.67	16.18	1.69	17.50	1.72	18.53	1.76		
118	13.15	1.59	14.19	1.65	15.22	1.71	15.96	1.73	17.28	1.76	18.31	1.79		
122	13.08	1.63	14.11	1.69	15.15	1.76	15.89	1.78	17.21	1.81	18.24	1.84		

TC = Total Capacity (kBtu/h).

PI = Power Input (kW).

Nominal capacity as rated: 0 ft. above sea level with 25 ft. of refrigerant piping.  
0 ft. level difference between outdoor and indoor units.

Nominal cooling capacity rating obtained with air entering the indoor unit at 80°F dry bulb (DB) and 67°F wet bulb (WB), and outdoor ambient conditions of 95°F dry bulb (DB) and 75°F wet bulb (WB).

The shaded rows indicate reference data. When operating at this temperature, these values can be different if the system is not running consistently.

Multi F and Multi F MAX Heat Pump System Engineering Manual

Table 37: LMU247HV Cooling Capacity Table — Mixed Indoor Units.

Connected Indoor Units	Combination Capacity Index	Outdoor Air Temp. (°F DB)	Indoor Air Temp. °F DB / °F WB											
			68 / 57		73 / 61		77 / 64		80 / 67		86 / 72		90 / 75	
			TC	PI	TC	PI	TC	PI	TC	PI	TC	PI	TC	PI
Two (2) Mixed Indoor Units	12 + 12	14	18.23	0.95	19.37	0.98	20.50	1.02	21.32	1.03	22.76	1.05	23.90	1.07
		20	18.22	0.96	19.35	1.00	20.48	1.03	21.30	1.05	22.75	1.07	23.88	1.09
		25	18.21	0.98	19.34	1.01	20.47	1.05	21.28	1.06	22.73	1.08	23.86	1.10
		30	18.19	0.99	19.32	1.03	20.45	1.06	21.27	1.08	22.71	1.10	23.84	1.12
		35	18.18	1.00	19.31	1.04	20.44	1.08	21.25	1.09	22.69	1.11	23.82	1.13
		40	18.16	1.02	19.29	1.05	20.42	1.09	21.23	1.11	22.68	1.13	23.80	1.15
		45	18.15	1.03	19.28	1.07	20.40	1.11	21.22	1.12	22.66	1.14	23.79	1.16
		50	18.14	1.04	19.26	1.08	20.39	1.12	21.20	1.14	22.64	1.16	23.77	1.18
		55	18.12	1.06	19.25	1.10	20.37	1.14	21.19	1.15	22.62	1.17	23.75	1.20
		60	18.11	1.07	19.23	1.11	20.36	1.15	21.17	1.17	22.61	1.19	23.73	1.21
		65	18.09	1.09	19.22	1.13	20.34	1.17	21.15	1.18	22.59	1.20	23.71	1.23
		70	18.08	1.10	19.20	1.14	20.33	1.18	21.14	1.19	22.57	1.22	23.69	1.24
		75	17.65	1.16	18.77	1.20	19.89	1.24	20.69	1.26	22.13	1.28	23.25	1.31
		80	17.21	1.22	18.33	1.26	19.45	1.31	20.25	1.32	21.68	1.35	22.80	1.38
		85	16.78	1.28	17.89	1.32	19.01	1.37	19.81	1.39	21.24	1.41	22.35	1.44
		90	16.35	1.34	17.46	1.39	18.57	1.44	19.37	1.45	20.80	1.48	21.91	1.51
		95	15.88	1.40	16.99	1.45	18.09	1.50	<b>18.60</b>	<b>1.52</b>	20.31	1.55	21.41	1.58
		100	15.49	1.46	16.60	1.51	17.71	1.56	18.36	1.58	19.92	1.61	21.02	1.64
		105	15.11	1.51	16.21	1.57	17.32	1.63	18.12	1.65	19.53	1.68	20.64	1.71
		110	14.72	1.57	15.83	1.63	16.93	1.69	17.73	1.71	19.14	1.74	20.25	1.78
		115	14.33	1.63	15.44	1.69	16.55	1.75	17.34	1.77	18.76	1.81	19.86	1.84
	118	14.10	1.67	15.21	1.73	16.31	1.79	17.11	1.81	18.53	1.85	19.63	1.88	
	122	14.02	1.72	15.13	1.78	16.24	1.84	17.04	1.87	18.45	1.90	19.56	1.94	
	14	18.23	0.95	19.37	0.98	20.50	1.02	21.32	1.03	22.76	1.05	23.90	1.07	
	20	18.22	0.96	19.35	1.00	20.48	1.03	21.30	1.05	22.75	1.07	23.88	1.09	
	25	18.21	0.98	19.34	1.01	20.47	1.05	21.28	1.06	22.73	1.08	23.86	1.10	
	30	18.19	0.99	19.32	1.03	20.45	1.06	21.27	1.08	22.71	1.10	23.84	1.12	
	35	18.18	1.00	19.31	1.04	20.44	1.08	21.25	1.09	22.69	1.11	23.82	1.13	
	40	18.16	1.02	19.29	1.05	20.42	1.09	21.23	1.11	22.68	1.13	23.80	1.15	
	45	18.15	1.03	19.28	1.07	20.40	1.11	21.22	1.12	22.66	1.14	23.79	1.16	
	50	18.14	1.04	19.26	1.08	20.39	1.12	21.20	1.14	22.64	1.16	23.77	1.18	
	55	18.12	1.06	19.25	1.10	20.37	1.14	21.19	1.15	22.62	1.17	23.75	1.20	
	60	18.11	1.07	19.23	1.11	20.36	1.15	21.17	1.17	22.61	1.19	23.73	1.21	
	65	18.09	1.09	19.22	1.13	20.34	1.17	21.15	1.18	22.59	1.20	23.71	1.23	
	70	18.08	1.10	19.20	1.14	20.33	1.18	21.14	1.19	22.57	1.22	23.69	1.24	
	75	17.65	1.16	18.77	1.20	19.89	1.24	20.69	1.26	22.13	1.28	23.25	1.31	
	80	17.21	1.22	18.33	1.26	19.45	1.31	20.25	1.32	21.68	1.35	22.80	1.38	
	85	16.78	1.28	17.89	1.32	19.01	1.37	19.81	1.39	21.24	1.41	22.35	1.44	
	90	16.35	1.34	17.46	1.39	18.57	1.44	19.37	1.45	20.80	1.48	21.91	1.51	
	95	15.88	1.40	16.99	1.45	18.09	1.50	<b>18.60</b>	<b>1.52</b>	20.31	1.55	21.41	1.58	
	100	15.49	1.46	16.60	1.51	17.71	1.56	18.36	1.58	19.92	1.61	21.02	1.64	
	105	15.11	1.51	16.21	1.57	17.32	1.63	18.12	1.65	19.53	1.68	20.64	1.71	
110	14.72	1.57	15.83	1.63	16.93	1.69	17.73	1.71	19.14	1.74	20.25	1.78		
115	14.33	1.63	15.44	1.69	16.55	1.75	17.34	1.77	18.76	1.81	19.86	1.84		
118	14.10	1.67	15.21	1.73	16.31	1.79	17.11	1.81	18.53	1.85	19.63	1.88		
122	14.02	1.72	15.13	1.78	16.24	1.84	17.04	1.87	18.45	1.90	19.56	1.94		

TC = Total Capacity (kBtu/h).

PI = Power Input (kW).

Nominal capacity as rated: 0 ft. above sea level with 25 ft. of refrigerant piping.  
0 ft. level difference between outdoor and indoor units.

Nominal cooling capacity rating obtained with air entering the indoor unit at 80°F dry bulb (DB) and 67°F wet bulb (WB), and outdoor ambient conditions of 95°F dry bulb (DB) and 75°F wet bulb (WB).

The shaded rows indicate reference data. When operating at this temperature, these values can be different if the system is not running consistently.

# PERFORMANCE DATA

## Cooling Capacity Tables

MULTI F  
MULTI F MAX

Table 38: LMU247HV Cooling Capacity Table — Mixed Indoor Units.

Connected Indoor Units	Combination Capacity Index	Outdoor Air Temp. (°F DB)	Indoor Air Temp. °F DB / °F WB											
			68 / 57		73 / 61		77 / 64		80 / 67		86 / 72		90 / 75	
			TC	PI	TC	PI	TC	PI	TC	PI	TC	PI	TC	PI
Two (2) Mixed Indoor Units	12 + 18	14	18.23	0.95	19.37	0.98	20.50	1.02	21.32	1.03	22.76	1.05	23.90	1.07
		20	18.22	0.96	19.35	1.00	20.48	1.03	21.30	1.05	22.75	1.07	23.88	1.09
		25	18.21	0.98	19.34	1.01	20.47	1.05	21.28	1.06	22.73	1.08	23.86	1.10
		30	18.19	0.99	19.32	1.03	20.45	1.06	21.27	1.08	22.71	1.10	23.84	1.12
		35	18.18	1.00	19.31	1.04	20.44	1.08	21.25	1.09	22.69	1.11	23.82	1.13
		40	18.16	1.02	19.29	1.05	20.42	1.09	<b>21.23</b>	<b>1.11</b>	22.68	1.13	23.80	1.15
		45	18.15	1.03	19.28	1.07	20.40	1.11	21.22	1.12	22.66	1.14	23.79	1.16
		50	18.14	1.04	19.26	1.08	20.39	1.12	21.20	1.14	22.64	1.16	23.77	1.18
		55	18.12	1.06	19.25	1.10	20.37	1.14	21.19	1.15	22.62	1.17	23.75	1.20
		60	18.11	1.07	19.23	1.11	20.36	1.15	21.17	1.17	22.61	1.19	23.73	1.21
		65	18.09	1.09	19.22	1.13	20.34	1.17	21.15	1.18	22.59	1.20	23.71	1.23
		70	18.08	1.10	19.20	1.14	20.33	1.18	21.14	1.19	22.57	1.22	23.69	1.24
		75	17.65	1.16	18.77	1.20	19.89	1.24	20.69	1.26	22.13	1.28	23.25	1.31
		80	17.21	1.22	18.33	1.26	19.45	1.31	20.25	1.32	21.68	1.35	22.80	1.38
		85	16.78	1.28	17.89	1.32	19.01	1.37	19.81	1.39	21.24	1.41	22.35	1.44
		90	16.35	1.34	17.46	1.39	18.57	1.44	19.37	1.45	20.80	1.48	21.91	1.51
		95	15.88	1.40	16.99	1.45	18.09	1.50	<b>18.60</b>	<b>1.52</b>	20.31	1.55	21.41	1.58
		100	15.49	1.46	16.60	1.51	17.71	1.56	18.36	1.58	19.92	1.61	21.02	1.64
		105	15.11	1.51	16.21	1.57	17.32	1.63	18.12	1.65	19.53	1.68	20.64	1.71
		110	14.72	1.57	15.83	1.63	16.93	1.69	17.73	1.71	19.14	1.74	20.25	1.78
115	14.33	1.63	15.44	1.69	16.55	1.75	17.34	1.77	18.76	1.81	19.86	1.84		
118	14.10	1.67	15.21	1.73	16.31	1.79	17.11	1.81	18.53	1.85	19.63	1.88		
122	14.02	1.72	15.13	1.78	16.24	1.84	17.04	1.87	18.45	1.90	19.56	1.94		
Three (3) Mixed Indoor Units	9 + 9 + 9	14	18.23	0.92	19.37	0.96	20.50	0.99	21.32	1.01	22.76	1.02	23.90	1.04
		20	18.22	0.94	19.35	0.97	20.48	1.01	21.30	1.02	22.75	1.04	23.88	1.06
		25	18.21	0.95	19.34	0.99	20.47	1.02	21.28	1.03	22.73	1.05	23.86	1.07
		30	18.19	0.96	19.32	1.00	20.45	1.04	21.27	1.05	22.71	1.07	23.84	1.09
		35	18.18	0.98	19.31	1.01	20.44	1.05	21.25	1.06	22.69	1.08	23.82	1.10
		40	18.16	0.99	19.29	1.03	20.42	1.07	<b>21.23</b>	<b>1.08</b>	22.68	1.10	23.80	1.12
		45	18.15	1.00	19.28	1.04	20.40	1.08	21.22	1.09	22.66	1.11	23.79	1.13
		50	18.14	1.02	19.26	1.06	20.39	1.09	21.20	1.11	22.64	1.13	23.77	1.15
		55	18.12	1.03	19.25	1.07	20.37	1.11	21.19	1.12	22.62	1.14	23.75	1.16
		60	18.11	1.04	19.23	1.08	20.36	1.12	21.17	1.14	22.61	1.16	23.73	1.18
		65	18.09	1.06	19.22	1.10	20.34	1.14	21.15	1.15	22.59	1.17	23.71	1.19
		70	18.08	1.07	19.20	1.11	20.33	1.15	21.14	1.16	22.57	1.19	23.69	1.21
		75	17.65	1.13	18.77	1.17	19.89	1.21	20.69	1.23	22.13	1.25	23.25	1.27
		80	17.21	1.19	18.33	1.23	19.45	1.27	20.25	1.29	21.68	1.31	22.80	1.34
		85	16.78	1.24	17.89	1.29	19.01	1.34	19.81	1.35	21.24	1.38	22.35	1.41
		90	16.35	1.30	17.46	1.35	18.57	1.40	19.37	1.42	20.80	1.44	21.91	1.47
		95	15.88	1.36	16.99	1.41	18.09	1.46	<b>18.60</b>	<b>1.48</b>	20.31	1.51	21.41	1.54
		100	15.49	1.42	16.60	1.47	17.71	1.52	18.36	1.54	19.92	1.57	21.02	1.60
		105	15.11	1.48	16.21	1.53	17.32	1.59	18.12	1.60	19.53	1.63	20.64	1.67
		110	14.72	1.53	15.83	1.59	16.93	1.65	17.73	1.67	19.14	1.70	20.25	1.73
115	14.33	1.59	15.44	1.65	16.55	1.71	17.34	1.73	18.76	1.76	19.86	1.80		
118	14.10	1.63	15.21	1.69	16.31	1.75	17.11	1.77	18.53	1.80	19.63	1.84		
122	14.02	1.67	15.13	1.73	16.24	1.80	17.04	1.82	18.45	1.85	19.56	1.89		

TC = Total Capacity (kBtu/h).

PI = Power Input (kW).

Nominal capacity as rated: 0 ft. above sea level with 25 ft. of refrigerant piping.  
0 ft. level difference between outdoor and indoor units.

Nominal cooling capacity rating obtained with air entering the indoor unit at 80°F dry bulb (DB) and 67°F wet bulb (WB), and outdoor ambient conditions of 95°F dry bulb (DB) and 75°F wet bulb (WB).

The shaded table rows indicate reference data. When operating at this temperature, these values can be different if the system is not running consistently.



Multi F and Multi F MAX Heat Pump System Engineering Manual

Table 39: LMU247HV Cooling Capacity Table — Mixed Indoor Units.

Connected Indoor Units	Combination Capacity Index	Outdoor Air Temp. (°F DB)	Indoor Air Temp. °F DB / °F WB											
			68 / 57		73 / 61		77 / 64		80 / 67		86 / 72		90 / 75	
			TC	PI	TC	PI	TC	PI	TC	PI	TC	PI	TC	PI
Three (3) Mixed Indoor Units	9 + 9 + 12	14	18.23	0.92	19.37	0.96	20.50	0.99	21.32	1.01	22.76	1.02	23.90	1.04
		20	18.22	0.94	19.35	0.97	20.48	1.01	21.30	1.02	22.75	1.04	23.88	1.06
		25	18.21	0.95	19.34	0.99	20.47	1.02	21.28	1.03	22.73	1.05	23.86	1.07
		30	18.19	0.96	19.32	1.00	20.45	1.04	21.27	1.05	22.71	1.07	23.84	1.09
		35	18.18	0.98	19.31	1.01	20.44	1.05	21.25	1.06	22.69	1.08	23.82	1.10
		40	18.16	0.99	19.29	1.03	20.42	1.07	21.23	1.08	22.68	1.10	23.80	1.12
		45	18.15	1.00	19.28	1.04	20.40	1.08	21.22	1.09	22.66	1.11	23.79	1.13
		50	18.14	1.02	19.26	1.06	20.39	1.09	21.20	1.11	22.64	1.13	23.77	1.15
		55	18.12	1.03	19.25	1.07	20.37	1.11	21.19	1.12	22.62	1.14	23.75	1.16
		60	18.11	1.04	19.23	1.08	20.36	1.12	21.17	1.14	22.61	1.16	23.73	1.18
		65	18.09	1.06	19.22	1.10	20.34	1.14	21.15	1.15	22.59	1.17	23.71	1.19
		70	18.08	1.07	19.20	1.11	20.33	1.15	21.14	1.16	22.57	1.19	23.69	1.21
		75	17.65	1.13	18.77	1.17	19.89	1.21	20.69	1.23	22.13	1.25	23.25	1.27
		80	17.21	1.19	18.33	1.23	19.45	1.27	20.25	1.29	21.68	1.31	22.80	1.34
		85	16.78	1.24	17.89	1.29	19.01	1.34	19.81	1.35	21.24	1.38	22.35	1.41
		90	16.35	1.30	17.46	1.35	18.57	1.40	19.37	1.42	20.80	1.44	21.91	1.47
		95	15.88	1.36	16.99	1.41	18.09	1.46	<b>18.60</b>	<b>1.48</b>	20.31	1.51	21.41	1.54
		100	15.49	1.42	16.60	1.47	17.71	1.52	18.36	1.54	19.92	1.57	21.02	1.60
	105	15.11	1.48	16.21	1.53	17.32	1.59	18.12	1.60	19.53	1.63	20.64	1.67	
	110	14.72	1.53	15.83	1.59	16.93	1.65	17.73	1.67	19.14	1.70	20.25	1.73	
	115	14.33	1.59	15.44	1.65	16.55	1.71	17.34	1.73	18.76	1.76	19.86	1.80	
	118	14.10	1.63	15.21	1.69	16.31	1.75	17.11	1.77	18.53	1.80	19.63	1.84	
	122	14.02	1.67	15.13	1.73	16.24	1.80	17.04	1.82	18.45	1.85	19.56	1.89	
	9 + 12 + 12	14	18.23	0.92	19.37	0.96	20.50	0.99	21.32	1.01	22.76	1.02	23.90	1.04
		20	18.22	0.94	19.35	0.97	20.48	1.01	21.30	1.02	22.75	1.04	23.88	1.06
		25	18.21	0.95	19.34	0.99	20.47	1.02	21.28	1.03	22.73	1.05	23.86	1.07
		30	18.19	0.96	19.32	1.00	20.45	1.04	21.27	1.05	22.71	1.07	23.84	1.09
		35	18.18	0.98	19.31	1.01	20.44	1.05	21.25	1.06	22.69	1.08	23.82	1.10
		40	18.16	0.99	19.29	1.03	20.42	1.07	21.23	1.08	22.68	1.10	23.80	1.12
		45	18.15	1.00	19.28	1.04	20.40	1.08	21.22	1.09	22.66	1.11	23.79	1.13
		50	18.14	1.02	19.26	1.06	20.39	1.09	21.20	1.11	22.64	1.13	23.77	1.15
		55	18.12	1.03	19.25	1.07	20.37	1.11	21.19	1.12	22.62	1.14	23.75	1.16
		60	18.11	1.04	19.23	1.08	20.36	1.12	21.17	1.14	22.61	1.16	23.73	1.18
		65	18.09	1.06	19.22	1.10	20.34	1.14	21.15	1.15	22.59	1.17	23.71	1.19
		70	18.08	1.07	19.20	1.11	20.33	1.15	21.14	1.16	22.57	1.19	23.69	1.21
		75	17.65	1.13	18.77	1.17	19.89	1.21	20.69	1.23	22.13	1.25	23.25	1.27
		80	17.21	1.19	18.33	1.23	19.45	1.27	20.25	1.29	21.68	1.31	22.80	1.34
		85	16.78	1.24	17.89	1.29	19.01	1.34	19.81	1.35	21.24	1.38	22.35	1.41
		90	16.35	1.30	17.46	1.35	18.57	1.40	19.37	1.42	20.80	1.44	21.91	1.47
		95	15.88	1.36	16.99	1.41	18.09	1.46	<b>18.60</b>	<b>1.48</b>	20.31	1.51	21.41	1.54
		100	15.49	1.42	16.60	1.47	17.71	1.52	18.36	1.54	19.92	1.57	21.02	1.60
	105	15.11	1.48	16.21	1.53	17.32	1.59	18.12	1.60	19.53	1.63	20.64	1.67	
110	14.72	1.53	15.83	1.59	16.93	1.65	17.73	1.67	19.14	1.70	20.25	1.73		
115	14.33	1.59	15.44	1.65	16.55	1.71	17.34	1.73	18.76	1.76	19.86	1.80		
118	14.10	1.63	15.21	1.69	16.31	1.75	17.11	1.77	18.53	1.80	19.63	1.84		
122	14.02	1.67	15.13	1.73	16.24	1.80	17.04	1.82	18.45	1.85	19.56	1.89		

TC = Total Capacity (kBtu/h).

PI = Power Input (kW).

Nominal capacity as rated: 0 ft. above sea level with 25 ft. of refrigerant piping.  
0 ft. level difference between outdoor and indoor units.

Nominal cooling capacity rating obtained with air entering the indoor unit at 80°F dry bulb (DB) and 67°F wet bulb (WB), and outdoor ambient conditions of 95°F dry bulb (DB) and 75°F wet bulb (WB).

The shaded table rows indicate reference data. When operating at this temperature, these values can be different if the system is not running consistently.

# PERFORMANCE DATA

## Cooling Capacity Tables

MULTI F  
MULTI F MAX

Table 40: LMU369HV Cooling Capacity Table — Non-Ducted Indoor Units.

Connected Indoor Units	Combination Capacity Index	Outdoor Air Temp. (°F DB)	Indoor Air Temp. °F DB / °F WB											
			68 / 57		73 / 61		77 / 64		80 / 67		86 / 72		90 / 75	
			TC	PI	TC	PI	TC	PI	TC	PI	TC	PI	TC	PI
Two (2) Non-Ducted Indoor Units	9 + 9	14	17.65	1.19	18.74	1.23	19.84	1.28	20.63	1.29	22.03	1.32	23.12	1.34
		20	17.63	1.21	18.73	1.25	19.82	1.30	20.61	1.31	22.01	1.34	23.11	1.36
		25	17.62	1.22	18.71	1.27	19.81	1.31	20.60	1.33	22.00	1.35	23.09	1.38
		30	17.60	1.24	18.70	1.29	19.79	1.33	20.58	1.35	21.98	1.37	23.07	1.40
		35	17.59	1.26	18.68	1.30	19.78	1.35	20.57	1.37	21.96	1.39	23.05	1.42
		40	17.58	1.27	18.67	1.32	19.76	1.37	20.55	1.38	21.94	1.41	23.04	1.44
		45	17.56	1.29	18.66	1.34	19.75	1.39	20.53	1.40	21.93	1.43	23.02	1.46
		50	17.55	1.31	18.64	1.36	19.73	1.41	20.52	1.42	21.91	1.45	23.00	1.48
		55	17.54	1.33	18.63	1.37	19.72	1.42	20.50	1.44	21.89	1.47	22.98	1.50
		60	17.52	1.34	18.61	1.39	19.70	1.44	20.49	1.46	21.88	1.49	22.97	1.52
		65	17.51	1.36	18.60	1.41	19.69	1.46	20.47	1.48	21.86	1.51	22.95	1.54
		70	17.50	1.38	18.58	1.43	19.67	1.48	20.46	1.50	21.84	1.52	22.93	1.56
		75	17.08	1.45	18.16	1.50	19.24	1.56	20.03	1.58	21.41	1.61	22.50	1.64
		80	16.66	1.53	17.74	1.58	18.82	1.64	19.60	1.66	20.98	1.69	22.06	1.72
		85	16.24	1.60	17.32	1.66	18.40	1.72	19.17	1.74	20.55	1.77	21.63	1.81
		90	15.82	1.67	16.90	1.74	17.97	1.80	18.75	1.82	20.12	1.85	21.20	1.89
		95	15.37	1.75	16.44	1.81	17.51	1.88	18.00	1.90	19.65	1.94	20.72	1.97
		100	14.99	1.82	16.06	1.89	17.13	1.96	17.77	1.98	19.28	2.02	20.35	2.06
	105	14.62	1.90	15.69	1.97	16.76	2.04	17.53	2.06	18.90	2.10	19.97	2.14	
	110	14.24	1.97	15.32	2.04	16.39	2.12	17.16	2.14	18.53	2.18	19.60	2.23	
	115	13.87	2.05	14.94	2.12	16.01	2.20	16.79	2.22	18.15	2.26	19.22	2.31	
	118	13.65	2.09	14.72	2.17	15.79	2.25	16.56	2.27	17.93	2.31	19.00	2.36	
	122	13.57	2.15	14.64	2.23	15.71	2.31	16.49	2.34	17.85	2.38	18.92	2.43	
	9 + 12	14	20.59	1.32	21.86	1.37	23.14	1.42	24.07	1.43	25.70	1.46	26.98	1.49
		20	20.57	1.34	21.85	1.39	23.13	1.44	24.05	1.46	25.68	1.48	26.96	1.51
		25	20.55	1.36	21.83	1.41	23.11	1.46	24.03	1.48	25.66	1.50	26.94	1.53
		30	20.54	1.38	21.81	1.43	23.09	1.48	24.01	1.50	25.64	1.52	26.92	1.56
		35	20.52	1.40	21.80	1.45	23.07	1.50	23.99	1.52	25.62	1.55	26.90	1.58
		40	20.51	1.42	21.78	1.47	23.05	1.52	23.97	1.54	25.60	1.57	26.88	1.60
		45	20.49	1.43	21.76	1.49	23.04	1.54	23.96	1.56	25.58	1.59	26.86	1.62
		50	20.48	1.45	21.75	1.51	23.02	1.56	23.94	1.58	25.56	1.61	26.83	1.64
		55	20.46	1.47	21.73	1.53	23.00	1.58	23.92	1.60	25.54	1.63	26.81	1.66
		60	20.44	1.49	21.71	1.55	22.98	1.60	23.90	1.62	25.52	1.65	26.79	1.68
		65	20.43	1.51	21.70	1.57	22.97	1.62	23.88	1.64	25.50	1.67	26.77	1.71
		70	20.41	1.53	21.68	1.58	22.95	1.64	23.86	1.66	25.48	1.69	26.75	1.73
		75	19.92	1.61	21.19	1.67	22.45	1.73	23.36	1.75	24.98	1.78	26.25	1.82
		80	19.43	1.69	20.69	1.76	21.95	1.82	22.87	1.84	24.48	1.88	25.74	1.91
	85	18.94	1.78	20.20	1.84	21.46	1.91	22.37	1.93	23.98	1.97	25.24	2.01	
	90	18.46	1.86	19.71	1.93	20.97	2.00	21.87	2.02	23.48	2.06	24.73	2.10	
	95	17.93	1.94	19.18	2.01	20.43	2.09	21.00	2.11	22.93	2.15	24.17	2.19	
	100	17.49	2.02	18.74	2.10	19.99	2.17	20.73	2.20	22.49	2.24	23.74	2.29	
	105	17.06	2.11	18.30	2.18	19.55	2.26	20.46	2.29	22.05	2.33	23.30	2.38	
110	16.62	2.19	17.87	2.27	19.12	2.35	20.02	2.38	21.62	2.42	22.86	2.47		
115	16.18	2.27	17.43	2.35	18.68	2.44	19.58	2.47	21.18	2.51	22.43	2.57		
118	15.92	2.32	17.17	2.41	18.42	2.49	19.32	2.52	20.92	2.57	22.17	2.62		
122	15.83	2.39	17.08	2.47	18.33	2.56	19.23	2.59	20.83	2.64	22.08	2.70		

TC = Total Capacity (kBtu/h).

PI = Power Input (kW).

Nominal capacity as rated: 0 ft. above sea level with 25 ft. of refrigerant piping.  
0 ft. level difference between outdoor and indoor units.

Nominal cooling capacity rating obtained with air entering the indoor unit at 80°F dry bulb (DB) and 67°F wet bulb (WB), and outdoor ambient conditions of 95°F dry bulb (DB) and 75°F wet bulb (WB).

The shaded table rows indicate reference data. When operating at this temperature, these values can be different if the system is not running consistently.



Multi F and Multi F MAX Heat Pump System Engineering Manual

Table 41: LMU369HV Cooling Capacity Table — Non-Ducted Indoor Units (continued).

Connected Indoor Units	Combination Capacity Index	Outdoor Air Temp. (°F DB)	Indoor Air Temp. °F DB / °F WB											
			68 / 57		73 / 61		77 / 64		80 / 67		86 / 72		90 / 75	
			TC	PI	TC	PI	TC	PI	TC	PI	TC	PI	TC	PI
Two (2) Non-Ducted Indoor Units	12 + 12	14	23.53	1.45	24.99	1.50	26.45	1.56	27.50	1.58	29.37	1.61	30.83	1.64
		20	23.51	1.47	24.97	1.53	26.43	1.58	27.48	1.60	29.35	1.63	30.81	1.66
		25	23.49	1.49	24.95	1.55	26.41	1.60	27.46	1.62	29.33	1.65	30.79	1.69
		30	23.47	1.51	24.93	1.57	26.39	1.63	27.44	1.65	29.30	1.68	30.76	1.71
		35	23.46	1.54	24.91	1.59	26.37	1.65	27.42	1.67	29.28	1.70	30.74	1.73
		40	23.44	1.56	24.89	1.61	26.35	1.67	27.40	1.69	29.26	1.72	30.72	1.76
		45	23.42	1.58	24.87	1.63	26.33	1.69	27.38	1.71	29.24	1.75	30.69	1.78
		50	23.40	1.60	24.85	1.66	26.31	1.72	27.36	1.74	29.21	1.77	30.67	1.80
		55	23.38	1.62	24.84	1.68	26.29	1.74	27.34	1.76	29.19	1.79	30.64	1.83
		60	23.37	1.64	24.82	1.70	26.27	1.76	27.32	1.78	29.17	1.82	30.62	1.85
		65	23.35	1.66	24.80	1.72	26.25	1.78	27.29	1.80	29.15	1.84	30.60	1.88
		70	23.33	1.68	24.78	1.74	26.23	1.81	27.27	1.83	29.13	1.86	30.57	1.90
		75	22.77	1.77	24.21	1.84	25.66	1.90	26.70	1.93	28.55	1.96	29.99	2.00
		80	22.21	1.86	23.65	1.93	25.09	2.00	26.13	2.02	27.97	2.06	29.42	2.10
		85	21.65	1.95	23.09	2.02	24.53	2.10	25.57	2.12	27.40	2.16	28.84	2.21
		90	21.09	2.04	22.53	2.12	23.96	2.20	25.00	2.22	26.83	2.26	28.27	2.31
		95	20.49	2.13	21.92	2.21	23.35	2.29	<b>24.00</b>	<b>2.32</b>	26.20	2.36	27.63	2.41
		100	19.99	2.23	21.42	2.31	22.85	2.39	23.69	2.42	25.70	2.46	27.13	2.51
		105	19.49	2.32	20.92	2.40	22.35	2.49	23.38	2.52	25.20	2.56	26.63	2.62
		110	18.99	2.41	20.42	2.49	21.85	2.59	22.88	2.62	24.70	2.66	26.13	2.72
		115	18.49	2.50	19.92	2.59	21.35	2.68	22.38	2.71	24.20	2.77	25.63	2.82
		118	18.19	2.55	19.62	2.65	21.05	2.74	22.08	2.77	23.90	2.83	25.33	2.88
	122	18.10	2.62	19.52	2.72	20.95	2.82	21.98	2.85	23.81	2.91	25.23	2.96	
	14	26.47	1.51	28.11	1.57	29.76	1.63	30.94	1.65	33.04	1.68	34.69	1.71	
	20	26.45	1.54	28.09	1.59	29.73	1.65	30.92	1.67	33.02	1.70	34.66	1.73	
	25	26.43	1.56	28.07	1.61	29.71	1.67	30.90	1.69	32.99	1.72	34.63	1.76	
	30	26.41	1.58	28.05	1.64	29.69	1.70	30.87	1.72	32.97	1.75	34.61	1.78	
	35	26.39	1.60	28.03	1.66	29.66	1.72	30.85	1.74	32.94	1.77	34.58	1.81	
	40	26.37	1.62	28.00	1.68	29.64	1.74	30.82	1.76	32.92	1.80	34.55	1.83	
	45	26.35	1.64	27.98	1.71	29.62	1.77	30.80	1.79	32.89	1.82	34.53	1.86	
	50	26.33	1.67	27.96	1.73	29.60	1.79	30.78	1.81	32.87	1.85	34.50	1.88	
	55	26.31	1.69	27.94	1.75	29.57	1.81	30.75	1.83	32.84	1.87	34.48	1.91	
	60	26.29	1.71	27.92	1.77	29.55	1.84	30.73	1.86	32.82	1.89	34.45	1.93	
	65	26.27	1.73	27.90	1.80	29.53	1.86	30.71	1.88	32.79	1.92	34.42	1.96	
	70	26.25	1.75	27.88	1.82	29.51	1.88	30.68	1.91	32.77	1.94	34.40	1.98	
	75	25.61	1.85	27.24	1.92	28.87	1.99	30.04	2.01	32.12	2.05	33.74	2.09	
	80	24.98	1.94	26.60	2.01	28.23	2.09	29.40	2.11	31.47	2.15	33.09	2.19	
	85	24.36	2.04	25.97	2.11	27.59	2.19	28.76	2.21	30.83	2.26	32.45	2.30	
	90	23.73	2.13	25.34	2.21	26.96	2.29	28.12	2.32	30.19	2.36	31.80	2.41	
	95	23.05	2.23	24.66	2.31	26.26	2.39	<b>27.00</b>	<b>2.42</b>	29.48	2.47	31.08	2.51	
	100	22.49	2.32	24.10	2.41	25.70	2.49	26.65	2.52	28.91	2.57	30.52	2.62	
	105	21.93	2.42	23.53	2.50	25.14	2.60	26.30	2.63	28.35	2.67	29.96	2.73	
110	21.37	2.51	22.97	2.60	24.58	2.70	25.74	2.73	27.79	2.78	29.40	2.84		
115	20.81	2.61	22.41	2.70	24.02	2.80	25.18	2.83	27.23	2.88	28.84	2.94		
118	20.47	2.66	22.08	2.76	23.68	2.86	24.84	2.89	26.89	2.95	28.50	3.01		
122	20.36	2.74	21.96	2.84	23.57	2.94	24.73	2.98	26.78	3.03	28.39	3.09		

TC = Total Capacity (kBtu/h).

PI = Power Input (kW).

Nominal capacity as rated: 0 ft. above sea level with 25 ft. of refrigerant piping.  
0 ft. level difference between outdoor and indoor units.

Nominal cooling capacity rating obtained with air entering the indoor unit at 80°F dry bulb (DB) and 67°F wet bulb (WB), and outdoor ambient conditions of 95°F dry bulb (DB) and 75°F wet bulb (WB).

The shaded table rows indicate reference data. When operating at this temperature, these values can be different if the system is not running consistently.

# PERFORMANCE DATA

## Cooling Capacity Tables

MULTI F  
MULTI F MAX

Table 42: LMU369HV Cooling Capacity Table — Non-Ducted Indoor Units (continued).

Connected Indoor Units	Combination Capacity Index	Outdoor Air Temp. (°F DB)	Indoor Air Temp. °F DB / °F WB											
			68 / 57		73 / 61		77 / 64		80 / 67		86 / 72		90 / 75	
			TC	PI	TC	PI	TC	PI	TC	PI	TC	PI	TC	PI
Two (2) Non-Ducted Indoor Units	12 + 18	14	29.41	1.63	31.24	1.69	33.06	1.75	34.38	1.77	36.71	1.80	38.54	1.84
		20	29.39	1.65	31.21	1.71	33.04	1.77	34.35	1.79	36.69	1.83	38.51	1.86
		25	29.36	1.67	31.19	1.73	33.01	1.80	34.33	1.82	36.66	1.85	38.48	1.89
		30	29.34	1.70	31.16	1.76	32.99	1.82	34.30	1.84	36.63	1.88	38.45	1.92
		35	29.32	1.72	31.14	1.78	32.96	1.85	34.28	1.87	36.60	1.90	38.42	1.94
		40	29.30	1.74	31.12	1.81	32.94	1.87	34.25	1.90	36.57	1.93	38.39	1.97
		45	29.27	1.77	31.09	1.83	32.91	1.90	34.22	1.92	36.55	1.96	38.36	2.00
		50	29.25	1.79	31.07	1.86	32.89	1.92	34.20	1.95	36.52	1.98	38.34	2.02
		55	29.23	1.81	31.04	1.88	32.86	1.95	34.17	1.97	36.49	2.01	38.31	2.05
		60	29.21	1.84	31.02	1.90	32.83	1.97	34.14	2.00	36.46	2.03	38.28	2.08
		65	29.18	1.86	31.00	1.93	32.81	2.00	34.12	2.02	36.43	2.06	38.25	2.10
		70	29.16	1.88	30.97	1.95	32.78	2.02	34.09	2.05	36.41	2.09	38.22	2.13
		75	28.46	1.99	30.27	2.06	32.07	2.13	33.38	2.16	35.69	2.20	37.49	2.24
		80	27.76	2.09	29.56	2.16	31.36	2.24	32.66	2.27	34.97	2.31	36.77	2.36
		85	27.06	2.19	28.86	2.27	30.66	2.35	31.96	2.38	34.25	2.42	36.05	2.47
		90	26.37	2.29	28.16	2.37	29.95	2.46	31.25	2.49	33.54	2.54	35.33	2.59
		95	25.61	2.39	27.40	2.48	29.18	2.57	30.50	2.60	32.75	2.65	34.53	2.70
		100	24.99	2.49	26.77	2.59	28.56	2.68	29.61	2.71	32.13	2.76	33.91	2.82
	105	24.37	2.60	26.15	2.69	27.93	2.79	29.22	2.82	31.50	2.87	33.29	2.93	
	110	23.74	2.70	25.53	2.80	27.31	2.90	28.60	2.93	30.88	2.99	32.66	3.05	
	115	23.12	2.80	24.90	2.90	26.69	3.01	27.98	3.04	30.26	3.10	32.04	3.16	
	118	22.74	2.86	24.53	2.96	26.31	3.07	27.60	3.11	29.88	3.17	31.67	3.23	
	122	22.62	2.94	24.40	3.05	26.19	3.16	27.48	3.20	29.76	3.26	31.54	3.32	
	14	32.35	1.80	34.36	1.87	36.37	1.94	37.82	1.96	40.39	2.00	42.40	2.04	
	20	32.33	1.83	34.33	1.89	36.34	1.96	37.79	1.99	40.36	2.02	42.36	2.06	
	25	32.30	1.85	34.31	1.92	36.31	1.99	37.76	2.01	40.32	2.05	42.33	2.09	
	30	32.28	1.88	34.28	1.95	36.28	2.02	37.73	2.04	40.29	2.08	42.30	2.12	
	35	32.25	1.91	34.25	1.98	36.26	2.05	37.70	2.07	40.26	2.11	42.27	2.15	
	40	32.23	1.93	34.23	2.00	36.23	2.08	37.67	2.10	40.23	2.14	42.23	2.18	
	45	32.20	1.96	34.20	2.03	36.20	2.10	37.65	2.13	40.20	2.17	42.20	2.21	
	50	32.18	1.98	34.18	2.06	36.17	2.13	37.62	2.16	40.17	2.20	42.17	2.24	
	55	32.15	2.01	34.15	2.08	36.15	2.16	37.59	2.18	40.14	2.22	42.14	2.27	
	60	32.13	2.04	34.12	2.11	36.12	2.19	37.56	2.21	40.11	2.25	42.10	2.30	
	65	32.10	2.06	34.10	2.14	36.09	2.21	37.53	2.24	40.08	2.28	42.07	2.33	
	70	32.08	2.09	34.07	2.16	36.06	2.24	37.50	2.27	40.05	2.31	42.04	2.36	
	75	31.31	2.20	33.29	2.28	35.28	2.36	36.72	2.39	39.26	2.44	41.24	2.48	
	80	30.53	2.31	32.52	2.40	34.50	2.48	35.93	2.51	38.46	2.56	40.45	2.61	
	85	29.77	2.42	31.75	2.51	33.72	2.61	35.15	2.64	37.68	2.68	39.66	2.74	
	90	29.00	2.54	30.98	2.63	32.95	2.73	34.37	2.76	36.89	2.81	38.87	2.87	
	95	28.17	2.65	30.14	2.75	32.10	2.85	33.50	2.88	36.03	2.93	37.99	2.99	
	100	27.49	2.76	29.45	2.86	31.41	2.97	32.57	3.00	35.34	3.06	37.30	3.12	
	105	26.80	2.88	28.76	2.98	30.73	3.09	32.14	3.12	34.65	3.18	36.62	3.25	
110	26.12	2.99	28.08	3.10	30.04	3.21	31.46	3.25	33.97	3.31	35.93	3.37		
115	25.43	3.10	27.39	3.21	29.36	3.33	30.77	3.37	33.28	3.43	35.24	3.50		
118	25.02	3.17	26.98	3.28	28.94	3.40	30.36	3.44	32.87	3.51	34.83	3.58		
122	24.88	3.26	26.84	3.38	28.81	3.50	30.22	3.54	32.73	3.61	34.69	3.68		

TC = Total Capacity (kBtu/h).

PI = Power Input (kW).

Nominal capacity as rated: 0 ft. above sea level with 25 ft. of refrigerant piping.  
0 ft. level difference between outdoor and indoor units.

Nominal cooling capacity rating obtained with air entering the indoor unit at 80°F dry bulb (DB) and 67°F wet bulb (WB), and outdoor ambient conditions of 95°F dry bulb (DB) and 75°F wet bulb (WB).

The shaded table rows indicate reference data. When operating at this temperature, these values can be different if the system is not running consistently.



Multi F and Multi F MAX Heat Pump System Engineering Manual

Table 43: LMU369HV Cooling Capacity Table — Non-Ducted Indoor Units (continued).

Connected Indoor Units	Combination Capacity Index	Outdoor Air Temp. (°F DB)	Indoor Air Temp. °F DB / °F WB												
			68 / 57		73 / 61		77 / 64		80 / 67		86 / 72		90 / 75		
			TC	PI	TC	PI	TC	PI	TC	PI	TC	PI	TC	PI	
Three (3) Non-Ducted Indoor Units	9 + 9 + 9	14	26.47	1.51	28.11	1.57	29.76	1.63	30.94	1.65	33.04	1.68	34.69	1.71	
		20	26.45	1.54	28.09	1.59	29.73	1.65	30.92	1.67	33.02	1.70	34.66	1.73	
		25	26.43	1.56	28.07	1.61	29.71	1.67	30.90	1.69	32.99	1.72	34.63	1.76	
		30	26.41	1.58	28.05	1.64	29.69	1.70	30.87	1.72	32.97	1.75	34.61	1.78	
		35	26.39	1.60	28.03	1.66	29.66	1.72	30.85	1.74	32.94	1.77	34.58	1.81	
		40	26.37	1.62	28.00	1.68	29.64	1.74	30.82	1.76	32.92	1.80	34.55	1.83	
		45	26.35	1.64	27.98	1.71	29.62	1.77	30.80	1.79	32.89	1.82	34.53	1.86	
		50	26.33	1.67	27.96	1.73	29.60	1.79	30.78	1.81	32.87	1.85	34.50	1.88	
		55	26.31	1.69	27.94	1.75	29.57	1.81	30.75	1.83	32.84	1.87	34.48	1.91	
		60	26.29	1.71	27.92	1.77	29.55	1.84	30.73	1.86	32.82	1.89	34.45	1.93	
		65	26.27	1.73	27.90	1.80	29.53	1.86	30.71	1.88	32.79	1.92	34.42	1.96	
		70	26.25	1.75	27.88	1.82	29.51	1.88	30.68	1.91	32.77	1.94	34.40	1.98	
		75	25.61	1.85	27.24	1.92	28.87	1.99	30.04	2.01	32.12	2.05	33.74	2.09	
		80	24.98	1.94	26.60	2.01	28.23	2.09	29.40	2.11	31.47	2.15	33.09	2.19	
		85	24.36	2.04	25.97	2.11	27.59	2.19	28.76	2.21	30.83	2.26	32.45	2.30	
		90	23.73	2.13	25.34	2.21	26.96	2.29	28.12	2.32	30.19	2.36	31.80	2.41	
		95	23.05	2.23	24.66	2.31	26.26	2.39	<b>27.00</b>	<b>2.42</b>	29.48	2.47	31.08	2.51	
		100	22.49	2.32	24.10	2.41	25.70	2.49	26.65	2.52	28.91	2.57	30.52	2.62	
	105	21.93	2.42	23.53	2.50	25.14	2.60	26.30	2.63	28.35	2.67	29.96	2.73		
	110	21.37	2.51	22.97	2.60	24.58	2.70	25.74	2.73	27.79	2.78	29.40	2.84		
	115	20.81	2.61	22.41	2.70	24.02	2.80	25.18	2.83	27.23	2.88	28.84	2.94		
	118	20.47	2.66	22.08	2.76	23.68	2.86	24.84	2.89	26.89	2.95	28.50	3.01		
	122	20.36	2.74	21.96	2.84	23.57	2.94	24.73	2.98	26.78	3.03	28.39	3.09		
	14	9 + 9 + 12	14	29.41	1.63	31.24	1.69	33.06	1.75	34.38	1.77	36.71	1.80	38.54	1.84
	20		29.39	1.65	31.21	1.71	33.04	1.77	34.35	1.79	36.69	1.83	38.51	1.86	
	25		29.36	1.67	31.19	1.73	33.01	1.80	34.33	1.82	36.66	1.85	38.48	1.89	
	30		29.34	1.70	31.16	1.76	32.99	1.82	34.30	1.84	36.63	1.88	38.45	1.92	
	35		29.32	1.72	31.14	1.78	32.96	1.85	34.28	1.87	36.60	1.90	38.42	1.94	
	40		29.30	1.74	31.12	1.81	32.94	1.87	34.25	1.90	36.57	1.93	38.39	1.97	
	45		29.27	1.77	31.09	1.83	32.91	1.90	34.22	1.92	36.55	1.96	38.36	2.00	
	50		29.25	1.79	31.07	1.86	32.89	1.92	34.20	1.95	36.52	1.98	38.34	2.02	
	55		29.23	1.81	31.04	1.88	32.86	1.95	34.17	1.97	36.49	2.01	38.31	2.05	
	60		29.21	1.84	31.02	1.90	32.83	1.97	34.14	2.00	36.46	2.03	38.28	2.08	
	65		29.18	1.86	31.00	1.93	32.81	2.00	34.12	2.02	36.43	2.06	38.25	2.10	
	70		29.16	1.88	30.97	1.95	32.78	2.02	34.09	2.05	36.41	2.09	38.22	2.13	
	75		28.46	1.99	30.27	2.06	32.07	2.13	33.38	2.16	35.69	2.20	37.49	2.24	
	80		27.76	2.09	29.56	2.16	31.36	2.24	32.66	2.27	34.97	2.31	36.77	2.36	
	85		27.06	2.19	28.86	2.27	30.66	2.35	31.96	2.38	34.25	2.42	36.05	2.47	
	90		26.37	2.29	28.16	2.37	29.95	2.46	31.25	2.49	33.54	2.54	35.33	2.59	
	95		25.61	2.39	27.40	2.48	29.18	2.57	<b>30.00</b>	<b>2.60</b>	32.75	2.65	34.53	2.70	
	100		24.99	2.49	26.77	2.59	28.56	2.68	29.61	2.71	32.13	2.76	33.91	2.82	
	105	24.37	2.60	26.15	2.69	27.93	2.79	29.22	2.82	31.50	2.87	33.29	2.93		
110	23.74	2.70	25.53	2.80	27.31	2.90	28.60	2.93	30.88	2.99	32.66	3.05			
115	23.12	2.80	24.90	2.90	26.69	3.01	27.98	3.04	30.26	3.10	32.04	3.16			
118	22.74	2.86	24.53	2.96	26.31	3.07	27.60	3.11	29.88	3.17	31.67	3.23			
122	22.62	2.94	24.40	3.05	26.19	3.16	27.48	3.20	29.76	3.26	31.54	3.32			

TC = Total Capacity (kBtu/h).

PI = Power Input (kW).

Nominal capacity as rated: 0 ft. above sea level with 25 ft. of refrigerant piping.  
0 ft. level difference between outdoor and indoor units.

Nominal cooling capacity rating obtained with air entering the indoor unit at 80°F dry bulb (DB) and 67°F wet bulb (WB), and outdoor ambient conditions of 95°F dry bulb (DB) and 75°F wet bulb (WB).

The shaded table rows indicate reference data. When operating at this temperature, these values can be different if the system is not running consistently.

# PERFORMANCE DATA

## Cooling Capacity Tables

MULTI F  
MULTI F MAX

Table 44: LMU369HV Cooling Capacity Table — Non-Ducted Indoor Units (continued).

Connected Indoor Units	Combination Capacity Index	Outdoor Air Temp. (°F DB)	Indoor Air Temp. °F DB / °F WB											
			68 / 57		73 / 61		77 / 64		80 / 67		86 / 72		90 / 75	
			TC	PI	TC	PI	TC	PI	TC	PI	TC	PI	TC	PI
Three (3) Non-Ducted Indoor Units	9 + 12 + 12	14	29.41	1.63	31.24	1.69	33.06	1.75	34.38	1.77	36.71	1.80	38.54	1.84
		20	29.39	1.65	31.21	1.71	33.04	1.77	34.35	1.79	36.69	1.83	38.51	1.86
		25	29.36	1.67	31.19	1.73	33.01	1.80	34.33	1.82	36.66	1.85	38.48	1.89
		30	29.34	1.70	31.16	1.76	32.99	1.82	34.30	1.84	36.63	1.88	38.45	1.92
		35	29.32	1.72	31.14	1.78	32.96	1.85	34.28	1.87	36.60	1.90	38.42	1.94
		40	29.30	1.74	31.12	1.81	32.94	1.87	34.25	1.90	36.57	1.93	38.39	1.97
		45	29.27	1.77	31.09	1.83	32.91	1.90	34.22	1.92	36.55	1.96	38.36	2.00
		50	29.25	1.79	31.07	1.86	32.89	1.92	34.20	1.95	36.52	1.98	38.34	2.02
		55	29.23	1.81	31.04	1.88	32.86	1.95	34.17	1.97	36.49	2.01	38.31	2.05
		60	29.21	1.84	31.02	1.90	32.83	1.97	34.14	2.00	36.46	2.03	38.28	2.08
		65	29.18	1.86	31.00	1.93	32.81	2.00	34.12	2.02	36.43	2.06	38.25	2.10
		70	29.16	1.88	30.97	1.95	32.78	2.02	34.09	2.05	36.41	2.09	38.22	2.13
		75	28.46	1.99	30.27	2.06	32.07	2.13	33.38	2.16	35.69	2.20	37.49	2.24
		80	27.76	2.09	29.56	2.16	31.36	2.24	32.66	2.27	34.97	2.31	36.77	2.36
		85	27.06	2.19	28.86	2.27	30.66	2.35	31.96	2.38	34.25	2.42	36.05	2.47
		90	26.37	2.29	28.16	2.37	29.95	2.46	31.25	2.49	33.54	2.54	35.33	2.59
		95	25.61	2.39	27.40	2.48	29.18	2.57	30.50	2.60	32.75	2.65	34.53	2.70
		100	24.99	2.49	26.77	2.59	28.56	2.68	29.61	2.71	32.13	2.76	33.91	2.82
		105	24.37	2.60	26.15	2.69	27.93	2.79	29.22	2.82	31.50	2.87	33.29	2.93
		110	23.74	2.70	25.53	2.80	27.31	2.90	28.60	2.93	30.88	2.99	32.66	3.05
		115	23.12	2.80	24.90	2.90	26.69	3.01	27.98	3.04	30.26	3.10	32.04	3.16
	118	22.74	2.86	24.53	2.96	26.31	3.07	27.60	3.11	29.88	3.17	31.67	3.23	
	122	22.62	2.94	24.40	3.05	26.19	3.16	27.48	3.20	29.76	3.26	31.54	3.32	
	14	12 + 12 + 12	33.33	1.70	35.40	1.76	37.47	1.83	38.96	1.85	41.61	1.88	43.68	1.92
	20		33.30	1.73	35.37	1.79	37.44	1.86	38.94	1.88	41.58	1.91	43.65	1.95
	25		33.28	1.75	35.35	1.82	37.41	1.88	38.91	1.90	41.55	1.94	43.61	1.98
	30		33.25	1.78	35.32	1.84	37.38	1.91	38.88	1.93	41.51	1.97	43.58	2.01
	35		33.23	1.80	35.29	1.87	37.36	1.93	38.85	1.96	41.48	1.99	43.55	2.03
	40		33.20	1.82	35.27	1.89	37.33	1.96	38.82	1.98	41.45	2.02	43.51	2.06
	45		33.18	1.85	35.24	1.92	37.30	1.99	38.79	2.01	41.42	2.05	43.48	2.09
	50		33.15	1.87	35.21	1.94	37.27	2.01	38.76	2.04	41.39	2.07	43.45	2.12
	55		33.13	1.90	35.18	1.97	37.24	2.04	38.73	2.06	41.36	2.10	43.41	2.14
	60		33.10	1.92	35.16	1.99	37.21	2.07	38.70	2.09	41.32	2.13	43.38	2.17
	65		33.08	1.95	35.13	2.02	37.18	2.09	38.67	2.12	41.29	2.16	43.35	2.20
	70		33.05	1.97	35.10	2.04	37.16	2.12	38.64	2.14	41.26	2.18	43.31	2.23
	75		32.26	2.08	34.30	2.15	36.35	2.23	37.83	2.26	40.45	2.30	42.49	2.35
	80		31.46	2.18	33.50	2.26	35.54	2.35	37.02	2.37	39.63	2.42	41.67	2.47
	85		30.67	2.29	32.71	2.37	34.75	2.46	36.22	2.49	38.82	2.54	40.86	2.59
	90		29.88	2.40	31.92	2.48	33.95	2.57	35.42	2.60	38.01	2.65	40.05	2.71
	95		29.03	2.50	31.05	2.59	33.07	2.69	34.60	2.72	37.12	2.77	39.14	2.83
	100		28.32	2.61	30.34	2.70	32.37	2.80	33.56	2.84	36.41	2.89	38.43	2.95
	105		27.61	2.72	29.64	2.81	31.66	2.92	33.12	2.95	35.70	3.01	37.73	3.07
110	26.91		2.82	28.93	2.92	30.95	3.03	32.41	3.07	35.00	3.12	37.02	3.19	
115	26.20		2.93	28.22	3.04	30.24	3.15	31.71	3.18	34.29	3.24	36.31	3.31	
118	25.78	2.99	27.80	3.10	29.82	3.21	31.28	3.25	33.87	3.31	35.89	3.38		
122	25.63	3.08	27.66	3.19	29.68	3.31	31.14	3.34	33.72	3.41	35.75	3.48		

TC = Total Capacity (kBtu/h).

PI = Power Input (kW).

Nominal capacity as rated: 0 ft. above sea level with 25 ft. of refrigerant piping.  
0 ft. level difference between outdoor and indoor units.

Nominal cooling capacity rating obtained with air entering the indoor unit at 80°F dry bulb (DB) and 67°F wet bulb (WB), and outdoor ambient conditions of 95°F dry bulb (DB) and 75°F wet bulb (WB).

The shaded table rows indicate reference data. When operating at this temperature, these values can be different if the system is not running consistently.



Table 45: LMU369HV Cooling Capacity Table — Non-Ducted Indoor Units (continued).

Connected Indoor Units	Combination Capacity Index	Outdoor Air Temp. (°F DB)	Indoor Air Temp. °F DB / °F WB											
			68 / 57		73 / 61		77 / 64		80 / 67		86 / 72		90 / 75	
			TC	PI	TC	PI	TC	PI	TC	PI	TC	PI	TC	PI
Three (3) Non-Ducted Indoor Units	9 + 9 + 18	14	33.33	1.70	35.40	1.76	37.47	1.83	38.96	1.85	41.61	1.88	43.68	1.92
		20	33.30	1.73	35.37	1.79	37.44	1.86	38.94	1.88	41.58	1.91	43.65	1.95
		25	33.28	1.75	35.35	1.82	37.41	1.88	38.91	1.90	41.55	1.94	43.61	1.98
		30	33.25	1.78	35.32	1.84	37.38	1.91	38.88	1.93	41.51	1.97	43.58	2.01
		35	33.23	1.80	35.29	1.87	37.36	1.93	38.85	1.96	41.48	1.99	43.55	2.03
		40	33.20	1.82	35.27	1.89	37.33	1.96	38.82	1.98	41.45	2.02	43.51	2.06
		45	33.18	1.85	35.24	1.92	37.30	1.99	38.79	2.01	41.42	2.05	43.48	2.09
		50	33.15	1.87	35.21	1.94	37.27	2.01	38.76	2.04	41.39	2.07	43.45	2.12
		55	33.13	1.90	35.18	1.97	37.24	2.04	38.73	2.06	41.36	2.10	43.41	2.14
		60	33.10	1.92	35.16	1.99	37.21	2.07	38.70	2.09	41.32	2.13	43.38	2.17
		65	33.08	1.95	35.13	2.02	37.18	2.09	38.67	2.12	41.29	2.16	43.35	2.20
		70	33.05	1.97	35.10	2.04	37.16	2.12	38.64	2.14	41.26	2.18	43.31	2.23
		75	32.26	2.08	34.30	2.15	36.35	2.23	37.83	2.26	40.45	2.30	42.49	2.35
		80	31.46	2.18	33.50	2.26	35.54	2.35	37.02	2.37	39.63	2.42	41.67	2.47
		85	30.67	2.29	32.71	2.37	34.75	2.46	36.22	2.49	38.82	2.54	40.86	2.59
		90	29.88	2.40	31.92	2.48	33.95	2.57	35.42	2.60	38.01	2.65	40.05	2.71
		95	29.03	2.50	31.05	2.59	33.07	2.69	<b>34.00</b>	<b>2.72</b>	37.12	2.77	39.14	2.83
		100	28.32	2.61	30.34	2.70	32.37	2.80	33.56	2.84	36.41	2.89	38.43	2.95
		105	27.61	2.72	29.64	2.81	31.66	2.92	33.12	2.95	35.70	3.01	37.73	3.07
		110	26.91	2.82	28.93	2.92	30.95	3.03	32.41	3.07	35.00	3.12	37.02	3.19
		115	26.20	2.93	28.22	3.04	30.24	3.15	31.71	3.18	34.29	3.24	36.31	3.31
	118	25.78	2.99	27.80	3.10	29.82	3.21	31.28	3.25	33.87	3.31	35.89	3.38	
	122	25.63	3.08	27.66	3.19	29.68	3.31	31.14	3.34	33.72	3.41	35.75	3.48	
	9 + 12 + 18	14	33.33	1.70	35.40	1.76	37.47	1.83	38.96	1.85	41.61	1.88	43.68	1.92
		20	33.30	1.73	35.37	1.79	37.44	1.86	38.94	1.88	41.58	1.91	43.65	1.95
		25	33.28	1.75	35.35	1.82	37.41	1.88	38.91	1.90	41.55	1.94	43.61	1.98
		30	33.25	1.78	35.32	1.84	37.38	1.91	38.88	1.93	41.51	1.97	43.58	2.01
		35	33.23	1.80	35.29	1.87	37.36	1.93	38.85	1.96	41.48	1.99	43.55	2.03
		40	33.20	1.82	35.27	1.89	37.33	1.96	38.82	1.98	41.45	2.02	43.51	2.06
		45	33.18	1.85	35.24	1.92	37.30	1.99	38.79	2.01	41.42	2.05	43.48	2.09
		50	33.15	1.87	35.21	1.94	37.27	2.01	38.76	2.04	41.39	2.07	43.45	2.12
		55	33.13	1.90	35.18	1.97	37.24	2.04	38.73	2.06	41.36	2.10	43.41	2.14
		60	33.10	1.92	35.16	1.99	37.21	2.07	38.70	2.09	41.32	2.13	43.38	2.17
		65	33.08	1.95	35.13	2.02	37.18	2.09	38.67	2.12	41.29	2.16	43.35	2.20
		70	33.05	1.97	35.10	2.04	37.16	2.12	38.64	2.14	41.26	2.18	43.31	2.23
		75	32.26	2.08	34.30	2.15	36.35	2.23	37.83	2.26	40.45	2.30	42.49	2.35
		80	31.46	2.18	33.50	2.26	35.54	2.35	37.02	2.37	39.63	2.42	41.67	2.47
		85	30.67	2.29	32.71	2.37	34.75	2.46	36.22	2.49	38.82	2.54	40.86	2.59
		90	29.88	2.40	31.92	2.48	33.95	2.57	35.42	2.60	38.01	2.65	40.05	2.71
		95	29.03	2.50	31.05	2.59	33.07	2.69	<b>34.00</b>	<b>2.72</b>	37.12	2.77	39.14	2.83
		100	28.32	2.61	30.34	2.70	32.37	2.80	33.56	2.84	36.41	2.89	38.43	2.95
		105	27.61	2.72	29.64	2.81	31.66	2.92	33.12	2.95	35.70	3.01	37.73	3.07
110		26.91	2.82	28.93	2.92	30.95	3.03	32.41	3.07	35.00	3.12	37.02	3.19	
115		26.20	2.93	28.22	3.04	30.24	3.15	31.71	3.18	34.29	3.24	36.31	3.31	
118	25.78	2.99	27.80	3.10	29.82	3.21	31.28	3.25	33.87	3.31	35.89	3.38		
122	25.63	3.08	27.66	3.19	29.68	3.31	31.14	3.34	33.72	3.41	35.75	3.48		

TC = Total Capacity (kBtu/h).

PI = Power Input (kW).

Nominal capacity as rated: 0 ft. above sea level with 25 ft. of refrigerant piping.  
0 ft. level difference between outdoor and indoor units.

Nominal cooling capacity rating obtained with air entering the indoor unit at 80°F dry bulb (DB) and 67°F wet bulb (WB), and outdoor ambient conditions of 95°F dry bulb (DB) and 75°F wet bulb (WB).

The shaded table rows indicate reference data. When operating at this temperature, these values can be different if the system is not running consistently.

# PERFORMANCE DATA

## Cooling Capacity Tables

MULTI F  
MULTI F MAX

Table 46: LMU369HV Cooling Capacity Table — Non-Ducted Indoor Units (continued).

Connected Indoor Units	Combination Capacity Index	Outdoor Air Temp. (°F DB)	Indoor Air Temp. °F DB / °F WB											
			68 / 57		73 / 61		77 / 64		80 / 67		86 / 72		90 / 75	
			TC	PI	TC	PI	TC	PI	TC	PI	TC	PI	TC	PI
Three (3) Non-Ducted Indoor Units	12 + 12 + 18	14	33.33	1.70	35.40	1.76	37.47	1.83	38.96	1.85	41.61	1.88	43.68	1.92
		20	33.30	1.73	35.37	1.79	37.44	1.86	38.94	1.88	41.58	1.91	43.65	1.95
		25	33.28	1.75	35.35	1.82	37.41	1.88	38.91	1.90	41.55	1.94	43.61	1.98
		30	33.25	1.78	35.32	1.84	37.38	1.91	38.88	1.93	41.51	1.97	43.58	2.01
		35	33.23	1.80	35.29	1.87	37.36	1.93	38.85	1.96	41.48	1.99	43.55	2.03
		40	33.20	1.82	35.27	1.89	37.33	1.96	38.82	1.98	41.45	2.02	43.51	2.06
		45	33.18	1.85	35.24	1.92	37.30	1.99	38.79	2.01	41.42	2.05	43.48	2.09
		50	33.15	1.87	35.21	1.94	37.27	2.01	38.76	2.04	41.39	2.07	43.45	2.12
		55	33.13	1.90	35.18	1.97	37.24	2.04	38.73	2.06	41.36	2.10	43.41	2.14
		60	33.10	1.92	35.16	1.99	37.21	2.07	38.70	2.09	41.32	2.13	43.38	2.17
		65	33.08	1.95	35.13	2.02	37.18	2.09	38.67	2.12	41.29	2.16	43.35	2.20
		70	33.05	1.97	35.10	2.04	37.16	2.12	38.64	2.14	41.26	2.18	43.31	2.23
		75	32.26	2.08	34.30	2.15	36.35	2.23	37.83	2.26	40.45	2.30	42.49	2.35
		80	31.46	2.18	33.50	2.26	35.54	2.35	37.02	2.37	39.63	2.42	41.67	2.47
		85	30.67	2.29	32.71	2.37	34.75	2.46	36.22	2.49	38.82	2.54	40.86	2.59
		90	29.88	2.40	31.92	2.48	33.95	2.57	35.42	2.60	38.01	2.65	40.05	2.71
		95	29.03	2.50	31.05	2.59	33.07	2.69	<b>34.00</b>	<b>2.72</b>	37.12	2.77	39.14	2.83
		100	28.32	2.61	30.34	2.70	32.37	2.80	33.56	2.84	36.41	2.89	38.43	2.95
		105	27.61	2.72	29.64	2.81	31.66	2.92	33.12	2.95	35.70	3.01	37.73	3.07
		110	26.91	2.82	28.93	2.92	30.95	3.03	32.41	3.07	35.00	3.12	37.02	3.19
		115	26.20	2.93	28.22	3.04	30.24	3.15	31.71	3.18	34.29	3.24	36.31	3.31
	118	25.78	2.99	27.80	3.10	29.82	3.21	31.28	3.25	33.87	3.31	35.89	3.38	
	122	25.63	3.08	27.66	3.19	29.68	3.31	31.14	3.34	33.72	3.41	35.75	3.48	
	9 + 18 + 18	14	33.33	1.70	35.40	1.76	37.47	1.83	38.96	1.85	41.61	1.88	43.68	1.92
		20	33.30	1.73	35.37	1.79	37.44	1.86	38.94	1.88	41.58	1.91	43.65	1.95
		25	33.28	1.75	35.35	1.82	37.41	1.88	38.91	1.90	41.55	1.94	43.61	1.98
		30	33.25	1.78	35.32	1.84	37.38	1.91	38.88	1.93	41.51	1.97	43.58	2.01
		35	33.23	1.80	35.29	1.87	37.36	1.93	38.85	1.96	41.48	1.99	43.55	2.03
		40	33.20	1.82	35.27	1.89	37.33	1.96	38.82	1.98	41.45	2.02	43.51	2.06
		45	33.18	1.85	35.24	1.92	37.30	1.99	38.79	2.01	41.42	2.05	43.48	2.09
		50	33.15	1.87	35.21	1.94	37.27	2.01	38.76	2.04	41.39	2.07	43.45	2.12
		55	33.13	1.90	35.18	1.97	37.24	2.04	38.73	2.06	41.36	2.10	43.41	2.14
		60	33.10	1.92	35.16	1.99	37.21	2.07	38.70	2.09	41.32	2.13	43.38	2.17
		65	33.08	1.95	35.13	2.02	37.18	2.09	38.67	2.12	41.29	2.16	43.35	2.20
		70	33.05	1.97	35.10	2.04	37.16	2.12	38.64	2.14	41.26	2.18	43.31	2.23
		75	32.26	2.08	34.30	2.15	36.35	2.23	37.83	2.26	40.45	2.30	42.49	2.35
		80	31.46	2.18	33.50	2.26	35.54	2.35	37.02	2.37	39.63	2.42	41.67	2.47
		85	30.67	2.29	32.71	2.37	34.75	2.46	36.22	2.49	38.82	2.54	40.86	2.59
		90	29.88	2.40	31.92	2.48	33.95	2.57	35.42	2.60	38.01	2.65	40.05	2.71
		95	29.03	2.50	31.05	2.59	33.07	2.69	<b>34.00</b>	<b>2.72</b>	37.12	2.77	39.14	2.83
		100	28.32	2.61	30.34	2.70	32.37	2.80	33.56	2.84	36.41	2.89	38.43	2.95
		105	27.61	2.72	29.64	2.81	31.66	2.92	33.12	2.95	35.70	3.01	37.73	3.07
110		26.91	2.82	28.93	2.92	30.95	3.03	32.41	3.07	35.00	3.12	37.02	3.19	
115		26.20	2.93	28.22	3.04	30.24	3.15	31.71	3.18	34.29	3.24	36.31	3.31	
118	25.78	2.99	27.80	3.10	29.82	3.21	31.28	3.25	33.87	3.31	35.89	3.38		
122	25.63	3.08	27.66	3.19	29.68	3.31	31.14	3.34	33.72	3.41	35.75	3.48		

TC = Total Capacity (kBtu/h).

PI = Power Input (kW).

Nominal capacity as rated: 0 ft. above sea level with 25 ft. of refrigerant piping.  
0 ft. level difference between outdoor and indoor units.

Nominal cooling capacity rating obtained with air entering the indoor unit at 80°F dry bulb (DB) and 67°F wet bulb (WB), and outdoor ambient conditions of 95°F dry bulb (DB) and 75°F wet bulb (WB).

The shaded table rows indicate reference data. When operating at this temperature, these values can be different if the system is not running consistently.



Multi F and Multi F MAX Heat Pump System Engineering Manual

Table 47: LMU369HV Cooling Capacity Table — Non-Ducted Indoor Units (continued).

Connected Indoor Units	Combination Capacity Index	Outdoor Air Temp. (°F DB)	Indoor Air Temp. °F DB / °F WB											
			68 / 57		73 / 61		77 / 64		80 / 67		86 / 72		90 / 75	
			TC	PI	TC	PI	TC	PI	TC	PI	TC	PI	TC	PI
Three (3) Non-Ducted Indoor Units	12 + 18 + 18	14	33.33	1.70	35.40	1.76	37.47	1.83	38.96	1.85	41.61	1.88	43.68	1.92
		20	33.30	1.73	35.37	1.79	37.44	1.86	38.94	1.88	41.58	1.91	43.65	1.95
		25	33.28	1.75	35.35	1.82	37.41	1.88	38.91	1.90	41.55	1.94	43.61	1.98
		30	33.25	1.78	35.32	1.84	37.38	1.91	38.88	1.93	41.51	1.97	43.58	2.01
		35	33.23	1.80	35.29	1.87	37.36	1.93	38.85	1.96	41.48	1.99	43.55	2.03
		40	33.20	1.82	35.27	1.89	37.33	1.96	38.82	1.98	41.45	2.02	43.51	2.06
		45	33.18	1.85	35.24	1.92	37.30	1.99	38.79	2.01	41.42	2.05	43.48	2.09
		50	33.15	1.87	35.21	1.94	37.27	2.01	38.76	2.04	41.39	2.07	43.45	2.12
		55	33.13	1.90	35.18	1.97	37.24	2.04	38.73	2.06	41.36	2.10	43.41	2.14
		60	33.10	1.92	35.16	1.99	37.21	2.07	38.70	2.09	41.32	2.13	43.38	2.17
		65	33.08	1.95	35.13	2.02	37.18	2.09	38.67	2.12	41.29	2.16	43.35	2.20
		70	33.05	1.97	35.10	2.04	37.16	2.12	38.64	2.14	41.26	2.18	43.31	2.23
		75	32.26	2.08	34.30	2.15	36.35	2.23	37.83	2.26	40.45	2.30	42.49	2.35
		80	31.46	2.18	33.50	2.26	35.54	2.35	37.02	2.37	39.63	2.42	41.67	2.47
		85	30.67	2.29	32.71	2.37	34.75	2.46	36.22	2.49	38.82	2.54	40.86	2.59
		90	29.88	2.40	31.92	2.48	33.95	2.57	35.42	2.60	38.01	2.65	40.05	2.71
		95	29.03	2.50	31.05	2.59	33.07	2.69	<b>34.00</b>	<b>2.72</b>	37.12	2.77	39.14	2.83
		100	28.32	2.61	30.34	2.70	32.37	2.80	33.56	2.84	36.41	2.89	38.43	2.95
		105	27.61	2.72	29.64	2.81	31.66	2.92	33.12	2.95	35.70	3.01	37.73	3.07
		110	26.91	2.82	28.93	2.92	30.95	3.03	32.41	3.07	35.00	3.12	37.02	3.19
115	26.20	2.93	28.22	3.04	30.24	3.15	31.71	3.18	34.29	3.24	36.31	3.31		
118	25.78	2.99	27.80	3.10	29.82	3.21	31.28	3.25	33.87	3.31	35.89	3.38		
		122	25.63	3.08	27.66	3.19	29.68	3.31	31.14	3.34	33.72	3.41	35.75	3.48
Four (4) Non-Ducted Indoor Units	9 + 9 + 9 + 9	14	33.33	1.70	35.40	1.76	37.47	1.83	38.96	1.85	41.61	1.88	43.68	1.92
		20	33.30	1.73	35.37	1.79	37.44	1.86	38.94	1.88	41.58	1.91	43.65	1.95
		25	33.28	1.75	35.35	1.82	37.41	1.88	38.91	1.90	41.55	1.94	43.61	1.98
		30	33.25	1.78	35.32	1.84	37.38	1.91	38.88	1.93	41.51	1.97	43.58	2.01
		35	33.23	1.80	35.29	1.87	37.36	1.93	38.85	1.96	41.48	1.99	43.55	2.03
		40	33.20	1.82	35.27	1.89	37.33	1.96	38.82	1.98	41.45	2.02	43.51	2.06
		45	33.18	1.85	35.24	1.92	37.30	1.99	38.79	2.01	41.42	2.05	43.48	2.09
		50	33.15	1.87	35.21	1.94	37.27	2.01	38.76	2.04	41.39	2.07	43.45	2.12
		55	33.13	1.90	35.18	1.97	37.24	2.04	38.73	2.06	41.36	2.10	43.41	2.14
		60	33.10	1.92	35.16	1.99	37.21	2.07	38.70	2.09	41.32	2.13	43.38	2.17
		65	33.08	1.95	35.13	2.02	37.18	2.09	38.67	2.12	41.29	2.16	43.35	2.20
		70	33.05	1.97	35.10	2.04	37.16	2.12	38.64	2.14	41.26	2.18	43.31	2.23
		75	32.26	2.08	34.30	2.15	36.35	2.23	37.83	2.26	40.45	2.30	42.49	2.35
		80	31.46	2.18	33.50	2.26	35.54	2.35	37.02	2.37	39.63	2.42	41.67	2.47
		85	30.67	2.29	32.71	2.37	34.75	2.46	36.22	2.49	38.82	2.54	40.86	2.59
		90	29.88	2.40	31.92	2.48	33.95	2.57	35.42	2.60	38.01	2.65	40.05	2.71
		95	29.03	2.50	31.05	2.59	33.07	2.69	<b>34.00</b>	<b>2.72</b>	37.12	2.77	39.14	2.83
		100	28.32	2.61	30.34	2.70	32.37	2.80	33.56	2.84	36.41	2.89	38.43	2.95
		105	27.61	2.72	29.64	2.81	31.66	2.92	33.12	2.95	35.70	3.01	37.73	3.07
		110	26.91	2.82	28.93	2.92	30.95	3.03	32.41	3.07	35.00	3.12	37.02	3.19
115	26.20	2.93	28.22	3.04	30.24	3.15	31.71	3.18	34.29	3.24	36.31	3.31		
118	25.78	2.99	27.80	3.10	29.82	3.21	31.28	3.25	33.87	3.31	35.89	3.38		
		122	25.63	3.08	27.66	3.19	29.68	3.31	31.14	3.34	33.72	3.41	35.75	3.48

TC = Total Capacity (kBtu/h).

PI = Power Input (kW).

Nominal capacity as rated: 0 ft. above sea level with 25 ft. of refrigerant piping.  
0 ft. level difference between outdoor and indoor units.

Nominal cooling capacity rating obtained with air entering the indoor unit at 80°F dry bulb (DB) and 67°F wet bulb (WB), and outdoor ambient conditions of 95°F dry bulb (DB) and 75°F wet bulb (WB).

The shaded table rows indicate reference data. When operating at this temperature, these values can be different if the system is not running consistently.

# PERFORMANCE DATA

## Cooling Capacity Tables

MULTI F  
MULTI F MAX

Table 48: LMU369HV Cooling Capacity Table — Non-Ducted Indoor Units (continued).

Connected Indoor Units	Combination Capacity Index	Outdoor Air Temp. (°F DB)	Indoor Air Temp. °F DB / °F WB											
			68 / 57		73 / 61		77 / 64		80 / 67		86 / 72		90 / 75	
			TC	PI	TC	PI	TC	PI	TC	PI	TC	PI	TC	PI
Four (4) Non-Ducted Indoor Units	9 + 9 + 9 + 12	14	33.33	1.70	35.40	1.76	37.47	1.83	38.96	1.85	41.61	1.88	43.68	1.92
		20	33.30	1.73	35.37	1.79	37.44	1.86	38.94	1.88	41.58	1.91	43.65	1.95
		25	33.28	1.75	35.35	1.82	37.41	1.88	38.91	1.90	41.55	1.94	43.61	1.98
		30	33.25	1.78	35.32	1.84	37.38	1.91	38.88	1.93	41.51	1.97	43.58	2.01
		35	33.23	1.80	35.29	1.87	37.36	1.93	38.85	1.96	41.48	1.99	43.55	2.03
		40	33.20	1.82	35.27	1.89	37.33	1.96	38.82	1.98	41.45	2.02	43.51	2.06
		45	33.18	1.85	35.24	1.92	37.30	1.99	38.79	2.01	41.42	2.05	43.48	2.09
		50	33.15	1.87	35.21	1.94	37.27	2.01	38.76	2.04	41.39	2.07	43.45	2.12
		55	33.13	1.90	35.18	1.97	37.24	2.04	38.73	2.06	41.36	2.10	43.41	2.14
		60	33.10	1.92	35.16	1.99	37.21	2.07	38.70	2.09	41.32	2.13	43.38	2.17
		65	33.08	1.95	35.13	2.02	37.18	2.09	38.67	2.12	41.29	2.16	43.35	2.20
		70	33.05	1.97	35.10	2.04	37.16	2.12	38.64	2.14	41.26	2.18	43.31	2.23
		75	32.26	2.08	34.30	2.15	36.35	2.23	37.83	2.26	40.45	2.30	42.49	2.35
		80	31.46	2.18	33.50	2.26	35.54	2.35	37.02	2.37	39.63	2.42	41.67	2.47
		85	30.67	2.29	32.71	2.37	34.75	2.46	36.22	2.49	38.82	2.54	40.86	2.59
		90	29.88	2.40	31.92	2.48	33.95	2.57	35.42	2.60	38.01	2.65	40.05	2.71
		95	29.03	2.50	31.05	2.59	33.07	2.69	<b>34.00</b>	<b>2.72</b>	37.12	2.77	39.14	2.83
		100	28.32	2.61	30.34	2.70	32.37	2.80	33.56	2.84	36.41	2.89	38.43	2.95
		105	27.61	2.72	29.64	2.81	31.66	2.92	33.12	2.95	35.70	3.01	37.73	3.07
		110	26.91	2.82	28.93	2.92	30.95	3.03	32.41	3.07	35.00	3.12	37.02	3.19
		115	26.20	2.93	28.22	3.04	30.24	3.15	31.71	3.18	34.29	3.24	36.31	3.31
	118	25.78	2.99	27.80	3.10	29.82	3.21	31.28	3.25	33.87	3.31	35.89	3.38	
	122	25.63	3.08	27.66	3.19	29.68	3.31	31.14	3.34	33.72	3.41	35.75	3.48	
	9 + 9 + 12 + 12	14	33.33	1.70	35.40	1.76	37.47	1.83	38.96	1.85	41.61	1.88	43.68	1.92
		20	33.30	1.73	35.37	1.79	37.44	1.86	38.94	1.88	41.58	1.91	43.65	1.95
		25	33.28	1.75	35.35	1.82	37.41	1.88	38.91	1.90	41.55	1.94	43.61	1.98
		30	33.25	1.78	35.32	1.84	37.38	1.91	38.88	1.93	41.51	1.97	43.58	2.01
		35	33.23	1.80	35.29	1.87	37.36	1.93	38.85	1.96	41.48	1.99	43.55	2.03
		40	33.20	1.82	35.27	1.89	37.33	1.96	38.82	1.98	41.45	2.02	43.51	2.06
		45	33.18	1.85	35.24	1.92	37.30	1.99	38.79	2.01	41.42	2.05	43.48	2.09
		50	33.15	1.87	35.21	1.94	37.27	2.01	38.76	2.04	41.39	2.07	43.45	2.12
		55	33.13	1.90	35.18	1.97	37.24	2.04	38.73	2.06	41.36	2.10	43.41	2.14
		60	33.10	1.92	35.16	1.99	37.21	2.07	38.70	2.09	41.32	2.13	43.38	2.17
		65	33.08	1.95	35.13	2.02	37.18	2.09	38.67	2.12	41.29	2.16	43.35	2.20
		70	33.05	1.97	35.10	2.04	37.16	2.12	38.64	2.14	41.26	2.18	43.31	2.23
		75	32.26	2.08	34.30	2.15	36.35	2.23	37.83	2.26	40.45	2.30	42.49	2.35
		80	31.46	2.18	33.50	2.26	35.54	2.35	37.02	2.37	39.63	2.42	41.67	2.47
		85	30.67	2.29	32.71	2.37	34.75	2.46	36.22	2.49	38.82	2.54	40.86	2.59
		90	29.88	2.40	31.92	2.48	33.95	2.57	35.42	2.60	38.01	2.65	40.05	2.71
		95	29.03	2.50	31.05	2.59	33.07	2.69	<b>34.00</b>	<b>2.72</b>	37.12	2.77	39.14	2.83
		100	28.32	2.61	30.34	2.70	32.37	2.80	33.56	2.84	36.41	2.89	38.43	2.95
		105	27.61	2.72	29.64	2.81	31.66	2.92	33.12	2.95	35.70	3.01	37.73	3.07
110		26.91	2.82	28.93	2.92	30.95	3.03	32.41	3.07	35.00	3.12	37.02	3.19	
115		26.20	2.93	28.22	3.04	30.24	3.15	31.71	3.18	34.29	3.24	36.31	3.31	
118	25.78	2.99	27.80	3.10	29.82	3.21	31.28	3.25	33.87	3.31	35.89	3.38		
122	25.63	3.08	27.66	3.19	29.68	3.31	31.14	3.34	33.72	3.41	35.75	3.48		

TC = Total Capacity (kBtu/h).

PI = Power Input (kW).

Nominal capacity as rated: 0 ft. above sea level with 25 ft. of refrigerant piping.  
0 ft. level difference between outdoor and indoor units.

Nominal cooling capacity rating obtained with air entering the indoor unit at 80°F dry bulb (DB) and 67°F wet bulb (WB), and outdoor ambient conditions of 95°F dry bulb (DB) and 75°F wet bulb (WB).

The shaded table rows indicate reference data. When operating at this temperature, these values can be different if the system is not running consistently.



Multi F and Multi F MAX Heat Pump System Engineering Manual

Table 49: LMU369HV Cooling Capacity Table — Non-Ducted Indoor Units (continued).

Connected Indoor Units	Combination Capacity Index	Outdoor Air Temp. (°F DB)	Indoor Air Temp. °F DB / °F WB											
			68 / 57		73 / 61		77 / 64		80 / 67		86 / 72		90 / 75	
			TC	PI	TC	PI	TC	PI	TC	PI	TC	PI	TC	PI
Four (4) Non-Ducted Indoor Units	9 + 12 + 12 + 12	14	33.33	1.70	35.40	1.76	37.47	1.83	38.96	1.85	41.61	1.88	43.68	1.92
		20	33.30	1.73	35.37	1.79	37.44	1.86	38.94	1.88	41.58	1.91	43.65	1.95
		25	33.28	1.75	35.35	1.82	37.41	1.88	38.91	1.90	41.55	1.94	43.61	1.98
		30	33.25	1.78	35.32	1.84	37.38	1.91	38.88	1.93	41.51	1.97	43.58	2.01
		35	33.23	1.80	35.29	1.87	37.36	1.93	38.85	1.96	41.48	1.99	43.55	2.03
		40	33.20	1.82	35.27	1.89	37.33	1.96	38.82	1.98	41.45	2.02	43.51	2.06
		45	33.18	1.85	35.24	1.92	37.30	1.99	38.79	2.01	41.42	2.05	43.48	2.09
		50	33.15	1.87	35.21	1.94	37.27	2.01	38.76	2.04	41.39	2.07	43.45	2.12
		55	33.13	1.90	35.18	1.97	37.24	2.04	38.73	2.06	41.36	2.10	43.41	2.14
		60	33.10	1.92	35.16	1.99	37.21	2.07	38.70	2.09	41.32	2.13	43.38	2.17
		65	33.08	1.95	35.13	2.02	37.18	2.09	38.67	2.12	41.29	2.16	43.35	2.20
		70	33.05	1.97	35.10	2.04	37.16	2.12	38.64	2.14	41.26	2.18	43.31	2.23
		75	32.26	2.08	34.30	2.15	36.35	2.23	37.83	2.26	40.45	2.30	42.49	2.35
		80	31.46	2.18	33.50	2.26	35.54	2.35	37.02	2.37	39.63	2.42	41.67	2.47
		85	30.67	2.29	32.71	2.37	34.75	2.46	36.22	2.49	38.82	2.54	40.86	2.59
		90	29.88	2.40	31.92	2.48	33.95	2.57	35.42	2.60	38.01	2.65	40.05	2.71
		95	29.03	2.50	31.05	2.59	33.07	2.69	<b>34.00</b>	<b>2.72</b>	37.12	2.77	39.14	2.83
		100	28.32	2.61	30.34	2.70	32.37	2.80	33.56	2.84	36.41	2.89	38.43	2.95
		105	27.61	2.72	29.64	2.81	31.66	2.92	33.12	2.95	35.70	3.01	37.73	3.07
		110	26.91	2.82	28.93	2.92	30.95	3.03	32.41	3.07	35.00	3.12	37.02	3.19
		115	26.20	2.93	28.22	3.04	30.24	3.15	31.71	3.18	34.29	3.24	36.31	3.31
	118	25.78	2.99	27.80	3.10	29.82	3.21	31.28	3.25	33.87	3.31	35.89	3.38	
	122	25.63	3.08	27.66	3.19	29.68	3.31	31.14	3.34	33.72	3.41	35.75	3.48	
	9 + 9 + 9 + 18	14	33.33	1.70	35.40	1.76	37.47	1.83	38.96	1.85	41.61	1.88	43.68	1.92
		20	33.30	1.73	35.37	1.79	37.44	1.86	38.94	1.88	41.58	1.91	43.65	1.95
		25	33.28	1.75	35.35	1.82	37.41	1.88	38.91	1.90	41.55	1.94	43.61	1.98
		30	33.25	1.78	35.32	1.84	37.38	1.91	38.88	1.93	41.51	1.97	43.58	2.01
		35	33.23	1.80	35.29	1.87	37.36	1.93	38.85	1.96	41.48	1.99	43.55	2.03
		40	33.20	1.82	35.27	1.89	37.33	1.96	38.82	1.98	41.45	2.02	43.51	2.06
		45	33.18	1.85	35.24	1.92	37.30	1.99	38.79	2.01	41.42	2.05	43.48	2.09
		50	33.15	1.87	35.21	1.94	37.27	2.01	38.76	2.04	41.39	2.07	43.45	2.12
		55	33.13	1.90	35.18	1.97	37.24	2.04	38.73	2.06	41.36	2.10	43.41	2.14
		60	33.10	1.92	35.16	1.99	37.21	2.07	38.70	2.09	41.32	2.13	43.38	2.17
		65	33.08	1.95	35.13	2.02	37.18	2.09	38.67	2.12	41.29	2.16	43.35	2.20
		70	33.05	1.97	35.10	2.04	37.16	2.12	38.64	2.14	41.26	2.18	43.31	2.23
		75	32.26	2.08	34.30	2.15	36.35	2.23	37.83	2.26	40.45	2.30	42.49	2.35
		80	31.46	2.18	33.50	2.26	35.54	2.35	37.02	2.37	39.63	2.42	41.67	2.47
		85	30.67	2.29	32.71	2.37	34.75	2.46	36.22	2.49	38.82	2.54	40.86	2.59
		90	29.88	2.40	31.92	2.48	33.95	2.57	35.42	2.60	38.01	2.65	40.05	2.71
		95	29.03	2.50	31.05	2.59	33.07	2.69	<b>34.00</b>	<b>2.72</b>	37.12	2.77	39.14	2.83
		100	28.32	2.61	30.34	2.70	32.37	2.80	33.56	2.84	36.41	2.89	38.43	2.95
		105	27.61	2.72	29.64	2.81	31.66	2.92	33.12	2.95	35.70	3.01	37.73	3.07
110		26.91	2.82	28.93	2.92	30.95	3.03	32.41	3.07	35.00	3.12	37.02	3.19	
115		26.20	2.93	28.22	3.04	30.24	3.15	31.71	3.18	34.29	3.24	36.31	3.31	
118	25.78	2.99	27.80	3.10	29.82	3.21	31.28	3.25	33.87	3.31	35.89	3.38		
122	25.63	3.08	27.66	3.19	29.68	3.31	31.14	3.34	33.72	3.41	35.75	3.48		

TC = Total Capacity (kBtu/h).

PI = Power Input (kW).

Nominal capacity as rated: 0 ft. above sea level with 25 ft. of refrigerant piping.  
0 ft. level difference between outdoor and indoor units.

Nominal cooling capacity rating obtained with air entering the indoor unit at 80°F dry bulb (DB) and 67°F wet bulb (WB), and outdoor ambient conditions of 95°F dry bulb (DB) and 75°F wet bulb (WB).

The shaded table rows indicate reference data. When operating at this temperature, these values can be different if the system is not running consistently.

# PERFORMANCE DATA

## Cooling Capacity Tables

MULTI F  
MULTI F MAX

Table 50: LMU369HV Cooling Capacity Table — Non-Ducted Indoor Units (continued).

Connected Indoor Units	Combination Capacity Index	Outdoor Air Temp. (°F DB)	Indoor Air Temp. °F DB / °F WB											
			68 / 57		73 / 61		77 / 64		80 / 67		86 / 72		90 / 75	
			TC	PI	TC	PI	TC	PI	TC	PI	TC	PI	TC	PI
Four (4) Non-Ducted Indoor Units	9 + 9 + 12 + 18	14	33.33	1.70	35.40	1.76	37.47	1.83	38.96	1.85	41.61	1.88	43.68	1.92
		20	33.30	1.73	35.37	1.79	37.44	1.86	38.94	1.88	41.58	1.91	43.65	1.95
		25	33.28	1.75	35.35	1.82	37.41	1.88	38.91	1.90	41.55	1.94	43.61	1.98
		30	33.25	1.78	35.32	1.84	37.38	1.91	38.88	1.93	41.51	1.97	43.58	2.01
		35	33.23	1.80	35.29	1.87	37.36	1.93	38.85	1.96	41.48	1.99	43.55	2.03
		40	33.20	1.82	35.27	1.89	37.33	1.96	38.82	1.98	41.45	2.02	43.51	2.06
		45	33.18	1.85	35.24	1.92	37.30	1.99	38.79	2.01	41.42	2.05	43.48	2.09
		50	33.15	1.87	35.21	1.94	37.27	2.01	38.76	2.04	41.39	2.07	43.45	2.12
		55	33.13	1.90	35.18	1.97	37.24	2.04	38.73	2.06	41.36	2.10	43.41	2.14
		60	33.10	1.92	35.16	1.99	37.21	2.07	38.70	2.09	41.32	2.13	43.38	2.17
		65	33.08	1.95	35.13	2.02	37.18	2.09	38.67	2.12	41.29	2.16	43.35	2.20
		70	33.05	1.97	35.10	2.04	37.16	2.12	38.64	2.14	41.26	2.18	43.31	2.23
		75	32.26	2.08	34.30	2.15	36.35	2.23	37.83	2.26	40.45	2.30	42.49	2.35
		80	31.46	2.18	33.50	2.26	35.54	2.35	37.02	2.37	39.63	2.42	41.67	2.47
		85	30.67	2.29	32.71	2.37	34.75	2.46	36.22	2.49	38.82	2.54	40.86	2.59
		90	29.88	2.40	31.92	2.48	33.95	2.57	35.42	2.60	38.01	2.65	40.05	2.71
		95	29.03	2.50	31.05	2.59	33.07	2.69	<b>34.00</b>	<b>2.72</b>	37.12	2.77	39.14	2.83
		100	28.32	2.61	30.34	2.70	32.37	2.80	33.56	2.84	36.41	2.89	38.43	2.95
		105	27.61	2.72	29.64	2.81	31.66	2.92	33.12	2.95	35.70	3.01	37.73	3.07
		110	26.91	2.82	28.93	2.92	30.95	3.03	32.41	3.07	35.00	3.12	37.02	3.19
		115	26.20	2.93	28.22	3.04	30.24	3.15	31.71	3.18	34.29	3.24	36.31	3.31
	118	25.78	2.99	27.80	3.10	29.82	3.21	31.28	3.25	33.87	3.31	35.89	3.38	
	122	25.63	3.08	27.66	3.19	29.68	3.31	31.14	3.34	33.72	3.41	35.75	3.48	
	12 + 12 + 12 + 12	14	33.33	1.70	35.40	1.76	37.47	1.83	38.96	1.85	41.61	1.88	43.68	1.92
		20	33.30	1.73	35.37	1.79	37.44	1.86	38.94	1.88	41.58	1.91	43.65	1.95
		25	33.28	1.75	35.35	1.82	37.41	1.88	38.91	1.90	41.55	1.94	43.61	1.98
		30	33.25	1.78	35.32	1.84	37.38	1.91	38.88	1.93	41.51	1.97	43.58	2.01
		35	33.23	1.80	35.29	1.87	37.36	1.93	38.85	1.96	41.48	1.99	43.55	2.03
		40	33.20	1.82	35.27	1.89	37.33	1.96	38.82	1.98	41.45	2.02	43.51	2.06
		45	33.18	1.85	35.24	1.92	37.30	1.99	38.79	2.01	41.42	2.05	43.48	2.09
		50	33.15	1.87	35.21	1.94	37.27	2.01	38.76	2.04	41.39	2.07	43.45	2.12
		55	33.13	1.90	35.18	1.97	37.24	2.04	38.73	2.06	41.36	2.10	43.41	2.14
		60	33.10	1.92	35.16	1.99	37.21	2.07	38.70	2.09	41.32	2.13	43.38	2.17
		65	33.08	1.95	35.13	2.02	37.18	2.09	38.67	2.12	41.29	2.16	43.35	2.20
		70	33.05	1.97	35.10	2.04	37.16	2.12	38.64	2.14	41.26	2.18	43.31	2.23
		75	32.26	2.08	34.30	2.15	36.35	2.23	37.83	2.26	40.45	2.30	42.49	2.35
		80	31.46	2.18	33.50	2.26	35.54	2.35	37.02	2.37	39.63	2.42	41.67	2.47
		85	30.67	2.29	32.71	2.37	34.75	2.46	36.22	2.49	38.82	2.54	40.86	2.59
		90	29.88	2.40	31.92	2.48	33.95	2.57	35.42	2.60	38.01	2.65	40.05	2.71
		95	29.03	2.50	31.05	2.59	33.07	2.69	<b>34.00</b>	<b>2.72</b>	37.12	2.77	39.14	2.83
		100	28.32	2.61	30.34	2.70	32.37	2.80	33.56	2.84	36.41	2.89	38.43	2.95
		105	27.61	2.72	29.64	2.81	31.66	2.92	33.12	2.95	35.70	3.01	37.73	3.07
110		26.91	2.82	28.93	2.92	30.95	3.03	32.41	3.07	35.00	3.12	37.02	3.19	
115		26.20	2.93	28.22	3.04	30.24	3.15	31.71	3.18	34.29	3.24	36.31	3.31	
118	25.78	2.99	27.80	3.10	29.82	3.21	31.28	3.25	33.87	3.31	35.89	3.38		
122	25.63	3.08	27.66	3.19	29.68	3.31	31.14	3.34	33.72	3.41	35.75	3.48		

TC = Total Capacity (kBtu/h).

PI = Power Input (kW).

Nominal capacity as rated: 0 ft. above sea level with 25 ft. of refrigerant piping.  
0 ft. level difference between outdoor and indoor units.

Nominal cooling capacity rating obtained with air entering the indoor unit at 80°F dry bulb (DB) and 67°F wet bulb (WB), and outdoor ambient conditions of 95°F dry bulb (DB) and 75°F wet bulb (WB).

The shaded table rows indicate reference data. When operating at this temperature, these values can be different if the system is not running consistently.



Multi F and Multi F MAX Heat Pump System Engineering Manual

Table 51: LMU369HV Cooling Capacity Table — Ducted Indoor Units

Connected Indoor Units	Combination Capacity Index	Outdoor Air Temp. (°F DB)	Indoor Air Temp. °F DB / °F WB											
			68 / 57		73 / 61		77 / 64		80 / 67		86 / 72		90 / 75	
			TC	PI	TC	PI	TC	PI	TC	PI	TC	PI	TC	PI
Two (2) Ducted Indoor Units	9 + 9	14	17.65	1.24	18.74	1.28	19.84	1.33	20.63	1.35	22.03	1.37	23.12	1.40
		20	17.63	1.26	18.73	1.30	19.82	1.35	20.61	1.37	22.01	1.39	23.11	1.42
		25	17.62	1.27	18.71	1.32	19.81	1.37	20.60	1.39	22.00	1.41	23.09	1.44
		30	17.60	1.29	18.70	1.34	19.79	1.39	20.58	1.40	21.98	1.43	23.07	1.46
		35	17.59	1.31	18.68	1.36	19.78	1.41	20.57	1.42	21.96	1.45	23.05	1.48
		40	17.58	1.33	18.67	1.38	19.76	1.43	20.55	1.44	21.94	1.47	23.04	1.50
		45	17.56	1.35	18.66	1.40	19.75	1.45	20.53	1.46	21.93	1.49	23.02	1.52
		50	17.55	1.36	18.64	1.41	19.73	1.47	20.52	1.48	21.91	1.51	23.00	1.54
		55	17.54	1.38	18.63	1.43	19.72	1.48	20.50	1.50	21.89	1.53	22.98	1.56
		60	17.52	1.40	18.61	1.45	19.70	1.50	20.49	1.52	21.88	1.55	22.97	1.58
		65	17.51	1.42	18.60	1.47	19.69	1.52	20.47	1.54	21.86	1.57	22.95	1.60
		70	17.50	1.43	18.58	1.49	19.67	1.54	20.46	1.56	21.84	1.59	22.93	1.62
		75	17.08	1.51	18.16	1.57	19.24	1.62	20.03	1.64	21.41	1.67	22.50	1.71
		80	16.66	1.59	17.74	1.65	18.82	1.71	19.60	1.73	20.98	1.76	22.06	1.80
		85	16.24	1.67	17.32	1.73	18.40	1.79	19.17	1.81	20.55	1.85	21.63	1.88
		90	15.82	1.74	16.90	1.81	17.97	1.87	18.75	1.90	20.12	1.93	21.20	1.97
		95	15.37	1.82	16.44	1.89	17.51	1.96	<b>18.00</b>	<b>1.98</b>	19.65	2.02	20.72	2.06
		100	14.99	1.90	16.06	1.97	17.13	2.04	17.77	2.06	19.28	2.10	20.35	2.15
		105	14.62	1.98	15.69	2.05	16.76	2.12	17.53	2.15	18.90	2.19	19.97	2.23
		110	14.24	2.05	15.32	2.13	16.39	2.21	17.16	2.23	18.53	2.27	19.60	2.32
		115	13.87	2.13	14.94	2.21	16.01	2.29	16.79	2.32	18.15	2.36	19.22	2.41
		118	13.65	2.18	14.72	2.26	15.79	2.34	16.56	2.37	17.93	2.41	19.00	2.46
	122	13.57	2.24	14.64	2.32	15.71	2.41	16.49	2.43	17.85	2.48	18.92	2.53	
	14	20.59	1.38	21.86	1.43	23.14	1.48	24.07	1.50	25.70	1.52	26.98	1.55	
	20	20.57	1.40	21.85	1.45	23.13	1.50	24.05	1.52	25.68	1.55	26.96	1.58	
	25	20.55	1.42	21.83	1.47	23.11	1.52	24.03	1.54	25.66	1.57	26.94	1.60	
	30	20.54	1.44	21.81	1.49	23.09	1.54	24.01	1.56	25.64	1.59	26.92	1.62	
	35	20.52	1.46	21.80	1.51	23.07	1.56	23.99	1.58	25.62	1.61	26.90	1.64	
	40	20.51	1.48	21.78	1.53	23.05	1.59	23.97	1.60	25.60	1.63	26.88	1.67	
	45	20.49	1.50	21.76	1.55	23.04	1.61	23.96	1.63	25.58	1.66	26.86	1.69	
	50	20.48	1.52	21.75	1.57	23.02	1.63	23.94	1.65	25.56	1.68	26.83	1.71	
	55	20.46	1.54	21.73	1.59	23.00	1.65	23.92	1.67	25.54	1.70	26.81	1.73	
	60	20.44	1.55	21.71	1.61	22.98	1.67	23.90	1.69	25.52	1.72	26.79	1.76	
	65	20.43	1.57	21.70	1.63	22.97	1.69	23.88	1.71	25.50	1.74	26.77	1.78	
	70	20.41	1.59	21.68	1.65	22.95	1.71	23.86	1.73	25.48	1.77	26.75	1.80	
	75	19.92	1.68	21.19	1.74	22.45	1.81	23.36	1.83	24.98	1.86	26.25	1.90	
	80	19.43	1.77	20.69	1.83	21.95	1.90	22.87	1.92	24.48	1.96	25.74	1.99	
	85	18.94	1.85	20.20	1.92	21.46	1.99	22.37	2.01	23.98	2.05	25.24	2.09	
	90	18.46	1.94	19.71	2.01	20.97	2.08	21.87	2.11	23.48	2.15	24.73	2.19	
	95	17.93	2.02	19.18	2.10	20.43	2.17	<b>21.00</b>	<b>2.20</b>	22.93	2.24	24.17	2.29	
	100	17.49	2.11	18.74	2.19	19.99	2.27	20.73	2.29	22.49	2.34	23.74	2.38	
	105	17.06	2.20	18.30	2.28	19.55	2.36	20.46	2.39	22.05	2.43	23.30	2.48	
110	16.62	2.28	17.87	2.37	19.12	2.45	20.02	2.48	21.62	2.53	22.86	2.58		
115	16.18	2.37	17.43	2.45	18.68	2.54	19.58	2.57	21.18	2.62	22.43	2.67		
118	15.92	2.42	17.17	2.51	18.42	2.60	19.32	2.63	20.92	2.68	22.17	2.73		
122	15.83	2.49	17.08	2.58	18.33	2.67	19.23	2.70	20.83	2.76	22.08	2.81		

TC = Total Capacity (kBtu/h).

PI = Power Input (kW).

Nominal capacity as rated: 0 ft. above sea level with 25 ft. of refrigerant piping.  
0 ft. level difference between outdoor and indoor units.

Nominal cooling capacity rating obtained with air entering the indoor unit at 80°F dry bulb (DB) and 67°F wet bulb (WB), and outdoor ambient conditions of 95°F dry bulb (DB) and 75°F wet bulb (WB).

The shaded table rows indicate reference data. When operating at this temperature, these values can be different if the system is not running consistently.

# PERFORMANCE DATA

## Cooling Capacity Tables

MULTI F  
MULTI F MAX

Table 52: LMU369HV Cooling Capacity Table — Ducted Indoor Units (continued)

Connected Indoor Units	Combination Capacity Index	Outdoor Air Temp. (°F DB)	Indoor Air Temp. °F DB / °F WB											
			68 / 57		73 / 61		77 / 64		80 / 67		86 / 72		90 / 75	
			TC	PI	TC	PI	TC	PI	TC	PI	TC	PI	TC	PI
Two (2) Ducted Indoor Units	12 + 12	14	23.53	1.51	24.99	1.57	26.45	1.63	27.50	1.65	29.37	1.68	30.83	1.71
		20	23.51	1.54	24.97	1.59	26.43	1.65	27.48	1.67	29.35	1.70	30.81	1.73
		25	23.49	1.56	24.95	1.61	26.41	1.67	27.46	1.69	29.33	1.72	30.79	1.76
		30	23.47	1.58	24.93	1.64	26.39	1.70	27.44	1.72	29.30	1.75	30.76	1.78
		35	23.46	1.60	24.91	1.66	26.37	1.72	27.42	1.74	29.28	1.77	30.74	1.81
		40	23.44	1.62	24.89	1.68	26.35	1.74	27.40	1.76	29.26	1.80	30.72	1.83
		45	23.42	1.64	24.87	1.71	26.33	1.77	27.38	1.79	29.24	1.82	30.69	1.86
		50	23.40	1.67	24.85	1.73	26.31	1.79	27.36	1.81	29.21	1.85	30.67	1.88
		55	23.38	1.69	24.84	1.75	26.29	1.81	27.34	1.83	29.19	1.87	30.64	1.91
		60	23.37	1.71	24.82	1.77	26.27	1.84	27.32	1.86	29.17	1.89	30.62	1.93
		65	23.35	1.73	24.80	1.80	26.25	1.86	27.29	1.88	29.15	1.92	30.60	1.96
		70	23.33	1.75	24.78	1.82	26.23	1.88	27.27	1.91	29.13	1.94	30.57	1.98
		75	22.77	1.85	24.21	1.92	25.66	1.99	26.70	2.01	28.55	2.05	29.99	2.09
		80	22.21	1.94	23.65	2.01	25.09	2.09	26.13	2.11	27.97	2.15	29.42	2.19
		85	21.65	2.04	23.09	2.11	24.53	2.19	25.57	2.21	27.40	2.26	28.84	2.30
		90	21.09	2.13	22.53	2.21	23.96	2.29	25.00	2.32	26.83	2.36	28.27	2.41
		95	20.49	2.23	21.92	2.31	23.35	2.39	<b>24.00</b>	<b>2.42</b>	26.20	2.47	27.63	2.51
		100	19.99	2.32	21.42	2.41	22.85	2.49	23.69	2.52	25.70	2.57	27.13	2.62
		105	19.49	2.42	20.92	2.50	22.35	2.60	23.38	2.63	25.20	2.67	26.63	2.73
		110	18.99	2.51	20.42	2.60	21.85	2.70	22.88	2.73	24.70	2.78	26.13	2.84
		115	18.49	2.61	19.92	2.70	21.35	2.80	22.38	2.83	24.20	2.88	25.63	2.94
	118	18.19	2.66	19.62	2.76	21.05	2.86	22.08	2.89	23.90	2.95	25.33	3.01	
	122	18.10	2.74	19.52	2.84	20.95	2.94	21.98	2.98	23.81	3.03	25.23	3.09	
	9 + 18	14	26.47	1.58	28.11	1.64	29.76	1.70	30.94	1.72	33.04	1.75	34.69	1.79
		20	26.45	1.61	28.09	1.66	29.73	1.73	30.92	1.75	33.02	1.78	34.66	1.81
		25	26.43	1.63	28.07	1.69	29.71	1.75	30.90	1.77	32.99	1.80	34.63	1.84
		30	26.41	1.65	28.05	1.71	29.69	1.77	30.87	1.79	32.97	1.83	34.61	1.87
		35	26.39	1.67	28.03	1.74	29.66	1.80	30.85	1.82	32.94	1.85	34.58	1.89
		40	26.37	1.70	28.00	1.76	29.64	1.82	30.82	1.84	32.92	1.88	34.55	1.92
		45	26.35	1.72	27.98	1.78	29.62	1.85	30.80	1.87	32.89	1.90	34.53	1.94
		50	26.33	1.74	27.96	1.81	29.60	1.87	30.78	1.89	32.87	1.93	34.50	1.97
		55	26.31	1.77	27.94	1.83	29.57	1.90	30.75	1.92	32.84	1.95	34.48	1.99
		60	26.29	1.79	27.92	1.85	29.55	1.92	30.73	1.94	32.82	1.98	34.45	2.02
		65	26.27	1.81	27.90	1.88	29.53	1.95	30.71	1.97	32.79	2.00	34.42	2.04
		70	26.25	1.83	27.88	1.90	29.51	1.97	30.68	1.99	32.77	2.03	34.40	2.07
		75	25.61	1.93	27.24	2.00	28.87	2.08	30.04	2.10	32.12	2.14	33.74	2.18
		80	24.98	2.03	26.60	2.11	28.23	2.18	29.40	2.21	31.47	2.25	33.09	2.29
		85	24.36	2.13	25.97	2.21	27.59	2.29	28.76	2.32	30.83	2.36	32.45	2.41
		90	23.73	2.23	25.34	2.31	26.96	2.39	28.12	2.42	30.19	2.47	31.80	2.52
		95	23.05	2.33	24.66	2.41	26.26	2.50	<b>27.00</b>	<b>2.53</b>	29.48	2.58	31.08	2.63
		100	22.49	2.43	24.10	2.52	25.70	2.61	26.65	2.64	28.91	2.69	30.52	2.74
		105	21.93	2.53	23.53	2.62	25.14	2.71	26.30	2.74	28.35	2.80	29.96	2.85
110		21.37	2.62	22.97	2.72	24.58	2.82	25.74	2.85	27.79	2.91	29.40	2.96	
115		20.81	2.72	22.41	2.82	24.02	2.93	25.18	2.96	27.23	3.02	28.84	3.08	
118	20.47	2.78	22.08	2.88	23.68	2.99	24.84	3.02	26.89	3.08	28.50	3.14		
122	20.36	2.86	21.96	2.97	23.57	3.08	24.73	3.11	26.78	3.17	28.39	3.23		

TC = Total Capacity (kBtu/h).

PI = Power Input (kW).

Nominal capacity as rated: 0 ft. above sea level with 25 ft. of refrigerant piping.  
0 ft. level difference between outdoor and indoor units.

Nominal cooling capacity rating obtained with air entering the indoor unit at 80°F dry bulb (DB) and 67°F wet bulb (WB), and outdoor ambient conditions of 95°F dry bulb (DB) and 75°F wet bulb (WB).

The shaded table rows indicate reference data. When operating at this temperature, these values can be different if the system is not running consistently.

Multi F and Multi F MAX Heat Pump System Engineering Manual

Table 53: LMU369HV Cooling Capacity Table — Ducted Indoor Units (continued)

Connected Indoor Units	Combination Capacity Index	Outdoor Air Temp. (°F DB)	Indoor Air Temp. °F DB / °F WB											
			68 / 57		73 / 61		77 / 64		80 / 67		86 / 72		90 / 75	
			TC	PI	TC	PI	TC	PI	TC	PI	TC	PI	TC	PI
Two (2) Ducted Indoor Units	12 + 18	14	29.41	1.70	31.24	1.76	33.06	1.82	34.38	1.84	36.71	1.88	38.54	1.92
		20	29.39	1.72	31.21	1.78	33.04	1.85	34.35	1.87	36.69	1.90	38.51	1.94
		25	29.36	1.74	31.19	1.81	33.01	1.87	34.33	1.90	36.66	1.93	38.48	1.97
		30	29.34	1.77	31.16	1.83	32.99	1.90	34.30	1.92	36.63	1.96	38.45	2.00
		35	29.32	1.79	31.14	1.86	32.96	1.93	34.28	1.95	36.60	1.99	38.42	2.03
		40	29.30	1.82	31.12	1.88	32.94	1.95	34.25	1.98	36.57	2.01	38.39	2.05
		45	29.27	1.84	31.09	1.91	32.91	1.98	34.22	2.00	36.55	2.04	38.36	2.08
		50	29.25	1.87	31.07	1.93	32.89	2.01	34.20	2.03	36.52	2.07	38.34	2.11
		55	29.23	1.89	31.04	1.96	32.86	2.03	34.17	2.05	36.49	2.09	38.31	2.14
		60	29.21	1.92	31.02	1.99	32.83	2.06	34.14	2.08	36.46	2.12	38.28	2.16
		65	29.18	1.94	31.00	2.01	32.81	2.08	34.12	2.11	36.43	2.15	38.25	2.19
		70	29.16	1.96	30.97	2.04	32.78	2.11	34.09	2.13	36.41	2.17	38.22	2.22
		75	28.46	2.07	30.27	2.15	32.07	2.22	33.38	2.25	35.69	2.29	37.49	2.34
		80	27.76	2.18	29.56	2.26	31.36	2.34	32.66	2.36	34.97	2.41	36.77	2.46
		85	27.06	2.28	28.86	2.37	30.66	2.45	31.96	2.48	34.25	2.53	36.05	2.58
		90	26.37	2.39	28.16	2.47	29.95	2.57	31.25	2.59	33.54	2.64	35.33	2.70
		95	25.61	2.49	27.40	2.58	29.18	2.68	<b>30.00</b>	<b>2.71</b>	32.75	2.76	34.53	2.82
		100	24.99	2.60	26.77	2.69	28.56	2.79	29.61	2.83	32.13	2.88	33.91	2.94
	105	24.37	2.71	26.15	2.80	27.93	2.91	29.22	2.94	31.50	3.00	33.29	3.06	
	110	23.74	2.81	25.53	2.91	27.31	3.02	28.60	3.06	30.88	3.11	32.66	3.18	
	115	23.12	2.92	24.90	3.02	26.69	3.13	27.98	3.17	30.26	3.23	32.04	3.29	
	118	22.74	2.98	24.53	3.09	26.31	3.20	27.60	3.24	29.88	3.30	31.67	3.37	
	122	22.62	3.07	24.40	3.18	26.19	3.29	27.48	3.33	29.76	3.39	31.54	3.46	
	14	32.35	1.88	34.36	1.95	36.37	2.02	37.82	2.04	40.39	2.08	42.40	2.12	
	20	32.33	1.90	34.33	1.97	36.34	2.05	37.79	2.07	40.36	2.11	42.36	2.15	
	25	32.30	1.93	34.31	2.00	36.31	2.07	37.76	2.10	40.32	2.14	42.33	2.18	
	30	32.28	1.96	34.28	2.03	36.28	2.10	37.73	2.13	40.29	2.17	42.30	2.21	
	35	32.25	1.99	34.25	2.06	36.26	2.13	37.70	2.16	40.26	2.20	42.27	2.24	
	40	32.23	2.01	34.23	2.09	36.23	2.16	37.67	2.19	40.23	2.23	42.23	2.27	
	45	32.20	2.04	34.20	2.11	36.20	2.19	37.65	2.22	40.20	2.26	42.20	2.30	
	50	32.18	2.07	34.18	2.14	36.17	2.22	37.62	2.25	40.17	2.29	42.17	2.33	
	55	32.15	2.09	34.15	2.17	36.15	2.25	37.59	2.27	40.14	2.32	42.14	2.36	
	60	32.13	2.12	34.12	2.20	36.12	2.28	37.56	2.30	40.11	2.35	42.10	2.39	
	65	32.10	2.15	34.10	2.23	36.09	2.31	37.53	2.33	40.08	2.38	42.07	2.42	
	70	32.08	2.17	34.07	2.25	36.06	2.34	37.50	2.36	40.05	2.41	42.04	2.46	
	75	31.31	2.29	33.29	2.38	35.28	2.46	36.72	2.49	39.26	2.54	41.24	2.59	
	80	30.53	2.41	32.52	2.50	34.50	2.59	35.93	2.62	38.46	2.67	40.45	2.72	
	85	29.77	2.53	31.75	2.62	33.72	2.71	35.15	2.75	37.68	2.80	39.66	2.85	
	90	29.00	2.64	30.98	2.74	32.95	2.84	34.37	2.87	36.89	2.93	38.87	2.99	
	95	28.17	2.76	30.14	2.86	32.10	2.97	<b>33.00</b>	<b>3.00</b>	36.03	3.06	37.99	3.12	
	100	27.49	2.88	29.45	2.98	31.41	3.09	32.57	3.13	35.34	3.19	37.30	3.25	
	105	26.80	3.00	28.76	3.10	30.73	3.22	32.14	3.25	34.65	3.32	36.62	3.38	
110	26.12	3.11	28.08	3.23	30.04	3.34	31.46	3.38	33.97	3.45	35.93	3.52		
115	25.43	3.23	27.39	3.35	29.36	3.47	30.77	3.51	33.28	3.58	35.24	3.65		
118	25.02	3.30	26.98	3.42	28.94	3.55	30.36	3.59	32.87	3.65	34.83	3.73		
122	24.88	3.39	26.84	3.52	28.81	3.65	30.22	3.69	32.73	3.76	34.69	3.83		

TC = Total Capacity (kBtu/h).

PI = Power Input (kW).

Nominal capacity as rated: 0 ft. above sea level with 25 ft. of refrigerant piping.  
0 ft. level difference between outdoor and indoor units.

Nominal cooling capacity rating obtained with air entering the indoor unit at 80°F dry bulb (DB) and 67°F wet bulb (WB), and outdoor ambient conditions of 95°F dry bulb (DB) and 75°F wet bulb (WB).

The shaded table rows indicate reference data. When operating at this temperature, these values can be different if the system is not running consistently.

# PERFORMANCE DATA

## Cooling Capacity Tables

MULTI F  
MULTI F MAX

Table 54: LMU369HV Cooling Capacity Table — Ducted Indoor Units (continued).

Connected Indoor Units	Combination Capacity Index	Outdoor Air Temp. (°F DB)	Indoor Air Temp. °F DB / °F WB											
			68 / 57		73 / 61		77 / 64		80 / 67		86 / 72		90 / 75	
			TC	PI	TC	PI	TC	PI	TC	PI	TC	PI	TC	PI
Two (2) Ducted Indoor Units	24 + 9	14	32.35	1.88	34.36	1.95	36.37	2.02	37.82	2.04	40.39	2.08	42.40	2.12
		20	32.33	1.90	34.33	1.97	36.34	2.05	37.79	2.07	40.36	2.11	42.36	2.15
		25	32.30	1.93	34.31	2.00	36.31	2.07	37.76	2.10	40.32	2.14	42.33	2.18
		30	32.28	1.96	34.28	2.03	36.28	2.10	37.73	2.13	40.29	2.17	42.30	2.21
		35	32.25	1.99	34.25	2.06	36.26	2.13	37.70	2.16	40.26	2.20	42.27	2.24
		40	32.23	2.01	34.23	2.09	36.23	2.16	37.67	2.19	40.23	2.23	42.23	2.27
		45	32.20	2.04	34.20	2.11	36.20	2.19	37.65	2.22	40.20	2.26	42.20	2.30
		50	32.18	2.07	34.18	2.14	36.17	2.22	37.62	2.25	40.17	2.29	42.17	2.33
		55	32.15	2.09	34.15	2.17	36.15	2.25	37.59	2.27	40.14	2.32	42.14	2.36
		60	32.13	2.12	34.12	2.20	36.12	2.28	37.56	2.30	40.11	2.35	42.10	2.39
		65	32.10	2.15	34.10	2.23	36.09	2.31	37.53	2.33	40.08	2.38	42.07	2.42
		70	32.08	2.17	34.07	2.25	36.06	2.34	37.50	2.36	40.05	2.41	42.04	2.46
		75	31.31	2.29	33.29	2.38	35.28	2.46	36.72	2.49	39.26	2.54	41.24	2.59
		80	30.53	2.41	32.52	2.50	34.50	2.59	35.93	2.62	38.46	2.67	40.45	2.72
		85	29.77	2.53	31.75	2.62	33.72	2.71	35.15	2.75	37.68	2.80	39.66	2.85
		90	29.00	2.64	30.98	2.74	32.95	2.84	34.37	2.87	36.89	2.93	38.87	2.99
		95	28.17	2.76	30.14	2.86	32.10	2.97	<b>33.00</b>	<b>3.00</b>	36.03	3.06	37.99	3.12
		100	27.49	2.88	29.45	2.98	31.41	3.09	32.57	3.13	35.34	3.19	37.30	3.25
		105	26.80	3.00	28.76	3.10	30.73	3.22	32.14	3.25	34.65	3.32	36.62	3.38
		110	26.12	3.11	28.08	3.23	30.04	3.34	31.46	3.38	33.97	3.45	35.93	3.52
		115	25.43	3.23	27.39	3.35	29.36	3.47	30.77	3.51	33.28	3.58	35.24	3.65
	118	25.02	3.30	26.98	3.42	28.94	3.55	30.36	3.59	32.87	3.65	34.83	3.73	
	122	24.88	3.39	26.84	3.52	28.81	3.65	30.22	3.69	32.73	3.76	34.69	3.83	
	24 + 12	14	32.35	1.88	34.36	1.95	36.37	2.02	37.82	2.04	40.39	2.08	42.40	2.12
		20	32.33	1.90	34.33	1.97	36.34	2.05	37.79	2.07	40.36	2.11	42.36	2.15
		25	32.30	1.93	34.31	2.00	36.31	2.07	37.76	2.10	40.32	2.14	42.33	2.18
		30	32.28	1.96	34.28	2.03	36.28	2.10	37.73	2.13	40.29	2.17	42.30	2.21
		35	32.25	1.99	34.25	2.06	36.26	2.13	37.70	2.16	40.26	2.20	42.27	2.24
		40	32.23	2.01	34.23	2.09	36.23	2.16	37.67	2.19	40.23	2.23	42.23	2.27
		45	32.20	2.04	34.20	2.11	36.20	2.19	37.65	2.22	40.20	2.26	42.20	2.30
		50	32.18	2.07	34.18	2.14	36.17	2.22	37.62	2.25	40.17	2.29	42.17	2.33
		55	32.15	2.09	34.15	2.17	36.15	2.25	37.59	2.27	40.14	2.32	42.14	2.36
		60	32.13	2.12	34.12	2.20	36.12	2.28	37.56	2.30	40.11	2.35	42.10	2.39
		65	32.10	2.15	34.10	2.23	36.09	2.31	37.53	2.33	40.08	2.38	42.07	2.42
		70	32.08	2.17	34.07	2.25	36.06	2.34	37.50	2.36	40.05	2.41	42.04	2.46
		75	31.31	2.29	33.29	2.38	35.28	2.46	36.72	2.49	39.26	2.54	41.24	2.59
		80	30.53	2.41	32.52	2.50	34.50	2.59	35.93	2.62	38.46	2.67	40.45	2.72
		85	29.77	2.53	31.75	2.62	33.72	2.71	35.15	2.75	37.68	2.80	39.66	2.85
		90	29.00	2.64	30.98	2.74	32.95	2.84	34.37	2.87	36.89	2.93	38.87	2.99
		95	28.17	2.76	30.14	2.86	32.10	2.97	<b>33.00</b>	<b>3.00</b>	36.03	3.06	37.99	3.12
		100	27.49	2.88	29.45	2.98	31.41	3.09	32.57	3.13	35.34	3.19	37.30	3.25
		105	26.80	3.00	28.76	3.10	30.73	3.22	32.14	3.25	34.65	3.32	36.62	3.38
110		26.12	3.11	28.08	3.23	30.04	3.34	31.46	3.38	33.97	3.45	35.93	3.52	
115		25.43	3.23	27.39	3.35	29.36	3.47	30.77	3.51	33.28	3.58	35.24	3.65	
118	25.02	3.30	26.98	3.42	28.94	3.55	30.36	3.59	32.87	3.65	34.83	3.73		
122	24.88	3.39	26.84	3.52	28.81	3.65	30.22	3.69	32.73	3.76	34.69	3.83		

TC = Total Capacity (kBtu/h).

PI = Power Input (kW).

Nominal capacity as rated: 0 ft. above sea level with 25 ft. of refrigerant piping.  
0 ft. level difference between outdoor and indoor units.

Nominal cooling capacity rating obtained with air entering the indoor unit at 80°F dry bulb (DB) and 67°F wet bulb (WB), and outdoor ambient conditions of 95°F dry bulb (DB) and 75°F wet bulb (WB).

The shaded table rows indicate reference data. When operating at this temperature, these values can be different if the system is not running consistently.

Multi F and Multi F MAX Heat Pump System Engineering Manual

Table 55: LMU369HV Cooling Capacity Table — Ducted Indoor Units (continued).

Connected Indoor Units	Combination Capacity Index	Outdoor Air Temp. (°F DB)	Indoor Air Temp. °F DB / °F WB											
			68 / 57		73 / 61		77 / 64		80 / 67		86 / 72		90 / 75	
			TC	PI	TC	PI	TC	PI	TC	PI	TC	PI	TC	PI
Three (3) Ducted Indoor Units	9 + 9 + 9	14	26.47	1.58	28.11	1.64	29.76	1.70	30.94	1.72	33.04	1.75	34.69	1.79
		20	26.45	1.61	28.09	1.66	29.73	1.73	30.92	1.75	33.02	1.78	34.66	1.81
		25	26.43	1.63	28.07	1.69	29.71	1.75	30.90	1.77	32.99	1.80	34.63	1.84
		30	26.41	1.65	28.05	1.71	29.69	1.77	30.87	1.79	32.97	1.83	34.61	1.87
		35	26.39	1.67	28.03	1.74	29.66	1.80	30.85	1.82	32.94	1.85	34.58	1.89
		40	26.37	1.70	28.00	1.76	29.64	1.82	30.82	1.84	32.92	1.88	34.55	1.92
		45	26.35	1.72	27.98	1.78	29.62	1.85	30.80	1.87	32.89	1.90	34.53	1.94
		50	26.33	1.74	27.96	1.81	29.60	1.87	30.78	1.89	32.87	1.93	34.50	1.97
		55	26.31	1.77	27.94	1.83	29.57	1.90	30.75	1.92	32.84	1.95	34.48	1.99
		60	26.29	1.79	27.92	1.85	29.55	1.92	30.73	1.94	32.82	1.98	34.45	2.02
		65	26.27	1.81	27.90	1.88	29.53	1.95	30.71	1.97	32.79	2.00	34.42	2.04
		70	26.25	1.83	27.88	1.90	29.51	1.97	30.68	1.99	32.77	2.03	34.40	2.07
		75	25.61	1.93	27.24	2.00	28.87	2.08	30.04	2.10	32.12	2.14	33.74	2.18
		80	24.98	2.03	26.60	2.11	28.23	2.18	29.40	2.21	31.47	2.25	33.09	2.29
		85	24.36	2.13	25.97	2.21	27.59	2.29	28.76	2.32	30.83	2.36	32.45	2.41
		90	23.73	2.23	25.34	2.31	26.96	2.39	28.12	2.42	30.19	2.47	31.80	2.52
		95	23.05	2.33	24.66	2.41	26.26	2.50	27.00	2.53	29.48	2.58	31.08	2.63
		100	22.49	2.43	24.10	2.52	25.70	2.61	26.65	2.64	28.91	2.69	30.52	2.74
	105	21.93	2.53	23.53	2.62	25.14	2.71	26.30	2.74	28.35	2.80	29.96	2.85	
	110	21.37	2.62	22.97	2.72	24.58	2.82	25.74	2.85	27.79	2.91	29.40	2.96	
	115	20.81	2.72	22.41	2.82	24.02	2.93	25.18	2.96	27.23	3.02	28.84	3.08	
	118	20.47	2.78	22.08	2.88	23.68	2.99	24.84	3.02	26.89	3.08	28.50	3.14	
	122	20.36	2.86	21.96	2.97	23.57	3.08	24.73	3.11	26.78	3.17	28.39	3.23	
	9 + 9 + 12	14	29.41	1.70	31.24	1.76	33.06	1.82	34.38	1.84	36.71	1.88	38.54	1.92
		20	29.39	1.72	31.21	1.78	33.04	1.85	34.35	1.87	36.69	1.90	38.51	1.94
		25	29.36	1.74	31.19	1.81	33.01	1.87	34.33	1.90	36.66	1.93	38.48	1.97
		30	29.34	1.77	31.16	1.83	32.99	1.90	34.30	1.92	36.63	1.96	38.45	2.00
		35	29.32	1.79	31.14	1.86	32.96	1.93	34.28	1.95	36.60	1.99	38.42	2.03
		40	29.30	1.82	31.12	1.88	32.94	1.95	34.25	1.98	36.57	2.01	38.39	2.05
		45	29.27	1.84	31.09	1.91	32.91	1.98	34.22	2.00	36.55	2.04	38.36	2.08
		50	29.25	1.87	31.07	1.93	32.89	2.01	34.20	2.03	36.52	2.07	38.34	2.11
		55	29.23	1.89	31.04	1.96	32.86	2.03	34.17	2.05	36.49	2.09	38.31	2.14
		60	29.21	1.92	31.02	1.99	32.83	2.06	34.14	2.08	36.46	2.12	38.28	2.16
		65	29.18	1.94	31.00	2.01	32.81	2.08	34.12	2.11	36.43	2.15	38.25	2.19
		70	29.16	1.96	30.97	2.04	32.78	2.11	34.09	2.13	36.41	2.17	38.22	2.22
		75	28.46	2.07	30.27	2.15	32.07	2.22	33.38	2.25	35.69	2.29	37.49	2.34
80		27.76	2.18	29.56	2.26	31.36	2.34	32.66	2.36	34.97	2.41	36.77	2.46	
85		27.06	2.28	28.86	2.37	30.66	2.45	31.96	2.48	34.25	2.53	36.05	2.58	
90		26.37	2.39	28.16	2.47	29.95	2.57	31.25	2.59	33.54	2.64	35.33	2.70	
95		25.61	2.49	27.40	2.58	29.18	2.68	30.00	2.71	32.75	2.76	34.53	2.82	
100		24.99	2.60	26.77	2.69	28.56	2.79	29.61	2.83	32.13	2.88	33.91	2.94	
105	24.37	2.71	26.15	2.80	27.93	2.91	29.22	2.94	31.50	3.00	33.29	3.06		
110	23.74	2.81	25.53	2.91	27.31	3.02	28.60	3.06	30.88	3.11	32.66	3.18		
115	23.12	2.92	24.90	3.02	26.69	3.13	27.98	3.17	30.26	3.23	32.04	3.29		
118	22.74	2.98	24.53	3.09	26.31	3.20	27.60	3.24	29.88	3.30	31.67	3.37		
122	22.62	3.07	24.40	3.18	26.19	3.29	27.48	3.33	29.76	3.39	31.54	3.46		

TC = Total Capacity (kBtu/h).

PI = Power Input (kW).

Nominal capacity as rated: 0 ft. above sea level with 25 ft. of refrigerant piping.  
0 ft. level difference between outdoor and indoor units.

Nominal cooling capacity rating obtained with air entering the indoor unit at 80°F dry bulb (DB) and 67°F wet bulb (WB), and outdoor ambient conditions of 95°F dry bulb (DB) and 75°F wet bulb (WB).

The shaded table rows indicate reference data. When operating at this temperature, these values can be different if the system is not running consistently.

# PERFORMANCE DATA

## Cooling Capacity Tables

MULTI F  
MULTI F MAX

Table 56: LMU369HV Cooling Capacity Table — Ducted Indoor Units (continued).

Connected Indoor Units	Combination Capacity Index	Outdoor Air Temp. (°F DB)	Indoor Air Temp. °F DB / °F WB											
			68 / 57		73 / 61		77 / 64		80 / 67		86 / 72		90 / 75	
			TC	PI	TC	PI	TC	PI	TC	PI	TC	PI	TC	PI
Three (3) Ducted Indoor Units	9 + 12 + 12	14	32.35	1.79	34.36	1.86	36.37	1.92	37.82	1.95	40.39	1.98	42.40	2.02
		20	32.33	1.82	34.33	1.88	36.34	1.95	37.79	1.97	40.36	2.01	42.36	2.05
		25	32.30	1.84	34.31	1.91	36.31	1.98	37.76	2.00	40.32	2.04	42.33	2.08
		30	32.28	1.87	34.28	1.94	36.28	2.01	37.73	2.03	40.29	2.07	42.30	2.11
		35	32.25	1.89	34.25	1.96	36.26	2.03	37.70	2.06	40.26	2.10	42.27	2.14
		40	32.23	1.92	34.23	1.99	36.23	2.06	37.67	2.08	40.23	2.12	42.23	2.17
		45	32.20	1.94	34.20	2.02	36.20	2.09	37.65	2.11	40.20	2.15	42.20	2.20
		50	32.18	1.97	34.18	2.04	36.17	2.12	37.62	2.14	40.17	2.18	42.17	2.22
		55	32.15	2.00	34.15	2.07	36.15	2.14	37.59	2.17	40.14	2.21	42.14	2.25
		60	32.13	2.02	34.12	2.10	36.12	2.17	37.56	2.20	40.11	2.24	42.10	2.28
		65	32.10	2.05	34.10	2.12	36.09	2.20	37.53	2.22	40.08	2.27	42.07	2.31
		70	32.08	2.07	34.07	2.15	36.06	2.23	37.50	2.25	40.05	2.29	42.04	2.34
		75	31.31	2.18	33.29	2.26	35.28	2.35	36.72	2.37	39.26	2.42	41.24	2.47
		80	30.53	2.30	32.52	2.38	34.50	2.47	35.93	2.50	38.46	2.54	40.45	2.59
		85	29.77	2.41	31.75	2.50	33.72	2.59	35.15	2.62	37.68	2.67	39.66	2.72
		90	29.00	2.52	30.98	2.61	32.95	2.71	34.37	2.74	36.89	2.79	38.87	2.85
		95	28.17	2.63	30.14	2.73	32.10	2.83	<b>33.00</b>	<b>2.86</b>	36.03	2.91	37.99	2.97
		100	27.49	2.74	29.45	2.84	31.41	2.95	32.57	2.98	35.34	3.04	37.30	3.10
	105	26.80	2.86	28.76	2.96	30.73	3.07	32.14	3.10	34.65	3.16	36.62	3.22	
	110	26.12	2.97	28.08	3.08	30.04	3.19	31.46	3.22	33.97	3.28	35.93	3.35	
	115	25.43	3.08	27.39	3.19	29.36	3.31	30.77	3.35	33.28	3.41	35.24	3.48	
	118	25.02	3.15	26.98	3.26	28.94	3.38	30.36	3.42	32.87	3.48	34.83	3.55	
	122	24.88	3.24	26.84	3.35	28.81	3.48	30.22	3.52	32.73	3.58	34.69	3.65	
	12 + 12 + 12	14	33.33	1.78	35.40	1.84	37.47	1.91	38.96	1.93	41.61	1.97	43.68	2.01
		20	33.30	1.80	35.37	1.87	37.44	1.94	38.94	1.96	41.58	2.00	43.65	2.04
		25	33.28	1.83	35.35	1.90	37.41	1.96	38.91	1.99	41.55	2.02	43.61	2.06
		30	33.25	1.85	35.32	1.92	37.38	1.99	38.88	2.01	41.51	2.05	43.58	2.09
		35	33.23	1.88	35.29	1.95	37.36	2.02	38.85	2.04	41.48	2.08	43.55	2.12
		40	33.20	1.90	35.27	1.97	37.33	2.05	38.82	2.07	41.45	2.11	43.51	2.15
		45	33.18	1.93	35.24	2.00	37.30	2.07	38.79	2.10	41.42	2.14	43.48	2.18
		50	33.15	1.96	35.21	2.03	37.27	2.10	38.76	2.13	41.39	2.17	43.45	2.21
		55	33.13	1.98	35.18	2.05	37.24	2.13	38.73	2.15	41.36	2.19	43.41	2.24
		60	33.10	2.01	35.16	2.08	37.21	2.16	38.70	2.18	41.32	2.22	43.38	2.27
		65	33.08	2.03	35.13	2.11	37.18	2.18	38.67	2.21	41.29	2.25	43.35	2.30
		70	33.05	2.06	35.10	2.13	37.16	2.21	38.64	2.24	41.26	2.28	43.31	2.32
		75	32.26	2.17	34.30	2.25	36.35	2.33	37.83	2.36	40.45	2.40	42.49	2.45
80		31.46	2.28	33.50	2.36	35.54	2.45	37.02	2.48	39.63	2.52	41.67	2.58	
85		30.67	2.39	32.71	2.48	34.75	2.57	36.22	2.60	38.82	2.65	40.86	2.70	
90		29.88	2.50	31.92	2.59	33.95	2.69	35.42	2.72	38.01	2.77	40.05	2.83	
95		29.03	2.61	31.05	2.71	33.07	2.81	<b>34.00</b>	<b>2.84</b>	37.12	2.89	39.14	2.95	
100		28.32	2.72	30.34	2.82	32.37	2.93	33.56	2.96	36.41	3.02	38.43	3.08	
105	27.61	2.84	29.64	2.94	31.66	3.05	33.12	3.08	35.70	3.14	37.73	3.20		
110	26.91	2.95	28.93	3.05	30.95	3.17	32.41	3.20	35.00	3.26	37.02	3.33		
115	26.20	3.06	28.22	3.17	30.24	3.28	31.71	3.32	34.29	3.38	36.31	3.45		
118	25.78	3.12	27.80	3.24	29.82	3.36	31.28	3.40	33.87	3.46	35.89	3.53		
122	25.63	3.21	27.66	3.33	29.68	3.45	31.14	3.49	33.72	3.56	35.75	3.63		

TC = Total Capacity (kBtu/h).

PI = Power Input (kW).

Nominal capacity as rated: 0 ft. above sea level with 25 ft. of refrigerant piping.  
0 ft. level difference between outdoor and indoor units.

Nominal cooling capacity rating obtained with air entering the indoor unit at 80°F dry bulb (DB) and 67°F wet bulb (WB), and outdoor ambient conditions of 95°F dry bulb (DB) and 75°F wet bulb (WB).

The shaded table rows indicate reference data. When operating at this temperature, these values can be different if the system is not running consistently.



Multi F and Multi F MAX Heat Pump System Engineering Manual

Table 57: LMU369HV Cooling Capacity Table — Ducted Indoor Units (continued).

Connected Indoor Units	Combination Capacity Index	Outdoor Air Temp. (°F DB)	Indoor Air Temp. °F DB / °F WB											
			68 / 57		73 / 61		77 / 64		80 / 67		86 / 72		90 / 75	
			TC	PI	TC	PI	TC	PI	TC	PI	TC	PI	TC	PI
Three (3) Ducted Indoor Units	9 + 9 + 18	14	33.33	1.78	35.40	1.84	37.47	1.91	38.96	1.93	41.61	1.97	43.68	2.01
		20	33.30	1.80	35.37	1.87	37.44	1.94	38.94	1.96	41.58	2.00	43.65	2.04
		25	33.28	1.83	35.35	1.90	37.41	1.96	38.91	1.99	41.55	2.02	43.61	2.06
		30	33.25	1.85	35.32	1.92	37.38	1.99	38.88	2.01	41.51	2.05	43.58	2.09
		35	33.23	1.88	35.29	1.95	37.36	2.02	38.85	2.04	41.48	2.08	43.55	2.12
		40	33.20	1.90	35.27	1.97	37.33	2.05	38.82	2.07	41.45	2.11	43.51	2.15
		45	33.18	1.93	35.24	2.00	37.30	2.07	38.79	2.10	41.42	2.14	43.48	2.18
		50	33.15	1.96	35.21	2.03	37.27	2.10	38.76	2.13	41.39	2.17	43.45	2.21
		55	33.13	1.98	35.18	2.05	37.24	2.13	38.73	2.15	41.36	2.19	43.41	2.24
		60	33.10	2.01	35.16	2.08	37.21	2.16	38.70	2.18	41.32	2.22	43.38	2.27
		65	33.08	2.03	35.13	2.11	37.18	2.18	38.67	2.21	41.29	2.25	43.35	2.30
		70	33.05	2.06	35.10	2.13	37.16	2.21	38.64	2.24	41.26	2.28	43.31	2.32
		75	32.26	2.17	34.30	2.25	36.35	2.33	37.83	2.36	40.45	2.40	42.49	2.45
		80	31.46	2.28	33.50	2.36	35.54	2.45	37.02	2.48	39.63	2.52	41.67	2.58
		85	30.67	2.39	32.71	2.48	34.75	2.57	36.22	2.60	38.82	2.65	40.86	2.70
		90	29.88	2.50	31.92	2.59	33.95	2.69	35.42	2.72	38.01	2.77	40.05	2.83
		95	29.03	2.61	31.05	2.71	33.07	2.81	<b>34.00</b>	<b>2.84</b>	37.12	2.89	39.14	2.95
		100	28.32	2.72	30.34	2.82	32.37	2.93	33.56	2.96	36.41	3.02	38.43	3.08
		105	27.61	2.84	29.64	2.94	31.66	3.05	33.12	3.08	35.70	3.14	37.73	3.20
		110	26.91	2.95	28.93	3.05	30.95	3.17	32.41	3.20	35.00	3.26	37.02	3.33
		115	26.20	3.06	28.22	3.17	30.24	3.28	31.71	3.32	34.29	3.38	36.31	3.45
	118	25.78	3.12	27.80	3.24	29.82	3.36	31.28	3.40	33.87	3.46	35.89	3.53	
	122	25.63	3.21	27.66	3.33	29.68	3.45	31.14	3.49	33.72	3.56	35.75	3.63	
	9 + 12 + 18	14	33.33	1.78	35.40	1.84	37.47	1.91	38.96	1.93	41.61	1.97	43.68	2.01
		20	33.30	1.80	35.37	1.87	37.44	1.94	38.94	1.96	41.58	2.00	43.65	2.04
		25	33.28	1.83	35.35	1.90	37.41	1.96	38.91	1.99	41.55	2.02	43.61	2.06
		30	33.25	1.85	35.32	1.92	37.38	1.99	38.88	2.01	41.51	2.05	43.58	2.09
		35	33.23	1.88	35.29	1.95	37.36	2.02	38.85	2.04	41.48	2.08	43.55	2.12
		40	33.20	1.90	35.27	1.97	37.33	2.05	38.82	2.07	41.45	2.11	43.51	2.15
		45	33.18	1.93	35.24	2.00	37.30	2.07	38.79	2.10	41.42	2.14	43.48	2.18
		50	33.15	1.96	35.21	2.03	37.27	2.10	38.76	2.13	41.39	2.17	43.45	2.21
		55	33.13	1.98	35.18	2.05	37.24	2.13	38.73	2.15	41.36	2.19	43.41	2.24
		60	33.10	2.01	35.16	2.08	37.21	2.16	38.70	2.18	41.32	2.22	43.38	2.27
		65	33.08	2.03	35.13	2.11	37.18	2.18	38.67	2.21	41.29	2.25	43.35	2.30
		70	33.05	2.06	35.10	2.13	37.16	2.21	38.64	2.24	41.26	2.28	43.31	2.32
		75	32.26	2.17	34.30	2.25	36.35	2.33	37.83	2.36	40.45	2.40	42.49	2.45
		80	31.46	2.28	33.50	2.36	35.54	2.45	37.02	2.48	39.63	2.52	41.67	2.58
		85	30.67	2.39	32.71	2.48	34.75	2.57	36.22	2.60	38.82	2.65	40.86	2.70
		90	29.88	2.50	31.92	2.59	33.95	2.69	35.42	2.72	38.01	2.77	40.05	2.83
		95	29.03	2.61	31.05	2.71	33.07	2.81	<b>34.00</b>	<b>2.84</b>	37.12	2.89	39.14	2.95
		100	28.32	2.72	30.34	2.82	32.37	2.93	33.56	2.96	36.41	3.02	38.43	3.08
		105	27.61	2.84	29.64	2.94	31.66	3.05	33.12	3.08	35.70	3.14	37.73	3.20
110		26.91	2.95	28.93	3.05	30.95	3.17	32.41	3.20	35.00	3.26	37.02	3.33	
115		26.20	3.06	28.22	3.17	30.24	3.28	31.71	3.32	34.29	3.38	36.31	3.45	
118	25.78	3.12	27.80	3.24	29.82	3.36	31.28	3.40	33.87	3.46	35.89	3.53		
122	25.63	3.21	27.66	3.33	29.68	3.45	31.14	3.49	33.72	3.56	35.75	3.63		

TC = Total Capacity (kBtu/h).

PI = Power Input (kW).

Nominal capacity as rated: 0 ft. above sea level with 25 ft. of refrigerant piping.  
0 ft. level difference between outdoor and indoor units.

Nominal cooling capacity rating obtained with air entering the indoor unit at 80°F dry bulb (DB) and 67°F wet bulb (WB), and outdoor ambient conditions of 95°F dry bulb (DB) and 75°F wet bulb (WB).

The shaded table rows indicate reference data. When operating at this temperature, these values can be different if the system is not running consistently.

# PERFORMANCE DATA

## Cooling Capacity Tables

MULTI F  
MULTI F MAX

Table 58: LMU369HV Cooling Capacity Table — Ducted Indoor Units (continued).

Connected Indoor Units	Combination Capacity Index	Outdoor Air Temp. (°F DB)	Indoor Air Temp. °F DB / °F WB											
			68 / 57		73 / 61		77 / 64		80 / 67		86 / 72		90 / 75	
			TC	PI	TC	PI	TC	PI	TC	PI	TC	PI	TC	PI
Three (3) Ducted Indoor Units	12 + 12 + 18	14	33.33	1.78	35.40	1.84	37.47	1.91	38.96	1.93	41.61	1.97	43.68	2.01
		20	33.30	1.80	35.37	1.87	37.44	1.94	38.94	1.96	41.58	2.00	43.65	2.04
		25	33.28	1.83	35.35	1.90	37.41	1.96	38.91	1.99	41.55	2.02	43.61	2.06
		30	33.25	1.85	35.32	1.92	37.38	1.99	38.88	2.01	41.51	2.05	43.58	2.09
		35	33.23	1.88	35.29	1.95	37.36	2.02	38.85	2.04	41.48	2.08	43.55	2.12
		40	33.20	1.90	35.27	1.97	37.33	2.05	38.82	2.07	41.45	2.11	43.51	2.15
		45	33.18	1.93	35.24	2.00	37.30	2.07	38.79	2.10	41.42	2.14	43.48	2.18
		50	33.15	1.96	35.21	2.03	37.27	2.10	38.76	2.13	41.39	2.17	43.45	2.21
		55	33.13	1.98	35.18	2.05	37.24	2.13	38.73	2.15	41.36	2.19	43.41	2.24
		60	33.10	2.01	35.16	2.08	37.21	2.16	38.70	2.18	41.32	2.22	43.38	2.27
		65	33.08	2.03	35.13	2.11	37.18	2.18	38.67	2.21	41.29	2.25	43.35	2.30
		70	33.05	2.06	35.10	2.13	37.16	2.21	38.64	2.24	41.26	2.28	43.31	2.32
	75	32.26	2.17	34.30	2.25	36.35	2.33	37.83	2.36	40.45	2.40	42.49	2.45	
	80	31.46	2.28	33.50	2.36	35.54	2.45	37.02	2.48	39.63	2.52	41.67	2.58	
	85	30.67	2.39	32.71	2.48	34.75	2.57	36.22	2.60	38.82	2.65	40.86	2.70	
	90	29.88	2.50	31.92	2.59	33.95	2.69	35.42	2.72	38.01	2.77	40.05	2.83	
	95	29.03	2.61	31.05	2.71	33.07	2.81	<b>34.00</b>	<b>2.84</b>	37.12	2.89	39.14	2.95	
	100	28.32	2.72	30.34	2.82	32.37	2.93	33.56	2.96	36.41	3.02	38.43	3.08	
	105	27.61	2.84	29.64	2.94	31.66	3.05	33.12	3.08	35.70	3.14	37.73	3.20	
	110	26.91	2.95	28.93	3.05	30.95	3.17	32.41	3.20	35.00	3.26	37.02	3.33	
	115	26.20	3.06	28.22	3.17	30.24	3.28	31.71	3.32	34.29	3.38	36.31	3.45	
	118	25.78	3.12	27.80	3.24	29.82	3.36	31.28	3.40	33.87	3.46	35.89	3.53	
	122	25.63	3.21	27.66	3.33	29.68	3.45	31.14	3.49	33.72	3.56	35.75	3.63	
	9 + 18 + 18	14	33.33	1.78	35.40	1.84	37.47	1.91	38.96	1.93	41.61	1.97	43.68	2.01
20		33.30	1.80	35.37	1.87	37.44	1.94	38.94	1.96	41.58	2.00	43.65	2.04	
25		33.28	1.83	35.35	1.90	37.41	1.96	38.91	1.99	41.55	2.02	43.61	2.06	
30		33.25	1.85	35.32	1.92	37.38	1.99	38.88	2.01	41.51	2.05	43.58	2.09	
35		33.23	1.88	35.29	1.95	37.36	2.02	38.85	2.04	41.48	2.08	43.55	2.12	
40		33.20	1.90	35.27	1.97	37.33	2.05	38.82	2.07	41.45	2.11	43.51	2.15	
45		33.18	1.93	35.24	2.00	37.30	2.07	38.79	2.10	41.42	2.14	43.48	2.18	
50		33.15	1.96	35.21	2.03	37.27	2.10	38.76	2.13	41.39	2.17	43.45	2.21	
55		33.13	1.98	35.18	2.05	37.24	2.13	38.73	2.15	41.36	2.19	43.41	2.24	
60		33.10	2.01	35.16	2.08	37.21	2.16	38.70	2.18	41.32	2.22	43.38	2.27	
65		33.08	2.03	35.13	2.11	37.18	2.18	38.67	2.21	41.29	2.25	43.35	2.30	
70		33.05	2.06	35.10	2.13	37.16	2.21	38.64	2.24	41.26	2.28	43.31	2.32	
75	32.26	2.17	34.30	2.25	36.35	2.33	37.83	2.36	40.45	2.40	42.49	2.45		
80	31.46	2.28	33.50	2.36	35.54	2.45	37.02	2.48	39.63	2.52	41.67	2.58		
85	30.67	2.39	32.71	2.48	34.75	2.57	36.22	2.60	38.82	2.65	40.86	2.70		
90	29.88	2.50	31.92	2.59	33.95	2.69	35.42	2.72	38.01	2.77	40.05	2.83		
95	29.03	2.61	31.05	2.71	33.07	2.81	<b>34.00</b>	<b>2.84</b>	37.12	2.89	39.14	2.95		
100	28.32	2.72	30.34	2.82	32.37	2.93	33.56	2.96	36.41	3.02	38.43	3.08		
105	27.61	2.84	29.64	2.94	31.66	3.05	33.12	3.08	35.70	3.14	37.73	3.20		
110	26.91	2.95	28.93	3.05	30.95	3.17	32.41	3.20	35.00	3.26	37.02	3.33		
115	26.20	3.06	28.22	3.17	30.24	3.28	31.71	3.32	34.29	3.38	36.31	3.45		
118	25.78	3.12	27.80	3.24	29.82	3.36	31.28	3.40	33.87	3.46	35.89	3.53		
122	25.63	3.21	27.66	3.33	29.68	3.45	31.14	3.49	33.72	3.56	35.75	3.63		

TC = Total Capacity (kBtu/h).

PI = Power Input (kW).

Nominal capacity as rated: 0 ft. above sea level with 25 ft. of refrigerant piping.  
0 ft. level difference between outdoor and indoor units.

Nominal cooling capacity rating obtained with air entering the indoor unit at 80°F dry bulb (DB) and 67°F wet bulb (WB), and outdoor ambient conditions of 95°F dry bulb (DB) and 75°F wet bulb (WB).

The shaded table rows indicate reference data. When operating at this temperature, these values can be different if the system is not running consistently.



Multi F and Multi F MAX Heat Pump System Engineering Manual

Table 59: LMU369HV Cooling Capacity Table — Ducted Indoor Units (continued).

Connected Indoor Units	Combination Capacity Index	Outdoor Air Temp. (°F DB)	Indoor Air Temp. °F DB / °F WB											
			68 / 57		73 / 61		77 / 64		80 / 67		86 / 72		90 / 75	
			TC	PI	TC	PI	TC	PI	TC	PI	TC	PI	TC	PI
Three (3) Ducted Indoor Units	12 + 18 + 18	14	33.33	1.78	35.40	1.84	37.47	1.91	38.96	1.93	41.61	1.97	43.68	2.01
		20	33.30	1.80	35.37	1.87	37.44	1.94	38.94	1.96	41.58	2.00	43.65	2.04
		25	33.28	1.83	35.35	1.90	37.41	1.96	38.91	1.99	41.55	2.02	43.61	2.06
		30	33.25	1.85	35.32	1.92	37.38	1.99	38.88	2.01	41.51	2.05	43.58	2.09
		35	33.23	1.88	35.29	1.95	37.36	2.02	38.85	2.04	41.48	2.08	43.55	2.12
		40	33.20	1.90	35.27	1.97	37.33	2.05	38.82	2.07	41.45	2.11	43.51	2.15
		45	33.18	1.93	35.24	2.00	37.30	2.07	38.79	2.10	41.42	2.14	43.48	2.18
		50	33.15	1.96	35.21	2.03	37.27	2.10	38.76	2.13	41.39	2.17	43.45	2.21
		55	33.13	1.98	35.18	2.05	37.24	2.13	38.73	2.15	41.36	2.19	43.41	2.24
		60	33.10	2.01	35.16	2.08	37.21	2.16	38.70	2.18	41.32	2.22	43.38	2.27
		65	33.08	2.03	35.13	2.11	37.18	2.18	38.67	2.21	41.29	2.25	43.35	2.30
		70	33.05	2.06	35.10	2.13	37.16	2.21	38.64	2.24	41.26	2.28	43.31	2.32
		75	32.26	2.17	34.30	2.25	36.35	2.33	37.83	2.36	40.45	2.40	42.49	2.45
		80	31.46	2.28	33.50	2.36	35.54	2.45	37.02	2.48	39.63	2.52	41.67	2.58
		85	30.67	2.39	32.71	2.48	34.75	2.57	36.22	2.60	38.82	2.65	40.86	2.70
		90	29.88	2.50	31.92	2.59	33.95	2.69	35.42	2.72	38.01	2.77	40.05	2.83
		95	29.03	2.61	31.05	2.71	33.07	2.81	<b>34.00</b>	<b>2.84</b>	37.12	2.89	39.14	2.95
		100	28.32	2.72	30.34	2.82	32.37	2.93	33.56	2.96	36.41	3.02	38.43	3.08
105	27.61	2.84	29.64	2.94	31.66	3.05	33.12	3.08	35.70	3.14	37.73	3.20		
110	26.91	2.95	28.93	3.05	30.95	3.17	32.41	3.20	35.00	3.26	37.02	3.33		
115	26.20	3.06	28.22	3.17	30.24	3.28	31.71	3.32	34.29	3.38	36.31	3.45		
118	25.78	3.12	27.80	3.24	29.82	3.36	31.28	3.40	33.87	3.46	35.89	3.53		
122	25.63	3.21	27.66	3.33	29.68	3.45	31.14	3.49	33.72	3.56	35.75	3.63		
Four (4) Ducted Indoor Units	9 + 9 + 9 + 9	14	33.33	1.78	35.40	1.84	37.47	1.91	38.96	1.93	41.61	1.97	43.68	2.01
		20	33.30	1.80	35.37	1.87	37.44	1.94	38.94	1.96	41.58	2.00	43.65	2.04
		25	33.28	1.83	35.35	1.90	37.41	1.96	38.91	1.99	41.55	2.02	43.61	2.06
		30	33.25	1.85	35.32	1.92	37.38	1.99	38.88	2.01	41.51	2.05	43.58	2.09
		35	33.23	1.88	35.29	1.95	37.36	2.02	38.85	2.04	41.48	2.08	43.55	2.12
		40	33.20	1.90	35.27	1.97	37.33	2.05	38.82	2.07	41.45	2.11	43.51	2.15
		45	33.18	1.93	35.24	2.00	37.30	2.07	38.79	2.10	41.42	2.14	43.48	2.18
		50	33.15	1.96	35.21	2.03	37.27	2.10	38.76	2.13	41.39	2.17	43.45	2.21
		55	33.13	1.98	35.18	2.05	37.24	2.13	38.73	2.15	41.36	2.19	43.41	2.24
		60	33.10	2.01	35.16	2.08	37.21	2.16	38.70	2.18	41.32	2.22	43.38	2.27
		65	33.08	2.03	35.13	2.11	37.18	2.18	38.67	2.21	41.29	2.25	43.35	2.30
		70	33.05	2.06	35.10	2.13	37.16	2.21	38.64	2.24	41.26	2.28	43.31	2.32
		75	32.26	2.17	34.30	2.25	36.35	2.33	37.83	2.36	40.45	2.40	42.49	2.45
		80	31.46	2.28	33.50	2.36	35.54	2.45	37.02	2.48	39.63	2.52	41.67	2.58
		85	30.67	2.39	32.71	2.48	34.75	2.57	36.22	2.60	38.82	2.65	40.86	2.70
		90	29.88	2.50	31.92	2.59	33.95	2.69	35.42	2.72	38.01	2.77	40.05	2.83
		95	29.03	2.61	31.05	2.71	33.07	2.81	<b>34.00</b>	<b>2.84</b>	37.12	2.89	39.14	2.95
		100	28.32	2.72	30.34	2.82	32.37	2.93	33.56	2.96	36.41	3.02	38.43	3.08
105	27.61	2.84	29.64	2.94	31.66	3.05	33.12	3.08	35.70	3.14	37.73	3.20		
110	26.91	2.95	28.93	3.05	30.95	3.17	32.41	3.20	35.00	3.26	37.02	3.33		
115	26.20	3.06	28.22	3.17	30.24	3.28	31.71	3.32	34.29	3.38	36.31	3.45		
118	25.78	3.12	27.80	3.24	29.82	3.36	31.28	3.40	33.87	3.46	35.89	3.53		
122	25.63	3.21	27.66	3.33	29.68	3.45	31.14	3.49	33.72	3.56	35.75	3.63		

TC = Total Capacity (kBtu/h).

PI = Power Input (kW).

Nominal capacity as rated: 0 ft. above sea level with 25 ft. of refrigerant piping.  
0 ft. level difference between outdoor and indoor units.

Nominal cooling capacity rating obtained with air entering the indoor unit at 80°F dry bulb (DB) and 67°F wet bulb (WB), and outdoor ambient conditions of 95°F dry bulb (DB) and 75°F wet bulb (WB).

The shaded table rows indicate reference data. When operating at this temperature, these values can be different if the system is not running consistently.

# PERFORMANCE DATA

## Cooling Capacity Tables

MULTI F  
MULTI F MAX

Table 60: LMU369HV Cooling Capacity Table — Ducted Indoor Units (continued).

Connected Indoor Units	Combination Capacity Index	Outdoor Air Temp. (°F DB)	Indoor Air Temp. °F DB / °F WB											
			68 / 57		73 / 61		77 / 64		80 / 67		86 / 72		90 / 75	
			TC	PI	TC	PI	TC	PI	TC	PI	TC	PI	TC	PI
Four (4) Ducted Indoor Units	9 + 9 + 9 + 12	14	33.33	1.78	35.40	1.84	37.47	1.91	38.96	1.93	41.61	1.97	43.68	2.01
		20	33.30	1.80	35.37	1.87	37.44	1.94	38.94	1.96	41.58	2.00	43.65	2.04
		25	33.28	1.83	35.35	1.90	37.41	1.96	38.91	1.99	41.55	2.02	43.61	2.06
		30	33.25	1.85	35.32	1.92	37.38	1.99	38.88	2.01	41.51	2.05	43.58	2.09
		35	33.23	1.88	35.29	1.95	37.36	2.02	38.85	2.04	41.48	2.08	43.55	2.12
		40	33.20	1.90	35.27	1.97	37.33	2.05	38.82	2.07	41.45	2.11	43.51	2.15
		45	33.18	1.93	35.24	2.00	37.30	2.07	38.79	2.10	41.42	2.14	43.48	2.18
		50	33.15	1.96	35.21	2.03	37.27	2.10	38.76	2.13	41.39	2.17	43.45	2.21
		55	33.13	1.98	35.18	2.05	37.24	2.13	38.73	2.15	41.36	2.19	43.41	2.24
		60	33.10	2.01	35.16	2.08	37.21	2.16	38.70	2.18	41.32	2.22	43.38	2.27
		65	33.08	2.03	35.13	2.11	37.18	2.18	38.67	2.21	41.29	2.25	43.35	2.30
		70	33.05	2.06	35.10	2.13	37.16	2.21	38.64	2.24	41.26	2.28	43.31	2.32
		75	32.26	2.17	34.30	2.25	36.35	2.33	37.83	2.36	40.45	2.40	42.49	2.45
		80	31.46	2.28	33.50	2.36	35.54	2.45	37.02	2.48	39.63	2.52	41.67	2.58
		85	30.67	2.39	32.71	2.48	34.75	2.57	36.22	2.60	38.82	2.65	40.86	2.70
		90	29.88	2.50	31.92	2.59	33.95	2.69	35.42	2.72	38.01	2.77	40.05	2.83
		95	29.03	2.61	31.05	2.71	33.07	2.81	<b>34.00</b>	<b>2.84</b>	37.12	2.89	39.14	2.95
		100	28.32	2.72	30.34	2.82	32.37	2.93	33.56	2.96	36.41	3.02	38.43	3.08
		105	27.61	2.84	29.64	2.94	31.66	3.05	33.12	3.08	35.70	3.14	37.73	3.20
		110	26.91	2.95	28.93	3.05	30.95	3.17	32.41	3.20	35.00	3.26	37.02	3.33
		115	26.20	3.06	28.22	3.17	30.24	3.28	31.71	3.32	34.29	3.38	36.31	3.45
	118	25.78	3.12	27.80	3.24	29.82	3.36	31.28	3.40	33.87	3.46	35.89	3.53	
	122	25.63	3.21	27.66	3.33	29.68	3.45	31.14	3.49	33.72	3.56	35.75	3.63	
	9 + 9 + 12 + 12	14	33.33	1.78	35.40	1.84	37.47	1.91	38.96	1.93	41.61	1.97	43.68	2.01
		20	33.30	1.80	35.37	1.87	37.44	1.94	38.94	1.96	41.58	2.00	43.65	2.04
		25	33.28	1.83	35.35	1.90	37.41	1.96	38.91	1.99	41.55	2.02	43.61	2.06
		30	33.25	1.85	35.32	1.92	37.38	1.99	38.88	2.01	41.51	2.05	43.58	2.09
		35	33.23	1.88	35.29	1.95	37.36	2.02	38.85	2.04	41.48	2.08	43.55	2.12
		40	33.20	1.90	35.27	1.97	37.33	2.05	38.82	2.07	41.45	2.11	43.51	2.15
		45	33.18	1.93	35.24	2.00	37.30	2.07	38.79	2.10	41.42	2.14	43.48	2.18
		50	33.15	1.96	35.21	2.03	37.27	2.10	38.76	2.13	41.39	2.17	43.45	2.21
		55	33.13	1.98	35.18	2.05	37.24	2.13	38.73	2.15	41.36	2.19	43.41	2.24
		60	33.10	2.01	35.16	2.08	37.21	2.16	38.70	2.18	41.32	2.22	43.38	2.27
		65	33.08	2.03	35.13	2.11	37.18	2.18	38.67	2.21	41.29	2.25	43.35	2.30
		70	33.05	2.06	35.10	2.13	37.16	2.21	38.64	2.24	41.26	2.28	43.31	2.32
		75	32.26	2.17	34.30	2.25	36.35	2.33	37.83	2.36	40.45	2.40	42.49	2.45
		80	31.46	2.28	33.50	2.36	35.54	2.45	37.02	2.48	39.63	2.52	41.67	2.58
		85	30.67	2.39	32.71	2.48	34.75	2.57	36.22	2.60	38.82	2.65	40.86	2.70
		90	29.88	2.50	31.92	2.59	33.95	2.69	35.42	2.72	38.01	2.77	40.05	2.83
		95	29.03	2.61	31.05	2.71	33.07	2.81	<b>34.00</b>	<b>2.84</b>	37.12	2.89	39.14	2.95
		100	28.32	2.72	30.34	2.82	32.37	2.93	33.56	2.96	36.41	3.02	38.43	3.08
		105	27.61	2.84	29.64	2.94	31.66	3.05	33.12	3.08	35.70	3.14	37.73	3.20
110		26.91	2.95	28.93	3.05	30.95	3.17	32.41	3.20	35.00	3.26	37.02	3.33	
115		26.20	3.06	28.22	3.17	30.24	3.28	31.71	3.32	34.29	3.38	36.31	3.45	
118	25.78	3.12	27.80	3.24	29.82	3.36	31.28	3.40	33.87	3.46	35.89	3.53		
122	25.63	3.21	27.66	3.33	29.68	3.45	31.14	3.49	33.72	3.56	35.75	3.63		

TC = Total Capacity (kBtu/h).

PI = Power Input (kW).

Nominal capacity as rated: 0 ft. above sea level with 25 ft. of refrigerant piping.  
0 ft. level difference between outdoor and indoor units.

Nominal cooling capacity rating obtained with air entering the indoor unit at 80°F dry bulb (DB) and 67°F wet bulb (WB), and outdoor ambient conditions of 95°F dry bulb (DB) and 75°F wet bulb (WB).

The shaded table rows indicate reference data. When operating at this temperature, these values can be different if the system is not running consistently.



Multi F and Multi F MAX Heat Pump System Engineering Manual

Table 61: LMU369HV Cooling Capacity Table — Ducted Indoor Units (continued).

Connected Indoor Units	Combination Capacity Index	Outdoor Air Temp. (°F DB)	Indoor Air Temp. °F DB / °F WB											
			68 / 57		73 / 61		77 / 64		80 / 67		86 / 72		90 / 75	
			TC	PI	TC	PI	TC	PI	TC	PI	TC	PI	TC	PI
Four (4) Ducted Indoor Units	9 + 12 + 12 + 12	14	33.33	1.78	35.40	1.84	37.47	1.91	38.96	1.93	41.61	1.97	43.68	2.01
		20	33.30	1.80	35.37	1.87	37.44	1.94	38.94	1.96	41.58	2.00	43.65	2.04
		25	33.28	1.83	35.35	1.90	37.41	1.96	38.91	1.99	41.55	2.02	43.61	2.06
		30	33.25	1.85	35.32	1.92	37.38	1.99	38.88	2.01	41.51	2.05	43.58	2.09
		35	33.23	1.88	35.29	1.95	37.36	2.02	38.85	2.04	41.48	2.08	43.55	2.12
		40	33.20	1.90	35.27	1.97	37.33	2.05	38.82	2.07	41.45	2.11	43.51	2.15
		45	33.18	1.93	35.24	2.00	37.30	2.07	38.79	2.10	41.42	2.14	43.48	2.18
		50	33.15	1.96	35.21	2.03	37.27	2.10	38.76	2.13	41.39	2.17	43.45	2.21
		55	33.13	1.98	35.18	2.05	37.24	2.13	38.73	2.15	41.36	2.19	43.41	2.24
		60	33.10	2.01	35.16	2.08	37.21	2.16	38.70	2.18	41.32	2.22	43.38	2.27
		65	33.08	2.03	35.13	2.11	37.18	2.18	38.67	2.21	41.29	2.25	43.35	2.30
		70	33.05	2.06	35.10	2.13	37.16	2.21	38.64	2.24	41.26	2.28	43.31	2.32
		75	32.26	2.17	34.30	2.25	36.35	2.33	37.83	2.36	40.45	2.40	42.49	2.45
		80	31.46	2.28	33.50	2.36	35.54	2.45	37.02	2.48	39.63	2.52	41.67	2.58
		85	30.67	2.39	32.71	2.48	34.75	2.57	36.22	2.60	38.82	2.65	40.86	2.70
		90	29.88	2.50	31.92	2.59	33.95	2.69	35.42	2.72	38.01	2.77	40.05	2.83
		95	29.03	2.61	31.05	2.71	33.07	2.81	<b>34.00</b>	<b>2.84</b>	37.12	2.89	39.14	2.95
		100	28.32	2.72	30.34	2.82	32.37	2.93	33.56	2.96	36.41	3.02	38.43	3.08
		105	27.61	2.84	29.64	2.94	31.66	3.05	33.12	3.08	35.70	3.14	37.73	3.20
		110	26.91	2.95	28.93	3.05	30.95	3.17	32.41	3.20	35.00	3.26	37.02	3.33
		115	26.20	3.06	28.22	3.17	30.24	3.28	31.71	3.32	34.29	3.38	36.31	3.45
	118	25.78	3.12	27.80	3.24	29.82	3.36	31.28	3.40	33.87	3.46	35.89	3.53	
	122	25.63	3.21	27.66	3.33	29.68	3.45	31.14	3.49	33.72	3.56	35.75	3.63	
	9 + 9 + 9 + 18	14	33.33	1.78	35.40	1.84	37.47	1.91	38.96	1.93	41.61	1.97	43.68	2.01
		20	33.30	1.80	35.37	1.87	37.44	1.94	38.94	1.96	41.58	2.00	43.65	2.04
		25	33.28	1.83	35.35	1.90	37.41	1.96	38.91	1.99	41.55	2.02	43.61	2.06
		30	33.25	1.85	35.32	1.92	37.38	1.99	38.88	2.01	41.51	2.05	43.58	2.09
		35	33.23	1.88	35.29	1.95	37.36	2.02	38.85	2.04	41.48	2.08	43.55	2.12
		40	33.20	1.90	35.27	1.97	37.33	2.05	38.82	2.07	41.45	2.11	43.51	2.15
		45	33.18	1.93	35.24	2.00	37.30	2.07	38.79	2.10	41.42	2.14	43.48	2.18
		50	33.15	1.96	35.21	2.03	37.27	2.10	38.76	2.13	41.39	2.17	43.45	2.21
		55	33.13	1.98	35.18	2.05	37.24	2.13	38.73	2.15	41.36	2.19	43.41	2.24
		60	33.10	2.01	35.16	2.08	37.21	2.16	38.70	2.18	41.32	2.22	43.38	2.27
		65	33.08	2.03	35.13	2.11	37.18	2.18	38.67	2.21	41.29	2.25	43.35	2.30
		70	33.05	2.06	35.10	2.13	37.16	2.21	38.64	2.24	41.26	2.28	43.31	2.32
		75	32.26	2.17	34.30	2.25	36.35	2.33	37.83	2.36	40.45	2.40	42.49	2.45
		80	31.46	2.28	33.50	2.36	35.54	2.45	37.02	2.48	39.63	2.52	41.67	2.58
		85	30.67	2.39	32.71	2.48	34.75	2.57	36.22	2.60	38.82	2.65	40.86	2.70
		90	29.88	2.50	31.92	2.59	33.95	2.69	35.42	2.72	38.01	2.77	40.05	2.83
		95	29.03	2.61	31.05	2.71	33.07	2.81	<b>34.00</b>	<b>2.84</b>	37.12	2.89	39.14	2.95
		100	28.32	2.72	30.34	2.82	32.37	2.93	33.56	2.96	36.41	3.02	38.43	3.08
		105	27.61	2.84	29.64	2.94	31.66	3.05	33.12	3.08	35.70	3.14	37.73	3.20
110		26.91	2.95	28.93	3.05	30.95	3.17	32.41	3.20	35.00	3.26	37.02	3.33	
115		26.20	3.06	28.22	3.17	30.24	3.28	31.71	3.32	34.29	3.38	36.31	3.45	
118	25.78	3.12	27.80	3.24	29.82	3.36	31.28	3.40	33.87	3.46	35.89	3.53		
122	25.63	3.21	27.66	3.33	29.68	3.45	31.14	3.49	33.72	3.56	35.75	3.63		

TC = Total Capacity (kBtu/h).

PI = Power Input (kW).

Nominal capacity as rated: 0 ft. above sea level with 25 ft. of refrigerant piping.  
0 ft. level difference between outdoor and indoor units.

Nominal cooling capacity rating obtained with air entering the indoor unit at 80°F dry bulb (DB) and 67°F wet bulb (WB), and outdoor ambient conditions of 95°F dry bulb (DB) and 75°F wet bulb (WB).

The shaded table rows indicate reference data. When operating at this temperature, these values can be different if the system is not running consistently.

# PERFORMANCE DATA

## Cooling Capacity Tables

MULTI F  
MULTI F MAX

Table 62: LMU369HV Cooling Capacity Table — Ducted Indoor Units (continued).

Connected Indoor Units	Combination Capacity Index	Outdoor Air Temp. (°F DB)	Indoor Air Temp. °F DB / °F WB											
			68 / 57		73 / 61		77 / 64		80 / 67		86 / 72		90 / 75	
			TC	PI	TC	PI	TC	PI	TC	PI	TC	PI	TC	PI
Four (4) Ducted Indoor Units	9 + 9 + 12 + 18	14	33.33	1.78	35.40	1.84	37.47	1.91	38.96	1.93	41.61	1.97	43.68	2.01
		20	33.30	1.80	35.37	1.87	37.44	1.94	38.94	1.96	41.58	2.00	43.65	2.04
		25	33.28	1.83	35.35	1.90	37.41	1.96	38.91	1.99	41.55	2.02	43.61	2.06
		30	33.25	1.85	35.32	1.92	37.38	1.99	38.88	2.01	41.51	2.05	43.58	2.09
		35	33.23	1.88	35.29	1.95	37.36	2.02	38.85	2.04	41.48	2.08	43.55	2.12
		40	33.20	1.90	35.27	1.97	37.33	2.05	38.82	2.07	41.45	2.11	43.51	2.15
		45	33.18	1.93	35.24	2.00	37.30	2.07	38.79	2.10	41.42	2.14	43.48	2.18
		50	33.15	1.96	35.21	2.03	37.27	2.10	38.76	2.13	41.39	2.17	43.45	2.21
		55	33.13	1.98	35.18	2.05	37.24	2.13	38.73	2.15	41.36	2.19	43.41	2.24
		60	33.10	2.01	35.16	2.08	37.21	2.16	38.70	2.18	41.32	2.22	43.38	2.27
		65	33.08	2.03	35.13	2.11	37.18	2.18	38.67	2.21	41.29	2.25	43.35	2.30
		70	33.05	2.06	35.10	2.13	37.16	2.21	38.64	2.24	41.26	2.28	43.31	2.32
		75	32.26	2.17	34.30	2.25	36.35	2.33	37.83	2.36	40.45	2.40	42.49	2.45
		80	31.46	2.28	33.50	2.36	35.54	2.45	37.02	2.48	39.63	2.52	41.67	2.58
		85	30.67	2.39	32.71	2.48	34.75	2.57	36.22	2.60	38.82	2.65	40.86	2.70
		90	29.88	2.50	31.92	2.59	33.95	2.69	35.42	2.72	38.01	2.77	40.05	2.83
		95	29.03	2.61	31.05	2.71	33.07	2.81	<b>34.00</b>	<b>2.84</b>	37.12	2.89	39.14	2.95
		100	28.32	2.72	30.34	2.82	32.37	2.93	33.56	2.96	36.41	3.02	38.43	3.08
	105	27.61	2.84	29.64	2.94	31.66	3.05	33.12	3.08	35.70	3.14	37.73	3.20	
	110	26.91	2.95	28.93	3.05	30.95	3.17	32.41	3.20	35.00	3.26	37.02	3.33	
	115	26.20	3.06	28.22	3.17	30.24	3.28	31.71	3.32	34.29	3.38	36.31	3.45	
	118	25.78	3.12	27.80	3.24	29.82	3.36	31.28	3.40	33.87	3.46	35.89	3.53	
	122	25.63	3.21	27.66	3.33	29.68	3.45	31.14	3.49	33.72	3.56	35.75	3.63	
	12 + 12 + 12 + 12	14	33.33	1.78	35.40	1.84	37.47	1.91	38.96	1.93	41.61	1.97	43.68	2.01
		20	33.30	1.80	35.37	1.87	37.44	1.94	38.94	1.96	41.58	2.00	43.65	2.04
		25	33.28	1.83	35.35	1.90	37.41	1.96	38.91	1.99	41.55	2.02	43.61	2.06
		30	33.25	1.85	35.32	1.92	37.38	1.99	38.88	2.01	41.51	2.05	43.58	2.09
		35	33.23	1.88	35.29	1.95	37.36	2.02	38.85	2.04	41.48	2.08	43.55	2.12
		40	33.20	1.90	35.27	1.97	37.33	2.05	38.82	2.07	41.45	2.11	43.51	2.15
		45	33.18	1.93	35.24	2.00	37.30	2.07	38.79	2.10	41.42	2.14	43.48	2.18
		50	33.15	1.96	35.21	2.03	37.27	2.10	38.76	2.13	41.39	2.17	43.45	2.21
		55	33.13	1.98	35.18	2.05	37.24	2.13	38.73	2.15	41.36	2.19	43.41	2.24
		60	33.10	2.01	35.16	2.08	37.21	2.16	38.70	2.18	41.32	2.22	43.38	2.27
		65	33.08	2.03	35.13	2.11	37.18	2.18	38.67	2.21	41.29	2.25	43.35	2.30
		70	33.05	2.06	35.10	2.13	37.16	2.21	38.64	2.24	41.26	2.28	43.31	2.32
		75	32.26	2.17	34.30	2.25	36.35	2.33	37.83	2.36	40.45	2.40	42.49	2.45
		80	31.46	2.28	33.50	2.36	35.54	2.45	37.02	2.48	39.63	2.52	41.67	2.58
		85	30.67	2.39	32.71	2.48	34.75	2.57	36.22	2.60	38.82	2.65	40.86	2.70
		90	29.88	2.50	31.92	2.59	33.95	2.69	35.42	2.72	38.01	2.77	40.05	2.83
		95	29.03	2.61	31.05	2.71	33.07	2.81	<b>34.00</b>	<b>2.84</b>	37.12	2.89	39.14	2.95
		100	28.32	2.72	30.34	2.82	32.37	2.93	33.56	2.96	36.41	3.02	38.43	3.08
	105	27.61	2.84	29.64	2.94	31.66	3.05	33.12	3.08	35.70	3.14	37.73	3.20	
110	26.91	2.95	28.93	3.05	30.95	3.17	32.41	3.20	35.00	3.26	37.02	3.33		
115	26.20	3.06	28.22	3.17	30.24	3.28	31.71	3.32	34.29	3.38	36.31	3.45		
118	25.78	3.12	27.80	3.24	29.82	3.36	31.28	3.40	33.87	3.46	35.89	3.53		
122	25.63	3.21	27.66	3.33	29.68	3.45	31.14	3.49	33.72	3.56	35.75	3.63		

TC = Total Capacity (kBtu/h).

PI = Power Input (kW).

Nominal capacity as rated: 0 ft. above sea level with 25 ft. of refrigerant piping.  
0 ft. level difference between outdoor and indoor units.

Nominal cooling capacity rating obtained with air entering the indoor unit at 80°F dry bulb (DB) and 67°F wet bulb (WB), and outdoor ambient conditions of 95°F dry bulb (DB) and 75°F wet bulb (WB).

The shaded table rows indicate reference data. When operating at this temperature, these values can be different if the system is not running consistently.



Multi F and Multi F MAX Heat Pump System Engineering Manual

Table 63: LMU369HV Cooling Capacity Table — Mixed Indoor Units

Connected Indoor Units	Combination Capacity Index	Outdoor Air Temp. (°F DB)	Indoor Air Temp. °F DB / °F WB											
			68 / 57		73 / 61		77 / 64		80 / 67		86 / 72		90 / 75	
			TC	PI	TC	PI	TC	PI	TC	PI	TC	PI	TC	PI
Two (2) Mixed Indoor Units	9 + 9	14	17.65	1.21	18.74	1.26	19.84	1.30	20.63	1.32	22.03	1.34	23.12	1.37
		20	17.63	1.23	18.73	1.28	19.82	1.32	20.61	1.34	22.01	1.36	23.11	1.39
		25	17.62	1.25	18.71	1.29	19.81	1.34	20.60	1.36	22.00	1.38	23.09	1.41
		30	17.60	1.27	18.70	1.31	19.79	1.36	20.58	1.38	21.98	1.40	23.07	1.43
		35	17.59	1.28	18.68	1.33	19.78	1.38	20.57	1.40	21.96	1.42	23.05	1.45
		40	17.58	1.30	18.67	1.35	19.76	1.40	20.55	1.41	21.94	1.44	23.04	1.47
		45	17.56	1.32	18.66	1.37	19.75	1.42	20.53	1.43	21.93	1.46	23.02	1.49
		50	17.55	1.34	18.64	1.38	19.73	1.44	20.52	1.45	21.91	1.48	23.00	1.51
		55	17.54	1.35	18.63	1.40	19.72	1.45	20.50	1.47	21.89	1.50	22.98	1.53
		60	17.52	1.37	18.61	1.42	19.70	1.47	20.49	1.49	21.88	1.52	22.97	1.55
		65	17.51	1.39	18.60	1.44	19.69	1.49	20.47	1.51	21.86	1.54	22.95	1.57
		70	17.50	1.41	18.58	1.46	19.67	1.51	20.46	1.53	21.84	1.56	22.93	1.59
		75	17.08	1.48	18.16	1.54	19.24	1.59	20.03	1.61	21.41	1.64	22.50	1.67
		80	16.66	1.56	17.74	1.61	18.82	1.67	19.60	1.69	20.98	1.72	22.06	1.76
		85	16.24	1.63	17.32	1.69	18.40	1.75	19.17	1.78	20.55	1.81	21.63	1.84
		90	15.82	1.71	16.90	1.77	17.97	1.84	18.75	1.86	20.12	1.89	21.20	1.93
		95	15.37	1.79	16.44	1.85	17.51	1.92	<b>18.00</b>	<b>1.94</b>	19.65	1.98	20.72	2.02
		100	14.99	1.86	16.06	1.93	17.13	2.00	17.77	2.02	19.28	2.06	20.35	2.10
	105	14.62	1.94	15.69	2.01	16.76	2.08	17.53	2.10	18.90	2.14	19.97	2.19	
	110	14.24	2.01	15.32	2.09	16.39	2.16	17.16	2.19	18.53	2.23	19.60	2.27	
	115	13.87	2.09	14.94	2.16	16.01	2.24	16.79	2.27	18.15	2.31	19.22	2.36	
	118	13.65	2.13	14.72	2.21	15.79	2.29	16.56	2.32	17.93	2.36	19.00	2.41	
	122	13.57	2.19	14.64	2.27	15.71	2.36	16.49	2.39	17.85	2.43	18.92	2.48	
	14	20.59	1.35	21.86	1.40	23.14	1.45	24.07	1.47	25.70	1.49	26.98	1.52	
	20	20.57	1.37	21.85	1.42	23.13	1.47	24.05	1.49	25.68	1.51	26.96	1.54	
	25	20.55	1.39	21.83	1.44	23.11	1.49	24.03	1.51	25.66	1.54	26.94	1.57	
	30	20.54	1.41	21.81	1.46	23.09	1.51	24.01	1.53	25.64	1.56	26.92	1.59	
	35	20.52	1.43	21.80	1.48	23.07	1.53	23.99	1.55	25.62	1.58	26.90	1.61	
	40	20.51	1.45	21.78	1.50	23.05	1.55	23.97	1.57	25.60	1.60	26.88	1.63	
	45	20.49	1.46	21.76	1.52	23.04	1.57	23.96	1.59	25.58	1.62	26.86	1.65	
	50	20.48	1.48	21.75	1.54	23.02	1.59	23.94	1.61	25.56	1.64	26.83	1.68	
	55	20.46	1.50	21.73	1.56	23.00	1.62	23.92	1.63	25.54	1.66	26.81	1.70	
	60	20.44	1.52	21.71	1.58	22.98	1.64	23.90	1.66	25.52	1.69	26.79	1.72	
	65	20.43	1.54	21.70	1.60	22.97	1.66	23.88	1.68	25.50	1.71	26.77	1.74	
	70	20.41	1.56	21.68	1.62	22.95	1.68	23.86	1.70	25.48	1.73	26.75	1.76	
	75	19.92	1.65	21.19	1.71	22.45	1.77	23.36	1.79	24.98	1.82	26.25	1.86	
	80	19.43	1.73	20.69	1.79	21.95	1.86	22.87	1.88	24.48	1.92	25.74	1.95	
	85	18.94	1.81	20.20	1.88	21.46	1.95	22.37	1.97	23.98	2.01	25.24	2.05	
	90	18.46	1.90	19.71	1.97	20.97	2.04	21.87	2.06	23.48	2.10	24.73	2.14	
	95	17.93	1.98	19.18	2.06	20.43	2.13	<b>21.00</b>	<b>2.16</b>	22.93	2.20	24.17	2.24	
	100	17.49	2.07	18.74	2.14	19.99	2.22	20.73	2.25	22.49	2.29	23.74	2.33	
	105	17.06	2.15	18.30	2.23	19.55	2.31	20.46	2.34	22.05	2.38	23.30	2.43	
110	16.62	2.24	17.87	2.32	19.12	2.40	20.02	2.43	21.62	2.48	22.86	2.52		
115	16.18	2.32	17.43	2.40	18.68	2.49	19.58	2.52	21.18	2.57	22.43	2.62		
118	15.92	2.37	17.17	2.46	18.42	2.55	19.32	2.58	20.92	2.62	22.17	2.68		
122	15.83	2.44	17.08	2.53	18.33	2.62	19.23	2.65	20.83	2.70	22.08	2.75		

TC = Total Capacity (kBtu/h).

PI = Power Input (kW).

Nominal capacity as rated: 0 ft. above sea level with 25 ft. of refrigerant piping.  
0 ft. level difference between outdoor and indoor units.

Nominal cooling capacity rating obtained with air entering the indoor unit at 80°F dry bulb (DB) and 67°F wet bulb (WB), and outdoor ambient conditions of 95°F dry bulb (DB) and 75°F wet bulb (WB).

The shaded table rows indicate reference data. When operating at this temperature, these values can be different if the system is not running consistently.

# PERFORMANCE DATA

## Cooling Capacity Tables

MULTI F  
MULTI F MAX

Table 64: LMU369HV Cooling Capacity Table — Mixed Indoor Units (continued).

Connected Indoor Units	Combination Capacity Index	Outdoor Air Temp. (°F DB)	Indoor Air Temp. °F DB / °F WB											
			68 / 57		73 / 61		77 / 64		80 / 67		86 / 72		90 / 75	
			TC	PI	TC	PI	TC	PI	TC	PI	TC	PI	TC	PI
Two (2) Mixed Indoor Units	12 + 12	14	23.53	1.48	24.99	1.54	26.45	1.59	27.50	1.61	29.37	1.64	30.83	1.67
		20	23.51	1.50	24.97	1.56	26.43	1.62	27.48	1.63	29.35	1.67	30.81	1.70
		25	23.49	1.53	24.95	1.58	26.41	1.64	27.46	1.66	29.33	1.69	30.79	1.72
		30	23.47	1.55	24.93	1.60	26.39	1.66	27.44	1.68	29.30	1.71	30.76	1.75
		35	23.46	1.57	24.91	1.63	26.37	1.68	27.42	1.70	29.28	1.74	30.74	1.77
		40	23.44	1.59	24.89	1.65	26.35	1.71	27.40	1.73	29.26	1.76	30.72	1.80
		45	23.42	1.61	24.87	1.67	26.33	1.73	27.38	1.75	29.24	1.78	30.69	1.82
		50	23.40	1.63	24.85	1.69	26.31	1.75	27.36	1.77	29.21	1.81	30.67	1.84
		55	23.38	1.65	24.84	1.71	26.29	1.78	27.34	1.80	29.19	1.83	30.64	1.87
		60	23.37	1.67	24.82	1.74	26.27	1.80	27.32	1.82	29.17	1.85	30.62	1.89
		65	23.35	1.70	24.80	1.76	26.25	1.82	27.29	1.84	29.15	1.88	30.60	1.92
		70	23.33	1.72	24.78	1.78	26.23	1.85	27.27	1.87	29.13	1.90	30.57	1.94
		75	22.77	1.81	24.21	1.88	25.66	1.94	26.70	1.97	28.55	2.00	29.99	2.04
		80	22.21	1.90	23.65	1.97	25.09	2.04	26.13	2.07	27.97	2.11	29.42	2.15
		85	21.65	2.00	23.09	2.07	24.53	2.14	25.57	2.17	27.40	2.21	28.84	2.25
		90	21.09	2.09	22.53	2.16	23.96	2.24	25.00	2.27	26.83	2.31	28.27	2.36
		95	20.49	2.18	21.92	2.26	23.35	2.34	<b>24.00</b>	<b>2.37</b>	26.20	2.41	27.63	2.46
		100	19.99	2.27	21.42	2.36	22.85	2.44	23.69	2.47	25.70	2.52	27.13	2.57
		105	19.49	2.37	20.92	2.45	22.35	2.54	23.38	2.57	25.20	2.62	26.63	2.67
		110	18.99	2.46	20.42	2.55	21.85	2.64	22.88	2.67	24.70	2.72	26.13	2.78
		115	18.49	2.55	19.92	2.64	21.35	2.74	22.38	2.77	24.20	2.82	25.63	2.88
		118	18.19	2.61	19.62	2.70	21.05	2.80	22.08	2.83	23.90	2.89	25.33	2.94
	122	18.10	2.68	19.52	2.78	20.95	2.88	21.98	2.91	23.81	2.97	25.23	3.03	
	9 + 18	14	26.47	1.55	28.11	1.61	29.76	1.66	30.94	1.68	33.04	1.71	34.69	1.75
		20	26.45	1.57	28.09	1.63	29.73	1.69	30.92	1.71	33.02	1.74	34.66	1.77
		25	26.43	1.59	28.07	1.65	29.71	1.71	30.90	1.73	32.99	1.76	34.63	1.80
		30	26.41	1.62	28.05	1.67	29.69	1.74	30.87	1.76	32.97	1.79	34.61	1.82
		35	26.39	1.64	28.03	1.70	29.66	1.76	30.85	1.78	32.94	1.81	34.58	1.85
		40	26.37	1.66	28.00	1.72	29.64	1.78	30.82	1.80	32.92	1.84	34.55	1.87
		45	26.35	1.68	27.98	1.74	29.62	1.81	30.80	1.83	32.89	1.86	34.53	1.90
		50	26.33	1.70	27.96	1.77	29.60	1.83	30.78	1.85	32.87	1.89	34.50	1.93
		55	26.31	1.73	27.94	1.79	29.57	1.86	30.75	1.88	32.84	1.91	34.48	1.95
		60	26.29	1.75	27.92	1.81	29.55	1.88	30.73	1.90	32.82	1.94	34.45	1.98
		65	26.27	1.77	27.90	1.84	29.53	1.90	30.71	1.93	32.79	1.96	34.42	2.00
		70	26.25	1.79	27.88	1.86	29.51	1.93	30.68	1.95	32.77	1.99	34.40	2.03
		75	25.61	1.89	27.24	1.96	28.87	2.03	30.04	2.05	32.12	2.09	33.74	2.13
		80	24.98	1.99	26.60	2.06	28.23	2.13	29.40	2.16	31.47	2.20	33.09	2.24
		85	24.36	2.08	25.97	2.16	27.59	2.24	28.76	2.26	30.83	2.31	32.45	2.35
		90	23.73	2.18	25.34	2.26	26.96	2.34	28.12	2.37	30.19	2.41	31.80	2.46
		95	23.05	2.28	24.66	2.36	26.26	2.45	<b>27.00</b>	<b>2.48</b>	29.48	2.52	31.08	2.57
		100	22.49	2.37	24.10	2.46	25.70	2.55	26.65	2.58	28.91	2.63	30.52	2.68
		105	21.93	2.47	23.53	2.56	25.14	2.65	26.30	2.69	28.35	2.74	29.96	2.79
110		21.37	2.57	22.97	2.66	24.58	2.76	25.74	2.79	27.79	2.84	29.40	2.90	
115	20.81	2.66	22.41	2.76	24.02	2.86	25.18	2.90	27.23	2.95	28.84	3.01		
118	20.47	2.72	22.08	2.82	23.68	2.93	24.84	2.96	26.89	3.01	28.50	3.07		
122	20.36	2.80	21.96	2.90	23.57	3.01	24.73	3.04	26.78	3.10	28.39	3.16		

TC = Total Capacity (kBtu/h).

PI = Power Input (kW).

Nominal capacity as rated: 0 ft. above sea level with 25 ft. of refrigerant piping.  
0 ft. level difference between outdoor and indoor units.

Nominal cooling capacity rating obtained with air entering the indoor unit at 80°F dry bulb (DB) and 67°F wet bulb (WB), and outdoor ambient conditions of 95°F dry bulb (DB) and 75°F wet bulb (WB).

The shaded table rows indicate reference data. When operating at this temperature, these values can be different if the system is not running consistently.



Multi F and Multi F MAX Heat Pump System Engineering Manual

Table 65: LMU369HV Cooling Capacity Table — Mixed Indoor Units (continued).

Connected Indoor Units	Combination Capacity Index	Outdoor Air Temp. (°F DB)	Indoor Air Temp. °F DB / °F WB											
			68 / 57		73 / 61		77 / 64		80 / 67		86 / 72		90 / 75	
			TC	PI	TC	PI	TC	PI	TC	PI	TC	PI	TC	PI
Two (2) Mixed Indoor Units	12 + 18	14	29.41	1.66	31.24	1.72	33.06	1.79	34.38	1.81	36.71	1.84	38.54	1.88
		20	29.39	1.69	31.21	1.75	33.04	1.81	34.35	1.83	36.69	1.87	38.51	1.90
		25	29.36	1.71	31.19	1.77	33.01	1.84	34.33	1.86	36.66	1.89	38.48	1.93
		30	29.34	1.73	31.16	1.80	32.99	1.86	34.30	1.88	36.63	1.92	38.45	1.96
		35	29.32	1.76	31.14	1.82	32.96	1.89	34.28	1.91	36.60	1.95	38.42	1.98
		40	29.30	1.78	31.12	1.85	32.94	1.91	34.25	1.94	36.57	1.97	38.39	2.01
		45	29.27	1.80	31.09	1.87	32.91	1.94	34.22	1.96	36.55	2.00	38.36	2.04
		50	29.25	1.83	31.07	1.90	32.89	1.96	34.20	1.99	36.52	2.02	38.34	2.07
		55	29.23	1.85	31.04	1.92	32.86	1.99	34.17	2.01	36.49	2.05	38.31	2.09
		60	29.21	1.88	31.02	1.94	32.83	2.02	34.14	2.04	36.46	2.08	38.28	2.12
		65	29.18	1.90	31.00	1.97	32.81	2.04	34.12	2.07	36.43	2.10	38.25	2.15
		70	29.16	1.92	30.97	1.99	32.78	2.07	34.09	2.09	36.41	2.13	38.22	2.17
		75	28.46	2.03	30.27	2.10	32.07	2.18	33.38	2.20	35.69	2.25	37.49	2.29
		80	27.76	2.13	29.56	2.21	31.36	2.29	32.66	2.32	34.97	2.36	36.77	2.41
		85	27.06	2.24	28.86	2.32	30.66	2.40	31.96	2.43	34.25	2.47	36.05	2.52
		90	26.37	2.34	28.16	2.42	29.95	2.51	31.25	2.54	33.54	2.59	35.33	2.64
		95	25.61	2.44	27.40	2.53	29.18	2.62	<b>30.00</b>	<b>2.66</b>	32.75	2.70	34.53	2.76
		100	24.99	2.55	26.77	2.64	28.56	2.74	29.61	2.77	32.13	2.82	33.91	2.88
	105	24.37	2.65	26.15	2.75	27.93	2.85	29.22	2.88	31.50	2.93	33.29	2.99	
	110	23.74	2.75	25.53	2.86	27.31	2.96	28.60	2.99	30.88	3.05	32.66	3.11	
	115	23.12	2.86	24.90	2.96	26.69	3.07	27.98	3.11	30.26	3.16	32.04	3.23	
	118	22.74	2.92	24.53	3.03	26.31	3.14	27.60	3.17	29.88	3.23	31.67	3.30	
	122	22.62	3.00	24.40	3.11	26.19	3.23	27.48	3.26	29.76	3.33	31.54	3.39	
	14	32.35	1.84	34.36	1.91	36.37	1.98	37.82	2.00	40.39	2.04	42.40	2.08	
	20	32.33	1.87	34.33	1.93	36.34	2.01	37.79	2.03	40.36	2.07	42.36	2.11	
	25	32.30	1.89	34.31	1.96	36.31	2.03	37.76	2.06	40.32	2.10	42.33	2.14	
	30	32.28	1.92	34.28	1.99	36.28	2.06	37.73	2.09	40.29	2.12	42.30	2.17	
	35	32.25	1.95	34.25	2.02	36.26	2.09	37.70	2.11	40.26	2.15	42.27	2.20	
	40	32.23	1.97	34.23	2.04	36.23	2.12	37.67	2.14	40.23	2.18	42.23	2.23	
	45	32.20	2.00	34.20	2.07	36.20	2.15	37.65	2.17	40.20	2.21	42.20	2.26	
	50	32.18	2.02	34.18	2.10	36.17	2.18	37.62	2.20	40.17	2.24	42.17	2.29	
	55	32.15	2.05	34.15	2.13	36.15	2.20	37.59	2.23	40.14	2.27	42.14	2.32	
	60	32.13	2.08	34.12	2.15	36.12	2.23	37.56	2.26	40.11	2.30	42.10	2.35	
	65	32.10	2.10	34.10	2.18	36.09	2.26	37.53	2.29	40.08	2.33	42.07	2.38	
	70	32.08	2.13	34.07	2.21	36.06	2.29	37.50	2.32	40.05	2.36	42.04	2.41	
	75	31.31	2.25	33.29	2.33	35.28	2.41	36.72	2.44	39.26	2.49	41.24	2.54	
80	30.53	2.36	32.52	2.45	34.50	2.54	35.93	2.57	38.46	2.61	40.45	2.67		
85	29.77	2.48	31.75	2.57	33.72	2.66	35.15	2.69	37.68	2.74	39.66	2.80		
90	29.00	2.59	30.98	2.68	32.95	2.78	34.37	2.82	36.89	2.87	38.87	2.93		
95	28.17	2.71	30.14	2.80	32.10	2.91	<b>33.00</b>	<b>2.94</b>	36.03	3.00	37.99	3.06		
100	27.49	2.82	29.45	2.92	31.41	3.03	32.57	3.06	35.34	3.12	37.30	3.19		
105	26.80	2.94	28.76	3.04	30.73	3.15	32.14	3.19	34.65	3.25	36.62	3.31		
110	26.12	3.05	28.08	3.16	30.04	3.28	31.46	3.31	33.97	3.38	35.93	3.44		
115	25.43	3.17	27.39	3.28	29.36	3.40	30.77	3.44	33.28	3.50	35.24	3.57		
118	25.02	3.23	26.98	3.35	28.94	3.47	30.36	3.51	32.87	3.58	34.83	3.65		
122	24.88	3.33	26.84	3.45	28.81	3.57	30.22	3.61	32.73	3.68	34.69	3.76		

TC = Total Capacity (kBtu/h).

PI = Power Input (kW).

Nominal capacity as rated: 0 ft. above sea level with 25 ft. of refrigerant piping.  
0 ft. level difference between outdoor and indoor units.

Nominal cooling capacity rating obtained with air entering the indoor unit at 80°F dry bulb (DB) and 67°F wet bulb (WB), and outdoor ambient conditions of 95°F dry bulb (DB) and 75°F wet bulb (WB).

The shaded table rows indicate reference data. When operating at this temperature, these values can be different if the system is not running consistently.

# PERFORMANCE DATA

## Cooling Capacity Tables

MULTI F  
MULTI F MAX

Table 66: LMU369HV Cooling Capacity Table — Mixed Indoor Units (continued).

Connected Indoor Units	Combination Capacity Index	Outdoor Air Temp. (°F DB)	Indoor Air Temp. °F DB / °F WB											
			68 / 57		73 / 61		77 / 64		80 / 67		86 / 72		90 / 75	
			TC	PI	TC	PI	TC	PI	TC	PI	TC	PI	TC	PI
Two (2) Mixed Indoor Units	24 + 9	14	32.35	1.84	34.36	1.91	36.37	1.98	37.82	2.00	40.39	2.04	42.40	2.08
		20	32.33	1.87	34.33	1.93	36.34	2.01	37.79	2.03	40.36	2.07	42.36	2.11
		25	32.30	1.89	34.31	1.96	36.31	2.03	37.76	2.06	40.32	2.10	42.33	2.14
		30	32.28	1.92	34.28	1.99	36.28	2.06	37.73	2.09	40.29	2.12	42.30	2.17
		35	32.25	1.95	34.25	2.02	36.26	2.09	37.70	2.11	40.26	2.15	42.27	2.20
		40	32.23	1.97	34.23	2.04	36.23	2.12	37.67	2.14	40.23	2.18	42.23	2.23
		45	32.20	2.00	34.20	2.07	36.20	2.15	37.65	2.17	40.20	2.21	42.20	2.26
		50	32.18	2.02	34.18	2.10	36.17	2.18	37.62	2.20	40.17	2.24	42.17	2.29
		55	32.15	2.05	34.15	2.13	36.15	2.20	37.59	2.23	40.14	2.27	42.14	2.32
		60	32.13	2.08	34.12	2.15	36.12	2.23	37.56	2.26	40.11	2.30	42.10	2.35
		65	32.10	2.10	34.10	2.18	36.09	2.26	37.53	2.29	40.08	2.33	42.07	2.38
		70	32.08	2.13	34.07	2.21	36.06	2.29	37.50	2.32	40.05	2.36	42.04	2.41
		75	31.31	2.25	33.29	2.33	35.28	2.41	36.72	2.44	39.26	2.49	41.24	2.54
		80	30.53	2.36	32.52	2.45	34.50	2.54	35.93	2.57	38.46	2.61	40.45	2.67
		85	29.77	2.48	31.75	2.57	33.72	2.66	35.15	2.69	37.68	2.74	39.66	2.80
		90	29.00	2.59	30.98	2.68	32.95	2.78	34.37	2.82	36.89	2.87	38.87	2.93
		95	28.17	2.71	30.14	2.80	32.10	2.91	33.00	2.94	36.03	3.00	37.99	3.06
		100	27.49	2.82	29.45	2.92	31.41	3.03	32.57	3.06	35.34	3.12	37.30	3.19
		105	26.80	2.94	28.76	3.04	30.73	3.15	32.14	3.19	34.65	3.25	36.62	3.31
		110	26.12	3.05	28.08	3.16	30.04	3.28	31.46	3.31	33.97	3.38	35.93	3.44
		115	25.43	3.17	27.39	3.28	29.36	3.40	30.77	3.44	33.28	3.50	35.24	3.57
	118	25.02	3.23	26.98	3.35	28.94	3.47	30.36	3.51	32.87	3.58	34.83	3.65	
	122	24.88	3.33	26.84	3.45	28.81	3.57	30.22	3.61	32.73	3.68	34.69	3.76	
	24 + 12	14	32.35	1.84	34.36	1.91	36.37	1.98	37.82	2.00	40.39	2.04	42.40	2.08
		20	32.33	1.87	34.33	1.93	36.34	2.01	37.79	2.03	40.36	2.07	42.36	2.11
		25	32.30	1.89	34.31	1.96	36.31	2.03	37.76	2.06	40.32	2.10	42.33	2.14
		30	32.28	1.92	34.28	1.99	36.28	2.06	37.73	2.09	40.29	2.12	42.30	2.17
		35	32.25	1.95	34.25	2.02	36.26	2.09	37.70	2.11	40.26	2.15	42.27	2.20
		40	32.23	1.97	34.23	2.04	36.23	2.12	37.67	2.14	40.23	2.18	42.23	2.23
		45	32.20	2.00	34.20	2.07	36.20	2.15	37.65	2.17	40.20	2.21	42.20	2.26
		50	32.18	2.02	34.18	2.10	36.17	2.18	37.62	2.20	40.17	2.24	42.17	2.29
		55	32.15	2.05	34.15	2.13	36.15	2.20	37.59	2.23	40.14	2.27	42.14	2.32
		60	32.13	2.08	34.12	2.15	36.12	2.23	37.56	2.26	40.11	2.30	42.10	2.35
		65	32.10	2.10	34.10	2.18	36.09	2.26	37.53	2.29	40.08	2.33	42.07	2.38
		70	32.08	2.13	34.07	2.21	36.06	2.29	37.50	2.32	40.05	2.36	42.04	2.41
		75	31.31	2.25	33.29	2.33	35.28	2.41	36.72	2.44	39.26	2.49	41.24	2.54
		80	30.53	2.36	32.52	2.45	34.50	2.54	35.93	2.57	38.46	2.61	40.45	2.67
		85	29.77	2.48	31.75	2.57	33.72	2.66	35.15	2.69	37.68	2.74	39.66	2.80
		90	29.00	2.59	30.98	2.68	32.95	2.78	34.37	2.82	36.89	2.87	38.87	2.93
		95	28.17	2.71	30.14	2.80	32.10	2.91	33.00	2.94	36.03	3.00	37.99	3.06
		100	27.49	2.82	29.45	2.92	31.41	3.03	32.57	3.06	35.34	3.12	37.30	3.19
		105	26.80	2.94	28.76	3.04	30.73	3.15	32.14	3.19	34.65	3.25	36.62	3.31
110		26.12	3.05	28.08	3.16	30.04	3.28	31.46	3.31	33.97	3.38	35.93	3.44	
115		25.43	3.17	27.39	3.28	29.36	3.40	30.77	3.44	33.28	3.50	35.24	3.57	
118	25.02	3.23	26.98	3.35	28.94	3.47	30.36	3.51	32.87	3.58	34.83	3.65		
122	24.88	3.33	26.84	3.45	28.81	3.57	30.22	3.61	32.73	3.68	34.69	3.76		

TC = Total Capacity (kBtu/h).

PI = Power Input (kW).

Nominal capacity as rated: 0 ft. above sea level with 25 ft. of refrigerant piping.  
0 ft. level difference between outdoor and indoor units.

Nominal cooling capacity rating obtained with air entering the indoor unit at 80°F dry bulb (DB) and 67°F wet bulb (WB), and outdoor ambient conditions of 95°F dry bulb (DB) and 75°F wet bulb (WB).

The shaded table rows indicate reference data. When operating at this temperature, these values can be different if the system is not running consistently.



Multi F and Multi F MAX Heat Pump System Engineering Manual

Table 67: LMU369HV Cooling Capacity Table — Mixed Indoor Units (continued).

Connected Indoor Units	Combination Capacity Index	Outdoor Air Temp. (°F DB)	Indoor Air Temp. °F DB / °F WB											
			68 / 57		73 / 61		77 / 64		80 / 67		86 / 72		90 / 75	
			TC	PI	TC	PI	TC	PI	TC	PI	TC	PI	TC	PI
Three (3) Mixed Indoor Units	9 + 9 + 9	14	26.47	1.55	28.11	1.61	29.76	1.66	30.94	1.68	33.04	1.71	34.69	1.75
		20	26.45	1.57	28.09	1.63	29.73	1.69	30.92	1.71	33.02	1.74	34.66	1.77
		25	26.43	1.59	28.07	1.65	29.71	1.71	30.90	1.73	32.99	1.76	34.63	1.80
		30	26.41	1.62	28.05	1.67	29.69	1.74	30.87	1.76	32.97	1.79	34.61	1.82
		35	26.39	1.64	28.03	1.70	29.66	1.76	30.85	1.78	32.94	1.81	34.58	1.85
		40	26.37	1.66	28.00	1.72	29.64	1.78	30.82	1.80	32.92	1.84	34.55	1.87
		45	26.35	1.68	27.98	1.74	29.62	1.81	30.80	1.83	32.89	1.86	34.53	1.90
		50	26.33	1.70	27.96	1.77	29.60	1.83	30.78	1.85	32.87	1.89	34.50	1.93
		55	26.31	1.73	27.94	1.79	29.57	1.86	30.75	1.88	32.84	1.91	34.48	1.95
		60	26.29	1.75	27.92	1.81	29.55	1.88	30.73	1.90	32.82	1.94	34.45	1.98
		65	26.27	1.77	27.90	1.84	29.53	1.90	30.71	1.93	32.79	1.96	34.42	2.00
		70	26.25	1.79	27.88	1.86	29.51	1.93	30.68	1.95	32.77	1.99	34.40	2.03
		75	25.61	1.89	27.24	1.96	28.87	2.03	30.04	2.05	32.12	2.09	33.74	2.13
		80	24.98	1.99	26.60	2.06	28.23	2.13	29.40	2.16	31.47	2.20	33.09	2.24
		85	24.36	2.08	25.97	2.16	27.59	2.24	28.76	2.26	30.83	2.31	32.45	2.35
		90	23.73	2.18	25.34	2.26	26.96	2.34	28.12	2.37	30.19	2.41	31.80	2.46
		95	23.05	2.28	24.66	2.36	26.26	2.45	<b>27.00</b>	<b>2.48</b>	29.48	2.52	31.08	2.57
		100	22.49	2.37	24.10	2.46	25.70	2.55	26.65	2.58	28.91	2.63	30.52	2.68
	105	21.93	2.47	23.53	2.56	25.14	2.65	26.30	2.69	28.35	2.74	29.96	2.79	
	110	21.37	2.57	22.97	2.66	24.58	2.76	25.74	2.79	27.79	2.84	29.40	2.90	
	115	20.81	2.66	22.41	2.76	24.02	2.86	25.18	2.90	27.23	2.95	28.84	3.01	
	118	20.47	2.72	22.08	2.82	23.68	2.93	24.84	2.96	26.89	3.01	28.50	3.07	
	122	20.36	2.80	21.96	2.90	23.57	3.01	24.73	3.04	26.78	3.10	28.39	3.16	
	14	29.41	1.66	31.24	1.72	33.06	1.79	34.38	1.81	36.71	1.84	38.54	1.88	
	20	29.39	1.69	31.21	1.75	33.04	1.81	34.35	1.83	36.69	1.87	38.51	1.90	
	25	29.36	1.71	31.19	1.77	33.01	1.84	34.33	1.86	36.66	1.89	38.48	1.93	
	30	29.34	1.73	31.16	1.80	32.99	1.86	34.30	1.88	36.63	1.92	38.45	1.96	
	35	29.32	1.76	31.14	1.82	32.96	1.89	34.28	1.91	36.60	1.95	38.42	1.98	
	40	29.30	1.78	31.12	1.85	32.94	1.91	34.25	1.94	36.57	1.97	38.39	2.01	
	45	29.27	1.80	31.09	1.87	32.91	1.94	34.22	1.96	36.55	2.00	38.36	2.04	
	50	29.25	1.83	31.07	1.90	32.89	1.96	34.20	1.99	36.52	2.02	38.34	2.07	
	55	29.23	1.85	31.04	1.92	32.86	1.99	34.17	2.01	36.49	2.05	38.31	2.09	
	60	29.21	1.88	31.02	1.94	32.83	2.02	34.14	2.04	36.46	2.08	38.28	2.12	
	65	29.18	1.90	31.00	1.97	32.81	2.04	34.12	2.07	36.43	2.10	38.25	2.15	
	70	29.16	1.92	30.97	1.99	32.78	2.07	34.09	2.09	36.41	2.13	38.22	2.17	
	75	28.46	2.03	30.27	2.10	32.07	2.18	33.38	2.20	35.69	2.25	37.49	2.29	
80	27.76	2.13	29.56	2.21	31.36	2.29	32.66	2.32	34.97	2.36	36.77	2.41		
85	27.06	2.24	28.86	2.32	30.66	2.40	31.96	2.43	34.25	2.47	36.05	2.52		
90	26.37	2.34	28.16	2.42	29.95	2.51	31.25	2.54	33.54	2.59	35.33	2.64		
95	25.61	2.44	27.40	2.53	29.18	2.62	<b>30.00</b>	<b>2.66</b>	32.75	2.70	34.53	2.76		
100	24.99	2.55	26.77	2.64	28.56	2.74	29.61	2.77	32.13	2.82	33.91	2.88		
105	24.37	2.65	26.15	2.75	27.93	2.85	29.22	2.88	31.50	2.93	33.29	2.99		
110	23.74	2.75	25.53	2.86	27.31	2.96	28.60	2.99	30.88	3.05	32.66	3.11		
115	23.12	2.86	24.90	2.96	26.69	3.07	27.98	3.11	30.26	3.16	32.04	3.23		
118	22.74	2.92	24.53	3.03	26.31	3.14	27.60	3.17	29.88	3.23	31.67	3.30		
122	22.62	3.00	24.40	3.11	26.19	3.23	27.48	3.26	29.76	3.33	31.54	3.39		

TC = Total Capacity (kBtu/h).

PI = Power Input (kW).

Nominal capacity as rated: 0 ft. above sea level with 25 ft. of refrigerant piping.  
0 ft. level difference between outdoor and indoor units.

Nominal cooling capacity rating obtained with air entering the indoor unit at 80°F dry bulb (DB) and 67°F wet bulb (WB), and outdoor ambient conditions of 95°F dry bulb (DB) and 75°F wet bulb (WB).

The shaded table rows indicate reference data. When operating at this temperature, these values can be different if the system is not running consistently.

# PERFORMANCE DATA

## Cooling Capacity Tables

MULTI F  
MULTI F MAX

Table 68: LMU369HV Cooling Capacity Table — Mixed Indoor Units (continued).

Connected Indoor Units	Combination Capacity Index	Outdoor Air Temp. (°F DB)	Indoor Air Temp. °F DB / °F WB											
			68 / 57		73 / 61		77 / 64		80 / 67		86 / 72		90 / 75	
			TC	PI	TC	PI	TC	PI	TC	PI	TC	PI	TC	PI
Three (3) Mixed Indoor Units	9 + 12 + 12	14	32.35	1.75	34.36	1.82	36.37	1.88	37.82	1.90	40.39	1.94	42.40	1.98
		20	32.33	1.78	34.33	1.84	36.34	1.91	37.79	1.93	40.36	1.97	42.36	2.01
		25	32.30	1.80	34.31	1.87	36.31	1.94	37.76	1.96	40.32	2.00	42.33	2.04
		30	32.28	1.83	34.28	1.89	36.28	1.96	37.73	1.99	40.29	2.02	42.30	2.06
		35	32.25	1.85	34.25	1.92	36.26	1.99	37.70	2.01	40.26	2.05	42.27	2.09
		40	32.23	1.88	34.23	1.95	36.23	2.02	37.67	2.04	40.23	2.08	42.23	2.12
		45	32.20	1.90	34.20	1.97	36.20	2.04	37.65	2.07	40.20	2.11	42.20	2.15
		50	32.18	1.93	34.18	2.00	36.17	2.07	37.62	2.10	40.17	2.13	42.17	2.18
		55	32.15	1.95	34.15	2.02	36.15	2.10	37.59	2.12	40.14	2.16	42.14	2.21
		60	32.13	1.98	34.12	2.05	36.12	2.13	37.56	2.15	40.11	2.19	42.10	2.23
		65	32.10	2.00	34.10	2.08	36.09	2.15	37.53	2.18	40.08	2.22	42.07	2.26
		70	32.08	2.03	34.07	2.10	36.06	2.18	37.50	2.21	40.05	2.25	42.04	2.29
		75	31.31	2.14	33.29	2.22	35.28	2.30	36.72	2.32	39.26	2.37	41.24	2.42
		80	30.53	2.25	32.52	2.33	34.50	2.42	35.93	2.44	38.46	2.49	40.45	2.54
		85	29.77	2.36	31.75	2.44	33.72	2.53	35.15	2.56	37.68	2.61	39.66	2.66
		90	29.00	2.47	30.98	2.56	32.95	2.65	34.37	2.68	36.89	2.73	38.87	2.79
		95	28.17	2.58	30.14	2.67	32.10	2.77	<b>33.00</b>	<b>2.80</b>	36.03	2.85	37.99	2.91
		100	27.49	2.69	29.45	2.78	31.41	2.89	32.57	2.92	35.34	2.97	37.30	3.03
	105	26.80	2.80	28.76	2.90	30.73	3.00	32.14	3.04	34.65	3.09	36.62	3.16	
	110	26.12	2.90	28.08	3.01	30.04	3.12	31.46	3.16	33.97	3.22	35.93	3.28	
	115	25.43	3.01	27.39	3.12	29.36	3.24	30.77	3.28	33.28	3.34	35.24	3.40	
	118	25.02	3.08	26.98	3.19	28.94	3.31	30.36	3.35	32.87	3.41	34.83	3.48	
	122	24.88	3.17	26.84	3.28	28.81	3.40	30.22	3.44	32.73	3.51	34.69	3.58	
	12 + 12 + 12	14	33.33	1.74	35.40	1.80	37.47	1.87	38.96	1.89	41.61	1.93	43.68	1.96
		20	33.30	1.76	35.37	1.83	37.44	1.90	38.94	1.92	41.58	1.95	43.65	1.99
		25	33.28	1.79	35.35	1.86	37.41	1.92	38.91	1.94	41.55	1.98	43.61	2.02
		30	33.25	1.81	35.32	1.88	37.38	1.95	38.88	1.97	41.51	2.01	43.58	2.05
		35	33.23	1.84	35.29	1.91	37.36	1.98	38.85	2.00	41.48	2.04	43.55	2.08
		40	33.20	1.86	35.27	1.93	37.33	2.00	38.82	2.03	41.45	2.06	43.51	2.11
		45	33.18	1.89	35.24	1.96	37.30	2.03	38.79	2.05	41.42	2.09	43.48	2.13
		50	33.15	1.91	35.21	1.98	37.27	2.06	38.76	2.08	41.39	2.12	43.45	2.16
		55	33.13	1.94	35.18	2.01	37.24	2.08	38.73	2.11	41.36	2.15	43.41	2.19
		60	33.10	1.96	35.16	2.04	37.21	2.11	38.70	2.14	41.32	2.18	43.38	2.22
		65	33.08	1.99	35.13	2.06	37.18	2.14	38.67	2.16	41.29	2.20	43.35	2.25
		70	33.05	2.01	35.10	2.09	37.16	2.16	38.64	2.19	41.26	2.23	43.31	2.28
		75	32.26	2.12	34.30	2.20	36.35	2.28	37.83	2.31	40.45	2.35	42.49	2.40
80		31.46	2.23	33.50	2.31	35.54	2.40	37.02	2.43	39.63	2.47	41.67	2.52	
85		30.67	2.34	32.71	2.43	34.75	2.51	36.22	2.54	38.82	2.59	40.86	2.64	
90		29.88	2.45	31.92	2.54	33.95	2.63	35.42	2.66	38.01	2.71	40.05	2.77	
95		29.03	2.56	31.05	2.65	33.07	2.75	<b>34.00</b>	<b>2.78</b>	37.12	2.83	39.14	2.89	
100		28.32	2.67	30.34	2.76	32.37	2.87	33.56	2.90	36.41	2.95	38.43	3.01	
105	27.61	2.78	29.64	2.88	31.66	2.98	33.12	3.02	35.70	3.07	37.73	3.13		
110	26.91	2.88	28.93	2.99	30.95	3.10	32.41	3.13	35.00	3.19	37.02	3.26		
115	26.20	2.99	28.22	3.10	30.24	3.22	31.71	3.25	34.29	3.31	36.31	3.38		
118	25.78	3.06	27.80	3.17	29.82	3.29	31.28	3.32	33.87	3.39	35.89	3.45		
122	25.63	3.15	27.66	3.26	29.68	3.38	31.14	3.42	33.72	3.48	35.75	3.55		

TC = Total Capacity (kBtu/h).

PI = Power Input (kW).

Nominal capacity as rated: 0 ft. above sea level with 25 ft. of refrigerant piping.  
0 ft. level difference between outdoor and indoor units.

Nominal cooling capacity rating obtained with air entering the indoor unit at 80°F dry bulb (DB) and 67°F wet bulb (WB), and outdoor ambient conditions of 95°F dry bulb (DB) and 75°F wet bulb (WB).

The shaded table rows indicate reference data. When operating at this temperature, these values can be different if the system is not running consistently.



Multi F and Multi F MAX Heat Pump System Engineering Manual

Table 69: LMU369HV Cooling Capacity Table — Mixed Indoor Units (continued).

Connected Indoor Units	Combination Capacity Index	Outdoor Air Temp. (°F DB)	Indoor Air Temp. °F DB / °F WB											
			68 / 57		73 / 61		77 / 64		80 / 67		86 / 72		90 / 75	
			TC	PI	TC	PI	TC	PI	TC	PI	TC	PI	TC	PI
Three (3) Mixed Indoor Units	9 + 9 + 18	14	33.33	1.74	35.40	1.80	37.47	1.87	38.96	1.89	41.61	1.93	43.68	1.96
		20	33.30	1.76	35.37	1.83	37.44	1.90	38.94	1.92	41.58	1.95	43.65	1.99
		25	33.28	1.79	35.35	1.86	37.41	1.92	38.91	1.94	41.55	1.98	43.61	2.02
		30	33.25	1.81	35.32	1.88	37.38	1.95	38.88	1.97	41.51	2.01	43.58	2.05
		35	33.23	1.84	35.29	1.91	37.36	1.98	38.85	2.00	41.48	2.04	43.55	2.08
		40	33.20	1.86	35.27	1.93	37.33	2.00	38.82	2.03	41.45	2.06	43.51	2.11
		45	33.18	1.89	35.24	1.96	37.30	2.03	38.79	2.05	41.42	2.09	43.48	2.13
		50	33.15	1.91	35.21	1.98	37.27	2.06	38.76	2.08	41.39	2.12	43.45	2.16
		55	33.13	1.94	35.18	2.01	37.24	2.08	38.73	2.11	41.36	2.15	43.41	2.19
		60	33.10	1.96	35.16	2.04	37.21	2.11	38.70	2.14	41.32	2.18	43.38	2.22
		65	33.08	1.99	35.13	2.06	37.18	2.14	38.67	2.16	41.29	2.20	43.35	2.25
		70	33.05	2.01	35.10	2.09	37.16	2.16	38.64	2.19	41.26	2.23	43.31	2.28
		75	32.26	2.12	34.30	2.20	36.35	2.28	37.83	2.31	40.45	2.35	42.49	2.40
		80	31.46	2.23	33.50	2.31	35.54	2.40	37.02	2.43	39.63	2.47	41.67	2.52
		85	30.67	2.34	32.71	2.43	34.75	2.51	36.22	2.54	38.82	2.59	40.86	2.64
		90	29.88	2.45	31.92	2.54	33.95	2.63	35.42	2.66	38.01	2.71	40.05	2.77
		95	29.03	2.56	31.05	2.65	33.07	2.75	34.00	2.78	37.12	2.83	39.14	2.89
		100	28.32	2.67	30.34	2.76	32.37	2.87	33.56	2.90	36.41	2.95	38.43	3.01
		105	27.61	2.78	29.64	2.88	31.66	2.98	33.12	3.02	35.70	3.07	37.73	3.13
		110	26.91	2.88	28.93	2.99	30.95	3.10	32.41	3.13	35.00	3.19	37.02	3.26
		115	26.20	2.99	28.22	3.10	30.24	3.22	31.71	3.25	34.29	3.31	36.31	3.38
		118	25.78	3.06	27.80	3.17	29.82	3.29	31.28	3.32	33.87	3.39	35.89	3.45
	122	25.63	3.15	27.66	3.26	29.68	3.38	31.14	3.42	33.72	3.48	35.75	3.55	
	9 + 12 + 18	14	33.33	1.74	35.40	1.80	37.47	1.87	38.96	1.89	41.61	1.93	43.68	1.96
		20	33.30	1.76	35.37	1.83	37.44	1.90	38.94	1.92	41.58	1.95	43.65	1.99
		25	33.28	1.79	35.35	1.86	37.41	1.92	38.91	1.94	41.55	1.98	43.61	2.02
		30	33.25	1.81	35.32	1.88	37.38	1.95	38.88	1.97	41.51	2.01	43.58	2.05
		35	33.23	1.84	35.29	1.91	37.36	1.98	38.85	2.00	41.48	2.04	43.55	2.08
		40	33.20	1.86	35.27	1.93	37.33	2.00	38.82	2.03	41.45	2.06	43.51	2.11
		45	33.18	1.89	35.24	1.96	37.30	2.03	38.79	2.05	41.42	2.09	43.48	2.13
		50	33.15	1.91	35.21	1.98	37.27	2.06	38.76	2.08	41.39	2.12	43.45	2.16
		55	33.13	1.94	35.18	2.01	37.24	2.08	38.73	2.11	41.36	2.15	43.41	2.19
		60	33.10	1.96	35.16	2.04	37.21	2.11	38.70	2.14	41.32	2.18	43.38	2.22
		65	33.08	1.99	35.13	2.06	37.18	2.14	38.67	2.16	41.29	2.20	43.35	2.25
		70	33.05	2.01	35.10	2.09	37.16	2.16	38.64	2.19	41.26	2.23	43.31	2.28
		75	32.26	2.12	34.30	2.20	36.35	2.28	37.83	2.31	40.45	2.35	42.49	2.40
		80	31.46	2.23	33.50	2.31	35.54	2.40	37.02	2.43	39.63	2.47	41.67	2.52
		85	30.67	2.34	32.71	2.43	34.75	2.51	36.22	2.54	38.82	2.59	40.86	2.64
		90	29.88	2.45	31.92	2.54	33.95	2.63	35.42	2.66	38.01	2.71	40.05	2.77
		95	29.03	2.56	31.05	2.65	33.07	2.75	34.00	2.78	37.12	2.83	39.14	2.89
		100	28.32	2.67	30.34	2.76	32.37	2.87	33.56	2.90	36.41	2.95	38.43	3.01
		105	27.61	2.78	29.64	2.88	31.66	2.98	33.12	3.02	35.70	3.07	37.73	3.13
110		26.91	2.88	28.93	2.99	30.95	3.10	32.41	3.13	35.00	3.19	37.02	3.26	
115		26.20	2.99	28.22	3.10	30.24	3.22	31.71	3.25	34.29	3.31	36.31	3.38	
118		25.78	3.06	27.80	3.17	29.82	3.29	31.28	3.32	33.87	3.39	35.89	3.45	
122	25.63	3.15	27.66	3.26	29.68	3.38	31.14	3.42	33.72	3.48	35.75	3.55		

TC = Total Capacity (kBtu/h).

PI = Power Input (kW).

Nominal capacity as rated: 0 ft. above sea level with 25 ft. of refrigerant piping.  
0 ft. level difference between outdoor and indoor units.

Nominal cooling capacity rating obtained with air entering the indoor unit at 80°F dry bulb (DB) and 67°F wet bulb (WB), and outdoor ambient conditions of 95°F dry bulb (DB) and 75°F wet bulb (WB).

The shaded table rows indicate reference data. When operating at this temperature, these values can be different if the system is not running consistently.

# PERFORMANCE DATA

## Cooling Capacity Tables

MULTI F  
MULTI F MAX

Table 70: LMU369HV Cooling Capacity Table — Mixed Indoor Units (continued).

Connected Indoor Units	Combination Capacity Index	Outdoor Air Temp. (°F DB)	Indoor Air Temp. °F DB / °F WB											
			68 / 57		73 / 61		77 / 64		80 / 67		86 / 72		90 / 75	
			TC	PI	TC	PI	TC	PI	TC	PI	TC	PI	TC	PI
Three (3) Mixed Indoor Units	12 + 12 + 18	14	33.33	1.74	35.40	1.80	37.47	1.87	38.96	1.89	41.61	1.93	43.68	1.96
		20	33.30	1.76	35.37	1.83	37.44	1.90	38.94	1.92	41.58	1.95	43.65	1.99
		25	33.28	1.79	35.35	1.86	37.41	1.92	38.91	1.94	41.55	1.98	43.61	2.02
		30	33.25	1.81	35.32	1.88	37.38	1.95	38.88	1.97	41.51	2.01	43.58	2.05
		35	33.23	1.84	35.29	1.91	37.36	1.98	38.85	2.00	41.48	2.04	43.55	2.08
		40	33.20	1.86	35.27	1.93	37.33	2.00	38.82	2.03	41.45	2.06	43.51	2.11
		45	33.18	1.89	35.24	1.96	37.30	2.03	38.79	2.05	41.42	2.09	43.48	2.13
		50	33.15	1.91	35.21	1.98	37.27	2.06	38.76	2.08	41.39	2.12	43.45	2.16
		55	33.13	1.94	35.18	2.01	37.24	2.08	38.73	2.11	41.36	2.15	43.41	2.19
		60	33.10	1.96	35.16	2.04	37.21	2.11	38.70	2.14	41.32	2.18	43.38	2.22
		65	33.08	1.99	35.13	2.06	37.18	2.14	38.67	2.16	41.29	2.20	43.35	2.25
		70	33.05	2.01	35.10	2.09	37.16	2.16	38.64	2.19	41.26	2.23	43.31	2.28
	75	32.26	2.12	34.30	2.20	36.35	2.28	37.83	2.31	40.45	2.35	42.49	2.40	
	80	31.46	2.23	33.50	2.31	35.54	2.40	37.02	2.43	39.63	2.47	41.67	2.52	
	85	30.67	2.34	32.71	2.43	34.75	2.51	36.22	2.54	38.82	2.59	40.86	2.64	
	90	29.88	2.45	31.92	2.54	33.95	2.63	35.42	2.66	38.01	2.71	40.05	2.77	
	95	29.03	2.56	31.05	2.65	33.07	2.75	<b>34.00</b>	<b>2.78</b>	37.12	2.83	39.14	2.89	
	100	28.32	2.67	30.34	2.76	32.37	2.87	33.56	2.90	36.41	2.95	38.43	3.01	
	105	27.61	2.78	29.64	2.88	31.66	2.98	33.12	3.02	35.70	3.07	37.73	3.13	
	110	26.91	2.88	28.93	2.99	30.95	3.10	32.41	3.13	35.00	3.19	37.02	3.26	
	115	26.20	2.99	28.22	3.10	30.24	3.22	31.71	3.25	34.29	3.31	36.31	3.38	
	118	25.78	3.06	27.80	3.17	29.82	3.29	31.28	3.32	33.87	3.39	35.89	3.45	
	122	25.63	3.15	27.66	3.26	29.68	3.38	31.14	3.42	33.72	3.48	35.75	3.55	
	9 + 18 + 18	14	33.33	1.74	35.40	1.80	37.47	1.87	38.96	1.89	41.61	1.93	43.68	1.96
20		33.30	1.76	35.37	1.83	37.44	1.90	38.94	1.92	41.58	1.95	43.65	1.99	
25		33.28	1.79	35.35	1.86	37.41	1.92	38.91	1.94	41.55	1.98	43.61	2.02	
30		33.25	1.81	35.32	1.88	37.38	1.95	38.88	1.97	41.51	2.01	43.58	2.05	
35		33.23	1.84	35.29	1.91	37.36	1.98	38.85	2.00	41.48	2.04	43.55	2.08	
40		33.20	1.86	35.27	1.93	37.33	2.00	38.82	2.03	41.45	2.06	43.51	2.11	
45		33.18	1.89	35.24	1.96	37.30	2.03	38.79	2.05	41.42	2.09	43.48	2.13	
50		33.15	1.91	35.21	1.98	37.27	2.06	38.76	2.08	41.39	2.12	43.45	2.16	
55		33.13	1.94	35.18	2.01	37.24	2.08	38.73	2.11	41.36	2.15	43.41	2.19	
60		33.10	1.96	35.16	2.04	37.21	2.11	38.70	2.14	41.32	2.18	43.38	2.22	
65		33.08	1.99	35.13	2.06	37.18	2.14	38.67	2.16	41.29	2.20	43.35	2.25	
70		33.05	2.01	35.10	2.09	37.16	2.16	38.64	2.19	41.26	2.23	43.31	2.28	
75	32.26	2.12	34.30	2.20	36.35	2.28	37.83	2.31	40.45	2.35	42.49	2.40		
80	31.46	2.23	33.50	2.31	35.54	2.40	37.02	2.43	39.63	2.47	41.67	2.52		
85	30.67	2.34	32.71	2.43	34.75	2.51	36.22	2.54	38.82	2.59	40.86	2.64		
90	29.88	2.45	31.92	2.54	33.95	2.63	35.42	2.66	38.01	2.71	40.05	2.77		
95	29.03	2.56	31.05	2.65	33.07	2.75	<b>34.00</b>	<b>2.78</b>	37.12	2.83	39.14	2.89		
100	28.32	2.67	30.34	2.76	32.37	2.87	33.56	2.90	36.41	2.95	38.43	3.01		
105	27.61	2.78	29.64	2.88	31.66	2.98	33.12	3.02	35.70	3.07	37.73	3.13		
110	26.91	2.88	28.93	2.99	30.95	3.10	32.41	3.13	35.00	3.19	37.02	3.26		
115	26.20	2.99	28.22	3.10	30.24	3.22	31.71	3.25	34.29	3.31	36.31	3.38		
118	25.78	3.06	27.80	3.17	29.82	3.29	31.28	3.32	33.87	3.39	35.89	3.45		
122	25.63	3.15	27.66	3.26	29.68	3.38	31.14	3.42	33.72	3.48	35.75	3.55		

TC = Total Capacity (kBtu/h).

PI = Power Input (kW).

Nominal capacity as rated: 0 ft. above sea level with 25 ft. of refrigerant piping.  
0 ft. level difference between outdoor and indoor units.

Nominal cooling capacity rating obtained with air entering the indoor unit at 80°F dry bulb (DB) and 67°F wet bulb (WB), and outdoor ambient conditions of 95°F dry bulb (DB) and 75°F wet bulb (WB).

The shaded table columns and rows indicate reference data. When operating at this temperature, these values can be different if the system is not running consistently.



Multi F and Multi F MAX Heat Pump System Engineering Manual

Table 71: LMU369HV Cooling Capacity Table — Mixed Indoor Units (continued).

Connected Indoor Units	Combination Capacity Index	Outdoor Air Temp. (°F DB)	Indoor Air Temp. °F DB / °F WB											
			68 / 57		73 / 61		77 / 64		80 / 67		86 / 72		90 / 75	
			TC	PI	TC	PI	TC	PI	TC	PI	TC	PI	TC	PI
Three (3) Mixed Indoor Units	12 + 18 + 18	14	33.33	1.74	35.40	1.80	37.47	1.87	38.96	1.89	41.61	1.93	43.68	1.96
		20	33.30	1.76	35.37	1.83	37.44	1.90	38.94	1.92	41.58	1.95	43.65	1.99
		25	33.28	1.79	35.35	1.86	37.41	1.92	38.91	1.94	41.55	1.98	43.61	2.02
		30	33.25	1.81	35.32	1.88	37.38	1.95	38.88	1.97	41.51	2.01	43.58	2.05
		35	33.23	1.84	35.29	1.91	37.36	1.98	38.85	2.00	41.48	2.04	43.55	2.08
		40	33.20	1.86	35.27	1.93	37.33	2.00	38.82	2.03	41.45	2.06	43.51	2.11
		45	33.18	1.89	35.24	1.96	37.30	2.03	38.79	2.05	41.42	2.09	43.48	2.13
		50	33.15	1.91	35.21	1.98	37.27	2.06	38.76	2.08	41.39	2.12	43.45	2.16
		55	33.13	1.94	35.18	2.01	37.24	2.08	38.73	2.11	41.36	2.15	43.41	2.19
		60	33.10	1.96	35.16	2.04	37.21	2.11	38.70	2.14	41.32	2.18	43.38	2.22
		65	33.08	1.99	35.13	2.06	37.18	2.14	38.67	2.16	41.29	2.20	43.35	2.25
		70	33.05	2.01	35.10	2.09	37.16	2.16	38.64	2.19	41.26	2.23	43.31	2.28
		75	32.26	2.12	34.30	2.20	36.35	2.28	37.83	2.31	40.45	2.35	42.49	2.40
		80	31.46	2.23	33.50	2.31	35.54	2.40	37.02	2.43	39.63	2.47	41.67	2.52
		85	30.67	2.34	32.71	2.43	34.75	2.51	36.22	2.54	38.82	2.59	40.86	2.64
		90	29.88	2.45	31.92	2.54	33.95	2.63	35.42	2.66	38.01	2.71	40.05	2.77
		95	29.03	2.56	31.05	2.65	33.07	2.75	<b>34.00</b>	<b>2.78</b>	37.12	2.83	39.14	2.89
		100	28.32	2.67	30.34	2.76	32.37	2.87	33.56	2.90	36.41	2.95	38.43	3.01
105	27.61	2.78	29.64	2.88	31.66	2.98	33.12	3.02	35.70	3.07	37.73	3.13		
110	26.91	2.88	28.93	2.99	30.95	3.10	32.41	3.13	35.00	3.19	37.02	3.26		
115	26.20	2.99	28.22	3.10	30.24	3.22	31.71	3.25	34.29	3.31	36.31	3.38		
118	25.78	3.06	27.80	3.17	29.82	3.29	31.28	3.32	33.87	3.39	35.89	3.45		
122	25.63	3.15	27.66	3.26	29.68	3.38	31.14	3.42	33.72	3.48	35.75	3.55		
Four (4) Mixed Indoor Units	9 + 9 + 9 + 9	14	33.33	1.74	35.40	1.80	37.47	1.87	38.96	1.89	41.61	1.93	43.68	1.96
		20	33.30	1.76	35.37	1.83	37.44	1.90	38.94	1.92	41.58	1.95	43.65	1.99
		25	33.28	1.79	35.35	1.86	37.41	1.92	38.91	1.94	41.55	1.98	43.61	2.02
		30	33.25	1.81	35.32	1.88	37.38	1.95	38.88	1.97	41.51	2.01	43.58	2.05
		35	33.23	1.84	35.29	1.91	37.36	1.98	38.85	2.00	41.48	2.04	43.55	2.08
		40	33.20	1.86	35.27	1.93	37.33	2.00	38.82	2.03	41.45	2.06	43.51	2.11
		45	33.18	1.89	35.24	1.96	37.30	2.03	38.79	2.05	41.42	2.09	43.48	2.13
		50	33.15	1.91	35.21	1.98	37.27	2.06	38.76	2.08	41.39	2.12	43.45	2.16
		55	33.13	1.94	35.18	2.01	37.24	2.08	38.73	2.11	41.36	2.15	43.41	2.19
		60	33.10	1.96	35.16	2.04	37.21	2.11	38.70	2.14	41.32	2.18	43.38	2.22
		65	33.08	1.99	35.13	2.06	37.18	2.14	38.67	2.16	41.29	2.20	43.35	2.25
		70	33.05	2.01	35.10	2.09	37.16	2.16	38.64	2.19	41.26	2.23	43.31	2.28
		75	32.26	2.12	34.30	2.20	36.35	2.28	37.83	2.31	40.45	2.35	42.49	2.40
		80	31.46	2.23	33.50	2.31	35.54	2.40	37.02	2.43	39.63	2.47	41.67	2.52
		85	30.67	2.34	32.71	2.43	34.75	2.51	36.22	2.54	38.82	2.59	40.86	2.64
		90	29.88	2.45	31.92	2.54	33.95	2.63	35.42	2.66	38.01	2.71	40.05	2.77
		95	29.03	2.56	31.05	2.65	33.07	2.75	<b>34.00</b>	<b>2.78</b>	37.12	2.83	39.14	2.89
		100	28.32	2.67	30.34	2.76	32.37	2.87	33.56	2.90	36.41	2.95	38.43	3.01
105	27.61	2.78	29.64	2.88	31.66	2.98	33.12	3.02	35.70	3.07	37.73	3.13		
110	26.91	2.88	28.93	2.99	30.95	3.10	32.41	3.13	35.00	3.19	37.02	3.26		
115	26.20	2.99	28.22	3.10	30.24	3.22	31.71	3.25	34.29	3.31	36.31	3.38		
118	25.78	3.06	27.80	3.17	29.82	3.29	31.28	3.32	33.87	3.39	35.89	3.45		
122	25.63	3.15	27.66	3.26	29.68	3.38	31.14	3.42	33.72	3.48	35.75	3.55		

TC = Total Capacity (kBtu/h).

PI = Power Input (kW).

Nominal capacity as rated: 0 ft. above sea level with 25 ft. of refrigerant piping.  
0 ft. level difference between outdoor and indoor units.

Nominal cooling capacity rating obtained with air entering the indoor unit at 80°F dry bulb (DB) and 67°F wet bulb (WB), and outdoor ambient conditions of 95°F dry bulb (DB) and 75°F wet bulb (WB).

The shaded table columns and rows indicate reference data. When operating at this temperature, these values can be different if the system is not running consistently.

# PERFORMANCE DATA

## Cooling Capacity Tables

MULTI F  
MULTI F MAX

Table 72: LMU369HV Cooling Capacity Table — Mixed Indoor Units (continued).

Connected Indoor Units	Combination Capacity Index	Outdoor Air Temp. (°F DB)	Indoor Air Temp. °F DB / °F WB											
			68 / 57		73 / 61		77 / 64		80 / 67		86 / 72		90 / 75	
			TC	PI	TC	PI	TC	PI	TC	PI	TC	PI	TC	PI
Four (4) Mixed Indoor Units	9 + 9 + 9 + 12	14	33.33	1.74	35.40	1.80	37.47	1.87	38.96	1.89	41.61	1.93	43.68	1.96
		20	33.30	1.76	35.37	1.83	37.44	1.90	38.94	1.92	41.58	1.95	43.65	1.99
		25	33.28	1.79	35.35	1.86	37.41	1.92	38.91	1.94	41.55	1.98	43.61	2.02
		30	33.25	1.81	35.32	1.88	37.38	1.95	38.88	1.97	41.51	2.01	43.58	2.05
		35	33.23	1.84	35.29	1.91	37.36	1.98	38.85	2.00	41.48	2.04	43.55	2.08
		40	33.20	1.86	35.27	1.93	37.33	2.00	38.82	2.03	41.45	2.06	43.51	2.11
		45	33.18	1.89	35.24	1.96	37.30	2.03	38.79	2.05	41.42	2.09	43.48	2.13
		50	33.15	1.91	35.21	1.98	37.27	2.06	38.76	2.08	41.39	2.12	43.45	2.16
		55	33.13	1.94	35.18	2.01	37.24	2.08	38.73	2.11	41.36	2.15	43.41	2.19
		60	33.10	1.96	35.16	2.04	37.21	2.11	38.70	2.14	41.32	2.18	43.38	2.22
		65	33.08	1.99	35.13	2.06	37.18	2.14	38.67	2.16	41.29	2.20	43.35	2.25
		70	33.05	2.01	35.10	2.09	37.16	2.16	38.64	2.19	41.26	2.23	43.31	2.28
		75	32.26	2.12	34.30	2.20	36.35	2.28	37.83	2.31	40.45	2.35	42.49	2.40
		80	31.46	2.23	33.50	2.31	35.54	2.40	37.02	2.43	39.63	2.47	41.67	2.52
		85	30.67	2.34	32.71	2.43	34.75	2.51	36.22	2.54	38.82	2.59	40.86	2.64
		90	29.88	2.45	31.92	2.54	33.95	2.63	35.42	2.66	38.01	2.71	40.05	2.77
		95	29.03	2.56	31.05	2.65	33.07	2.75	<b>34.00</b>	<b>2.78</b>	37.12	2.83	39.14	2.89
		100	28.32	2.67	30.34	2.76	32.37	2.87	33.56	2.90	36.41	2.95	38.43	3.01
		105	27.61	2.78	29.64	2.88	31.66	2.98	33.12	3.02	35.70	3.07	37.73	3.13
		110	26.91	2.88	28.93	2.99	30.95	3.10	32.41	3.13	35.00	3.19	37.02	3.26
		115	26.20	2.99	28.22	3.10	30.24	3.22	31.71	3.25	34.29	3.31	36.31	3.38
	118	25.78	3.06	27.80	3.17	29.82	3.29	31.28	3.32	33.87	3.39	35.89	3.45	
	122	25.63	3.15	27.66	3.26	29.68	3.38	31.14	3.42	33.72	3.48	35.75	3.55	
	9 + 9 + 12 + 12	14	33.33	1.74	35.40	1.80	37.47	1.87	38.96	1.89	41.61	1.93	43.68	1.96
		20	33.30	1.76	35.37	1.83	37.44	1.90	38.94	1.92	41.58	1.95	43.65	1.99
		25	33.28	1.79	35.35	1.86	37.41	1.92	38.91	1.94	41.55	1.98	43.61	2.02
		30	33.25	1.81	35.32	1.88	37.38	1.95	38.88	1.97	41.51	2.01	43.58	2.05
		35	33.23	1.84	35.29	1.91	37.36	1.98	38.85	2.00	41.48	2.04	43.55	2.08
		40	33.20	1.86	35.27	1.93	37.33	2.00	38.82	2.03	41.45	2.06	43.51	2.11
		45	33.18	1.89	35.24	1.96	37.30	2.03	38.79	2.05	41.42	2.09	43.48	2.13
		50	33.15	1.91	35.21	1.98	37.27	2.06	38.76	2.08	41.39	2.12	43.45	2.16
		55	33.13	1.94	35.18	2.01	37.24	2.08	38.73	2.11	41.36	2.15	43.41	2.19
		60	33.10	1.96	35.16	2.04	37.21	2.11	38.70	2.14	41.32	2.18	43.38	2.22
		65	33.08	1.99	35.13	2.06	37.18	2.14	38.67	2.16	41.29	2.20	43.35	2.25
		70	33.05	2.01	35.10	2.09	37.16	2.16	38.64	2.19	41.26	2.23	43.31	2.28
		75	32.26	2.12	34.30	2.20	36.35	2.28	37.83	2.31	40.45	2.35	42.49	2.40
		80	31.46	2.23	33.50	2.31	35.54	2.40	37.02	2.43	39.63	2.47	41.67	2.52
		85	30.67	2.34	32.71	2.43	34.75	2.51	36.22	2.54	38.82	2.59	40.86	2.64
		90	29.88	2.45	31.92	2.54	33.95	2.63	35.42	2.66	38.01	2.71	40.05	2.77
		95	29.03	2.56	31.05	2.65	33.07	2.75	<b>34.00</b>	<b>2.78</b>	37.12	2.83	39.14	2.89
		100	28.32	2.67	30.34	2.76	32.37	2.87	33.56	2.90	36.41	2.95	38.43	3.01
		105	27.61	2.78	29.64	2.88	31.66	2.98	33.12	3.02	35.70	3.07	37.73	3.13
110		26.91	2.88	28.93	2.99	30.95	3.10	32.41	3.13	35.00	3.19	37.02	3.26	
115		26.20	2.99	28.22	3.10	30.24	3.22	31.71	3.25	34.29	3.31	36.31	3.38	
118	25.78	3.06	27.80	3.17	29.82	3.29	31.28	3.32	33.87	3.39	35.89	3.45		
122	25.63	3.15	27.66	3.26	29.68	3.38	31.14	3.42	33.72	3.48	35.75	3.55		

TC = Total Capacity (kBtu/h).

PI = Power Input (kW).

Nominal capacity as rated: 0 ft. above sea level with 25 ft. of refrigerant piping.  
0 ft. level difference between outdoor and indoor units.

Nominal cooling capacity rating obtained with air entering the indoor unit at 80°F dry bulb (DB) and 67°F wet bulb (WB), and outdoor ambient conditions of 95°F dry bulb (DB) and 75°F wet bulb (WB).

The shaded table columns and rows indicate reference data. When operating at this temperature, these values can be different if the system is not running consistently.



Multi F and Multi F MAX Heat Pump System Engineering Manual

Table 73: LMU369HV Cooling Capacity Table — Mixed Indoor Units (continued).

Connected Indoor Units	Combination Capacity Index	Outdoor Air Temp. (°F DB)	Indoor Air Temp. °F DB / °F WB											
			68 / 57		73 / 61		77 / 64		80 / 67		86 / 72		90 / 75	
			TC	PI	TC	PI	TC	PI	TC	PI	TC	PI	TC	PI
Four (4) Mixed Indoor Units	9 + 12 + 12 + 12	14	33.33	1.74	35.40	1.80	37.47	1.87	38.96	1.89	41.61	1.93	43.68	1.96
		20	33.30	1.76	35.37	1.83	37.44	1.90	38.94	1.92	41.58	1.95	43.65	1.99
		25	33.28	1.79	35.35	1.86	37.41	1.92	38.91	1.94	41.55	1.98	43.61	2.02
		30	33.25	1.81	35.32	1.88	37.38	1.95	38.88	1.97	41.51	2.01	43.58	2.05
		35	33.23	1.84	35.29	1.91	37.36	1.98	38.85	2.00	41.48	2.04	43.55	2.08
		40	33.20	1.86	35.27	1.93	37.33	2.00	38.82	2.03	41.45	2.06	43.51	2.11
		45	33.18	1.89	35.24	1.96	37.30	2.03	38.79	2.05	41.42	2.09	43.48	2.13
		50	33.15	1.91	35.21	1.98	37.27	2.06	38.76	2.08	41.39	2.12	43.45	2.16
		55	33.13	1.94	35.18	2.01	37.24	2.08	38.73	2.11	41.36	2.15	43.41	2.19
		60	33.10	1.96	35.16	2.04	37.21	2.11	38.70	2.14	41.32	2.18	43.38	2.22
		65	33.08	1.99	35.13	2.06	37.18	2.14	38.67	2.16	41.29	2.20	43.35	2.25
		70	33.05	2.01	35.10	2.09	37.16	2.16	38.64	2.19	41.26	2.23	43.31	2.28
		75	32.26	2.12	34.30	2.20	36.35	2.28	37.83	2.31	40.45	2.35	42.49	2.40
		80	31.46	2.23	33.50	2.31	35.54	2.40	37.02	2.43	39.63	2.47	41.67	2.52
		85	30.67	2.34	32.71	2.43	34.75	2.51	36.22	2.54	38.82	2.59	40.86	2.64
		90	29.88	2.45	31.92	2.54	33.95	2.63	35.42	2.66	38.01	2.71	40.05	2.77
		95	29.03	2.56	31.05	2.65	33.07	2.75	<b>34.00</b>	<b>2.78</b>	37.12	2.83	39.14	2.89
		100	28.32	2.67	30.34	2.76	32.37	2.87	33.56	2.90	36.41	2.95	38.43	3.01
		105	27.61	2.78	29.64	2.88	31.66	2.98	33.12	3.02	35.70	3.07	37.73	3.13
		110	26.91	2.88	28.93	2.99	30.95	3.10	32.41	3.13	35.00	3.19	37.02	3.26
		115	26.20	2.99	28.22	3.10	30.24	3.22	31.71	3.25	34.29	3.31	36.31	3.38
		118	25.78	3.06	27.80	3.17	29.82	3.29	31.28	3.32	33.87	3.39	35.89	3.45
	122	25.63	3.15	27.66	3.26	29.68	3.38	31.14	3.42	33.72	3.48	35.75	3.55	
	9 + 9 + 9 + 18	14	33.33	1.74	35.40	1.80	37.47	1.87	38.96	1.89	41.61	1.93	43.68	1.96
		20	33.30	1.76	35.37	1.83	37.44	1.90	38.94	1.92	41.58	1.95	43.65	1.99
		25	33.28	1.79	35.35	1.86	37.41	1.92	38.91	1.94	41.55	1.98	43.61	2.02
		30	33.25	1.81	35.32	1.88	37.38	1.95	38.88	1.97	41.51	2.01	43.58	2.05
		35	33.23	1.84	35.29	1.91	37.36	1.98	38.85	2.00	41.48	2.04	43.55	2.08
		40	33.20	1.86	35.27	1.93	37.33	2.00	38.82	2.03	41.45	2.06	43.51	2.11
		45	33.18	1.89	35.24	1.96	37.30	2.03	38.79	2.05	41.42	2.09	43.48	2.13
		50	33.15	1.91	35.21	1.98	37.27	2.06	38.76	2.08	41.39	2.12	43.45	2.16
		55	33.13	1.94	35.18	2.01	37.24	2.08	38.73	2.11	41.36	2.15	43.41	2.19
		60	33.10	1.96	35.16	2.04	37.21	2.11	38.70	2.14	41.32	2.18	43.38	2.22
		65	33.08	1.99	35.13	2.06	37.18	2.14	38.67	2.16	41.29	2.20	43.35	2.25
		70	33.05	2.01	35.10	2.09	37.16	2.16	38.64	2.19	41.26	2.23	43.31	2.28
		75	32.26	2.12	34.30	2.20	36.35	2.28	37.83	2.31	40.45	2.35	42.49	2.40
		80	31.46	2.23	33.50	2.31	35.54	2.40	37.02	2.43	39.63	2.47	41.67	2.52
		85	30.67	2.34	32.71	2.43	34.75	2.51	36.22	2.54	38.82	2.59	40.86	2.64
		90	29.88	2.45	31.92	2.54	33.95	2.63	35.42	2.66	38.01	2.71	40.05	2.77
		95	29.03	2.56	31.05	2.65	33.07	2.75	<b>34.00</b>	<b>2.78</b>	37.12	2.83	39.14	2.89
		100	28.32	2.67	30.34	2.76	32.37	2.87	33.56	2.90	36.41	2.95	38.43	3.01
		105	27.61	2.78	29.64	2.88	31.66	2.98	33.12	3.02	35.70	3.07	37.73	3.13
110		26.91	2.88	28.93	2.99	30.95	3.10	32.41	3.13	35.00	3.19	37.02	3.26	
115		26.20	2.99	28.22	3.10	30.24	3.22	31.71	3.25	34.29	3.31	36.31	3.38	
118		25.78	3.06	27.80	3.17	29.82	3.29	31.28	3.32	33.87	3.39	35.89	3.45	
122	25.63	3.15	27.66	3.26	29.68	3.38	31.14	3.42	33.72	3.48	35.75	3.55		

TC = Total Capacity (kBtu/h).

PI = Power Input (kW).

Nominal capacity as rated: 0 ft. above sea level with 25 ft. of refrigerant piping.  
0 ft. level difference between outdoor and indoor units.

Nominal cooling capacity rating obtained with air entering the indoor unit at 80°F dry bulb (DB) and 67°F wet bulb (WB), and outdoor ambient conditions of 95°F dry bulb (DB) and 75°F wet bulb (WB).

The shaded table columns and rows indicate reference data. When operating at this temperature, these values can be different if the system is not running consistently.

# PERFORMANCE DATA

## Cooling Capacity Tables

MULTI F  
MULTI F MAX

Table 74: LMU369HV Cooling Capacity Table — Mixed Indoor Units (continued).

Connected Indoor Units	Combination Capacity Index	Outdoor Air Temp. (°F DB)	Indoor Air Temp. °F DB / °F WB											
			68 / 57		73 / 61		77 / 64		80 / 67		86 / 72		90 / 75	
			TC	PI	TC	PI	TC	PI	TC	PI	TC	PI	TC	PI
Four (4) Mixed Indoor Units	9 + 9 + 12 + 18	14	33.33	1.74	35.40	1.80	37.47	1.87	38.96	1.89	41.61	1.93	43.68	1.96
		20	33.30	1.76	35.37	1.83	37.44	1.90	38.94	1.92	41.58	1.95	43.65	1.99
		25	33.28	1.79	35.35	1.86	37.41	1.92	38.91	1.94	41.55	1.98	43.61	2.02
		30	33.25	1.81	35.32	1.88	37.38	1.95	38.88	1.97	41.51	2.01	43.58	2.05
		35	33.23	1.84	35.29	1.91	37.36	1.98	38.85	2.00	41.48	2.04	43.55	2.08
		40	33.20	1.86	35.27	1.93	37.33	2.00	38.82	2.03	41.45	2.06	43.51	2.11
		45	33.18	1.89	35.24	1.96	37.30	2.03	38.79	2.05	41.42	2.09	43.48	2.13
		50	33.15	1.91	35.21	1.98	37.27	2.06	38.76	2.08	41.39	2.12	43.45	2.16
		55	33.13	1.94	35.18	2.01	37.24	2.08	38.73	2.11	41.36	2.15	43.41	2.19
		60	33.10	1.96	35.16	2.04	37.21	2.11	38.70	2.14	41.32	2.18	43.38	2.22
		65	33.08	1.99	35.13	2.06	37.18	2.14	38.67	2.16	41.29	2.20	43.35	2.25
		70	33.05	2.01	35.10	2.09	37.16	2.16	38.64	2.19	41.26	2.23	43.31	2.28
		75	32.26	2.12	34.30	2.20	36.35	2.28	37.83	2.31	40.45	2.35	42.49	2.40
		80	31.46	2.23	33.50	2.31	35.54	2.40	37.02	2.43	39.63	2.47	41.67	2.52
		85	30.67	2.34	32.71	2.43	34.75	2.51	36.22	2.54	38.82	2.59	40.86	2.64
		90	29.88	2.45	31.92	2.54	33.95	2.63	35.42	2.66	38.01	2.71	40.05	2.77
		95	29.03	2.56	31.05	2.65	33.07	2.75	<b>34.00</b>	<b>2.78</b>	37.12	2.83	39.14	2.89
		100	28.32	2.67	30.34	2.76	32.37	2.87	33.56	2.90	36.41	2.95	38.43	3.01
		105	27.61	2.78	29.64	2.88	31.66	2.98	33.12	3.02	35.70	3.07	37.73	3.13
		110	26.91	2.88	28.93	2.99	30.95	3.10	32.41	3.13	35.00	3.19	37.02	3.26
		115	26.20	2.99	28.22	3.10	30.24	3.22	31.71	3.25	34.29	3.31	36.31	3.38
	118	25.78	3.06	27.80	3.17	29.82	3.29	31.28	3.32	33.87	3.39	35.89	3.45	
	122	25.63	3.15	27.66	3.26	29.68	3.38	31.14	3.42	33.72	3.48	35.75	3.55	
	12 + 12 + 12 + 12	14	33.33	1.74	35.40	1.80	37.47	1.87	38.96	1.89	41.61	1.93	43.68	1.96
		20	33.30	1.76	35.37	1.83	37.44	1.90	38.94	1.92	41.58	1.95	43.65	1.99
		25	33.28	1.79	35.35	1.86	37.41	1.92	38.91	1.94	41.55	1.98	43.61	2.02
		30	33.25	1.81	35.32	1.88	37.38	1.95	38.88	1.97	41.51	2.01	43.58	2.05
		35	33.23	1.84	35.29	1.91	37.36	1.98	38.85	2.00	41.48	2.04	43.55	2.08
		40	33.20	1.86	35.27	1.93	37.33	2.00	38.82	2.03	41.45	2.06	43.51	2.11
		45	33.18	1.89	35.24	1.96	37.30	2.03	38.79	2.05	41.42	2.09	43.48	2.13
		50	33.15	1.91	35.21	1.98	37.27	2.06	38.76	2.08	41.39	2.12	43.45	2.16
		55	33.13	1.94	35.18	2.01	37.24	2.08	38.73	2.11	41.36	2.15	43.41	2.19
		60	33.10	1.96	35.16	2.04	37.21	2.11	38.70	2.14	41.32	2.18	43.38	2.22
		65	33.08	1.99	35.13	2.06	37.18	2.14	38.67	2.16	41.29	2.20	43.35	2.25
		70	33.05	2.01	35.10	2.09	37.16	2.16	38.64	2.19	41.26	2.23	43.31	2.28
		75	32.26	2.12	34.30	2.20	36.35	2.28	37.83	2.31	40.45	2.35	42.49	2.40
		80	31.46	2.23	33.50	2.31	35.54	2.40	37.02	2.43	39.63	2.47	41.67	2.52
		85	30.67	2.34	32.71	2.43	34.75	2.51	36.22	2.54	38.82	2.59	40.86	2.64
		90	29.88	2.45	31.92	2.54	33.95	2.63	35.42	2.66	38.01	2.71	40.05	2.77
		95	29.03	2.56	31.05	2.65	33.07	2.75	<b>34.00</b>	<b>2.78</b>	37.12	2.83	39.14	2.89
		100	28.32	2.67	30.34	2.76	32.37	2.87	33.56	2.90	36.41	2.95	38.43	3.01
		105	27.61	2.78	29.64	2.88	31.66	2.98	33.12	3.02	35.70	3.07	37.73	3.13
110		26.91	2.88	28.93	2.99	30.95	3.10	32.41	3.13	35.00	3.19	37.02	3.26	
115		26.20	2.99	28.22	3.10	30.24	3.22	31.71	3.25	34.29	3.31	36.31	3.38	
118	25.78	3.06	27.80	3.17	29.82	3.29	31.28	3.32	33.87	3.39	35.89	3.45		
122	25.63	3.15	27.66	3.26	29.68	3.38	31.14	3.42	33.72	3.48	35.75	3.55		

TC = Total Capacity (kBtu/h).

PI = Power Input (kW).

Nominal capacity as rated: 0 ft. above sea level with 25 ft. of refrigerant piping.  
0 ft. level difference between outdoor and indoor units.

Nominal cooling capacity rating obtained with air entering the indoor unit at 80°F dry bulb (DB) and 67°F wet bulb (WB), and outdoor ambient conditions of 95°F dry bulb (DB) and 75°F wet bulb (WB).

The shaded table columns and rows indicate reference data. When operating at this temperature, these values can be different if the system is not running consistently.



Multi F and Multi F MAX Heat Pump System Engineering Manual

Table 75: LMU187HV Heating Capacity Table — Non-Ducted Indoor Units.

Connected Indoor Units	Combination Capacity Index	Outdoor Air Temp.		Indoor Air Temp. °F DB												
		°F DB	°F WB	61		64		68		70		72		75		
				TC	PI	TC	PI	TC	PI	TC	PI	TC	PI	TC	PI	
Two (2) Non-Ducted Indoor Units	9 + 9	0	-0.4	6.32	0.94	5.92	0.98	5.96	1.00	5.82	1.00	5.70	1.01	5.46	1.05	
		5	4.5	8.22	0.96	7.82	1.00	7.72	1.02	7.55	1.03	7.42	1.04	7.12	1.07	
		10	9	9.49	0.98	9.10	1.01	8.90	1.04	8.72	1.05	8.57	1.06	8.24	1.10	
		17	15	10.88	1.00	10.50	1.03	10.20	1.06	10.00	1.08	9.84	1.09	9.46	1.13	
		20	19	11.73	1.01	11.35	1.04	10.99	1.08	10.78	1.10	10.61	1.12	10.20	1.15	
		25	23	13.14	1.04	12.75	1.07	12.30	1.11	12.07	1.13	11.88	1.15	11.44	1.18	
		30	28	14.55	1.07	14.10	1.11	13.61	1.14	13.36	1.16	13.16	1.18	12.68	1.21	
		35	32	15.96	1.10	15.45	1.14	14.93	1.17	14.66	1.20	14.44	1.22	13.92	1.25	
		40	36	16.77	1.13	16.30	1.17	15.78	1.21	15.51	1.23	15.29	1.25	14.74	1.28	
		45	41	17.79	1.17	17.37	1.21	16.85	1.25	16.57	1.27	16.35	1.29	15.76	1.33	
		47	43	18.20	1.19	17.79	1.23	17.28	1.27	17.00	1.29	16.77	1.31	16.16	1.35	
		50	46	18.25	1.18	17.88	1.22	17.44	1.25	17.19	1.27	16.99	1.29	16.41	1.32	
		55	51	18.34	1.17	18.04	1.20	17.70	1.23	17.50	1.24	17.34	1.25	16.82	1.28	
		60	56	18.43	1.16	18.19	1.18	17.97	1.20	17.81	1.21	17.69	1.22	17.24	1.24	
		63	59	18.48	1.15	18.28	1.17	18.12	1.19	18.00	1.19	17.90	1.20	17.48	1.21	
		68	64	18.54	1.14	18.37	1.16	18.28	1.17	18.19	1.17	18.11	1.18	17.73	1.19	
		9 + 12	0	-0.4	6.32	0.94	5.92	0.98	5.96	1.00	5.82	1.00	5.70	1.01	5.46	1.05
			5	4.5	8.22	0.96	7.82	1.00	7.72	1.02	7.55	1.03	7.42	1.04	7.12	1.07
	10		9	9.49	0.98	9.10	1.01	8.90	1.04	8.72	1.05	8.57	1.06	8.24	1.10	
	17		15	10.88	1.00	10.50	1.03	10.20	1.06	10.00	1.08	9.84	1.09	9.46	1.13	
	20		19	11.73	1.01	11.35	1.04	10.99	1.08	10.78	1.10	10.61	1.12	10.20	1.15	
	25		23	13.14	1.04	12.75	1.07	12.30	1.11	12.07	1.13	11.88	1.15	11.44	1.18	
	30		28	14.55	1.07	14.10	1.11	13.61	1.14	13.36	1.16	13.16	1.18	12.68	1.21	
	35		32	15.96	1.10	15.45	1.14	14.93	1.17	14.66	1.20	14.44	1.22	13.92	1.25	
	40		36	16.77	1.13	16.30	1.17	15.78	1.21	15.51	1.23	15.29	1.25	14.74	1.28	
	45		41	17.79	1.17	17.37	1.21	16.85	1.25	16.57	1.27	16.35	1.29	15.76	1.33	
	47		43	18.20	1.19	17.79	1.23	17.28	1.27	17.00	1.29	16.77	1.31	16.16	1.35	
	50		46	18.25	1.18	17.88	1.22	17.44	1.25	17.19	1.27	16.99	1.29	16.41	1.32	
	55		51	18.34	1.17	18.04	1.20	17.70	1.23	17.50	1.24	17.34	1.25	16.82	1.28	
	60		56	18.43	1.16	18.19	1.18	17.97	1.20	17.81	1.21	17.69	1.22	17.24	1.24	
	63		59	18.48	1.15	18.28	1.17	18.12	1.19	18.00	1.19	17.90	1.20	17.48	1.21	
	68		64	18.54	1.14	18.37	1.16	18.28	1.17	18.19	1.17	18.11	1.18	17.73	1.19	
	12 + 12		0	-0.4	6.32	0.94	5.92	0.98	5.96	1.00	5.82	1.00	5.70	1.01	5.46	1.05
			5	4.5	8.22	0.96	7.82	1.00	7.72	1.02	7.55	1.03	7.42	1.04	7.12	1.07
		10	9	9.49	0.98	9.10	1.01	8.90	1.04	8.72	1.05	8.57	1.06	8.24	1.10	
		17	15	10.88	1.00	10.50	1.03	10.20	1.06	10.00	1.08	9.84	1.09	9.46	1.13	
		20	19	11.73	1.01	11.35	1.04	10.99	1.08	10.78	1.10	10.61	1.12	10.20	1.15	
		25	23	13.14	1.04	12.75	1.07	12.30	1.11	12.07	1.13	11.88	1.15	11.44	1.18	
		30	28	14.55	1.07	14.10	1.11	13.61	1.14	13.36	1.16	13.16	1.18	12.68	1.21	
		35	32	15.96	1.10	15.45	1.14	14.93	1.17	14.66	1.20	14.44	1.22	13.92	1.25	
		40	36	16.77	1.13	16.30	1.17	15.78	1.21	15.51	1.23	15.29	1.25	14.74	1.28	
		45	41	17.79	1.17	17.37	1.21	16.85	1.25	16.57	1.27	16.35	1.29	15.76	1.33	
		47	43	18.20	1.19	17.79	1.23	17.28	1.27	17.00	1.29	16.77	1.31	16.16	1.35	
		50	46	18.25	1.18	17.88	1.22	17.44	1.25	17.19	1.27	16.99	1.29	16.41	1.32	
		55	51	18.34	1.17	18.04	1.20	17.70	1.23	17.50	1.24	17.34	1.25	16.82	1.28	
		60	56	18.43	1.16	18.19	1.18	17.97	1.20	17.81	1.21	17.69	1.22	17.24	1.24	
		63	59	18.48	1.15	18.28	1.17	18.12	1.19	18.00	1.19	17.90	1.20	17.48	1.21	
		68	64	18.54	1.14	18.37	1.16	18.28	1.17	18.19	1.17	18.11	1.18	17.73	1.19	

TC = Total Capacity (kBtu/h).

PI = Power Input (kW).

Nominal capacity as rated: 0 ft. above sea level with 25 ft. of refrigerant piping.  
0 ft. level difference between outdoor and indoor units.

Nominal heating capacity rating obtained with air entering the indoor unit at 70°F dry bulb (DB) and 60°F wet bulb (WB), and outdoor ambient conditions of 47°F dry bulb (DB) and 43°F wet bulb (WB).

# PERFORMANCE DATA

## Heating Capacity Tables

MULTI F  
MULTI F MAX

Table 76: LMU187HV Heating Capacity Table — Ducted Indoor Units.

Connected Indoor Units	Combination Capacity Index	Outdoor Air Temp.		Indoor Air Temp. °F DB												
		°F DB	°F WB	61		64		68		70		72		75		
				TC	PI	TC	PI	TC	PI	TC	PI	TC	PI	TC	PI	
Two (2) Ducted Indoor Units	9 + 9	0	-0.4	6.28	0.97	5.88	1.01	5.92	1.02	5.78	1.03	5.67	1.04	5.43	1.08	
		5	4.5	8.15	0.99	7.76	1.02	7.66	1.04	7.49	1.05	7.36	1.06	7.06	1.10	
		10	9	9.40	1.00	9.02	1.03	8.82	1.06	8.64	1.08	8.50	1.09	8.16	1.12	
		17	15	10.77	1.02	10.40	1.05	10.10	1.09	<b>9.90</b>	<b>1.10</b>	9.74	1.12	9.37	1.15	
		20	19	11.60	1.03	11.23	1.06	10.87	1.10	10.66	1.12	10.50	1.14	10.10	1.17	
		25	23	12.99	1.06	12.61	1.09	12.17	1.13	11.94	1.15	11.75	1.17	11.31	1.20	
		30	28	14.38	1.09	13.94	1.12	13.46	1.16	13.21	1.18	13.01	1.20	12.54	1.24	
		35	32	15.77	1.12	15.27	1.16	14.75	1.19	14.49	1.22	14.27	1.24	13.76	1.27	
		40	36	16.58	1.15	16.11	1.19	15.60	1.22	15.33	1.25	15.11	1.27	14.56	1.30	
		45	41	17.58	1.19	17.16	1.23	16.66	1.27	16.38	1.29	16.16	1.31	15.57	1.35	
		47	43	17.98	1.21	17.58	1.25	17.08	1.29	<b>16.80</b>	<b>1.31</b>	16.58	1.33	15.97	1.37	
		50	46	18.04	1.20	17.67	1.24	17.23	1.27	16.99	1.29	16.79	1.31	16.22	1.34	
		55	51	18.12	1.19	17.82	1.22	17.49	1.25	17.29	1.26	17.13	1.27	16.63	1.30	
		60	56	18.21	1.17	17.98	1.20	17.75	1.22	17.60	1.23	17.48	1.24	17.03	1.26	
		63	59	18.27	1.17	18.07	1.19	17.91	1.20	17.79	1.21	17.69	1.21	17.28	1.23	
		68	64	18.32	1.16	18.16	1.17	18.07	1.19	17.97	1.19	17.90	1.19	17.53	1.20	
		9 + 12	0	-0.4	6.28	0.97	5.88	1.01	5.92	1.02	5.78	1.03	5.67	1.04	5.43	1.08
			5	4.5	8.15	0.99	7.76	1.02	7.66	1.04	7.49	1.05	7.36	1.06	7.06	1.10
	10		9	9.40	1.00	9.02	1.03	8.82	1.06	8.64	1.08	8.50	1.09	8.16	1.12	
	17		15	10.77	1.02	10.40	1.05	10.10	1.09	<b>9.90</b>	<b>1.10</b>	9.74	1.12	9.37	1.15	
	20		19	11.60	1.03	11.23	1.06	10.87	1.10	10.66	1.12	10.50	1.14	10.10	1.17	
	25		23	12.99	1.06	12.61	1.09	12.17	1.13	11.94	1.15	11.75	1.17	11.31	1.20	
	30		28	14.38	1.09	13.94	1.12	13.46	1.16	13.21	1.18	13.01	1.20	12.54	1.24	
	35		32	15.77	1.12	15.27	1.16	14.75	1.19	14.49	1.22	14.27	1.24	13.76	1.27	
	40		36	16.58	1.15	16.11	1.19	15.60	1.22	15.33	1.25	15.11	1.27	14.56	1.30	
	45		41	17.58	1.19	17.16	1.23	16.66	1.27	16.38	1.29	16.16	1.31	15.57	1.35	
	47		43	17.98	1.21	17.58	1.25	17.08	1.29	<b>16.80</b>	<b>1.31</b>	16.58	1.33	15.97	1.37	
	50		46	18.04	1.20	17.67	1.24	17.23	1.27	16.99	1.29	16.79	1.31	16.22	1.34	
	55		51	18.12	1.19	17.82	1.22	17.49	1.25	17.29	1.26	17.13	1.27	16.63	1.30	
	60		56	18.21	1.17	17.98	1.20	17.75	1.22	17.60	1.23	17.48	1.24	17.03	1.26	
	63		59	18.27	1.17	18.07	1.19	17.91	1.20	17.79	1.21	17.69	1.21	17.28	1.23	
	68		64	18.32	1.16	18.16	1.17	18.07	1.19	17.97	1.19	17.90	1.19	17.53	1.20	
	12 + 12		0	-0.4	6.28	0.97	5.88	1.01	5.92	1.02	5.78	1.03	5.67	1.04	5.43	1.08
			5	4.5	8.15	0.99	7.76	1.02	7.66	1.04	7.49	1.05	7.36	1.06	7.06	1.10
		10	9	9.40	1.00	9.02	1.03	8.82	1.06	8.64	1.08	8.50	1.09	8.16	1.12	
		17	15	10.77	1.02	10.40	1.05	10.10	1.09	<b>9.90</b>	<b>1.10</b>	9.74	1.12	9.37	1.15	
		20	19	11.60	1.03	11.23	1.06	10.87	1.10	10.66	1.12	10.50	1.14	10.10	1.17	
		25	23	12.99	1.06	12.61	1.09	12.17	1.13	11.94	1.15	11.75	1.17	11.31	1.20	
		30	28	14.38	1.09	13.94	1.12	13.46	1.16	13.21	1.18	13.01	1.20	12.54	1.24	
		35	32	15.77	1.12	15.27	1.16	14.75	1.19	14.49	1.22	14.27	1.24	13.76	1.27	
		40	36	16.58	1.15	16.11	1.19	15.60	1.22	15.33	1.25	15.11	1.27	14.56	1.30	
		45	41	17.58	1.19	17.16	1.23	16.66	1.27	16.38	1.29	16.16	1.31	15.57	1.35	
		47	43	17.98	1.21	17.58	1.25	17.08	1.29	<b>16.80</b>	<b>1.31</b>	16.58	1.33	15.97	1.37	
		50	46	18.04	1.20	17.67	1.24	17.23	1.27	16.99	1.29	16.79	1.31	16.22	1.34	
		55	51	18.12	1.19	17.82	1.22	17.49	1.25	17.29	1.26	17.13	1.27	16.63	1.30	
		60	56	18.21	1.17	17.98	1.20	17.75	1.22	17.60	1.23	17.48	1.24	17.03	1.26	
		63	59	18.27	1.17	18.07	1.19	17.91	1.20	17.79	1.21	17.69	1.21	17.28	1.23	
		68	64	18.32	1.16	18.16	1.17	18.07	1.19	17.97	1.19	17.90	1.19	17.53	1.20	

TC = Total Capacity (kBtu/h).

PI = Power Input (kW).

Nominal capacity as rated: 0 ft. above sea level with 25 ft. of refrigerant piping.

0 ft. level difference between outdoor and indoor units.

Nominal heating capacity rating obtained with air entering the indoor unit at 70°F dry bulb (DB) and 60°F wet bulb (WB), and outdoor ambient conditions of 47°F dry bulb (DB) and 43°F wet bulb (WB).

Multi F and Multi F MAX Heat Pump System Engineering Manual

Table 77: LMU187HV Heating Capacity Table — Mixed Indoor Units.

Connected Indoor Units	Combination Capacity Index	Outdoor Air Temp.		Indoor Air Temp. °F DB											
		°F DB	°F WB	61		64		68		70		72		75	
				TC	PI	TC	PI	TC	PI	TC	PI	TC	PI	TC	PI
Two (2) Mixed Indoor Units	9 + 9	0	-0.4	6.30	0.96	5.90	0.99	5.94	1.01	5.80	1.02	5.69	1.03	5.44	1.06
		5	4.5	8.18	0.97	7.79	1.01	7.69	1.03	7.52	1.04	7.39	1.05	7.09	1.09
		10	9	9.44	0.99	9.06	1.02	8.86	1.05	8.68	1.06	8.53	1.07	8.20	1.11
		17	15	10.83	1.01	10.45	1.04	10.15	1.07	<b>9.95</b>	<b>1.09</b>	9.79	1.11	9.41	1.14
		20	19	11.67	1.02	11.29	1.05	10.93	1.09	10.72	1.11	10.55	1.13	10.15	1.16
		25	23	13.06	1.05	12.68	1.08	12.24	1.12	12.00	1.14	11.82	1.16	11.37	1.19
		30	28	14.47	1.08	14.02	1.11	13.54	1.15	13.29	1.17	13.09	1.19	12.61	1.22
		35	32	15.87	1.11	15.36	1.15	14.84	1.18	14.57	1.21	14.36	1.23	13.84	1.26
		40	36	16.68	1.14	16.21	1.18	15.69	1.21	15.42	1.24	15.20	1.26	14.65	1.29
		45	41	17.69	1.18	17.26	1.22	16.75	1.26	16.48	1.28	16.25	1.30	15.66	1.34
		47	43	18.09	1.20	17.69	1.24	17.18	1.28	<b>16.90</b>	<b>1.30</b>	16.68	1.32	16.07	1.36
		50	46	18.14	1.19	17.78	1.23	17.34	1.26	17.09	1.28	16.89	1.30	16.32	1.33
	55	51	18.23	1.18	17.93	1.21	17.60	1.24	17.40	1.25	17.23	1.26	16.72	1.29	
	60	56	18.32	1.17	18.08	1.19	17.86	1.21	17.71	1.22	17.58	1.23	17.13	1.25	
	63	59	18.37	1.16	18.17	1.18	18.02	1.19	17.89	1.20	17.79	1.21	17.38	1.22	
	68	64	18.43	1.15	18.27	1.17	18.17	1.18	18.08	1.18	18.01	1.19	17.63	1.19	
	9 + 12	0	-0.4	6.30	0.96	5.90	0.99	5.94	1.01	5.80	1.02	5.69	1.03	5.44	1.06
		5	4.5	8.18	0.97	7.79	1.01	7.69	1.03	7.52	1.04	7.39	1.05	7.09	1.09
		10	9	9.44	0.99	9.06	1.02	8.86	1.05	8.68	1.06	8.53	1.07	8.20	1.11
		17	15	10.83	1.01	10.45	1.04	10.15	1.07	<b>9.95</b>	<b>1.09</b>	9.79	1.11	9.41	1.14
		20	19	11.67	1.02	11.29	1.05	10.93	1.09	10.72	1.11	10.55	1.13	10.15	1.16
		25	23	13.06	1.05	12.68	1.08	12.24	1.12	12.00	1.14	11.82	1.16	11.37	1.19
		30	28	14.47	1.08	14.02	1.11	13.54	1.15	13.29	1.17	13.09	1.19	12.61	1.22
		35	32	15.87	1.11	15.36	1.15	14.84	1.18	14.57	1.21	14.36	1.23	13.84	1.26
		40	36	16.68	1.14	16.21	1.18	15.69	1.21	15.42	1.24	15.20	1.26	14.65	1.29
		45	41	17.69	1.18	17.26	1.22	16.75	1.26	16.48	1.28	16.25	1.30	15.66	1.34
		47	43	18.09	1.20	17.69	1.24	17.18	1.28	<b>16.90</b>	<b>1.30</b>	16.68	1.32	16.07	1.36
		50	46	18.14	1.19	17.78	1.23	17.34	1.26	17.09	1.28	16.89	1.30	16.32	1.33
	55	51	18.23	1.18	17.93	1.21	17.60	1.24	17.40	1.25	17.23	1.26	16.72	1.29	
	60	56	18.32	1.17	18.08	1.19	17.86	1.21	17.71	1.22	17.58	1.23	17.13	1.25	
	63	59	18.37	1.16	18.17	1.18	18.02	1.19	17.89	1.20	17.79	1.21	17.38	1.22	
	68	64	18.43	1.15	18.27	1.17	18.17	1.18	18.08	1.18	18.01	1.19	17.63	1.19	
	12 + 12	0	-0.4	6.30	0.96	5.90	0.99	5.94	1.01	5.80	1.02	5.69	1.03	5.44	1.06
		5	4.5	8.18	0.97	7.79	1.01	7.69	1.03	7.52	1.04	7.39	1.05	7.09	1.09
		10	9	9.44	0.99	9.06	1.02	8.86	1.05	8.68	1.06	8.53	1.07	8.20	1.11
		17	15	10.83	1.01	10.45	1.04	10.15	1.07	<b>9.95</b>	<b>1.09</b>	9.79	1.11	9.41	1.14
		20	19	11.67	1.02	11.29	1.05	10.93	1.09	10.72	1.11	10.55	1.13	10.15	1.16
		25	23	13.06	1.05	12.68	1.08	12.24	1.12	12.00	1.14	11.82	1.16	11.37	1.19
		30	28	14.47	1.08	14.02	1.11	13.54	1.15	13.29	1.17	13.09	1.19	12.61	1.22
		35	32	15.87	1.11	15.36	1.15	14.84	1.18	14.57	1.21	14.36	1.23	13.84	1.26
		40	36	16.68	1.14	16.21	1.18	15.69	1.21	15.42	1.24	15.20	1.26	14.65	1.29
		45	41	17.69	1.18	17.26	1.22	16.75	1.26	16.48	1.28	16.25	1.30	15.66	1.34
		47	43	18.09	1.20	17.69	1.24	17.18	1.28	<b>16.90</b>	<b>1.30</b>	16.68	1.32	16.07	1.36
		50	46	18.14	1.19	17.78	1.23	17.34	1.26	17.09	1.28	16.89	1.30	16.32	1.33
	55	51	18.23	1.18	17.93	1.21	17.60	1.24	17.40	1.25	17.23	1.26	16.72	1.29	
	60	56	18.32	1.17	18.08	1.19	17.86	1.21	17.71	1.22	17.58	1.23	17.13	1.25	
	63	59	18.37	1.16	18.17	1.18	18.02	1.19	17.89	1.20	17.79	1.21	17.38	1.22	
	68	64	18.43	1.15	18.27	1.17	18.17	1.18	18.08	1.18	18.01	1.19	17.63	1.19	

TC = Total Capacity (kBtu/h).

PI = Power Input (kW).

Nominal capacity as rated: 0 ft. above sea level with 25 ft. of refrigerant piping.  
0 ft. level difference between outdoor and indoor units.

Nominal heating capacity rating obtained with air entering the indoor unit at 70°F dry bulb (DB) and 60°F wet bulb (WB), and outdoor ambient conditions of 47°F dry bulb (DB) and 43°F wet bulb (WB).

# PERFORMANCE DATA

## Heating Capacity Tables

MULTI F  
MULTI F MAX

Table 78: LMU247HV Heating Capacity Table — Non-Ducted Indoor Units.

Connected Indoor Units	Combination Capacity Index	Outdoor Air Temp.		Indoor Air Temp. °F DB											
		°F DB	°F WB	61		64		68		70		72		75	
				TC	PI	TC	PI	TC	PI	TC	PI	TC	PI	TC	PI
Two (2) Non-Ducted Indoor Units	9 + 9	0	-0.4	8.59	1.44	8.06	1.50	8.09	1.52	7.90	1.54	7.75	1.55	7.42	1.60
		5	4.5	10.64	1.47	10.13	1.52	9.99	1.55	9.78	1.57	9.61	1.58	9.22	1.64
		10	9	12.01	1.49	11.52	1.54	11.27	1.58	11.04	1.60	10.85	1.62	10.43	1.67
		17	15	13.51	1.52	13.04	1.57	12.67	1.62	<b>12.42</b>	<b>1.64</b>	12.22	1.66	11.75	1.71
		20	19	14.43	1.54	13.97	1.59	13.52	1.64	13.26	1.67	13.05	1.70	12.55	1.74
		25	23	15.95	1.58	15.48	1.62	14.94	1.68	14.66	1.72	14.43	1.74	13.89	1.79
		30	28	17.48	1.62	16.94	1.67	16.35	1.73	16.05	1.76	15.81	1.79	15.23	1.84
		35	32	19.00	1.66	18.40	1.72	17.77	1.77	17.45	1.81	17.20	1.84	16.57	1.89
		40	36	19.97	1.71	19.41	1.77	18.79	1.82	18.47	1.86	18.21	1.89	17.55	1.94
		45	41	21.18	1.77	20.68	1.83	20.07	1.89	19.73	1.92	19.47	1.95	18.76	2.01
		47	43	21.67	1.80	21.18	1.86	20.58	1.92	<b>20.24</b>	<b>1.95</b>	19.97	1.98	19.24	2.04
		50	46	21.73	1.79	21.29	1.84	20.76	1.89	20.46	1.92	20.22	1.94	19.54	2.00
	55	51	21.84	1.77	21.47	1.81	21.08	1.85	20.83	1.88	20.64	1.89	20.03	1.93	
	60	56	21.94	1.75	21.66	1.78	21.39	1.82	21.21	1.83	21.06	1.84	20.52	1.87	
	63	59	22.00	1.74	21.77	1.77	21.58	1.79	21.43	1.80	21.31	1.81	20.82	1.83	
	68	64	22.07	1.73	21.88	1.75	21.77	1.77	21.65	1.77	21.57	1.78	21.11	1.79	
	9 + 12	0	-0.4	9.76	1.61	9.16	1.67	9.19	1.70	8.98	1.71	8.81	1.72	8.43	1.78
		5	4.5	12.09	1.63	11.51	1.69	11.35	1.73	11.11	1.75	10.92	1.76	10.48	1.82
		10	9	13.64	1.66	13.09	1.71	12.80	1.76	12.54	1.78	12.33	1.80	11.85	1.86
		17	15	15.36	1.69	14.82	1.74	14.40	1.80	<b>14.11</b>	<b>1.83</b>	13.89	1.85	13.35	1.91
		20	19	16.40	1.71	15.87	1.76	15.36	1.83	15.07	1.86	14.83	1.89	14.27	1.94
		25	23	18.12	1.75	17.59	1.81	16.98	1.87	16.65	1.91	16.40	1.94	15.78	1.99
		30	28	19.86	1.80	19.25	1.86	18.58	1.92	18.24	1.96	17.97	2.00	17.31	2.05
		35	32	21.59	1.85	20.91	1.92	20.19	1.97	19.83	2.01	19.54	2.05	18.83	2.10
		40	36	22.69	1.91	22.06	1.97	21.35	2.03	20.98	2.07	20.69	2.10	19.94	2.16
		45	41	24.07	1.97	23.49	2.04	22.80	2.10	22.42	2.14	22.12	2.17	21.32	2.24
		47	43	24.62	2.00	24.07	2.07	23.38	2.13	<b>23.00</b>	<b>2.17</b>	22.69	2.20	21.87	2.27
		50	46	24.69	1.99	24.19	2.05	23.60	2.11	23.25	2.14	22.98	2.16	22.20	2.22
	55	51	24.81	1.97	24.40	2.02	23.95	2.06	23.68	2.09	23.46	2.11	22.76	2.15	
	60	56	24.93	1.95	24.61	1.98	24.31	2.02	24.10	2.04	23.93	2.05	23.32	2.08	
	63	59	25.01	1.93	24.73	1.96	24.52	1.99	24.35	2.00	24.22	2.01	23.65	2.04	
	68	64	25.08	1.92	24.86	1.95	24.73	1.97	24.61	1.97	24.51	1.98	23.99	1.99	
	12 + 12	0	-0.4	11.20	1.72	10.52	1.78	10.55	1.81	10.30	1.83	10.11	1.84	9.68	1.91
		5	4.5	13.87	1.75	13.22	1.81	13.03	1.85	12.75	1.87	12.53	1.89	12.03	1.95
		10	9	15.66	1.77	15.02	1.83	14.69	1.88	14.40	1.91	14.16	1.93	13.60	1.99
		17	15	17.63	1.81	17.01	1.87	16.52	1.92	<b>16.20</b>	<b>1.96</b>	15.94	1.98	15.33	2.04
		20	19	18.82	1.83	18.22	1.89	17.63	1.95	17.29	1.99	17.02	2.02	16.38	2.07
		25	23	20.80	1.88	20.19	1.93	19.49	2.00	19.12	2.04	18.82	2.08	18.11	2.13
		30	28	22.80	1.93	22.09	1.99	21.33	2.05	20.94	2.10	20.63	2.13	19.87	2.19
		35	32	24.79	1.98	24.00	2.05	23.18	2.10	22.76	2.15	22.43	2.19	21.62	2.25
		40	36	26.05	2.04	25.32	2.11	24.51	2.17	24.09	2.21	23.75	2.25	22.89	2.31
		45	41	27.63	2.11	26.97	2.18	26.17	2.25	25.74	2.29	25.39	2.32	24.47	2.39
		47	43	28.26	2.14	27.63	2.21	26.84	2.28	<b>26.40</b>	<b>2.32</b>	26.05	2.35	25.10	2.42
		50	46	28.34	2.13	27.77	2.19	27.08	2.25	26.69	2.29	26.38	2.31	25.49	2.38
	55	51	28.48	2.10	28.01	2.16	27.49	2.21	27.18	2.23	26.92	2.25	26.13	2.30	
	60	56	28.62	2.08	28.25	2.12	27.90	2.16	27.66	2.18	27.47	2.19	26.77	2.22	
	63	59	28.70	2.07	28.39	2.10	28.14	2.13	27.95	2.14	27.80	2.15	27.15	2.18	
	68	64	28.79	2.05	28.53	2.08	28.39	2.10	28.25	2.11	28.13	2.11	27.54	2.13	

TC = Total Capacity (kBtu/h).

PI = Power Input (kW).

Nominal capacity as rated: 0 ft. above sea level with 25 ft. of refrigerant piping.  
0 ft. level difference between outdoor and indoor units.

Nominal heating capacity rating obtained with air entering the indoor unit at 70°F dry bulb (DB) and 60°F wet bulb (WB), and outdoor ambient conditions of 47°F dry bulb (DB) and 43°F wet bulb (WB).



Multi F and Multi F MAX Heat Pump System Engineering Manual

Table 79: LMU247HV Heating Capacity Table — Non-Ducted Units (continued).

Connected Indoor Units	Combination Capacity Index	Outdoor Air Temp.		Indoor Air Temp. °F DB													
		°F DB	°F WB	61		64		68		70		72		75			
				TC	PI	TC	PI	TC	PI	TC	PI	TC	PI	TC	PI		
Two (2) Non-Ducted Indoor Units	9 + 18	0	-0.4	11.20	1.72	10.52	1.78	10.55	1.81	10.30	1.83	10.11	1.84	9.68	1.91		
		5	4.5	13.87	1.75	13.22	1.81	13.03	1.85	12.75	1.87	12.53	1.89	12.03	1.95		
		10	9	15.66	1.77	15.02	1.83	14.69	1.88	14.40	1.91	14.16	1.93	13.60	1.99		
		17	15	17.63	1.81	17.01	1.87	16.52	1.92	<b>16.20</b>	<b>1.96</b>	15.94	1.98	15.33	2.04		
		20	19	18.82	1.83	18.22	1.89	17.63	1.95	17.29	1.99	17.02	2.02	16.38	2.07		
		25	23	20.80	1.88	20.19	1.93	19.49	2.00	19.12	2.04	18.82	2.08	18.11	2.13		
		30	28	22.80	1.93	22.09	1.99	21.33	2.05	20.94	2.10	20.63	2.13	19.87	2.19		
		35	32	24.79	1.98	24.00	2.05	23.18	2.10	22.76	2.15	22.43	2.19	21.62	2.25		
		40	36	26.05	2.04	25.32	2.11	24.51	2.17	24.09	2.21	23.75	2.25	22.89	2.31		
		45	41	27.63	2.11	26.97	2.18	26.17	2.25	25.74	2.29	25.39	2.32	24.47	2.39		
		47	43	28.26	2.14	27.63	2.21	26.84	2.28	<b>26.40</b>	<b>2.32</b>	26.05	2.35	25.10	2.42		
		50	46	28.34	2.13	27.77	2.19	27.08	2.25	26.69	2.29	26.38	2.31	25.49	2.38		
		55	51	28.48	2.10	28.01	2.16	27.49	2.21	27.18	2.23	26.92	2.25	26.13	2.30		
		60	56	28.62	2.08	28.25	2.12	27.90	2.16	27.66	2.18	27.47	2.19	26.77	2.22		
		63	59	28.70	2.07	28.39	2.10	28.14	2.13	27.95	2.14	27.80	2.15	27.15	2.18		
		68	64	28.79	2.05	28.53	2.08	28.39	2.10	28.25	2.11	28.13	2.11	27.54	2.13		
		12 + 18	0	-0.4	11.20	1.72	10.52	1.78	10.55	1.81	10.30	1.83	10.11	1.84	9.68	1.91	
			5	4.5	13.87	1.75	13.22	1.81	13.03	1.85	12.75	1.87	12.53	1.89	12.03	1.95	
	10		9	15.66	1.77	15.02	1.83	14.69	1.88	14.40	1.91	14.16	1.93	13.60	1.99		
	17		15	17.63	1.81	17.01	1.87	16.52	1.92	<b>16.20</b>	<b>1.96</b>	15.94	1.98	15.33	2.04		
	20		19	18.82	1.83	18.22	1.89	17.63	1.95	17.29	1.99	17.02	2.02	16.38	2.07		
	25		23	20.80	1.88	20.19	1.93	19.49	2.00	19.12	2.04	18.82	2.08	18.11	2.13		
	30		28	22.80	1.93	22.09	1.99	21.33	2.05	20.94	2.10	20.63	2.13	19.87	2.19		
	35		32	24.79	1.98	24.00	2.05	23.18	2.10	22.76	2.15	22.43	2.19	21.62	2.25		
	40		36	26.05	2.04	25.32	2.11	24.51	2.17	24.09	2.21	23.75	2.25	22.89	2.31		
	45		41	27.63	2.11	26.97	2.18	26.17	2.25	25.74	2.29	25.39	2.32	24.47	2.39		
	47		43	28.26	2.14	27.63	2.21	26.84	2.28	<b>26.40</b>	<b>2.32</b>	26.05	2.35	25.10	2.42		
	50		46	28.34	2.13	27.77	2.19	27.08	2.25	26.69	2.29	26.38	2.31	25.49	2.38		
	55		51	28.48	2.10	28.01	2.16	27.49	2.21	27.18	2.23	26.92	2.25	26.13	2.30		
	60		56	28.62	2.08	28.25	2.12	27.90	2.16	27.66	2.18	27.47	2.19	26.77	2.22		
	63		59	28.70	2.07	28.39	2.10	28.14	2.13	27.95	2.14	27.80	2.15	27.15	2.18		
	68		64	28.79	2.05	28.53	2.08	28.39	2.10	28.25	2.11	28.13	2.11	27.54	2.13		
	Three (3) Non-Ducted Indoor Units		9 + 9 + 9	0	-0.4	11.20	1.64	10.52	1.70	10.55	1.73	10.30	1.74	10.11	1.75	9.68	1.82
				5	4.5	13.87	1.66	13.22	1.72	13.03	1.76	12.75	1.78	12.53	1.80	12.03	1.86
		10		9	15.66	1.69	15.02	1.75	14.69	1.79	14.40	1.82	14.16	1.84	13.60	1.89	
		17		15	17.63	1.72	17.01	1.78	16.52	1.83	<b>16.20</b>	<b>1.86</b>	15.94	1.89	15.33	1.94	
20		19		18.82	1.74	18.22	1.80	17.63	1.86	17.29	1.89	17.02	1.92	16.38	1.97		
25		23		20.80	1.79	20.19	1.84	19.49	1.91	19.12	1.95	18.82	1.98	18.11	2.03		
30		28		22.80	1.84	22.09	1.90	21.33	1.96	20.94	2.00	20.63	2.03	19.87	2.08		
35		32		24.79	1.89	24.00	1.95	23.18	2.00	22.76	2.05	22.43	2.09	21.62	2.14		
40		36		26.05	1.94	25.32	2.01	24.51	2.07	24.09	2.11	23.75	2.14	22.89	2.20		
45		41		27.63	2.01	26.97	2.08	26.17	2.14	25.74	2.18	25.39	2.21	24.47	2.28		
47		43		28.26	2.04	27.63	2.11	26.84	2.17	<b>26.40</b>	<b>2.21</b>	26.05	2.24	25.10	2.31		
50		46		28.34	2.03	27.77	2.09	27.08	2.15	26.69	2.18	26.38	2.20	25.49	2.26		
55		51		28.48	2.00	28.01	2.05	27.49	2.10	27.18	2.13	26.92	2.14	26.13	2.19		
60		56		28.62	1.98	28.25	2.02	27.90	2.06	27.66	2.07	27.47	2.09	26.77	2.12		
63		59		28.70	1.97	28.39	2.00	28.14	2.03	27.95	2.04	27.80	2.05	27.15	2.07		
68		64		28.79	1.96	28.53	1.98	28.39	2.00	28.25	2.01	28.13	2.01	27.54	2.03		

TC = Total Capacity (kBtu/h).

PI = Power Input (kW).

Nominal capacity as rated: 0 ft. above sea level with 25 ft. of refrigerant piping.  
0 ft. level difference between outdoor and indoor units.

Nominal heating capacity rating obtained with air entering the indoor unit at 70°F dry bulb (DB) and 60°F wet bulb (WB), and outdoor ambient conditions of 47°F dry bulb (DB) and 43°F wet bulb (WB).

# PERFORMANCE DATA

## Heating Capacity Tables

MULTI F  
MULTI F MAX

Table 80: LMU247HV Heating Capacity Table — Non-Ducted Indoor Units (continued) / Ducted Indoor Units.

Connected Indoor Units	Combination Capacity Index	Outdoor Air Temp.		Indoor Air Temp. °F DB												
		°F DB	°F WB	61		64		68		70		72		75		
				TC	PI	TC	PI	TC	PI	TC	PI	TC	PI	TC	PI	
Three (3) Non-Ducted Indoor Units	9 + 9 + 12	0	-0.4	11.20	1.64	10.52	1.70	10.55	1.73	10.30	1.74	10.11	1.75	9.68	1.82	
		5	4.5	13.87	1.66	13.22	1.72	13.03	1.76	12.75	1.78	12.53	1.80	12.03	1.86	
		10	9	15.66	1.69	15.02	1.75	14.69	1.79	14.40	1.82	14.16	1.84	13.60	1.89	
		17	15	17.63	1.72	17.01	1.78	16.52	1.83	<b>16.20</b>	<b>1.86</b>	15.94	1.89	15.33	1.94	
		20	19	18.82	1.74	18.22	1.80	17.63	1.86	17.29	1.89	17.02	1.92	16.38	1.97	
		25	23	20.80	1.79	20.19	1.84	19.49	1.91	19.12	1.95	18.82	1.98	18.11	2.03	
		30	28	22.80	1.84	22.09	1.90	21.33	1.96	20.94	2.00	20.63	2.03	19.87	2.08	
		35	32	24.79	1.89	24.00	1.95	23.18	2.00	22.76	2.05	22.43	2.09	21.62	2.14	
		40	36	26.05	1.94	25.32	2.01	24.51	2.07	24.09	2.11	23.75	2.14	22.89	2.20	
		45	41	27.63	2.01	26.97	2.08	26.17	2.14	25.74	2.18	25.39	2.21	24.47	2.28	
		47	43	28.26	2.04	27.63	2.11	26.84	2.17	<b>26.40</b>	<b>2.21</b>	26.05	2.24	25.10	2.31	
		50	46	28.34	2.03	27.77	2.09	27.08	2.15	26.69	2.18	26.38	2.20	25.49	2.26	
		55	51	28.48	2.00	28.01	2.05	27.49	2.10	27.18	2.13	26.92	2.14	26.13	2.19	
		60	56	28.62	1.98	28.25	2.02	27.90	2.06	27.66	2.07	27.47	2.09	26.77	2.12	
		63	59	28.70	1.97	28.39	2.00	28.14	2.03	27.95	2.04	27.80	2.05	27.15	2.07	
		68	64	28.79	1.96	28.53	1.98	28.39	2.00	28.25	2.01	28.13	2.01	27.54	2.03	
		0	-0.4	11.20	1.64	10.52	1.70	10.55	1.73	10.30	1.74	10.11	1.75	9.68	1.82	
		5	4.5	13.87	1.66	13.22	1.72	13.03	1.76	12.75	1.78	12.53	1.80	12.03	1.86	
	10	9	15.66	1.69	15.02	1.75	14.69	1.79	14.40	1.82	14.16	1.84	13.60	1.89		
	17	15	17.63	1.72	17.01	1.78	16.52	1.83	<b>16.20</b>	<b>1.86</b>	15.94	1.89	15.33	1.94		
	20	19	18.82	1.74	18.22	1.80	17.63	1.86	17.29	1.89	17.02	1.92	16.38	1.97		
	25	23	20.80	1.79	20.19	1.84	19.49	1.91	19.12	1.95	18.82	1.98	18.11	2.03		
	30	28	22.80	1.84	22.09	1.90	21.33	1.96	20.94	2.00	20.63	2.03	19.87	2.08		
	35	32	24.79	1.89	24.00	1.95	23.18	2.00	22.76	2.05	22.43	2.09	21.62	2.14		
	40	36	26.05	1.94	25.32	2.01	24.51	2.07	24.09	2.11	23.75	2.14	22.89	2.20		
	45	41	27.63	2.01	26.97	2.08	26.17	2.14	25.74	2.18	25.39	2.21	24.47	2.28		
	47	43	28.26	2.04	27.63	2.11	26.84	2.17	<b>26.40</b>	<b>2.21</b>	26.05	2.24	25.10	2.31		
	50	46	28.34	2.03	27.77	2.09	27.08	2.15	26.69	2.18	26.38	2.20	25.49	2.26		
	55	51	28.48	2.00	28.01	2.05	27.49	2.10	27.18	2.13	26.92	2.14	26.13	2.19		
	60	56	28.62	1.98	28.25	2.02	27.90	2.06	27.66	2.07	27.47	2.09	26.77	2.12		
	63	59	28.70	1.97	28.39	2.00	28.14	2.03	27.95	2.04	27.80	2.05	27.15	2.07		
	68	64	28.79	1.96	28.53	1.98	28.39	2.00	28.25	2.01	28.13	2.01	27.54	2.03		
	Two (2) Ducted Indoor Units	9 + 9	0	-0.4	9.00	1.46	8.45	1.52	8.47	1.54	8.27	1.56	8.12	1.57	7.77	1.62
			5	4.5	10.92	1.49	10.41	1.54	10.26	1.57	10.04	1.59	9.86	1.61	9.47	1.66
			10	9	12.21	1.51	11.71	1.56	11.45	1.60	11.22	1.62	11.03	1.64	10.60	1.69
			17	15	13.62	1.54	13.15	1.59	12.77	1.64	<b>12.52</b>	<b>1.66</b>	12.32	1.69	11.84	1.73
20			19	14.48	1.56	14.02	1.60	13.57	1.66	13.31	1.69	13.10	1.72	12.60	1.76	
25			23	15.91	1.59	15.44	1.64	14.90	1.70	14.62	1.74	14.39	1.76	13.85	1.81	
30			28	17.34	1.64	16.81	1.69	16.23	1.74	15.93	1.78	15.69	1.81	15.12	1.86	
35			32	18.78	1.68	18.18	1.74	17.56	1.79	17.24	1.83	16.99	1.86	16.38	1.91	
40			36	19.73	1.73	19.18	1.79	18.57	1.84	18.25	1.88	17.99	1.91	17.34	1.96	
45			41	20.93	1.79	20.43	1.85	19.83	1.91	19.50	1.94	19.24	1.97	18.54	2.03	
47			43	21.41	1.82	20.93	1.88	20.33	1.94	<b>20.00</b>	<b>1.97</b>	19.73	2.00	19.02	2.06	
50			46	21.47	1.81	21.04	1.86	20.52	1.91	20.22	1.94	19.98	1.96	19.31	2.02	
55			51	21.58	1.79	21.22	1.83	20.83	1.87	20.59	1.89	20.40	1.91	19.79	1.95	
60			56	21.68	1.77	21.40	1.80	21.14	1.83	20.95	1.85	20.81	1.86	20.28	1.89	
63			59	21.74	1.76	21.51	1.78	21.32	1.81	21.18	1.82	21.06	1.83	20.57	1.85	
68			64	21.81	1.74	21.62	1.77	21.51	1.79	21.40	1.79	21.31	1.80	20.86	1.81	

TC = Total Capacity (kBtu/h).

PI = Power Input (kW).

Nominal capacity as rated: 0 ft. above sea level with 25 ft. of refrigerant piping.  
0 ft. level difference between outdoor and indoor units.

Nominal heating capacity rating obtained with air entering the indoor unit at 70°F dry bulb (DB) and 60°F wet bulb (WB), and outdoor ambient conditions of 47°F dry bulb (DB) and 43°F wet bulb (WB).



Table 81: LMU247HV Heating Capacity Table — Ducted Indoor Units (continued).

Connected Indoor Units	Combination Capacity Index	Outdoor Air Temp.		Indoor Air Temp. °F DB											
		°F DB	°F WB	61		64		68		70		72		75	
				TC	PI	TC	PI	TC	PI	TC	PI	TC	PI	TC	PI
Two (2) Ducted Indoor Units	9 + 12	0	-0.4	10.25	1.66	9.64	1.72	9.65	1.75	9.43	1.76	9.25	1.78	8.86	1.84
		5	4.5	12.45	1.68	11.86	1.74	11.69	1.78	11.44	1.80	11.24	1.82	10.79	1.88
		10	9	13.91	1.71	13.35	1.77	13.06	1.81	12.79	1.84	12.58	1.86	12.08	1.92
		17	15	15.53	1.74	14.99	1.80	14.56	1.85	<b>14.27</b>	<b>1.88</b>	14.04	1.91	13.50	1.96
		20	19	16.51	1.76	15.98	1.82	15.47	1.88	15.17	1.91	14.93	1.94	14.36	2.00
		25	23	18.14	1.80	17.60	1.86	16.99	1.93	16.67	1.97	16.41	2.00	15.79	2.05
		30	28	19.77	1.85	19.16	1.92	18.50	1.97	18.16	2.02	17.89	2.05	17.23	2.10
		35	32	21.41	1.90	20.72	1.97	20.02	2.02	19.66	2.07	19.37	2.11	18.67	2.16
		40	36	22.50	1.96	21.86	2.03	21.17	2.08	20.80	2.13	20.51	2.16	19.76	2.22
		45	41	23.86	2.03	23.29	2.10	22.60	2.16	22.23	2.20	21.93	2.23	21.13	2.30
		47	43	24.41	2.06	23.86	2.12	23.18	2.19	<b>22.80</b>	<b>2.23</b>	22.50	2.26	21.68	2.33
		50	46	24.48	2.04	23.98	2.10	23.39	2.17	23.05	2.20	22.78	2.22	22.01	2.28
	55	51	24.60	2.02	24.19	2.07	23.74	2.12	23.47	2.14	23.25	2.16	22.56	2.21	
	60	56	24.72	2.00	24.39	2.04	24.09	2.08	23.89	2.09	23.72	2.10	23.12	2.14	
	63	59	24.79	1.99	24.52	2.02	24.31	2.05	24.14	2.06	24.01	2.07	23.45	2.09	
	68	64	24.86	1.97	24.64	2.00	24.52	2.02	24.39	2.03	24.29	2.03	23.79	2.05	
	12 + 12	0	-0.4	11.78	1.75	11.08	1.82	11.09	1.85	10.84	1.87	10.63	1.88	10.18	1.95
		5	4.5	14.30	1.78	13.63	1.85	13.44	1.89	13.15	1.91	12.92	1.92	12.40	1.99
		10	9	15.99	1.81	15.34	1.87	15.00	1.92	14.70	1.94	14.45	1.97	13.88	2.03
		17	15	17.84	1.84	17.22	1.90	16.73	1.96	<b>16.40</b>	<b>1.99</b>	16.14	2.02	15.52	2.08
		20	19	18.97	1.87	18.36	1.92	17.77	1.99	17.43	2.03	17.16	2.06	16.51	2.11
		25	23	20.84	1.91	20.22	1.97	19.52	2.04	19.15	2.08	18.86	2.11	18.15	2.17
		30	28	22.72	1.96	22.02	2.03	21.26	2.09	20.87	2.14	20.56	2.17	19.80	2.23
		35	32	24.60	2.01	23.82	2.09	23.00	2.14	22.59	2.19	22.26	2.23	21.46	2.28
		40	36	25.85	2.07	25.13	2.15	24.32	2.21	23.90	2.25	23.57	2.29	22.71	2.35
		45	41	27.42	2.15	26.76	2.22	25.98	2.29	25.54	2.33	25.20	2.36	24.28	2.43
		47	43	28.05	2.18	27.42	2.25	26.64	2.32	<b>26.20</b>	<b>2.36</b>	25.85	2.39	24.91	2.46
		50	46	28.13	2.16	27.56	2.23	26.88	2.29	26.49	2.33	26.18	2.35	25.29	2.42
	55	51	28.27	2.14	27.80	2.19	27.28	2.24	26.97	2.27	26.72	2.29	25.93	2.34	
	60	56	28.40	2.12	28.03	2.16	27.69	2.20	27.45	2.21	27.26	2.23	26.56	2.26	
	63	59	28.48	2.10	28.17	2.14	27.93	2.17	27.74	2.18	27.59	2.19	26.95	2.21	
	68	64	28.57	2.09	28.32	2.12	28.18	2.14	28.03	2.15	27.92	2.15	27.33	2.17	
	9 + 18	0	-0.4	11.78	1.75	11.08	1.82	11.09	1.85	10.84	1.87	10.63	1.88	10.18	1.95
		5	4.5	14.30	1.78	13.63	1.85	13.44	1.89	13.15	1.91	12.92	1.92	12.40	1.99
		10	9	15.99	1.81	15.34	1.87	15.00	1.92	14.70	1.94	14.45	1.97	13.88	2.03
		17	15	17.84	1.84	17.22	1.90	16.73	1.96	<b>16.40</b>	<b>1.99</b>	16.14	2.02	15.52	2.08
		20	19	18.97	1.87	18.36	1.92	17.77	1.99	17.43	2.03	17.16	2.06	16.51	2.11
		25	23	20.84	1.91	20.22	1.97	19.52	2.04	19.15	2.08	18.86	2.11	18.15	2.17
		30	28	22.72	1.96	22.02	2.03	21.26	2.09	20.87	2.14	20.56	2.17	19.80	2.23
		35	32	24.60	2.01	23.82	2.09	23.00	2.14	22.59	2.19	22.26	2.23	21.46	2.28
		40	36	25.85	2.07	25.13	2.15	24.32	2.21	23.90	2.25	23.57	2.29	22.71	2.35
		45	41	27.42	2.15	26.76	2.22	25.98	2.29	25.54	2.33	25.20	2.36	24.28	2.43
		47	43	28.05	2.18	27.42	2.25	26.64	2.32	<b>26.20</b>	<b>2.36</b>	25.85	2.39	24.91	2.46
		50	46	28.13	2.16	27.56	2.23	26.88	2.29	26.49	2.33	26.18	2.35	25.29	2.42
	55	51	28.27	2.14	27.80	2.19	27.28	2.24	26.97	2.27	26.72	2.29	25.93	2.34	
	60	56	28.40	2.12	28.03	2.16	27.69	2.20	27.45	2.21	27.26	2.23	26.56	2.26	
	63	59	28.48	2.10	28.17	2.14	27.93	2.17	27.74	2.18	27.59	2.19	26.95	2.21	
	68	64	28.57	2.09	28.32	2.12	28.18	2.14	28.03	2.15	27.92	2.15	27.33	2.17	

TC = Total Capacity (kBtu/h).

PI = Power Input (kW).

Nominal capacity as rated: 0 ft. above sea level with 25 ft. of refrigerant piping.  
0 ft. level difference between outdoor and indoor units.

Nominal heating capacity rating obtained with air entering the indoor unit at 70°F dry bulb (DB) and 60°F wet bulb (WB), and outdoor ambient conditions of 47°F dry bulb (DB) and 43°F wet bulb (WB).

# PERFORMANCE DATA

## Heating Capacity Tables

MULTI F  
MULTI F MAX

Table 82: LMU247HV Heating Capacity Table — Ducted Indoor Units (continued).

Connected Indoor Units	Combination Capacity Index	Outdoor Air Temp.		Indoor Air Temp. °F DB											
		°F DB	°F WB	61		64		68		70		72		75	
				TC	PI	TC	PI	TC	PI	TC	PI	TC	PI	TC	PI
Two (2) Ducted Indoor Units	12 + 18	0	-0.4	11.78	1.75	11.08	1.82	11.09	1.85	10.84	1.87	10.63	1.88	10.18	1.95
		5	4.5	14.30	1.78	13.63	1.85	13.44	1.89	13.15	1.91	12.92	1.92	12.40	1.99
		10	9	15.99	1.81	15.34	1.87	15.00	1.92	14.70	1.94	14.45	1.97	13.88	2.03
		17	15	17.84	1.84	17.22	1.90	16.73	1.96	<b>16.40</b>	<b>1.99</b>	16.14	2.02	15.52	2.08
		20	19	18.97	1.87	18.36	1.92	17.77	1.99	17.43	2.03	17.16	2.06	16.51	2.11
		25	23	20.84	1.91	20.22	1.97	19.52	2.04	19.15	2.08	18.86	2.11	18.15	2.17
		30	28	22.72	1.96	22.02	2.03	21.26	2.09	20.87	2.14	20.56	2.17	19.80	2.23
		35	32	24.60	2.01	23.82	2.09	23.00	2.14	22.59	2.19	22.26	2.23	21.46	2.28
		40	36	25.85	2.07	25.13	2.15	24.32	2.21	23.90	2.25	23.57	2.29	22.71	2.35
		45	41	27.42	2.15	26.76	2.22	25.98	2.29	25.54	2.33	25.20	2.36	24.28	2.43
		47	43	28.05	2.18	27.42	2.25	26.64	2.32	<b>26.20</b>	<b>2.36</b>	25.85	2.39	24.91	2.46
		50	46	28.13	2.16	27.56	2.23	26.88	2.29	26.49	2.33	26.18	2.35	25.29	2.42
		55	51	28.27	2.14	27.80	2.19	27.28	2.24	26.97	2.27	26.72	2.29	25.93	2.34
		60	56	28.40	2.12	28.03	2.16	27.69	2.20	27.45	2.21	27.26	2.23	26.56	2.26
		63	59	28.48	2.10	28.17	2.14	27.93	2.17	27.74	2.18	27.59	2.19	26.95	2.21
68	64	28.57	2.09	28.32	2.12	28.18	2.14	28.03	2.15	27.92	2.15	27.33	2.17		
Three (3) Ducted Indoor Units	9 + 9 + 9	0	-0.4	11.78	1.66	11.08	1.72	11.09	1.75	10.84	1.76	10.63	1.78	10.18	1.84
		5	4.5	14.30	1.68	13.63	1.74	13.44	1.78	13.15	1.80	12.92	1.82	12.40	1.88
		10	9	15.99	1.71	15.34	1.77	15.00	1.81	14.70	1.84	14.45	1.86	13.88	1.92
		17	15	17.84	1.74	17.22	1.80	16.73	1.85	<b>16.40</b>	<b>1.88</b>	16.14	1.91	15.52	1.96
		20	19	18.97	1.76	18.36	1.82	17.77	1.88	17.43	1.91	17.16	1.94	16.51	2.00
		25	23	20.84	1.80	20.22	1.86	19.52	1.93	19.15	1.97	18.86	2.00	18.15	2.05
		30	28	22.72	1.85	22.02	1.92	21.26	1.97	20.87	2.02	20.56	2.05	19.80	2.10
		35	32	24.60	1.90	23.82	1.97	23.00	2.02	22.59	2.07	22.26	2.11	21.46	2.16
		40	36	25.85	1.96	25.13	2.03	24.32	2.08	23.90	2.13	23.57	2.16	22.71	2.22
		45	41	27.42	2.03	26.76	2.10	25.98	2.16	25.54	2.20	25.20	2.23	24.28	2.30
		47	43	28.05	2.06	27.42	2.12	26.64	2.19	<b>26.20</b>	<b>2.23</b>	25.85	2.26	24.91	2.33
		50	46	28.13	2.04	27.56	2.10	26.88	2.17	26.49	2.20	26.18	2.22	25.29	2.28
		55	51	28.27	2.02	27.80	2.07	27.28	2.12	26.97	2.14	26.72	2.16	25.93	2.21
		60	56	28.40	2.00	28.03	2.04	27.69	2.08	27.45	2.09	27.26	2.10	26.56	2.14
		63	59	28.48	1.99	28.17	2.02	27.93	2.05	27.74	2.06	27.59	2.07	26.95	2.09
	68	64	28.57	1.97	28.32	2.00	28.18	2.02	28.03	2.03	27.92	2.03	27.33	2.05	
	9 + 9 + 12	0	-0.4	11.78	1.66	11.08	1.72	11.09	1.75	10.84	1.76	10.63	1.78	10.18	1.84
		5	4.5	14.30	1.68	13.63	1.74	13.44	1.78	13.15	1.80	12.92	1.82	12.40	1.88
		10	9	15.99	1.71	15.34	1.77	15.00	1.81	14.70	1.84	14.45	1.86	13.88	1.92
		17	15	17.84	1.74	17.22	1.80	16.73	1.85	<b>16.40</b>	<b>1.88</b>	16.14	1.91	15.52	1.96
		20	19	18.97	1.76	18.36	1.82	17.77	1.88	17.43	1.91	17.16	1.94	16.51	2.00
		25	23	20.84	1.80	20.22	1.86	19.52	1.93	19.15	1.97	18.86	2.00	18.15	2.05
		30	28	22.72	1.85	22.02	1.92	21.26	1.97	20.87	2.02	20.56	2.05	19.80	2.10
		35	32	24.60	1.90	23.82	1.97	23.00	2.02	22.59	2.07	22.26	2.11	21.46	2.16
		40	36	25.85	1.96	25.13	2.03	24.32	2.08	23.90	2.13	23.57	2.16	22.71	2.22
		45	41	27.42	2.03	26.76	2.10	25.98	2.16	25.54	2.20	25.20	2.23	24.28	2.30
		47	43	28.05	2.06	27.42	2.12	26.64	2.19	<b>26.20</b>	<b>2.23</b>	25.85	2.26	24.91	2.33
		50	46	28.13	2.04	27.56	2.10	26.88	2.17	26.49	2.20	26.18	2.22	25.29	2.28
		55	51	28.27	2.02	27.80	2.07	27.28	2.12	26.97	2.14	26.72	2.16	25.93	2.21
		60	56	28.40	2.00	28.03	2.04	27.69	2.08	27.45	2.09	27.26	2.10	26.56	2.14
63		59	28.48	1.99	28.17	2.02	27.93	2.05	27.74	2.06	27.59	2.07	26.95	2.09	
68	64	28.57	1.97	28.32	2.00	28.18	2.02	28.03	2.03	27.92	2.03	27.33	2.05		

TC = Total Capacity (kBtu/h).

PI = Power Input (kW).

Nominal capacity as rated: 0 ft. above sea level with 25 ft. of refrigerant piping.  
0 ft. level difference between outdoor and indoor units.

Nominal heating capacity rating obtained with air entering the indoor unit at 70°F dry bulb (DB) and 60°F wet bulb (WB), and outdoor ambient conditions of 47°F dry bulb (DB) and 43°F wet bulb (WB).



Multi F and Multi F MAX Heat Pump System Engineering Manual

Table 83: LMU247HV Heating Capacity Table — Ducted Indoor Units (continued) / Mixed Indoor Units.

Connected Indoor Units	Combination Capacity Index	Outdoor Air Temp.		Indoor Air Temp. °F DB											
		°F DB	°F WB	61		64		68		70		72		75	
				TC	PI	TC	PI	TC	PI	TC	PI	TC	PI	TC	PI
Three (3) Ducted Indoor Units	9 + 12 + 12	0	-0.4	11.78	1.66	11.08	1.72	11.09	1.75	10.84	1.76	10.63	1.78	10.18	1.84
		5	4.5	14.30	1.68	13.63	1.74	13.44	1.78	13.15	1.80	12.92	1.82	12.40	1.88
		10	9	15.99	1.71	15.34	1.77	15.00	1.81	14.70	1.84	14.45	1.86	13.88	1.92
		17	15	17.84	1.74	17.22	1.80	16.73	1.85	<b>16.40</b>	<b>1.88</b>	16.14	1.91	15.52	1.96
		20	19	18.97	1.76	18.36	1.82	17.77	1.88	17.43	1.91	17.16	1.94	16.51	2.00
		25	23	20.84	1.80	20.22	1.86	19.52	1.93	19.15	1.97	18.86	2.00	18.15	2.05
		30	28	22.72	1.85	22.02	1.92	21.26	1.97	20.87	2.02	20.56	2.05	19.80	2.10
		35	32	24.60	1.90	23.82	1.97	23.00	2.02	22.59	2.07	22.26	2.11	21.46	2.16
		40	36	25.85	1.96	25.13	2.03	24.32	2.08	23.90	2.13	23.57	2.16	22.71	2.22
		45	41	27.42	2.03	26.76	2.10	25.98	2.16	25.54	2.20	25.20	2.23	24.28	2.30
		47	43	28.05	2.06	27.42	2.12	26.64	2.19	<b>26.20</b>	<b>2.23</b>	25.85	2.26	24.91	2.33
		50	46	28.13	2.04	27.56	2.10	26.88	2.17	26.49	2.20	26.18	2.22	25.29	2.28
		55	51	28.27	2.02	27.80	2.07	27.28	2.12	26.97	2.14	26.72	2.16	25.93	2.21
		60	56	28.40	2.00	28.03	2.04	27.69	2.08	27.45	2.09	27.26	2.10	26.56	2.14
		63	59	28.48	1.99	28.17	2.02	27.93	2.05	27.74	2.06	27.59	2.07	26.95	2.09
		68	64	28.57	1.97	28.32	2.00	28.18	2.02	28.03	2.03	27.92	2.03	27.33	2.05
Two (2) Mixed Indoor Units	9 + 9	0	-0.4	8.79	1.45	8.26	1.51	8.28	1.53	8.09	1.55	7.93	1.56	7.60	1.61
		5	4.5	10.78	1.48	10.27	1.53	10.12	1.56	9.91	1.58	9.74	1.60	9.34	1.65
		10	9	12.11	1.50	11.62	1.55	11.36	1.59	11.13	1.61	10.94	1.63	10.51	1.68
		17	15	13.57	1.53	13.10	1.58	12.72	1.63	<b>12.47</b>	<b>1.65</b>	12.27	1.67	11.80	1.72
		20	19	14.45	1.55	13.99	1.60	13.54	1.65	13.28	1.68	13.07	1.71	12.58	1.75
		25	23	15.93	1.58	15.46	1.63	14.92	1.69	14.64	1.73	14.41	1.75	13.87	1.80
		30	28	17.41	1.63	16.87	1.68	16.29	1.73	15.99	1.77	15.75	1.80	15.17	1.85
		35	32	18.89	1.67	18.29	1.73	17.67	1.78	17.35	1.82	17.09	1.85	16.48	1.90
		40	36	19.85	1.72	19.29	1.78	18.68	1.83	18.36	1.87	18.10	1.90	17.44	1.95
		45	41	21.06	1.78	20.55	1.84	19.95	1.90	19.62	1.93	19.35	1.96	18.65	2.02
		47	43	21.54	1.81	21.06	1.87	20.45	1.93	<b>20.12</b>	<b>1.96</b>	19.85	1.99	19.13	2.05
		50	46	21.60	1.80	21.16	1.85	20.64	1.90	20.34	1.93	20.10	1.95	19.42	2.01
		55	51	21.71	1.78	21.35	1.82	20.95	1.86	20.71	1.89	20.52	1.90	19.91	1.94
		60	56	21.81	1.76	21.53	1.79	21.26	1.82	21.08	1.84	20.94	1.85	20.40	1.88
		63	59	21.87	1.75	21.64	1.77	21.45	1.80	21.30	1.81	21.18	1.82	20.69	1.84
		68	64	21.94	1.74	21.75	1.76	21.64	1.78	21.53	1.78	21.44	1.79	20.99	1.80
	9 + 12	0	-0.4	10.01	1.63	9.40	1.69	9.42	1.72	9.20	1.74	9.03	1.75	8.65	1.81
		5	4.5	12.27	1.66	11.69	1.72	11.52	1.75	11.28	1.77	11.08	1.79	10.63	1.85
		10	9	13.78	1.68	13.22	1.74	12.93	1.78	12.67	1.81	12.46	1.83	11.96	1.89
		17	15	15.44	1.72	14.91	1.77	14.48	1.83	<b>14.19</b>	<b>1.86</b>	13.97	1.88	13.43	1.93
		20	19	16.45	1.74	15.93	1.79	15.41	1.85	15.12	1.89	14.88	1.91	14.32	1.97
		25	23	18.13	1.78	17.59	1.83	16.98	1.90	16.66	1.94	16.40	1.97	15.79	2.02
		30	28	19.82	1.83	19.20	1.89	18.54	1.95	18.20	1.99	17.93	2.02	17.27	2.08
		35	32	21.50	1.88	20.82	1.94	20.11	2.00	19.75	2.04	19.46	2.08	18.75	2.13
		40	36	22.60	1.93	21.96	2.00	21.26	2.06	20.89	2.10	20.60	2.13	19.85	2.19
		45	41	23.97	2.00	23.39	2.07	22.70	2.13	22.33	2.17	22.02	2.20	21.22	2.27
		47	43	24.51	2.03	23.97	2.10	23.28	2.16	<b>22.90</b>	<b>2.20</b>	22.60	2.23	21.77	2.30
		50	46	24.58	2.02	24.09	2.08	23.49	2.14	23.15	2.17	22.88	2.19	22.11	2.25
		55	51	24.70	1.99	24.30	2.04	23.85	2.09	23.57	2.12	23.35	2.14	22.66	2.18
		60	56	24.82	1.97	24.50	2.01	24.20	2.05	23.99	2.06	23.83	2.08	23.22	2.11
		63	59	24.90	1.96	24.63	1.99	24.41	2.02	24.25	2.03	24.11	2.04	23.55	2.06
		68	64	24.97	1.95	24.75	1.97	24.63	2.00	24.50	2.00	24.40	2.01	23.89	2.02

TC = Total Capacity (kBtu/h).

PI = Power Input (kW).

Nominal capacity as rated: 0 ft. above sea level with 25 ft. of refrigerant piping.  
0 ft. level difference between outdoor and indoor units.

Nominal heating capacity rating obtained with air entering the indoor unit at 70°F dry bulb (DB) and 60°F wet bulb (WB), and outdoor ambient conditions of 47°F dry bulb (DB) and 43°F wet bulb (WB).

# PERFORMANCE DATA

## Heating Capacity Tables

MULTI F  
MULTI F MAX

Table 84: LMU247HV Heating Capacity Table — Mixed Indoor Units (continued).

Connected Indoor Units	Combination Capacity Index	Outdoor Air Temp.		Indoor Air Temp. °F DB											
		°F DB	°F WB	61		64		68		70		72		75	
				TC	PI	TC	PI	TC	PI	TC	PI	TC	PI	TC	PI
Two (2) Mixed Indoor Units	12 + 12	0	-0.4	11.49	1.74	10.80	1.80	10.82	1.83	10.57	1.85	10.37	1.86	9.93	1.93
		5	4.5	14.09	1.76	13.42	1.83	13.23	1.87	12.95	1.89	12.73	1.90	12.21	1.97
		10	9	15.82	1.79	15.18	1.85	14.85	1.90	14.55	1.92	14.30	1.95	13.74	2.01
		17	15	17.74	1.82	17.12	1.88	16.63	1.94	<b>16.30</b>	<b>1.97</b>	16.04	2.00	15.42	2.06
		20	19	18.89	1.85	18.29	1.90	17.70	1.97	17.36	2.01	17.09	2.04	16.44	2.09
		25	23	20.82	1.89	20.21	1.95	19.50	2.02	19.13	2.06	18.84	2.09	18.13	2.15
		30	28	22.76	1.95	22.05	2.01	21.30	2.07	20.91	2.12	20.59	2.15	19.84	2.21
		35	32	24.69	2.00	23.91	2.07	23.09	2.12	22.68	2.17	22.34	2.21	21.54	2.26
		40	36	25.95	2.06	25.22	2.13	24.42	2.19	23.99	2.23	23.66	2.27	22.80	2.33
		45	41	27.52	2.13	26.87	2.20	26.07	2.27	25.64	2.31	25.29	2.34	24.38	2.41
		47	43	28.15	2.16	27.52	2.23	26.74	2.30	<b>26.30</b>	<b>2.34</b>	25.95	2.37	25.01	2.44
		50	46	28.24	2.14	27.67	2.21	26.98	2.27	26.59	2.31	26.28	2.33	25.39	2.40
		55	51	28.37	2.12	27.90	2.17	27.39	2.23	27.07	2.25	26.82	2.27	26.03	2.32
		60	56	28.51	2.10	28.14	2.14	27.79	2.18	27.56	2.19	27.37	2.21	26.67	2.24
		63	59	28.59	2.09	28.28	2.12	28.04	2.15	27.85	2.16	27.69	2.17	27.05	2.20
		68	64	28.68	2.07	28.42	2.10	28.28	2.12	28.14	2.13	28.02	2.13	27.44	2.15
	9 + 18	0	-0.4	11.49	1.74	10.80	1.80	10.82	1.83	10.57	1.85	10.37	1.86	9.93	1.93
		5	4.5	14.09	1.76	13.42	1.83	13.23	1.87	12.95	1.89	12.73	1.90	12.21	1.97
		10	9	15.82	1.79	15.18	1.85	14.85	1.90	14.55	1.92	14.30	1.95	13.74	2.01
		17	15	17.74	1.82	17.12	1.88	16.63	1.94	<b>16.30</b>	<b>1.97</b>	16.04	2.00	15.42	2.06
		20	19	18.89	1.85	18.29	1.90	17.70	1.97	17.36	2.01	17.09	2.04	16.44	2.09
		25	23	20.82	1.89	20.21	1.95	19.50	2.02	19.13	2.06	18.84	2.09	18.13	2.15
		30	28	22.76	1.95	22.05	2.01	21.30	2.07	20.91	2.12	20.59	2.15	19.84	2.21
		35	32	24.69	2.00	23.91	2.07	23.09	2.12	22.68	2.17	22.34	2.21	21.54	2.26
		40	36	25.95	2.06	25.22	2.13	24.42	2.19	23.99	2.23	23.66	2.27	22.80	2.33
		45	41	27.52	2.13	26.87	2.20	26.07	2.27	25.64	2.31	25.29	2.34	24.38	2.41
		47	43	28.15	2.16	27.52	2.23	26.74	2.30	<b>26.30</b>	<b>2.34</b>	25.95	2.37	25.01	2.44
		50	46	28.24	2.14	27.67	2.21	26.98	2.27	26.59	2.31	26.28	2.33	25.39	2.40
		55	51	28.37	2.12	27.90	2.17	27.39	2.23	27.07	2.25	26.82	2.27	26.03	2.32
		60	56	28.51	2.10	28.14	2.14	27.79	2.18	27.56	2.19	27.37	2.21	26.67	2.24
		63	59	28.59	2.09	28.28	2.12	28.04	2.15	27.85	2.16	27.69	2.17	27.05	2.20
		68	64	28.68	2.07	28.42	2.10	28.28	2.12	28.14	2.13	28.02	2.13	27.44	2.15
	12 + 18	0	-0.4	11.49	1.74	10.80	1.80	10.82	1.83	10.57	1.85	10.37	1.86	9.93	1.93
		5	4.5	14.09	1.76	13.42	1.83	13.23	1.87	12.95	1.89	12.73	1.90	12.21	1.97
		10	9	15.82	1.79	15.18	1.85	14.85	1.90	14.55	1.92	14.30	1.95	13.74	2.01
		17	15	17.74	1.82	17.12	1.88	16.63	1.94	<b>16.30</b>	<b>1.97</b>	16.04	2.00	15.42	2.06
		20	19	18.89	1.85	18.29	1.90	17.70	1.97	17.36	2.01	17.09	2.04	16.44	2.09
		25	23	20.82	1.89	20.21	1.95	19.50	2.02	19.13	2.06	18.84	2.09	18.13	2.15
		30	28	22.76	1.95	22.05	2.01	21.30	2.07	20.91	2.12	20.59	2.15	19.84	2.21
		35	32	24.69	2.00	23.91	2.07	23.09	2.12	22.68	2.17	22.34	2.21	21.54	2.26
		40	36	25.95	2.06	25.22	2.13	24.42	2.19	23.99	2.23	23.66	2.27	22.80	2.33
		45	41	27.52	2.13	26.87	2.20	26.07	2.27	25.64	2.31	25.29	2.34	24.38	2.41
		47	43	28.15	2.16	27.52	2.23	26.74	2.30	<b>26.30</b>	<b>2.34</b>	25.95	2.37	25.01	2.44
		50	46	28.24	2.14	27.67	2.21	26.98	2.27	26.59	2.31	26.28	2.33	25.39	2.40
		55	51	28.37	2.12	27.90	2.17	27.39	2.23	27.07	2.25	26.82	2.27	26.03	2.32
		60	56	28.51	2.10	28.14	2.14	27.79	2.18	27.56	2.19	27.37	2.21	26.67	2.24
		63	59	28.59	2.09	28.28	2.12	28.04	2.15	27.85	2.16	27.69	2.17	27.05	2.20
		68	64	28.68	2.07	28.42	2.10	28.28	2.12	28.14	2.13	28.02	2.13	27.44	2.15

TC = Total Capacity (kBtu/h).

PI = Power Input (kW).

Nominal capacity as rated: 0 ft. above sea level with 25 ft. of refrigerant piping.  
0 ft. level difference between outdoor and indoor units.

Nominal heating capacity rating obtained with air entering the indoor unit at 70°F dry bulb (DB) and 60°F wet bulb (WB), and outdoor ambient conditions of 47°F dry bulb (DB) and 43°F wet bulb (WB).



Multi F and Multi F MAX Heat Pump System Engineering Manual

Table 85: LMU247HV Heating Capacity Table — Mixed Indoor Units (continued).

Connected Indoor Units	Combination Capacity Index	Outdoor Air Temp.		Indoor Air Temp. °F DB											
		°F DB	°F WB	61		64		68		70		72		75	
				TC	PI	TC	PI	TC	PI	TC	PI	TC	PI	TC	PI
Three (3) Mixed Indoor Units	9 + 9 + 9	0	-0.4	11.49	1.65	10.80	1.71	10.82	1.74	10.57	1.75	10.37	1.76	9.93	1.83
		5	4.5	14.09	1.67	13.42	1.73	13.23	1.77	12.95	1.79	12.73	1.81	12.21	1.87
		10	9	15.82	1.70	15.18	1.76	14.85	1.80	14.55	1.83	14.30	1.85	13.74	1.90
		17	15	17.74	1.73	17.12	1.79	16.63	1.84	16.30	1.87	16.04	1.90	15.42	1.95
		20	19	18.89	1.75	18.29	1.81	17.70	1.87	17.36	1.90	17.09	1.93	16.44	1.98
		25	23	20.82	1.80	20.21	1.85	19.50	1.92	19.13	1.96	18.84	1.99	18.13	2.04
		30	28	22.76	1.85	22.05	1.91	21.30	1.96	20.91	2.01	20.59	2.04	19.84	2.09
		35	32	24.69	1.89	23.91	1.96	23.09	2.01	22.68	2.06	22.34	2.10	21.54	2.15
		40	36	25.95	1.95	25.22	2.02	24.42	2.07	23.99	2.12	23.66	2.15	22.80	2.21
		45	41	27.52	2.02	26.87	2.09	26.07	2.15	25.64	2.19	25.29	2.22	24.38	2.29
		47	43	28.15	2.05	27.52	2.11	26.74	2.18	26.30	2.22	25.95	2.25	25.01	2.32
		50	46	28.24	2.03	27.67	2.10	26.98	2.16	26.59	2.19	26.28	2.21	25.39	2.27
		55	51	28.37	2.01	27.90	2.06	27.39	2.11	27.07	2.14	26.82	2.15	26.03	2.20
		60	56	28.51	1.99	28.14	2.03	27.79	2.07	27.56	2.08	27.37	2.09	26.67	2.13
		63	59	28.59	1.98	28.28	2.01	28.04	2.04	27.85	2.05	27.69	2.06	27.05	2.08
		68	64	28.68	1.97	28.42	1.99	28.28	2.01	28.14	2.02	28.02	2.02	27.44	2.04
	9 + 9 + 12	0	-0.4	11.49	1.65	10.80	1.71	10.82	1.74	10.57	1.75	10.37	1.76	9.93	1.83
		5	4.5	14.09	1.67	13.42	1.73	13.23	1.77	12.95	1.79	12.73	1.81	12.21	1.87
		10	9	15.82	1.70	15.18	1.76	14.85	1.80	14.55	1.83	14.30	1.85	13.74	1.90
		17	15	17.74	1.73	17.12	1.79	16.63	1.84	16.30	1.87	16.04	1.90	15.42	1.95
		20	19	18.89	1.75	18.29	1.81	17.70	1.87	17.36	1.90	17.09	1.93	16.44	1.98
		25	23	20.82	1.80	20.21	1.85	19.50	1.92	19.13	1.96	18.84	1.99	18.13	2.04
		30	28	22.76	1.85	22.05	1.91	21.30	1.96	20.91	2.01	20.59	2.04	19.84	2.09
		35	32	24.69	1.89	23.91	1.96	23.09	2.01	22.68	2.06	22.34	2.10	21.54	2.15
		40	36	25.95	1.95	25.22	2.02	24.42	2.07	23.99	2.12	23.66	2.15	22.80	2.21
		45	41	27.52	2.02	26.87	2.09	26.07	2.15	25.64	2.19	25.29	2.22	24.38	2.29
		47	43	28.15	2.05	27.52	2.11	26.74	2.18	26.30	2.22	25.95	2.25	25.01	2.32
		50	46	28.24	2.03	27.67	2.10	26.98	2.16	26.59	2.19	26.28	2.21	25.39	2.27
		55	51	28.37	2.01	27.90	2.06	27.39	2.11	27.07	2.14	26.82	2.15	26.03	2.20
		60	56	28.51	1.99	28.14	2.03	27.79	2.07	27.56	2.08	27.37	2.09	26.67	2.13
		63	59	28.59	1.98	28.28	2.01	28.04	2.04	27.85	2.05	27.69	2.06	27.05	2.08
		68	64	28.68	1.97	28.42	1.99	28.28	2.01	28.14	2.02	28.02	2.02	27.44	2.04
	9 + 12 + 12	0	-0.4	11.49	1.65	10.80	1.71	10.82	1.74	10.57	1.75	10.37	1.76	9.93	1.83
		5	4.5	14.09	1.67	13.42	1.73	13.23	1.77	12.95	1.79	12.73	1.81	12.21	1.87
		10	9	15.82	1.70	15.18	1.76	14.85	1.80	14.55	1.83	14.30	1.85	13.74	1.90
		17	15	17.74	1.73	17.12	1.79	16.63	1.84	16.30	1.87	16.04	1.90	15.42	1.95
		20	19	18.89	1.75	18.29	1.81	17.70	1.87	17.36	1.90	17.09	1.93	16.44	1.98
		25	23	20.82	1.80	20.21	1.85	19.50	1.92	19.13	1.96	18.84	1.99	18.13	2.04
		30	28	22.76	1.85	22.05	1.91	21.30	1.96	20.91	2.01	20.59	2.04	19.84	2.09
		35	32	24.69	1.89	23.91	1.96	23.09	2.01	22.68	2.06	22.34	2.10	21.54	2.15
		40	36	25.95	1.95	25.22	2.02	24.42	2.07	23.99	2.12	23.66	2.15	22.80	2.21
		45	41	27.52	2.02	26.87	2.09	26.07	2.15	25.64	2.19	25.29	2.22	24.38	2.29
		47	43	28.15	2.05	27.52	2.11	26.74	2.18	26.30	2.22	25.95	2.25	25.01	2.32
		50	46	28.24	2.03	27.67	2.10	26.98	2.16	26.59	2.19	26.28	2.21	25.39	2.27
		55	51	28.37	2.01	27.90	2.06	27.39	2.11	27.07	2.14	26.82	2.15	26.03	2.20
		60	56	28.51	1.99	28.14	2.03	27.79	2.07	27.56	2.08	27.37	2.09	26.67	2.13
		63	59	28.59	1.98	28.28	2.01	28.04	2.04	27.85	2.05	27.69	2.06	27.05	2.08
		68	64	28.68	1.97	28.42	1.99	28.28	2.01	28.14	2.02	28.02	2.02	27.44	2.04

TC = Total Capacity (kBtu/h).

PI = Power Input (kW).

Nominal capacity as rated: 0 ft. above sea level with 25 ft. of refrigerant piping.  
0 ft. level difference between outdoor and indoor units.

Nominal heating capacity rating obtained with air entering the indoor unit at 70°F dry bulb (DB) and 60°F wet bulb (WB), and outdoor ambient conditions of 47°F dry bulb (DB) and 43°F wet bulb (WB).

# PERFORMANCE DATA

## Heating Capacity Tables

MULTI F  
MULTI F MAX

Table 86: LMU369HV Heating Capacity Table — Non-Ducted Indoor Units.

Connected Indoor Units	Combination Capacity Index	Outdoor Air Temp.		Indoor Air Temp. °F DB											
		°F DB	°F WB	61		64		68		70		72		75	
				TC	PI	TC	PI	TC	PI	TC	PI	TC	PI	TC	PI
Two (2) Non-Ducted Indoor Units	9 + 9	0	-0.4	9.66	1.37	9.09	1.42	9.09	1.44	8.89	1.45	8.72	1.46	8.35	1.51
		5	4.5	11.58	1.41	11.04	1.46	10.88	1.49	10.65	1.51	10.46	1.52	10.04	1.58
		10	9	12.87	1.46	12.35	1.51	12.07	1.54	11.83	1.57	11.63	1.58	11.17	1.63
		17	15	14.28	1.51	13.79	1.56	13.39	1.61	<b>13.13</b>	<b>1.64</b>	12.92	1.66	12.42	1.71
		20	19	15.14	1.55	14.66	1.60	14.19	1.66	13.91	1.69	13.70	1.71	13.18	1.76
		25	23	16.57	1.62	16.08	1.67	15.52	1.73	15.23	1.77	14.99	1.80	14.43	1.84
		30	28	18.00	1.70	17.45	1.76	16.85	1.81	16.54	1.85	16.29	1.88	15.69	1.93
		35	32	19.43	1.78	18.82	1.84	18.17	1.89	17.85	1.93	17.59	1.97	16.95	2.01
		40	36	20.42	1.83	19.85	1.89	19.22	1.94	18.89	1.98	18.62	2.02	17.94	2.07
		45	41	21.66	1.89	21.15	1.96	20.52	2.02	20.18	2.05	19.91	2.08	19.19	2.14
		47	43	22.16	1.92	21.66	1.98	21.04	2.04	<b>20.70</b>	<b>2.08</b>	20.42	2.11	19.68	2.17
		50	46	22.22	1.91	21.77	1.96	21.24	2.02	20.93	2.05	20.68	2.07	19.98	2.13
		55	51	22.33	1.89	21.96	1.93	21.56	1.98	21.31	2.00	21.11	2.02	20.49	2.06
		60	56	22.44	1.87	22.15	1.90	21.88	1.94	21.69	1.95	21.54	1.96	20.99	1.99
		63	59	22.51	1.85	22.26	1.88	22.07	1.91	21.92	1.92	21.80	1.93	21.29	1.95
		68	64	22.57	1.84	22.37	1.87	22.26	1.89	22.15	1.89	22.06	1.90	21.59	1.91
	0	-0.4	11.27	1.67	10.60	1.73	10.61	1.76	10.37	1.77	10.17	1.78	9.74	1.85	
	5	4.5	13.51	1.73	12.88	1.79	12.69	1.82	12.42	1.84	12.21	1.86	11.71	1.92	
	10	9	15.01	1.78	14.41	1.84	14.09	1.89	13.80	1.91	13.57	1.93	13.04	1.99	
	17	15	16.66	1.85	16.08	1.91	15.62	1.97	<b>15.31</b>	<b>2.00</b>	15.07	2.03	14.49	2.09	
	20	19	17.66	1.90	17.10	1.96	16.55	2.02	16.23	2.06	15.98	2.09	15.37	2.15	
	25	23	19.33	1.98	18.76	2.04	18.11	2.12	17.76	2.16	17.49	2.19	16.83	2.25	
	30	28	21.00	2.08	20.35	2.14	19.65	2.21	19.29	2.26	19.00	2.30	18.31	2.35	
	35	32	22.67	2.17	21.95	2.25	21.20	2.30	20.82	2.36	20.52	2.40	19.78	2.46	
	40	36	23.83	2.23	23.16	2.31	22.42	2.37	22.03	2.42	21.72	2.46	20.94	2.53	
	45	41	25.27	2.31	24.67	2.39	23.94	2.46	23.55	2.51	23.23	2.54	22.38	2.62	
	47	43	25.85	2.34	25.27	2.42	24.55	2.50	<b>24.15</b>	<b>2.54</b>	23.83	2.57	22.96	2.65	
	50	46	25.93	2.33	25.40	2.40	24.78	2.47	24.42	2.50	24.13	2.53	23.31	2.60	
	55	51	26.05	2.30	25.62	2.36	25.15	2.42	24.86	2.44	24.63	2.47	23.90	2.52	
	60	56	26.18	2.28	25.84	2.32	25.52	2.36	25.30	2.38	25.13	2.40	24.49	2.43	
	63	59	26.26	2.26	25.97	2.30	25.75	2.33	25.57	2.35	25.43	2.36	24.84	2.38	
	68	64	26.33	2.25	26.10	2.28	25.97	2.30	25.84	2.31	25.73	2.32	25.19	2.33	
	0	-0.4	12.88	1.70	12.11	1.77	12.12	1.79	11.85	1.81	11.63	1.82	11.13	1.88	
	5	4.5	15.44	1.76	14.72	1.82	14.50	1.86	14.20	1.88	13.95	1.90	13.39	1.96	
	10	9	17.16	1.81	16.46	1.88	16.10	1.92	15.77	1.95	15.51	1.97	14.90	2.03	
	17	15	19.04	1.89	18.38	1.95	17.85	2.01	<b>17.50</b>	<b>2.04</b>	17.22	2.07	16.56	2.13	
	20	19	20.19	1.93	19.54	1.99	18.92	2.06	18.55	2.10	18.26	2.13	17.57	2.19	
	25	23	22.09	2.02	21.44	2.08	20.69	2.16	20.30	2.20	19.99	2.24	19.23	2.30	
	30	28	24.00	2.12	23.26	2.19	22.46	2.25	22.05	2.30	21.72	2.34	20.92	2.40	
	35	32	25.91	2.21	25.09	2.29	24.23	2.35	23.80	2.40	23.45	2.45	22.60	2.51	
	40	36	27.23	2.28	26.47	2.35	25.62	2.42	25.18	2.47	24.83	2.51	23.93	2.58	
	45	41	28.88	2.36	28.19	2.43	27.36	2.51	26.91	2.56	26.55	2.59	25.58	2.67	
	47	43	29.54	2.39	28.88	2.47	28.06	2.55	<b>27.60</b>	<b>2.59</b>	27.23	2.63	26.24	2.70	
	50	46	29.63	2.37	29.03	2.44	28.31	2.52	27.90	2.55	27.58	2.58	26.64	2.65	
	55	51	29.78	2.35	29.28	2.41	28.74	2.46	28.41	2.49	28.15	2.51	27.31	2.57	
	60	56	29.92	2.32	29.53	2.37	29.17	2.41	28.92	2.43	28.72	2.44	27.98	2.48	
	63	59	30.01	2.31	29.68	2.35	29.42	2.38	29.22	2.39	29.06	2.40	28.39	2.43	
	68	64	30.09	2.29	29.83	2.32	29.68	2.35	29.53	2.36	29.41	2.36	28.79	2.38	

TC = Total Capacity (kBtu/h).

PI = Power Input (kW).

Nominal capacity as rated: 0 ft. above sea level with 25 ft. of refrigerant piping.  
0 ft. level difference between outdoor and indoor units.

Nominal heating capacity rating obtained with air entering the indoor unit at 70°F dry bulb (DB) and 60°F wet bulb (WB), and outdoor ambient conditions of 47°F dry bulb (DB) and 43°F wet bulb (WB).



Multi F and Multi F MAX Heat Pump System Engineering Manual

Table 87: LMU369HV Heating Capacity Table — Non-Ducted Indoor Units.

Connected Indoor Units	Combination Capacity Index	Outdoor Air Temp.		Indoor Air Temp. °F DB											
		°F DB	°F WB	61		64		68		70		72		75	
				TC	PI	TC	PI	TC	PI	TC	PI	TC	PI	TC	PI
Two (2) Non-Ducted Indoor Units	9 + 18	0	-0.4	14.49	1.90	13.63	1.98	13.64	2.01	13.33	2.02	13.08	2.04	12.52	2.11
		5	4.5	17.37	1.97	16.56	2.04	16.32	2.08	15.97	2.11	15.70	2.12	15.06	2.20
		10	9	19.30	2.03	18.52	2.10	18.11	2.15	17.74	2.18	17.45	2.21	16.76	2.28
		17	15	21.42	2.11	20.68	2.18	20.08	2.25	<b>19.69</b>	<b>2.28</b>	19.38	2.31	18.63	2.38
		20	19	22.71	2.17	21.99	2.23	21.28	2.31	20.87	2.35	20.54	2.39	19.76	2.45
		25	23	24.85	2.26	24.12	2.33	23.28	2.42	22.84	2.47	22.49	2.50	21.64	2.57
		30	28	27.00	2.37	26.17	2.45	25.27	2.52	24.81	2.58	24.43	2.62	23.54	2.69
		35	32	29.15	2.48	28.22	2.56	27.26	2.63	26.77	2.69	26.38	2.74	25.43	2.81
		40	36	30.64	2.55	29.78	2.64	28.83	2.71	28.33	2.77	27.93	2.81	26.92	2.89
		45	41	32.49	2.64	31.72	2.73	30.78	2.81	30.27	2.86	29.86	2.90	28.78	2.99
		47	43	33.24	2.67	32.49	2.76	31.57	2.85	<b>31.05</b>	<b>2.90</b>	30.64	2.94	29.52	3.03
		50	46	33.33	2.66	32.66	2.74	31.85	2.82	31.39	2.86	31.02	2.89	29.98	2.97
		55	51	33.50	2.63	32.94	2.69	32.33	2.76	31.96	2.79	31.67	2.81	30.73	2.87
		60	56	33.66	2.60	33.22	2.65	32.81	2.70	32.53	2.72	32.31	2.74	31.48	2.78
		63	59	33.76	2.58	33.39	2.63	33.10	2.67	32.87	2.68	32.69	2.69	31.93	2.72
		68	64	33.86	2.57	33.56	2.60	33.39	2.63	33.22	2.64	33.08	2.64	32.39	2.67
	12 + 18	0	-0.4	16.10	2.11	15.14	2.19	15.16	2.23	14.81	2.25	14.53	2.26	13.92	2.34
		5	4.5	19.30	2.19	18.40	2.27	18.13	2.31	17.75	2.34	17.44	2.36	16.73	2.44
		10	9	21.45	2.25	20.58	2.33	20.12	2.39	19.71	2.42	19.39	2.45	18.62	2.53
		17	15	23.81	2.35	22.98	2.42	22.32	2.49	<b>21.88</b>	<b>2.54</b>	21.53	2.57	20.70	2.64
		20	19	25.23	2.41	24.43	2.48	23.64	2.56	23.19	2.61	22.83	2.65	21.96	2.72
		25	23	27.62	2.51	26.80	2.59	25.86	2.68	25.38	2.74	24.98	2.78	24.04	2.85
		30	28	30.00	2.63	29.08	2.72	28.08	2.80	27.56	2.86	27.15	2.91	26.15	2.99
		35	32	32.39	2.75	31.36	2.85	30.29	2.92	29.75	2.99	29.31	3.04	28.25	3.12
		40	36	34.04	2.83	33.08	2.93	32.03	3.01	31.48	3.07	31.03	3.12	29.91	3.21
		45	41	36.10	2.93	35.24	3.03	34.20	3.12	33.64	3.18	33.18	3.22	31.98	3.32
		47	43	36.93	2.97	36.10	3.07	35.07	3.17	<b>34.50</b>	<b>3.22</b>	34.04	3.26	32.80	3.36
		50	46	37.04	2.95	36.29	3.04	35.39	3.13	34.88	3.17	34.47	3.21	33.31	3.30
		55	51	37.22	2.92	36.60	2.99	35.93	3.06	35.51	3.10	35.18	3.12	34.14	3.19
		60	56	37.40	2.89	36.91	2.94	36.46	3.00	36.15	3.02	35.90	3.04	34.98	3.09
		63	59	37.51	2.87	37.10	2.92	36.78	2.96	36.53	2.97	36.33	2.99	35.48	3.02
		68	64	37.62	2.85	37.29	2.89	37.10	2.92	36.91	2.93	36.76	2.94	35.99	2.96
	18 + 18	0	-0.4	17.73	2.32	16.68	2.41	16.69	2.44	16.31	2.46	16.01	2.48	15.33	2.57
		5	4.5	21.26	2.40	20.27	2.48	19.97	2.54	19.55	2.56	19.21	2.59	18.43	2.67
		10	9	23.62	2.47	22.67	2.56	22.17	2.62	21.71	2.66	21.35	2.69	20.51	2.77
		17	15	26.22	2.57	25.31	2.65	24.58	2.74	<b>24.10</b>	<b>2.78</b>	23.71	2.82	22.80	2.90
		20	19	27.79	2.64	26.91	2.72	26.04	2.81	25.54	2.86	25.14	2.90	24.19	2.99
		25	23	30.42	2.75	29.52	2.83	28.49	2.94	27.95	3.00	27.52	3.05	26.48	3.13
		30	28	33.05	2.88	32.03	2.98	30.93	3.07	30.36	3.14	29.90	3.19	28.80	3.27
		35	32	35.68	3.01	34.54	3.12	33.36	3.20	32.77	3.28	32.29	3.34	31.12	3.42
		40	36	37.50	3.10	36.44	3.21	35.28	3.30	34.67	3.37	34.18	3.42	32.94	3.51
		45	41	39.77	3.21	38.82	3.32	37.67	3.42	37.05	3.48	36.55	3.53	35.22	3.64
		47	43	40.68	3.26	39.77	3.36	38.63	3.47	<b>38.00</b>	<b>3.53</b>	37.50	3.58	36.13	3.69
		50	46	40.80	3.23	39.97	3.33	38.98	3.43	38.42	3.48	37.97	3.52	36.68	3.62
		55	51	41.00	3.20	40.32	3.28	39.57	3.36	39.12	3.40	38.75	3.43	37.61	3.50
		60	56	41.19	3.17	40.66	3.23	40.16	3.29	39.81	3.31	39.54	3.33	38.53	3.38
		63	59	41.31	3.15	40.86	3.20	40.51	3.24	40.23	3.26	40.01	3.27	39.08	3.31
		68	64	41.43	3.13	41.07	3.17	40.87	3.20	40.66	3.21	40.49	3.22	39.64	3.24

TC = Total Capacity (kBtu/h).

PI = Power Input (kW).

Nominal capacity as rated: 0 ft. above sea level with 25 ft. of refrigerant piping.  
0 ft. level difference between outdoor and indoor units.

Nominal heating capacity rating obtained with air entering the indoor unit at 70°F dry bulb (DB) and 60°F wet bulb (WB), and outdoor ambient conditions of 47°F dry bulb (DB) and 43°F wet bulb (WB).

# PERFORMANCE DATA

## Heating Capacity Tables

MULTI F  
MULTI F MAX

Table 88: LMU369HV Heating Capacity Table — Non-Ducted Indoor Units.

Connected Indoor Units	Combination Capacity Index	Outdoor Air Temp.		Indoor Air Temp. °F DB											
		°F DB	°F WB	61		64		68		70		72		75	
				TC	PI	TC	PI	TC	PI	TC	PI	TC	PI	TC	PI
Three (3) Non-Ducted Indoor Units	9 + 9 + 9	0	-0.4	14.49	1.90	13.63	1.98	13.64	2.01	13.33	2.02	13.08	2.04	12.52	2.11
		5	4.5	17.37	1.97	16.56	2.04	16.32	2.08	15.97	2.11	15.70	2.12	15.06	2.20
		10	9	19.30	2.03	18.52	2.10	18.11	2.15	17.74	2.18	17.45	2.21	16.76	2.28
		17	15	21.42	2.11	20.68	2.18	20.08	2.25	<b>19.69</b>	<b>2.28</b>	19.38	2.31	18.63	2.38
		20	19	22.71	2.17	21.99	2.23	21.28	2.31	20.87	2.35	20.54	2.39	19.76	2.45
		25	23	24.85	2.26	24.12	2.33	23.28	2.42	22.84	2.47	22.49	2.50	21.64	2.57
		30	28	27.00	2.37	26.17	2.45	25.27	2.52	24.81	2.58	24.43	2.62	23.54	2.69
		35	32	29.15	2.48	28.22	2.56	27.26	2.63	26.77	2.69	26.38	2.74	25.43	2.81
		40	36	30.64	2.55	29.78	2.64	28.83	2.71	28.33	2.77	27.93	2.81	26.92	2.89
		45	41	32.49	2.64	31.72	2.73	30.78	2.81	30.27	2.86	29.86	2.90	28.78	2.99
		47	43	33.24	2.67	32.49	2.76	31.57	2.85	<b>31.05</b>	<b>2.90</b>	30.64	2.94	29.52	3.03
		50	46	33.33	2.66	32.66	2.74	31.85	2.82	31.39	2.86	31.02	2.89	29.98	2.97
		55	51	33.50	2.63	32.94	2.69	32.33	2.76	31.96	2.79	31.67	2.81	30.73	2.87
		60	56	33.66	2.60	33.22	2.65	32.81	2.70	32.53	2.72	32.31	2.74	31.48	2.78
		63	59	33.76	2.58	33.39	2.63	33.10	2.67	32.87	2.68	32.69	2.69	31.93	2.72
		68	64	33.86	2.57	33.56	2.60	33.39	2.63	33.22	2.64	33.08	2.64	32.39	2.67
	9 + 9 + 12	0	-0.4	16.10	2.11	15.14	2.19	15.16	2.23	14.81	2.25	14.53	2.26	13.92	2.34
		5	4.5	19.30	2.19	18.40	2.27	18.13	2.31	17.75	2.34	17.44	2.36	16.73	2.44
		10	9	21.45	2.25	20.58	2.33	20.12	2.39	19.71	2.42	19.39	2.45	18.62	2.53
		17	15	23.81	2.35	22.98	2.42	22.32	2.49	<b>21.88</b>	<b>2.54</b>	21.53	2.57	20.70	2.64
		20	19	25.23	2.41	24.43	2.48	23.64	2.56	23.19	2.61	22.83	2.65	21.96	2.72
		25	23	27.62	2.51	26.80	2.59	25.86	2.68	25.38	2.74	24.98	2.78	24.04	2.85
		30	28	30.00	2.63	29.08	2.72	28.08	2.80	27.56	2.86	27.15	2.91	26.15	2.99
		35	32	32.39	2.75	31.36	2.85	30.29	2.92	29.75	2.99	29.31	3.04	28.25	3.12
		40	36	34.04	2.83	33.08	2.93	32.03	3.01	31.48	3.07	31.03	3.12	29.91	3.21
		45	41	36.10	2.93	35.24	3.03	34.20	3.12	33.64	3.18	33.18	3.22	31.98	3.32
		47	43	36.93	2.97	36.10	3.07	35.07	3.17	<b>34.50</b>	<b>3.22</b>	34.04	3.26	32.80	3.36
		50	46	37.04	2.95	36.29	3.04	35.39	3.13	34.88	3.17	34.47	3.21	33.31	3.30
		55	51	37.22	2.92	36.60	2.99	35.93	3.06	35.51	3.10	35.18	3.12	34.14	3.19
		60	56	37.40	2.89	36.91	2.94	36.46	3.00	36.15	3.02	35.90	3.04	34.98	3.09
		63	59	37.51	2.87	37.10	2.92	36.78	2.96	36.53	2.97	36.33	2.99	35.48	3.02
		68	64	37.62	2.85	37.29	2.89	37.10	2.92	36.91	2.93	36.76	2.94	35.99	2.96
	9 + 12 + 12	0	-0.4	17.71	2.23	16.66	2.32	16.67	2.35	16.29	2.37	15.98	2.39	15.31	2.47
		5	4.5	21.23	2.31	20.24	2.39	19.94	2.44	19.52	2.47	19.18	2.49	18.41	2.57
		10	9	23.59	2.38	22.64	2.46	22.14	2.52	21.69	2.56	21.32	2.59	20.49	2.67
		17	15	26.19	2.48	25.27	2.56	24.55	2.63	<b>24.07</b>	<b>2.68</b>	23.68	2.71	22.77	2.79
		20	19	27.76	2.54	26.87	2.62	26.01	2.71	25.51	2.76	25.11	2.80	24.15	2.88
		25	23	30.38	2.65	29.48	2.73	28.45	2.83	27.91	2.89	27.48	2.94	26.45	3.01
		30	28	33.00	2.78	31.98	2.87	30.88	2.96	30.32	3.02	29.86	3.07	28.77	3.15
		35	32	35.63	2.90	34.50	3.01	33.32	3.08	32.72	3.16	32.24	3.21	31.08	3.29
		40	36	37.45	2.99	36.39	3.09	35.23	3.18	34.62	3.24	34.13	3.30	32.90	3.38
		45	41	39.72	3.09	38.77	3.20	37.62	3.30	37.00	3.36	36.50	3.40	35.17	3.50
		47	43	40.62	3.14	39.72	3.24	38.58	3.34	<b>37.95</b>	<b>3.40</b>	37.45	3.45	36.08	3.55
		50	46	40.74	3.12	39.92	3.21	38.93	3.30	38.37	3.35	37.92	3.39	36.64	3.48
		55	51	40.94	3.08	40.26	3.16	39.52	3.23	39.07	3.27	38.70	3.30	37.56	3.37
		60	56	41.14	3.05	40.60	3.11	40.11	3.17	39.76	3.19	39.49	3.21	38.48	3.26
		63	59	41.26	3.03	40.81	3.08	40.46	3.12	40.18	3.14	39.96	3.15	39.03	3.19
		68	64	41.38	3.01	41.02	3.05	40.81	3.08	40.60	3.09	40.44	3.10	39.59	3.13

TC = Total Capacity (kBtu/h).

PI = Power Input (kW).

Nominal capacity as rated: 0 ft. above sea level with 25 ft. of refrigerant piping.  
0 ft. level difference between outdoor and indoor units.

Nominal heating capacity rating obtained with air entering the indoor unit at 70°F dry bulb (DB) and 60°F wet bulb (WB), and outdoor ambient conditions of 47°F dry bulb (DB) and 43°F wet bulb (WB).



Multi F and Multi F MAX Heat Pump System Engineering Manual

Table 89: LMU369HV Heating Capacity Table — Non-Ducted Indoor Units (continued).

Connected Indoor Units	Combination Capacity Index	Outdoor Air Temp.		Indoor Air Temp. °F DB											
		°F DB	°F WB	61		64		68		70		72		75	
				TC	PI	TC	PI	TC	PI	TC	PI	TC	PI	TC	PI
Three (3) Non-Ducted Indoor Units	12 + 12 + 12	0	-0.4	19.13	2.35	18.00	2.44	18.01	2.48	17.60	2.50	17.27	2.51	16.54	2.60
		5	4.5	22.94	2.43	21.87	2.52	21.55	2.57	21.09	2.60	20.72	2.62	19.89	2.71
		10	9	25.49	2.51	24.46	2.59	23.92	2.66	23.43	2.69	23.04	2.72	22.13	2.81
		17	15	28.29	2.61	27.31	2.69	26.52	2.77	<b>26.00</b>	<b>2.82</b>	25.58	2.86	24.60	2.94
		20	19	29.99	2.67	29.03	2.76	28.10	2.85	27.56	2.90	27.13	2.95	26.10	3.03
		25	23	32.82	2.79	31.85	2.87	30.74	2.98	30.16	3.04	29.69	3.09	28.57	3.17
		30	28	35.66	2.92	34.55	3.02	33.37	3.11	32.75	3.18	32.26	3.24	31.08	3.32
		35	32	38.49	3.06	37.27	3.16	36.00	3.25	35.35	3.32	34.83	3.38	33.58	3.46
		40	36	40.46	3.14	39.32	3.25	38.07	3.35	37.41	3.42	36.88	3.47	35.54	3.56
		45	41	42.91	3.26	41.88	3.37	40.65	3.47	39.97	3.53	39.43	3.58	38.00	3.69
		47	43	43.89	3.30	42.91	3.41	41.68	3.52	<b>41.00</b>	<b>3.58</b>	40.46	3.63	38.98	3.74
		50	46	44.02	3.28	43.13	3.38	42.06	3.48	41.45	3.53	40.96	3.57	39.58	3.67
		55	51	44.23	3.25	43.50	3.33	42.69	3.40	42.20	3.44	41.81	3.47	40.58	3.55
		60	56	44.45	3.21	43.87	3.27	43.33	3.33	42.96	3.36	42.66	3.38	41.57	3.43
		63	59	44.58	3.19	44.09	3.24	43.71	3.29	43.41	3.31	43.17	3.32	42.17	3.36
		68	64	44.70	3.17	44.31	3.21	44.09	3.25	43.87	3.26	43.69	3.26	42.77	3.29
	9 + 9 + 18	0	-0.4	19.13	2.35	18.00	2.44	18.01	2.48	17.60	2.50	17.27	2.51	16.54	2.60
		5	4.5	22.94	2.43	21.87	2.52	21.55	2.57	21.09	2.60	20.72	2.62	19.89	2.71
		10	9	25.49	2.51	24.46	2.59	23.92	2.66	23.43	2.69	23.04	2.72	22.13	2.81
		17	15	28.29	2.61	27.31	2.69	26.52	2.77	<b>26.00</b>	<b>2.82</b>	25.58	2.86	24.60	2.94
		20	19	29.99	2.67	29.03	2.76	28.10	2.85	27.56	2.90	27.13	2.95	26.10	3.03
		25	23	32.82	2.79	31.85	2.87	30.74	2.98	30.16	3.04	29.69	3.09	28.57	3.17
		30	28	35.66	2.92	34.55	3.02	33.37	3.11	32.75	3.18	32.26	3.24	31.08	3.32
		35	32	38.49	3.06	37.27	3.16	36.00	3.25	35.35	3.32	34.83	3.38	33.58	3.46
		40	36	40.46	3.14	39.32	3.25	38.07	3.35	37.41	3.42	36.88	3.47	35.54	3.56
		45	41	42.91	3.26	41.88	3.37	40.65	3.47	39.97	3.53	39.43	3.58	38.00	3.69
		47	43	43.89	3.30	42.91	3.41	41.68	3.52	<b>41.00</b>	<b>3.58</b>	40.46	3.63	38.98	3.74
		50	46	44.02	3.28	43.13	3.38	42.06	3.48	41.45	3.53	40.96	3.57	39.58	3.67
		55	51	44.23	3.25	43.50	3.33	42.69	3.40	42.20	3.44	41.81	3.47	40.58	3.55
		60	56	44.45	3.21	43.87	3.27	43.33	3.33	42.96	3.36	42.66	3.38	41.57	3.43
		63	59	44.58	3.19	44.09	3.24	43.71	3.29	43.41	3.31	43.17	3.32	42.17	3.36
		68	64	44.70	3.17	44.31	3.21	44.09	3.25	43.87	3.26	43.69	3.26	42.77	3.29
	9 + 12 + 18	0	-0.4	19.13	2.35	18.00	2.44	18.01	2.48	17.60	2.50	17.27	2.51	16.54	2.60
		5	4.5	22.94	2.43	21.87	2.52	21.55	2.57	21.09	2.60	20.72	2.62	19.89	2.71
		10	9	25.49	2.51	24.46	2.59	23.92	2.66	23.43	2.69	23.04	2.72	22.13	2.81
		17	15	28.29	2.61	27.31	2.69	26.52	2.77	<b>26.00</b>	<b>2.82</b>	25.58	2.86	24.60	2.94
		20	19	29.99	2.67	29.03	2.76	28.10	2.85	27.56	2.90	27.13	2.95	26.10	3.03
		25	23	32.82	2.79	31.85	2.87	30.74	2.98	30.16	3.04	29.69	3.09	28.57	3.17
		30	28	35.66	2.92	34.55	3.02	33.37	3.11	32.75	3.18	32.26	3.24	31.08	3.32
		35	32	38.49	3.06	37.27	3.16	36.00	3.25	35.35	3.32	34.83	3.38	33.58	3.46
		40	36	40.46	3.14	39.32	3.25	38.07	3.35	37.41	3.42	36.88	3.47	35.54	3.56
		45	41	42.91	3.26	41.88	3.37	40.65	3.47	39.97	3.53	39.43	3.58	38.00	3.69
		47	43	43.89	3.30	42.91	3.41	41.68	3.52	<b>41.00</b>	<b>3.58</b>	40.46	3.63	38.98	3.74
		50	46	44.02	3.28	43.13	3.38	42.06	3.48	41.45	3.53	40.96	3.57	39.58	3.67
		55	51	44.23	3.25	43.50	3.33	42.69	3.40	42.20	3.44	41.81	3.47	40.58	3.55
		60	56	44.45	3.21	43.87	3.27	43.33	3.33	42.96	3.36	42.66	3.38	41.57	3.43
		63	59	44.58	3.19	44.09	3.24	43.71	3.29	43.41	3.31	43.17	3.32	42.17	3.36
		68	64	44.70	3.17	44.31	3.21	44.09	3.25	43.87	3.26	43.69	3.26	42.77	3.29

TC = Total Capacity (kBtu/h).

PI = Power Input (kW).

Nominal capacity as rated: 0 ft. above sea level with 25 ft. of refrigerant piping.  
0 ft. level difference between outdoor and indoor units.

Nominal heating capacity rating obtained with air entering the indoor unit at 70°F dry bulb (DB) and 60°F wet bulb (WB), and outdoor ambient conditions of 47°F dry bulb (DB) and 43°F wet bulb (WB).

# PERFORMANCE DATA

## Heating Capacity Tables

MULTI F  
MULTI F MAX

Table 90: LMU369HV Heating Capacity Table — Non-Ducted Indoor Units (continued).

Connected Indoor Units	Combination Capacity Index	Outdoor Air Temp.		Indoor Air Temp. °F DB											
		°F DB	°F WB	61		64		68		70		72		75	
				TC	PI	TC	PI	TC	PI	TC	PI	TC	PI	TC	PI
Three (3) Non-Ducted Indoor Units	12 + 12 + 18	0	-0.4	19.13	2.35	18.00	2.44	18.01	2.48	17.60	2.50	17.27	2.51	16.54	2.60
		5	4.5	22.94	2.43	21.87	2.52	21.55	2.57	21.09	2.60	20.72	2.62	19.89	2.71
		10	9	25.49	2.51	24.46	2.59	23.92	2.66	23.43	2.69	23.04	2.72	22.13	2.81
		17	15	28.29	2.61	27.31	2.69	26.52	2.77	<b>26.00</b>	<b>2.82</b>	25.58	2.86	24.60	2.94
		20	19	29.99	2.67	29.03	2.76	28.10	2.85	27.56	2.90	27.13	2.95	26.10	3.03
		25	23	32.82	2.79	31.85	2.87	30.74	2.98	30.16	3.04	29.69	3.09	28.57	3.17
		30	28	35.66	2.92	34.55	3.02	33.37	3.11	32.75	3.18	32.26	3.24	31.08	3.32
		35	32	38.49	3.06	37.27	3.16	36.00	3.25	35.35	3.32	34.83	3.38	33.58	3.46
		40	36	40.46	3.14	39.32	3.25	38.07	3.35	37.41	3.42	36.88	3.47	35.54	3.56
		45	41	42.91	3.26	41.88	3.37	40.65	3.47	39.97	3.53	39.43	3.58	38.00	3.69
		47	43	43.89	3.30	42.91	3.41	41.68	3.52	<b>41.00</b>	<b>3.58</b>	40.46	3.63	38.98	3.74
		50	46	44.02	3.28	43.13	3.38	42.06	3.48	41.45	3.53	40.96	3.57	39.58	3.67
		55	51	44.23	3.25	43.50	3.33	42.69	3.40	42.20	3.44	41.81	3.47	40.58	3.55
		60	56	44.45	3.21	43.87	3.27	43.33	3.33	42.96	3.36	42.66	3.38	41.57	3.43
		63	59	44.58	3.19	44.09	3.24	43.71	3.29	43.41	3.31	43.17	3.32	42.17	3.36
		68	64	44.70	3.17	44.31	3.21	44.09	3.25	43.87	3.26	43.69	3.26	42.77	3.29
	9 + 18 + 18	0	-0.4	19.13	2.35	18.00	2.44	18.01	2.48	17.60	2.50	17.27	2.51	16.54	2.60
		5	4.5	22.94	2.43	21.87	2.52	21.55	2.57	21.09	2.60	20.72	2.62	19.89	2.71
		10	9	25.49	2.51	24.46	2.59	23.92	2.66	23.43	2.69	23.04	2.72	22.13	2.81
		17	15	28.29	2.61	27.31	2.69	26.52	2.77	<b>26.00</b>	<b>2.82</b>	25.58	2.86	24.60	2.94
		20	19	29.99	2.67	29.03	2.76	28.10	2.85	27.56	2.90	27.13	2.95	26.10	3.03
		25	23	32.82	2.79	31.85	2.87	30.74	2.98	30.16	3.04	29.69	3.09	28.57	3.17
		30	28	35.66	2.92	34.55	3.02	33.37	3.11	32.75	3.18	32.26	3.24	31.08	3.32
		35	32	38.49	3.06	37.27	3.16	36.00	3.25	35.35	3.32	34.83	3.38	33.58	3.46
		40	36	40.46	3.14	39.32	3.25	38.07	3.35	37.41	3.42	36.88	3.47	35.54	3.56
		45	41	42.91	3.26	41.88	3.37	40.65	3.47	39.97	3.53	39.43	3.58	38.00	3.69
		47	43	43.89	3.30	42.91	3.41	41.68	3.52	<b>41.00</b>	<b>3.58</b>	40.46	3.63	38.98	3.74
		50	46	44.02	3.28	43.13	3.38	42.06	3.48	41.45	3.53	40.96	3.57	39.58	3.67
		55	51	44.23	3.25	43.50	3.33	42.69	3.40	42.20	3.44	41.81	3.47	40.58	3.55
		60	56	44.45	3.21	43.87	3.27	43.33	3.33	42.96	3.36	42.66	3.38	41.57	3.43
		63	59	44.58	3.19	44.09	3.24	43.71	3.29	43.41	3.31	43.17	3.32	42.17	3.36
		68	64	44.70	3.17	44.31	3.21	44.09	3.25	43.87	3.26	43.69	3.26	42.77	3.29
	12 + 18 + 18	0	-0.4	19.13	2.35	18.00	2.44	18.01	2.48	17.60	2.50	17.27	2.51	16.54	2.60
		5	4.5	22.94	2.43	21.87	2.52	21.55	2.57	21.09	2.60	20.72	2.62	19.89	2.71
		10	9	25.49	2.51	24.46	2.59	23.92	2.66	23.43	2.69	23.04	2.72	22.13	2.81
		17	15	28.29	2.61	27.31	2.69	26.52	2.77	<b>26.00</b>	<b>2.82</b>	25.58	2.86	24.60	2.94
		20	19	29.99	2.67	29.03	2.76	28.10	2.85	27.56	2.90	27.13	2.95	26.10	3.03
		25	23	32.82	2.79	31.85	2.87	30.74	2.98	30.16	3.04	29.69	3.09	28.57	3.17
		30	28	35.66	2.92	34.55	3.02	33.37	3.11	32.75	3.18	32.26	3.24	31.08	3.32
		35	32	38.49	3.06	37.27	3.16	36.00	3.25	35.35	3.32	34.83	3.38	33.58	3.46
		40	36	40.46	3.14	39.32	3.25	38.07	3.35	37.41	3.42	36.88	3.47	35.54	3.56
		45	41	42.91	3.26	41.88	3.37	40.65	3.47	39.97	3.53	39.43	3.58	38.00	3.69
		47	43	43.89	3.30	42.91	3.41	41.68	3.52	<b>41.00</b>	<b>3.58</b>	40.46	3.63	38.98	3.74
		50	46	44.02	3.28	43.13	3.38	42.06	3.48	41.45	3.53	40.96	3.57	39.58	3.67
		55	51	44.23	3.25	43.50	3.33	42.69	3.40	42.20	3.44	41.81	3.47	40.58	3.55
		60	56	44.45	3.21	43.87	3.27	43.33	3.33	42.96	3.36	42.66	3.38	41.57	3.43
		63	59	44.58	3.19	44.09	3.24	43.71	3.29	43.41	3.31	43.17	3.32	42.17	3.36
		68	64	44.70	3.17	44.31	3.21	44.09	3.25	43.87	3.26	43.69	3.26	42.77	3.29

TC = Total Capacity (kBtu/h).

PI = Power Input (kW).

Nominal capacity as rated: 0 ft. above sea level with 25 ft. of refrigerant piping.  
0 ft. level difference between outdoor and indoor units.

Nominal heating capacity rating obtained with air entering the indoor unit at 70°F dry bulb (DB) and 60°F wet bulb (WB), and outdoor ambient conditions of 47°F dry bulb (DB) and 43°F wet bulb (WB).



Multi F and Multi F MAX Heat Pump System Engineering Manual

Table 91: LMU369HV Heating Capacity Table — Non-Ducted Indoor Units (continued).

Connected Indoor Units	Combination Capacity Index	Outdoor Air Temp.		Indoor Air Temp. °F DB												
		°F DB	°F WB	61		64		68		70		72		75		
				TC	PI	TC	PI	TC	PI	TC	PI	TC	PI	TC	PI	
Four (4) Non-Ducted Indoor Units	9 + 9 + 9 + 9	0	-0.4	19.13	2.35	18.00	2.44	18.01	2.48	17.60	2.50	17.27	2.51	16.54	2.60	
		5	4.5	22.94	2.43	21.87	2.52	21.55	2.57	21.09	2.60	20.72	2.62	19.89	2.71	
		10	9	25.49	2.51	24.46	2.59	23.92	2.66	23.43	2.69	23.04	2.72	22.13	2.81	
		17	15	28.29	2.61	27.31	2.69	26.52	2.77	<b>26.00</b>	<b>2.82</b>	25.58	2.86	24.60	2.94	
		20	19	29.99	2.67	29.03	2.76	28.10	2.85	27.56	2.90	27.13	2.95	26.10	3.03	
		25	23	32.82	2.79	31.85	2.87	30.74	2.98	30.16	3.04	29.69	3.09	28.57	3.17	
		30	28	35.66	2.92	34.55	3.02	33.37	3.11	32.75	3.18	32.26	3.24	31.08	3.32	
		35	32	38.49	3.06	37.27	3.16	36.00	3.25	35.35	3.32	34.83	3.38	33.58	3.46	
		40	36	40.46	3.14	39.32	3.25	38.07	3.35	37.41	3.42	36.88	3.47	35.54	3.56	
		45	41	42.91	3.26	41.88	3.37	40.65	3.47	39.97	3.53	39.43	3.58	38.00	3.69	
		47	43	43.89	3.30	42.91	3.41	41.68	3.52	<b>41.00</b>	<b>3.58</b>	40.46	3.63	38.98	3.74	
		50	46	44.02	3.28	43.13	3.38	42.06	3.48	41.45	3.53	40.96	3.57	39.58	3.67	
		55	51	44.23	3.25	43.50	3.33	42.69	3.40	42.20	3.44	41.81	3.47	40.58	3.55	
		60	56	44.45	3.21	43.87	3.27	43.33	3.33	42.96	3.36	42.66	3.38	41.57	3.43	
		63	59	44.58	3.19	44.09	3.24	43.71	3.29	43.41	3.31	43.17	3.32	42.17	3.36	
		68	64	44.70	3.17	44.31	3.21	44.09	3.25	43.87	3.26	43.69	3.26	42.77	3.29	
		9 + 9 + 9 + 12	0	-0.4	19.13	2.35	18.00	2.44	18.01	2.48	17.60	2.50	17.27	2.51	16.54	2.60
			5	4.5	22.94	2.43	21.87	2.52	21.55	2.57	21.09	2.60	20.72	2.62	19.89	2.71
	10		9	25.49	2.51	24.46	2.59	23.92	2.66	23.43	2.69	23.04	2.72	22.13	2.81	
	17		15	28.29	2.61	27.31	2.69	26.52	2.77	<b>26.00</b>	<b>2.82</b>	25.58	2.86	24.60	2.94	
	20		19	29.99	2.67	29.03	2.76	28.10	2.85	27.56	2.90	27.13	2.95	26.10	3.03	
	25		23	32.82	2.79	31.85	2.87	30.74	2.98	30.16	3.04	29.69	3.09	28.57	3.17	
	30		28	35.66	2.92	34.55	3.02	33.37	3.11	32.75	3.18	32.26	3.24	31.08	3.32	
	35		32	38.49	3.06	37.27	3.16	36.00	3.25	35.35	3.32	34.83	3.38	33.58	3.46	
	40		36	40.46	3.14	39.32	3.25	38.07	3.35	37.41	3.42	36.88	3.47	35.54	3.56	
	45		41	42.91	3.26	41.88	3.37	40.65	3.47	39.97	3.53	39.43	3.58	38.00	3.69	
	47		43	43.89	3.30	42.91	3.41	41.68	3.52	<b>41.00</b>	<b>3.58</b>	40.46	3.63	38.98	3.74	
	50		46	44.02	3.28	43.13	3.38	42.06	3.48	41.45	3.53	40.96	3.57	39.58	3.67	
	55		51	44.23	3.25	43.50	3.33	42.69	3.40	42.20	3.44	41.81	3.47	40.58	3.55	
	60		56	44.45	3.21	43.87	3.27	43.33	3.33	42.96	3.36	42.66	3.38	41.57	3.43	
	63		59	44.58	3.19	44.09	3.24	43.71	3.29	43.41	3.31	43.17	3.32	42.17	3.36	
	68		64	44.70	3.17	44.31	3.21	44.09	3.25	43.87	3.26	43.69	3.26	42.77	3.29	
	9 + 9 + 12 + 12		0	-0.4	19.13	2.35	18.00	2.44	18.01	2.48	17.60	2.50	17.27	2.51	16.54	2.60
			5	4.5	22.94	2.43	21.87	2.52	21.55	2.57	21.09	2.60	20.72	2.62	19.89	2.71
		10	9	25.49	2.51	24.46	2.59	23.92	2.66	23.43	2.69	23.04	2.72	22.13	2.81	
		17	15	28.29	2.61	27.31	2.69	26.52	2.77	<b>26.00</b>	<b>2.82</b>	25.58	2.86	24.60	2.94	
		20	19	29.99	2.67	29.03	2.76	28.10	2.85	27.56	2.90	27.13	2.95	26.10	3.03	
		25	23	32.82	2.79	31.85	2.87	30.74	2.98	30.16	3.04	29.69	3.09	28.57	3.17	
		30	28	35.66	2.92	34.55	3.02	33.37	3.11	32.75	3.18	32.26	3.24	31.08	3.32	
		35	32	38.49	3.06	37.27	3.16	36.00	3.25	35.35	3.32	34.83	3.38	33.58	3.46	
		40	36	40.46	3.14	39.32	3.25	38.07	3.35	37.41	3.42	36.88	3.47	35.54	3.56	
		45	41	42.91	3.26	41.88	3.37	40.65	3.47	39.97	3.53	39.43	3.58	38.00	3.69	
		47	43	43.89	3.30	42.91	3.41	41.68	3.52	<b>41.00</b>	<b>3.58</b>	40.46	3.63	38.98	3.74	
		50	46	44.02	3.28	43.13	3.38	42.06	3.48	41.45	3.53	40.96	3.57	39.58	3.67	

TC = Total Capacity (kBtu/h).

PI = Power Input (kW).

Nominal capacity as rated: 0 ft. above sea level with 25 ft. of refrigerant piping.  
0 ft. level difference between outdoor and indoor units.

Nominal heating capacity rating obtained with air entering the indoor unit at 70°F dry bulb (DB) and 60°F wet bulb (WB), and outdoor ambient conditions of 47°F dry bulb (DB) and 43°F wet bulb (WB).

# PERFORMANCE DATA

## Heating Capacity Tables

MULTI F  
MULTI F MAX

Table 92: LMU369HV Heating Capacity Table — Non-Ducted Indoor Units (continued).

Connected Indoor Units	Combination Capacity Index	Outdoor Air Temp.		Indoor Air Temp. °F DB											
		°F DB	°F WB	61		64		68		70		72		75	
				TC	PI	TC	PI	TC	PI	TC	PI	TC	PI	TC	PI
Four (4) Non-Ducted Indoor Units	9 + 12 + 12 + 12	0	-0.4	19.13	2.35	18.00	2.44	18.01	2.48	17.60	2.50	17.27	2.51	16.54	2.60
		5	4.5	22.94	2.43	21.87	2.52	21.55	2.57	21.09	2.60	20.72	2.62	19.89	2.71
		10	9	25.49	2.51	24.46	2.59	23.92	2.66	23.43	2.69	23.04	2.72	22.13	2.81
		17	15	28.29	2.61	27.31	2.69	26.52	2.77	<b>26.00</b>	<b>2.82</b>	25.58	2.86	24.60	2.94
		20	19	29.99	2.67	29.03	2.76	28.10	2.85	27.56	2.90	27.13	2.95	26.10	3.03
		25	23	32.82	2.79	31.85	2.87	30.74	2.98	30.16	3.04	29.69	3.09	28.57	3.17
		30	28	35.66	2.92	34.55	3.02	33.37	3.11	32.75	3.18	32.26	3.24	31.08	3.32
		35	32	38.49	3.06	37.27	3.16	36.00	3.25	35.35	3.32	34.83	3.38	33.58	3.46
		40	36	40.46	3.14	39.32	3.25	38.07	3.35	37.41	3.42	36.88	3.47	35.54	3.56
		45	41	42.91	3.26	41.88	3.37	40.65	3.47	39.97	3.53	39.43	3.58	38.00	3.69
		47	43	43.89	3.30	42.91	3.41	41.68	3.52	<b>41.00</b>	<b>3.58</b>	40.46	3.63	38.98	3.74
		50	46	44.02	3.28	43.13	3.38	42.06	3.48	41.45	3.53	40.96	3.57	39.58	3.67
	55	51	44.23	3.25	43.50	3.33	42.69	3.40	42.20	3.44	41.81	3.47	40.58	3.55	
	60	56	44.45	3.21	43.87	3.27	43.33	3.33	42.96	3.36	42.66	3.38	41.57	3.43	
	63	59	44.58	3.19	44.09	3.24	43.71	3.29	43.41	3.31	43.17	3.32	42.17	3.36	
	68	64	44.70	3.17	44.31	3.21	44.09	3.25	43.87	3.26	43.69	3.26	42.77	3.29	
	9 + 9 + 9 + 18	0	-0.4	19.13	2.35	18.00	2.44	18.01	2.48	17.60	2.50	17.27	2.51	16.54	2.60
		5	4.5	22.94	2.43	21.87	2.52	21.55	2.57	21.09	2.60	20.72	2.62	19.89	2.71
		10	9	25.49	2.51	24.46	2.59	23.92	2.66	23.43	2.69	23.04	2.72	22.13	2.81
		17	15	28.29	2.61	27.31	2.69	26.52	2.77	<b>26.00</b>	<b>2.82</b>	25.58	2.86	24.60	2.94
		20	19	29.99	2.67	29.03	2.76	28.10	2.85	27.56	2.90	27.13	2.95	26.10	3.03
		25	23	32.82	2.79	31.85	2.87	30.74	2.98	30.16	3.04	29.69	3.09	28.57	3.17
		30	28	35.66	2.92	34.55	3.02	33.37	3.11	32.75	3.18	32.26	3.24	31.08	3.32
		35	32	38.49	3.06	37.27	3.16	36.00	3.25	35.35	3.32	34.83	3.38	33.58	3.46
		40	36	40.46	3.14	39.32	3.25	38.07	3.35	37.41	3.42	36.88	3.47	35.54	3.56
		45	41	42.91	3.26	41.88	3.37	40.65	3.47	39.97	3.53	39.43	3.58	38.00	3.69
		47	43	43.89	3.30	42.91	3.41	41.68	3.52	<b>41.00</b>	<b>3.58</b>	40.46	3.63	38.98	3.74
		50	46	44.02	3.28	43.13	3.38	42.06	3.48	41.45	3.53	40.96	3.57	39.58	3.67
	55	51	44.23	3.25	43.50	3.33	42.69	3.40	42.20	3.44	41.81	3.47	40.58	3.55	
	60	56	44.45	3.21	43.87	3.27	43.33	3.33	42.96	3.36	42.66	3.38	41.57	3.43	
	63	59	44.58	3.19	44.09	3.24	43.71	3.29	43.41	3.31	43.17	3.32	42.17	3.36	
	68	64	44.70	3.17	44.31	3.21	44.09	3.25	43.87	3.26	43.69	3.26	42.77	3.29	
	9 + 9 + 12 + 18	0	-0.4	19.13	2.35	18.00	2.44	18.01	2.48	17.60	2.50	17.27	2.51	16.54	2.60
		5	4.5	22.94	2.43	21.87	2.52	21.55	2.57	21.09	2.60	20.72	2.62	19.89	2.71
		10	9	25.49	2.51	24.46	2.59	23.92	2.66	23.43	2.69	23.04	2.72	22.13	2.81
		17	15	28.29	2.61	27.31	2.69	26.52	2.77	<b>26.00</b>	<b>2.82</b>	25.58	2.86	24.60	2.94
		20	19	29.99	2.67	29.03	2.76	28.10	2.85	27.56	2.90	27.13	2.95	26.10	3.03
		25	23	32.82	2.79	31.85	2.87	30.74	2.98	30.16	3.04	29.69	3.09	28.57	3.17
		30	28	35.66	2.92	34.55	3.02	33.37	3.11	32.75	3.18	32.26	3.24	31.08	3.32
		35	32	38.49	3.06	37.27	3.16	36.00	3.25	35.35	3.32	34.83	3.38	33.58	3.46
		40	36	40.46	3.14	39.32	3.25	38.07	3.35	37.41	3.42	36.88	3.47	35.54	3.56
		45	41	42.91	3.26	41.88	3.37	40.65	3.47	39.97	3.53	39.43	3.58	38.00	3.69
		47	43	43.89	3.30	42.91	3.41	41.68	3.52	<b>41.00</b>	<b>3.58</b>	40.46	3.63	38.98	3.74
		50	46	44.02	3.28	43.13	3.38	42.06	3.48	41.45	3.53	40.96	3.57	39.58	3.67
	55	51	44.23	3.25	43.50	3.33	42.69	3.40	42.20	3.44	41.81	3.47	40.58	3.55	
	60	56	44.45	3.21	43.87	3.27	43.33	3.33	42.96	3.36	42.66	3.38	41.57	3.43	
	63	59	44.58	3.19	44.09	3.24	43.71	3.29	43.41	3.31	43.17	3.32	42.17	3.36	
	68	64	44.70	3.17	44.31	3.21	44.09	3.25	43.87	3.26	43.69	3.26	42.77	3.29	

TC = Total Capacity (kBtu/h).

PI = Power Input (kW).

Nominal capacity as rated: 0 ft. above sea level with 25 ft. of refrigerant piping.  
0 ft. level difference between outdoor and indoor units.

Nominal heating capacity rating obtained with air entering the indoor unit at 70°F dry bulb (DB) and 60°F wet bulb (WB), and outdoor ambient conditions of 47°F dry bulb (DB) and 43°F wet bulb (WB).



Table 93: LMU369HV Heating Capacity Table — Non-Ducted Indoor Unit (continued) / Ducted Indoor Units.

Connected Indoor Units	Combination Capacity Index	Outdoor Air Temp.		Indoor Air Temp. °F DB											
		°F DB	°F WB	61		64		68		70		72		75	
				TC	PI	TC	PI	TC	PI	TC	PI	TC	PI	TC	PI
Four (4) Non-Ducted Indoor Units	12 + 12 + 12 + 12	0	-0.4	19.13	2.35	18.00	2.44	18.01	2.48	17.60	2.50	17.27	2.51	16.54	2.60
		5	4.5	22.94	2.43	21.87	2.52	21.55	2.57	21.09	2.60	20.72	2.62	19.89	2.71
		10	9	25.49	2.51	24.46	2.59	23.92	2.66	23.43	2.69	23.04	2.72	22.13	2.81
		17	15	28.29	2.61	27.31	2.69	26.52	2.77	<b>26.00</b>	<b>2.82</b>	25.58	2.86	24.60	2.94
		20	19	29.99	2.67	29.03	2.76	28.10	2.85	27.56	2.90	27.13	2.95	26.10	3.03
		25	23	32.82	2.79	31.85	2.87	30.74	2.98	30.16	3.04	29.69	3.09	28.57	3.17
		30	28	35.66	2.92	34.55	3.02	33.37	3.11	32.75	3.18	32.26	3.24	31.08	3.32
		35	32	38.49	3.06	37.27	3.16	36.00	3.25	35.35	3.32	34.83	3.38	33.58	3.46
		40	36	40.46	3.14	39.32	3.25	38.07	3.35	37.41	3.42	36.88	3.47	35.54	3.56
		45	41	42.91	3.26	41.88	3.37	40.65	3.47	39.97	3.53	39.43	3.58	38.00	3.69
		47	43	43.89	3.30	42.91	3.41	41.68	3.52	<b>41.00</b>	<b>3.58</b>	40.46	3.63	38.98	3.74
		50	46	44.02	3.28	43.13	3.38	42.06	3.48	41.45	3.53	40.96	3.57	39.58	3.67
		55	51	44.23	3.25	43.50	3.33	42.69	3.40	42.20	3.44	41.81	3.47	40.58	3.55
		60	56	44.45	3.21	43.87	3.27	43.33	3.33	42.96	3.36	42.66	3.38	41.57	3.43
		63	59	44.58	3.19	44.09	3.24	43.71	3.29	43.41	3.31	43.17	3.32	42.17	3.36
		68	64	44.70	3.17	44.31	3.21	44.09	3.25	43.87	3.26	43.69	3.26	42.77	3.29
Two (2) Ducted Indoor Units	9 + 9	0	-0.4	11.12	1.52	10.48	1.58	10.46	1.61	10.23	1.62	10.04	1.63	9.62	1.69
		5	4.5	12.75	1.56	12.17	1.62	11.98	1.65	11.73	1.67	11.52	1.68	11.06	1.74
		10	9	13.85	1.59	13.29	1.65	12.99	1.69	12.73	1.71	12.52	1.73	12.03	1.79
		17	15	15.05	1.64	14.53	1.69	14.11	1.74	<b>13.83</b>	<b>1.77</b>	13.61	1.80	13.09	1.85
		20	19	15.78	1.67	15.28	1.72	14.79	1.78	14.50	1.81	14.28	1.84	13.73	1.89
		25	23	17.00	1.73	16.49	1.78	15.92	1.84	15.62	1.88	15.38	1.91	14.80	1.96
		30	28	18.22	1.79	17.65	1.85	17.05	1.91	16.73	1.95	16.48	1.98	15.88	2.03
		35	32	19.43	1.85	18.82	1.92	18.17	1.97	17.85	2.01	17.59	2.05	16.95	2.10
		40	36	20.42	1.91	19.85	1.97	19.22	2.03	18.89	2.07	18.62	2.10	17.94	2.16
		45	41	21.66	1.97	21.15	2.04	20.52	2.10	20.18	2.14	19.91	2.17	19.19	2.24
		47	43	22.16	2.00	21.66	2.07	21.04	2.13	<b>20.70</b>	<b>2.17</b>	20.42	2.20	19.68	2.27
		50	46	22.22	1.99	21.77	2.05	21.24	2.11	20.93	2.14	20.68	2.16	19.98	2.22
		55	51	22.33	1.97	21.96	2.02	21.56	2.06	21.31	2.09	21.11	2.11	20.49	2.15
		60	56	22.44	1.95	22.15	1.98	21.88	2.02	21.69	2.04	21.54	2.05	20.99	2.08
		63	59	22.51	1.93	22.26	1.96	22.07	1.99	21.92	2.00	21.80	2.01	21.29	2.04
		68	64	22.57	1.92	22.37	1.95	22.26	1.97	22.15	1.97	22.06	1.98	21.59	1.99
	9 + 12	0	-0.4	12.97	1.80	12.23	1.86	12.21	1.89	11.93	1.91	11.71	1.92	11.22	1.99
		5	4.5	14.88	1.84	14.19	1.91	13.98	1.95	13.68	1.97	13.44	1.99	12.90	2.05
		10	9	16.16	1.88	15.51	1.94	15.16	1.99	14.85	2.02	14.60	2.04	14.03	2.11
		17	15	17.56	1.93	16.95	2.00	16.46	2.06	<b>16.14</b>	<b>2.09</b>	15.88	2.12	15.27	2.18
		20	19	18.41	1.97	17.83	2.03	17.25	2.10	16.92	2.14	16.65	2.17	16.02	2.23
		25	23	19.83	2.04	19.24	2.10	18.57	2.17	18.22	2.22	17.94	2.25	17.26	2.31
		30	28	21.25	2.11	20.59	2.18	19.89	2.25	19.52	2.30	19.23	2.34	18.52	2.40
		35	32	22.67	2.18	21.95	2.26	21.20	2.32	20.82	2.38	20.52	2.42	19.78	2.48
		40	36	23.83	2.25	23.16	2.33	22.42	2.39	22.03	2.44	21.72	2.48	20.94	2.55
		45	41	25.27	2.33	24.67	2.41	23.94	2.48	23.55	2.53	23.23	2.56	22.38	2.64
		47	43	25.85	2.36	25.27	2.44	24.55	2.52	<b>24.15</b>	<b>2.56</b>	23.83	2.59	22.96	2.67
		50	46	25.93	2.35	25.40	2.42	24.78	2.49	24.42	2.52	24.13	2.55	23.31	2.62
		55	51	26.05	2.32	25.62	2.38	25.15	2.43	24.86	2.46	24.63	2.48	23.90	2.54
		60	56	26.18	2.30	25.84	2.34	25.52	2.38	25.30	2.40	25.13	2.42	24.49	2.45
		63	59	26.26	2.28	25.97	2.32	25.75	2.35	25.57	2.36	25.43	2.37	24.84	2.40
		68	64	26.33	2.27	26.10	2.30	25.97	2.32	25.84	2.33	25.73	2.33	25.19	2.35

TC = Total Capacity (kBtu/h).

PI = Power Input (kW).

Nominal capacity as rated: 0 ft. above sea level with 25 ft. of refrigerant piping.  
0 ft. level difference between outdoor and indoor units.

Nominal heating capacity rating obtained with air entering the indoor unit at 70°F dry bulb (DB) and 60°F wet bulb (WB), and outdoor ambient conditions of 47°F dry bulb (DB) and 43°F wet bulb (WB).

# PERFORMANCE DATA

## Heating Capacity Tables

MULTI F  
MULTI F MAX

Table 94: LMU369HV Heating Capacity Table — Ducted Indoor Units.

Connected Indoor Units	Combination Capacity Index	Outdoor Air Temp.		Indoor Air Temp. °F DB											
		°F DB	°F WB	61		64		68		70		72		75	
				TC	PI	TC	PI	TC	PI	TC	PI	TC	PI	TC	PI
Two (2) Ducted Indoor Units	12 + 12	0	-0.4	14.83	1.89	13.98	1.96	13.95	1.99	13.64	2.01	13.38	2.02	12.82	2.09
		5	4.5	17.01	1.93	16.22	2.00	15.97	2.04	15.63	2.07	15.36	2.09	14.75	2.16
		10	9	18.46	1.98	17.72	2.04	17.33	2.10	16.97	2.12	16.69	2.15	16.03	2.21
		17	15	20.07	2.03	19.37	2.10	18.81	2.16	<b>18.44</b>	<b>2.20</b>	18.15	2.23	17.45	2.29
		20	19	21.04	2.07	20.37	2.13	19.72	2.21	19.34	2.25	19.03	2.28	18.31	2.34
		25	23	22.66	2.14	21.99	2.20	21.23	2.28	20.82	2.33	20.50	2.37	19.73	2.43
		30	28	24.29	2.22	23.54	2.29	22.73	2.36	22.31	2.41	21.98	2.46	21.17	2.52
		35	32	25.91	2.30	25.09	2.38	24.23	2.44	23.80	2.50	23.45	2.54	22.60	2.60
		40	36	27.23	2.36	26.47	2.45	25.62	2.51	25.18	2.57	24.83	2.61	23.93	2.68
		45	41	28.88	2.45	28.19	2.53	27.36	2.61	26.91	2.65	26.55	2.69	25.58	2.77
		47	43	29.54	2.48	28.88	2.56	28.06	2.64	<b>27.60</b>	<b>2.69</b>	27.23	2.73	26.24	2.81
		50	46	29.63	2.46	29.03	2.54	28.31	2.61	27.90	2.65	27.58	2.68	26.64	2.76
		55	51	29.78	2.44	29.28	2.50	28.74	2.56	28.41	2.59	28.15	2.61	27.31	2.67
		60	56	29.92	2.41	29.53	2.46	29.17	2.50	28.92	2.52	28.72	2.54	27.98	2.58
		63	59	30.01	2.40	29.68	2.44	29.42	2.47	29.22	2.48	29.06	2.49	28.39	2.52
		68	64	30.09	2.38	29.83	2.41	29.68	2.44	29.53	2.45	29.41	2.45	28.79	2.47
	9 + 18	0	-0.4	16.68	2.12	15.73	2.20	15.69	2.23	15.34	2.25	15.06	2.27	14.42	2.35
		5	4.5	19.13	2.17	18.25	2.25	17.97	2.30	17.59	2.32	17.29	2.34	16.59	2.42
		10	9	20.77	2.22	19.94	2.29	19.49	2.35	19.09	2.38	18.78	2.41	18.04	2.49
		17	15	22.58	2.28	21.79	2.35	21.17	2.43	<b>20.75</b>	<b>2.47</b>	20.42	2.50	19.63	2.57
		20	19	23.67	2.32	22.92	2.40	22.18	2.48	21.75	2.52	21.41	2.56	20.60	2.63
		25	23	25.49	2.40	24.74	2.47	23.88	2.56	23.43	2.62	23.07	2.66	22.20	2.73
		30	28	27.32	2.49	26.48	2.57	25.57	2.65	25.10	2.71	24.72	2.76	23.82	2.83
		35	32	29.15	2.58	28.22	2.67	27.26	2.74	26.77	2.80	26.38	2.85	25.43	2.92
		40	36	30.64	2.65	29.78	2.74	28.83	2.82	28.33	2.88	27.93	2.93	26.92	3.01
		45	41	32.49	2.75	31.72	2.84	30.78	2.93	30.27	2.98	29.86	3.02	28.78	3.11
		47	43	33.24	2.78	32.49	2.88	31.57	2.97	<b>31.05</b>	<b>3.02</b>	30.64	3.06	29.52	3.15
		50	46	33.33	2.77	32.66	2.85	31.85	2.93	31.39	2.98	31.02	3.01	29.98	3.09
		55	51	33.50	2.74	32.94	2.81	32.33	2.87	31.96	2.90	31.67	2.93	30.73	2.99
		60	56	33.66	2.71	33.22	2.76	32.81	2.81	32.53	2.83	32.31	2.85	31.48	2.89
		63	59	33.76	2.69	33.39	2.73	33.10	2.78	32.87	2.79	32.69	2.80	31.93	2.83
		68	64	33.86	2.67	33.56	2.71	33.39	2.74	33.22	2.75	33.08	2.75	32.39	2.78
	12 + 18	0	-0.4	18.53	2.35	17.47	2.44	17.44	2.48	17.05	2.50	16.73	2.52	16.03	2.61
		5	4.5	21.26	2.41	20.28	2.49	19.96	2.55	19.54	2.58	19.21	2.60	18.43	2.69
		10	9	23.08	2.46	22.15	2.54	21.66	2.61	21.22	2.64	20.86	2.67	20.04	2.76
		17	15	25.09	2.53	24.21	2.61	23.52	2.69	<b>23.06</b>	<b>2.74</b>	22.69	2.77	21.81	2.85
		20	19	26.30	2.58	25.46	2.66	24.64	2.75	24.17	2.80	23.79	2.84	22.89	2.92
		25	23	28.33	2.66	27.49	2.74	26.53	2.85	26.03	2.90	25.63	2.95	24.66	3.03
		30	28	30.36	2.76	29.42	2.85	28.41	2.94	27.89	3.01	27.47	3.06	26.46	3.13
		35	32	32.39	2.86	31.36	2.96	30.29	3.04	29.75	3.11	29.31	3.17	28.25	3.24
		40	36	34.04	2.94	33.08	3.04	32.03	3.13	31.48	3.20	31.03	3.25	29.91	3.34
		45	41	36.10	3.05	35.24	3.15	34.20	3.25	33.64	3.31	33.18	3.35	31.98	3.45
		47	43	36.93	3.09	36.10	3.19	35.07	3.29	<b>34.50</b>	<b>3.35</b>	34.04	3.40	32.80	3.50
		50	46	37.04	3.07	36.29	3.16	35.39	3.25	34.88	3.30	34.47	3.34	33.31	3.43
		55	51	37.22	3.04	36.60	3.11	35.93	3.19	35.51	3.22	35.18	3.25	34.14	3.32
		60	56	37.40	3.00	36.91	3.06	36.46	3.12	36.15	3.14	35.90	3.16	34.98	3.21
		63	59	37.51	2.99	37.10	3.03	36.78	3.08	36.53	3.09	36.33	3.11	35.48	3.14
		68	64	37.62	2.97	37.29	3.00	37.10	3.04	36.91	3.05	36.76	3.05	35.99	3.08

TC = Total Capacity (kBtu/h).

PI = Power Input (kW).

Nominal capacity as rated: 0 ft. above sea level with 25 ft. of refrigerant piping.  
0 ft. level difference between outdoor and indoor units.

Nominal heating capacity rating obtained with air entering the indoor unit at 70°F dry bulb (DB) and 60°F wet bulb (WB), and outdoor ambient conditions of 47°F dry bulb (DB) and 43°F wet bulb (WB).



Table 95: LMU369HV Heating Capacity Table — Ducted Indoor Units (continued).

Connected Indoor Units	Combination Capacity Index	Outdoor Air Temp.		Indoor Air Temp. °F DB											
		°F DB	°F WB	61		64		68		70		72		75	
				TC	PI	TC	PI	TC	PI	TC	PI	TC	PI	TC	PI
Two (2) Ducted Indoor Units	18 + 18	0	-0.4	19.34	2.45	18.23	2.54	18.20	2.58	17.79	2.60	17.46	2.62	16.72	2.72
		5	4.5	22.18	2.51	21.16	2.60	20.83	2.65	20.39	2.68	20.04	2.71	19.23	2.80
		10	9	24.08	2.56	23.11	2.65	22.60	2.72	22.14	2.76	21.77	2.79	20.91	2.87
		17	15	26.18	2.64	25.27	2.72	24.54	2.81	<b>24.06</b>	<b>2.85</b>	23.67	2.89	22.76	2.97
		20	19	27.45	2.69	26.57	2.77	25.72	2.86	25.22	2.92	24.83	2.96	23.88	3.04
		25	23	29.56	2.78	28.68	2.86	27.69	2.96	27.16	3.02	26.74	3.07	25.74	3.15
		30	28	31.68	2.88	30.70	2.97	29.65	3.06	29.10	3.13	28.67	3.19	27.61	3.27
		35	32	33.80	2.98	32.72	3.09	31.61	3.16	31.04	3.24	30.59	3.30	29.48	3.38
		40	36	35.52	3.07	34.52	3.17	33.42	3.26	32.84	3.33	32.38	3.38	31.21	3.47
		45	41	37.67	3.17	36.77	3.28	35.69	3.38	35.10	3.44	34.62	3.49	33.37	3.60
		47	43	38.54	3.22	37.67	3.32	36.60	3.43	<b>36.00</b>	<b>3.49</b>	35.52	3.54	34.23	3.64
		50	46	38.65	3.20	37.87	3.29	36.93	3.39	36.40	3.44	35.97	3.48	34.75	3.57
	55	51	38.84	3.16	38.19	3.24	37.49	3.32	37.06	3.36	36.71	3.39	35.63	3.46	
	60	56	39.03	3.13	38.52	3.19	38.04	3.25	37.72	3.27	37.46	3.29	36.50	3.34	
	63	59	39.14	3.11	38.71	3.16	38.38	3.21	38.12	3.22	37.91	3.24	37.02	3.28	
	68	64	39.25	3.09	38.91	3.13	38.71	3.17	38.52	3.17	38.36	3.18	37.56	3.21	
	24 + 9	0	-0.4	20.41	2.58	19.25	2.68	19.21	2.72	18.77	2.75	18.43	2.76	17.65	2.86
		5	4.5	23.41	2.64	22.33	2.74	21.99	2.80	21.53	2.83	21.15	2.85	20.30	2.95
		10	9	25.42	2.70	24.40	2.80	23.85	2.87	23.37	2.91	22.98	2.94	22.08	3.03
		17	15	27.63	2.78	26.67	2.87	25.90	2.96	<b>25.40</b>	<b>3.01</b>	24.99	3.05	24.03	3.14
		20	19	28.97	2.83	28.05	2.92	27.15	3.02	26.62	3.08	26.21	3.12	25.21	3.21
		25	23	31.20	2.93	30.28	3.01	29.22	3.13	28.67	3.19	28.23	3.24	27.17	3.32
		30	28	33.44	3.03	32.41	3.13	31.29	3.23	30.72	3.30	30.26	3.36	29.15	3.44
		35	32	35.68	3.14	34.54	3.25	33.36	3.34	32.77	3.42	32.29	3.48	31.12	3.56
		40	36	37.50	3.23	36.44	3.34	35.28	3.44	34.67	3.51	34.18	3.57	32.94	3.66
		45	41	39.77	3.35	38.82	3.46	37.67	3.57	37.05	3.63	36.55	3.68	35.22	3.79
		47	43	40.68	3.39	39.77	3.51	38.63	3.62	<b>38.00</b>	<b>3.68</b>	37.50	3.73	36.13	3.84
		50	46	40.80	3.37	39.97	3.47	38.98	3.57	38.42	3.63	37.97	3.67	36.68	3.77
	55	51	41.00	3.34	40.32	3.42	39.57	3.50	39.12	3.54	38.75	3.57	37.61	3.65	
	60	56	41.19	3.30	40.66	3.36	40.16	3.43	39.81	3.45	39.54	3.47	38.53	3.53	
	63	59	41.31	3.28	40.86	3.33	40.51	3.38	40.23	3.40	40.01	3.41	39.08	3.45	
	68	64	41.43	3.26	41.07	3.30	40.87	3.34	40.66	3.35	40.49	3.35	39.64	3.38	
	24 + 12	0	-0.4	20.41	2.58	19.25	2.68	19.21	2.72	18.77	2.75	18.43	2.76	17.65	2.86
		5	4.5	23.41	2.64	22.33	2.74	21.99	2.80	21.53	2.83	21.15	2.85	20.30	2.95
		10	9	25.42	2.70	24.40	2.80	23.85	2.87	23.37	2.91	22.98	2.94	22.08	3.03
		17	15	27.63	2.78	26.67	2.87	25.90	2.96	<b>25.40</b>	<b>3.01</b>	24.99	3.05	24.03	3.14
		20	19	28.97	2.83	28.05	2.92	27.15	3.02	26.62	3.08	26.21	3.12	25.21	3.21
		25	23	31.20	2.93	30.28	3.01	29.22	3.13	28.67	3.19	28.23	3.24	27.17	3.32
		30	28	33.44	3.03	32.41	3.13	31.29	3.23	30.72	3.30	30.26	3.36	29.15	3.44
		35	32	35.68	3.14	34.54	3.25	33.36	3.34	32.77	3.42	32.29	3.48	31.12	3.56
		40	36	37.50	3.23	36.44	3.34	35.28	3.44	34.67	3.51	34.18	3.57	32.94	3.66
		45	41	39.77	3.35	38.82	3.46	37.67	3.57	37.05	3.63	36.55	3.68	35.22	3.79
		47	43	40.68	3.39	39.77	3.51	38.63	3.62	<b>38.00</b>	<b>3.68</b>	37.50	3.73	36.13	3.84
		50	46	40.80	3.37	39.97	3.47	38.98	3.57	38.42	3.63	37.97	3.67	36.68	3.77
	55	51	41.00	3.34	40.32	3.42	39.57	3.50	39.12	3.54	38.75	3.57	37.61	3.65	
	60	56	41.19	3.30	40.66	3.36	40.16	3.43	39.81	3.45	39.54	3.47	38.53	3.53	
	63	59	41.31	3.28	40.86	3.33	40.51	3.38	40.23	3.40	40.01	3.41	39.08	3.45	
	68	64	41.43	3.26	41.07	3.30	40.87	3.34	40.66	3.35	40.49	3.35	39.64	3.38	

TC = Total Capacity (kBtu/h).

PI = Power Input (kW).

Nominal capacity as rated: 0 ft. above sea level with 25 ft. of refrigerant piping.  
0 ft. level difference between outdoor and indoor units.

Nominal heating capacity rating obtained with air entering the indoor unit at 70°F dry bulb (DB) and 60°F wet bulb (WB), and outdoor ambient conditions of 47°F dry bulb (DB) and 43°F wet bulb (WB).

# PERFORMANCE DATA

## Heating Capacity Tables

MULTI F  
MULTI F MAX

Table 96: LMU369HV Heating Capacity Table — Ducted Indoor Units (continued).

Connected Indoor Units	Combination Capacity Index	Outdoor Air Temp.		Indoor Air Temp. °F DB											
		°F DB	°F WB	61		64		68		70		72		75	
				TC	PI	TC	PI	TC	PI	TC	PI	TC	PI	TC	PI
Three (3) Ducted Indoor Units	9 + 9 + 9	0	-0.4	16.68	2.12	15.73	2.20	15.69	2.23	15.34	2.25	15.06	2.27	14.42	2.35
		5	4.5	19.13	2.17	18.25	2.25	17.97	2.30	17.59	2.32	17.29	2.34	16.59	2.42
		10	9	20.77	2.22	19.94	2.29	19.49	2.35	19.09	2.38	18.78	2.41	18.04	2.49
		17	15	22.58	2.28	21.79	2.35	21.17	2.43	<b>20.75</b>	<b>2.47</b>	20.42	2.50	19.63	2.57
		20	19	23.67	2.32	22.92	2.40	22.18	2.48	21.75	2.52	21.41	2.56	20.60	2.63
		25	23	25.49	2.40	24.74	2.47	23.88	2.56	23.43	2.62	23.07	2.66	22.20	2.73
		30	28	27.32	2.49	26.48	2.57	25.57	2.65	25.10	2.71	24.72	2.76	23.82	2.83
		35	32	29.15	2.58	28.22	2.67	27.26	2.74	26.77	2.80	26.38	2.85	25.43	2.92
		40	36	30.64	2.65	29.78	2.74	28.83	2.82	28.33	2.88	27.93	2.93	26.92	3.01
		45	41	32.49	2.75	31.72	2.84	30.78	2.93	30.27	2.98	29.86	3.02	28.78	3.11
		47	43	33.24	2.78	32.49	2.88	31.57	2.97	<b>31.05</b>	<b>3.02</b>	30.64	3.06	29.52	3.15
		50	46	33.33	2.77	32.66	2.85	31.85	2.93	31.39	2.98	31.02	3.01	29.98	3.09
	55	51	33.50	2.74	32.94	2.81	32.33	2.87	31.96	2.90	31.67	2.93	30.73	2.99	
	60	56	33.66	2.71	33.22	2.76	32.81	2.81	32.53	2.83	32.31	2.85	31.48	2.89	
	63	59	33.76	2.69	33.39	2.73	33.10	2.78	32.87	2.79	32.69	2.80	31.93	2.83	
	68	64	33.86	2.67	33.56	2.71	33.39	2.74	33.22	2.75	33.08	2.75	32.39	2.78	
	9 + 9 + 12	0	-0.4	18.53	2.35	17.47	2.44	17.44	2.48	17.05	2.50	16.73	2.52	16.03	2.61
		5	4.5	21.26	2.41	20.28	2.49	19.96	2.55	19.54	2.58	19.21	2.60	18.43	2.69
		10	9	23.08	2.46	22.15	2.54	21.66	2.61	21.22	2.64	20.86	2.67	20.04	2.76
		17	15	25.09	2.53	24.21	2.61	23.52	2.69	<b>23.06</b>	<b>2.74</b>	22.69	2.77	21.81	2.85
		20	19	26.30	2.58	25.46	2.66	24.64	2.75	24.17	2.80	23.79	2.84	22.89	2.92
		25	23	28.33	2.66	27.49	2.74	26.53	2.85	26.03	2.90	25.63	2.95	24.66	3.03
		30	28	30.36	2.76	29.42	2.85	28.41	2.94	27.89	3.01	27.47	3.06	26.46	3.13
		35	32	32.39	2.86	31.36	2.96	30.29	3.04	29.75	3.11	29.31	3.17	28.25	3.24
		40	36	34.04	2.94	33.08	3.04	32.03	3.13	31.48	3.20	31.03	3.25	29.91	3.34
		45	41	36.10	3.05	35.24	3.15	34.20	3.25	33.64	3.31	33.18	3.35	31.98	3.45
		47	43	36.93	3.09	36.10	3.19	35.07	3.29	<b>34.50</b>	<b>3.35</b>	34.04	3.40	32.80	3.50
		50	46	37.04	3.07	36.29	3.16	35.39	3.25	34.88	3.30	34.47	3.34	33.31	3.43
	55	51	37.22	3.04	36.60	3.11	35.93	3.19	35.51	3.22	35.18	3.25	34.14	3.32	
	60	56	37.40	3.00	36.91	3.06	36.46	3.12	36.15	3.14	35.90	3.16	34.98	3.21	
	63	59	37.51	2.99	37.10	3.03	36.78	3.08	36.53	3.09	36.33	3.11	35.48	3.14	
	68	64	37.62	2.97	37.29	3.00	37.10	3.04	36.91	3.05	36.76	3.05	35.99	3.08	
	9 + 12 + 12	0	-0.4	20.39	2.49	19.22	2.59	19.18	2.63	18.75	2.65	18.40	2.67	17.63	2.76
		5	4.5	23.38	2.55	22.30	2.64	21.96	2.70	21.50	2.73	21.13	2.75	20.28	2.85
		10	9	25.39	2.61	24.37	2.70	23.82	2.76	23.34	2.80	22.95	2.83	22.05	2.92
		17	15	27.60	2.68	26.64	2.77	25.87	2.85	<b>25.36</b>	<b>2.90</b>	24.96	2.94	24.00	3.02
		20	19	28.93	2.73	28.01	2.82	27.11	2.91	26.59	2.97	26.17	3.01	25.18	3.09
		25	23	31.16	2.82	30.24	2.91	29.19	3.02	28.63	3.08	28.19	3.12	27.13	3.21
		30	28	33.40	2.93	32.36	3.02	31.25	3.12	30.68	3.19	30.22	3.24	29.11	3.32
		35	32	35.63	3.03	34.50	3.14	33.32	3.22	32.72	3.29	32.24	3.35	31.08	3.44
		40	36	37.45	3.12	36.39	3.23	35.23	3.32	34.62	3.39	34.13	3.44	32.90	3.53
		45	41	39.72	3.23	38.77	3.34	37.62	3.44	37.00	3.50	36.50	3.55	35.17	3.66
		47	43	40.62	3.27	39.72	3.38	38.58	3.49	<b>37.95</b>	<b>3.55</b>	37.45	3.60	36.08	3.71
		50	46	40.74	3.25	39.92	3.35	38.93	3.45	38.37	3.50	37.92	3.54	36.64	3.64
	55	51	40.94	3.22	40.26	3.30	39.52	3.38	39.07	3.41	38.70	3.45	37.56	3.52	
	60	56	41.14	3.18	40.60	3.25	40.11	3.31	39.76	3.33	39.49	3.35	38.48	3.40	
	63	59	41.26	3.16	40.81	3.21	40.46	3.26	40.18	3.28	39.96	3.29	39.03	3.33	
	68	64	41.38	3.14	41.02	3.18	40.81	3.22	40.60	3.23	40.44	3.24	39.59	3.26	

TC = Total Capacity (kBtu/h).

PI = Power Input (kW).

Nominal capacity as rated: 0 ft. above sea level with 25 ft. of refrigerant piping.  
0 ft. level difference between outdoor and indoor units.

Nominal heating capacity rating obtained with air entering the indoor unit at 70°F dry bulb (DB) and 60°F wet bulb (WB), and outdoor ambient conditions of 47°F dry bulb (DB) and 43°F wet bulb (WB).

Multi F and Multi F MAX Heat Pump System Engineering Manual

Table 97: LMU369HV Heating Capacity Table — Ducted Indoor Units (continued).

Connected Indoor Units	Combination Capacity Index	Outdoor Air Temp.		Indoor Air Temp. °F DB												
		°F DB	°F WB	61		64		68		70		72		75		
				TC	PI	TC	PI	TC	PI	TC	PI	TC	PI	TC	PI	
Three (3) Ducted Indoor Units	12 + 12 + 12	0	-0.4	22.02	2.61	20.77	2.71	20.72	2.75	20.26	2.78	19.88	2.79	19.05	2.89	
		5	4.5	25.26	2.67	24.10	2.77	23.73	2.83	23.23	2.86	22.82	2.89	21.90	2.98	
		10	9	27.43	2.73	26.32	2.83	25.74	2.90	25.21	2.94	24.79	2.97	23.82	3.06	
		17	15	29.81	2.81	28.78	2.90	27.95	2.99	<b>27.40</b>	<b>3.04</b>	26.96	3.08	25.92	3.17	
		20	19	31.26	2.86	30.26	2.95	29.29	3.05	28.73	3.11	28.28	3.15	27.20	3.24	
		25	23	33.66	2.96	32.67	3.04	31.53	3.16	30.93	3.22	30.46	3.27	29.31	3.36	
		30	28	36.08	3.07	34.96	3.17	33.76	3.27	33.14	3.34	32.65	3.40	31.45	3.48	
		35	32	38.49	3.18	37.27	3.29	36.00	3.37	35.35	3.45	34.83	3.52	33.58	3.60	
		40	36	40.46	3.27	39.32	3.38	38.07	3.48	37.41	3.55	36.88	3.61	35.54	3.70	
		45	41	42.91	3.38	41.88	3.50	40.65	3.61	39.97	3.67	39.43	3.72	38.00	3.83	
		47	43	43.89	3.43	42.91	3.54	41.68	3.66	<b>41.00</b>	<b>3.72</b>	40.46	3.77	38.98	3.88	
		50	46	44.02	3.41	43.13	3.51	42.06	3.61	41.45	3.67	40.96	3.71	39.58	3.81	
		55	51	44.23	3.37	43.50	3.46	42.69	3.54	42.20	3.58	41.81	3.61	40.58	3.69	
		60	56	44.45	3.34	43.87	3.40	43.33	3.46	42.96	3.49	42.66	3.51	41.57	3.56	
		63	59	44.58	3.31	44.09	3.37	43.71	3.42	43.41	3.44	43.17	3.45	42.17	3.49	
		68	64	44.70	3.29	44.31	3.34	44.09	3.37	43.87	3.38	43.69	3.39	42.77	3.42	
		9 + 9 + 18	0	-0.4	22.02	2.61	20.77	2.71	20.72	2.75	20.26	2.78	19.88	2.79	19.05	2.89
			5	4.5	25.26	2.67	24.10	2.77	23.73	2.83	23.23	2.86	22.82	2.89	21.90	2.98
	10		9	27.43	2.73	26.32	2.83	25.74	2.90	25.21	2.94	24.79	2.97	23.82	3.06	
	17		15	29.81	2.81	28.78	2.90	27.95	2.99	<b>27.40</b>	<b>3.04</b>	26.96	3.08	25.92	3.17	
	20		19	31.26	2.86	30.26	2.95	29.29	3.05	28.73	3.11	28.28	3.15	27.20	3.24	
	25		23	33.66	2.96	32.67	3.04	31.53	3.16	30.93	3.22	30.46	3.27	29.31	3.36	
	30		28	36.08	3.07	34.96	3.17	33.76	3.27	33.14	3.34	32.65	3.40	31.45	3.48	
	35		32	38.49	3.18	37.27	3.29	36.00	3.37	35.35	3.45	34.83	3.52	33.58	3.60	
	40		36	40.46	3.27	39.32	3.38	38.07	3.48	37.41	3.55	36.88	3.61	35.54	3.70	
	45		41	42.91	3.38	41.88	3.50	40.65	3.61	39.97	3.67	39.43	3.72	38.00	3.83	
	47		43	43.89	3.43	42.91	3.54	41.68	3.66	<b>41.00</b>	<b>3.72</b>	40.46	3.77	38.98	3.88	
	50		46	44.02	3.41	43.13	3.51	42.06	3.61	41.45	3.67	40.96	3.71	39.58	3.81	
	55		51	44.23	3.37	43.50	3.46	42.69	3.54	42.20	3.58	41.81	3.61	40.58	3.69	
	60		56	44.45	3.34	43.87	3.40	43.33	3.46	42.96	3.49	42.66	3.51	41.57	3.56	
	63		59	44.58	3.31	44.09	3.37	43.71	3.42	43.41	3.44	43.17	3.45	42.17	3.49	
	68		64	44.70	3.29	44.31	3.34	44.09	3.37	43.87	3.38	43.69	3.39	42.77	3.42	
	9 + 12 + 18		0	-0.4	22.02	2.61	20.77	2.71	20.72	2.75	20.26	2.78	19.88	2.79	19.05	2.89
			5	4.5	25.26	2.67	24.10	2.77	23.73	2.83	23.23	2.86	22.82	2.89	21.90	2.98
		10	9	27.43	2.73	26.32	2.83	25.74	2.90	25.21	2.94	24.79	2.97	23.82	3.06	
		17	15	29.81	2.81	28.78	2.90	27.95	2.99	<b>27.40</b>	<b>3.04</b>	26.96	3.08	25.92	3.17	
		20	19	31.26	2.86	30.26	2.95	29.29	3.05	28.73	3.11	28.28	3.15	27.20	3.24	
		25	23	33.66	2.96	32.67	3.04	31.53	3.16	30.93	3.22	30.46	3.27	29.31	3.36	
		30	28	36.08	3.07	34.96	3.17	33.76	3.27	33.14	3.34	32.65	3.40	31.45	3.48	
		35	32	38.49	3.18	37.27	3.29	36.00	3.37	35.35	3.45	34.83	3.52	33.58	3.60	
		40	36	40.46	3.27	39.32	3.38	38.07	3.48	37.41	3.55	36.88	3.61	35.54	3.70	
		45	41	42.91	3.38	41.88	3.50	40.65	3.61	39.97	3.67	39.43	3.72	38.00	3.83	
		47	43	43.89	3.43	42.91	3.54	41.68	3.66	<b>41.00</b>	<b>3.72</b>	40.46	3.77	38.98	3.88	
		50	46	44.02	3.41	43.13	3.51	42.06	3.61	41.45	3.67	40.96	3.71	39.58	3.81	

TC = Total Capacity (kBtu/h).

PI = Power Input (kW).

Nominal capacity as rated: 0 ft. above sea level with 25 ft. of refrigerant piping.  
0 ft. level difference between outdoor and indoor units.

Nominal heating capacity rating obtained with air entering the indoor unit at 70°F dry bulb (DB) and 60°F wet bulb (WB), and outdoor ambient conditions of 47°F dry bulb (DB) and 43°F wet bulb (WB).

# PERFORMANCE DATA

## Heating Capacity Tables

MULTI F  
MULTI F MAX

Table 98: LMU369HV Heating Capacity Table — Ducted Indoor Units (continued).

Connected Indoor Units	Combination Capacity Index	Outdoor Air Temp.		Indoor Air Temp. °F DB											
		°F DB	°F WB	61		64		68		70		72		75	
				TC	PI	TC	PI	TC	PI	TC	PI	TC	PI	TC	PI
Three (3) Ducted Indoor Units	12 + 12 + 18	0	-0.4	22.02	2.61	20.77	2.71	20.72	2.75	20.26	2.78	19.88	2.79	19.05	2.89
		5	4.5	25.26	2.67	24.10	2.77	23.73	2.83	23.23	2.86	22.82	2.89	21.90	2.98
		10	9	27.43	2.73	26.32	2.83	25.74	2.90	25.21	2.94	24.79	2.97	23.82	3.06
		17	15	29.81	2.81	28.78	2.90	27.95	2.99	<b>27.40</b>	<b>3.04</b>	26.96	3.08	25.92	3.17
		20	19	31.26	2.86	30.26	2.95	29.29	3.05	28.73	3.11	28.28	3.15	27.20	3.24
		25	23	33.66	2.96	32.67	3.04	31.53	3.16	30.93	3.22	30.46	3.27	29.31	3.36
		30	28	36.08	3.07	34.96	3.17	33.76	3.27	33.14	3.34	32.65	3.40	31.45	3.48
		35	32	38.49	3.18	37.27	3.29	36.00	3.37	35.35	3.45	34.83	3.52	33.58	3.60
		40	36	40.46	3.27	39.32	3.38	38.07	3.48	37.41	3.55	36.88	3.61	35.54	3.70
		45	41	42.91	3.38	41.88	3.50	40.65	3.61	39.97	3.67	39.43	3.72	38.00	3.83
		47	43	43.89	3.43	42.91	3.54	41.68	3.66	<b>41.00</b>	<b>3.72</b>	40.46	3.77	38.98	3.88
		50	46	44.02	3.41	43.13	3.51	42.06	3.61	41.45	3.67	40.96	3.71	39.58	3.81
		55	51	44.23	3.37	43.50	3.46	42.69	3.54	42.20	3.58	41.81	3.61	40.58	3.69
		60	56	44.45	3.34	43.87	3.40	43.33	3.46	42.96	3.49	42.66	3.51	41.57	3.56
		63	59	44.58	3.31	44.09	3.37	43.71	3.42	43.41	3.44	43.17	3.45	42.17	3.49
		68	64	44.70	3.29	44.31	3.34	44.09	3.37	43.87	3.38	43.69	3.39	42.77	3.42
	9 + 18 + 18	0	-0.4	22.02	2.61	20.77	2.71	20.72	2.75	20.26	2.78	19.88	2.79	19.05	2.89
		5	4.5	25.26	2.67	24.10	2.77	23.73	2.83	23.23	2.86	22.82	2.89	21.90	2.98
		10	9	27.43	2.73	26.32	2.83	25.74	2.90	25.21	2.94	24.79	2.97	23.82	3.06
		17	15	29.81	2.81	28.78	2.90	27.95	2.99	<b>27.40</b>	<b>3.04</b>	26.96	3.08	25.92	3.17
		20	19	31.26	2.86	30.26	2.95	29.29	3.05	28.73	3.11	28.28	3.15	27.20	3.24
		25	23	33.66	2.96	32.67	3.04	31.53	3.16	30.93	3.22	30.46	3.27	29.31	3.36
		30	28	36.08	3.07	34.96	3.17	33.76	3.27	33.14	3.34	32.65	3.40	31.45	3.48
		35	32	38.49	3.18	37.27	3.29	36.00	3.37	35.35	3.45	34.83	3.52	33.58	3.60
		40	36	40.46	3.27	39.32	3.38	38.07	3.48	37.41	3.55	36.88	3.61	35.54	3.70
		45	41	42.91	3.38	41.88	3.50	40.65	3.61	39.97	3.67	39.43	3.72	38.00	3.83
		47	43	43.89	3.43	42.91	3.54	41.68	3.66	<b>41.00</b>	<b>3.72</b>	40.46	3.77	38.98	3.88
		50	46	44.02	3.41	43.13	3.51	42.06	3.61	41.45	3.67	40.96	3.71	39.58	3.81
		55	51	44.23	3.37	43.50	3.46	42.69	3.54	42.20	3.58	41.81	3.61	40.58	3.69
		60	56	44.45	3.34	43.87	3.40	43.33	3.46	42.96	3.49	42.66	3.51	41.57	3.56
		63	59	44.58	3.31	44.09	3.37	43.71	3.42	43.41	3.44	43.17	3.45	42.17	3.49
		68	64	44.70	3.29	44.31	3.34	44.09	3.37	43.87	3.38	43.69	3.39	42.77	3.42
	12 + 18 + 18	0	-0.4	22.02	2.61	20.77	2.71	20.72	2.75	20.26	2.78	19.88	2.79	19.05	2.89
		5	4.5	25.26	2.67	24.10	2.77	23.73	2.83	23.23	2.86	22.82	2.89	21.90	2.98
		10	9	27.43	2.73	26.32	2.83	25.74	2.90	25.21	2.94	24.79	2.97	23.82	3.06
		17	15	29.81	2.81	28.78	2.90	27.95	2.99	<b>27.40</b>	<b>3.04</b>	26.96	3.08	25.92	3.17
		20	19	31.26	2.86	30.26	2.95	29.29	3.05	28.73	3.11	28.28	3.15	27.20	3.24
		25	23	33.66	2.96	32.67	3.04	31.53	3.16	30.93	3.22	30.46	3.27	29.31	3.36
		30	28	36.08	3.07	34.96	3.17	33.76	3.27	33.14	3.34	32.65	3.40	31.45	3.48
		35	32	38.49	3.18	37.27	3.29	36.00	3.37	35.35	3.45	34.83	3.52	33.58	3.60
		40	36	40.46	3.27	39.32	3.38	38.07	3.48	37.41	3.55	36.88	3.61	35.54	3.70
		45	41	42.91	3.38	41.88	3.50	40.65	3.61	39.97	3.67	39.43	3.72	38.00	3.83
		47	43	43.89	3.43	42.91	3.54	41.68	3.66	<b>41.00</b>	<b>3.72</b>	40.46	3.77	38.98	3.88
		50	46	44.02	3.41	43.13	3.51	42.06	3.61	41.45	3.67	40.96	3.71	39.58	3.81
		55	51	44.23	3.37	43.50	3.46	42.69	3.54	42.20	3.58	41.81	3.61	40.58	3.69
		60	56	44.45	3.34	43.87	3.40	43.33	3.46	42.96	3.49	42.66	3.51	41.57	3.56
		63	59	44.58	3.31	44.09	3.37	43.71	3.42	43.41	3.44	43.17	3.45	42.17	3.49
		68	64	44.70	3.29	44.31	3.34	44.09	3.37	43.87	3.38	43.69	3.39	42.77	3.42

TC = Total Capacity (kBtu/h).

PI = Power Input (kW).

Nominal capacity as rated: 0 ft. above sea level with 25 ft. of refrigerant piping.  
0 ft. level difference between outdoor and indoor units.

Nominal heating capacity rating obtained with air entering the indoor unit at 70°F dry bulb (DB) and 60°F wet bulb (WB), and outdoor ambient conditions of 47°F dry bulb (DB) and 43°F wet bulb (WB).



Multi F and Multi F MAX Heat Pump System Engineering Manual

Table 99: LMU369HV Heating Capacity Table — Ducted Indoor Units (continued).

Connected Indoor Units	Combination Capacity Index	Outdoor Air Temp.		Indoor Air Temp. °F DB												
		°F DB	°F WB	61		64		68		70		72		75		
				TC	PI	TC	PI	TC	PI	TC	PI	TC	PI	TC	PI	
Four (4) Ducted Indoor Units	9 + 9 + 9 + 9	0	-0.4	22.02	2.61	20.77	2.71	20.72	2.75	20.26	2.78	19.88	2.79	19.05	2.89	
		5	4.5	25.26	2.67	24.10	2.77	23.73	2.83	23.23	2.86	22.82	2.89	21.90	2.98	
		10	9	27.43	2.73	26.32	2.83	25.74	2.90	25.21	2.94	24.79	2.97	23.82	3.06	
		17	15	29.81	2.81	28.78	2.90	27.95	2.99	27.40	3.04	26.96	3.08	25.92	3.17	
		20	19	31.26	2.86	30.26	2.95	29.29	3.05	28.73	3.11	28.28	3.15	27.20	3.24	
		25	23	33.66	2.96	32.67	3.04	31.53	3.16	30.93	3.22	30.46	3.27	29.31	3.36	
		30	28	36.08	3.07	34.96	3.17	33.76	3.27	33.14	3.34	32.65	3.40	31.45	3.48	
		35	32	38.49	3.18	37.27	3.29	36.00	3.37	35.35	3.45	34.83	3.52	33.58	3.60	
		40	36	40.46	3.27	39.32	3.38	38.07	3.48	37.41	3.55	36.88	3.61	35.54	3.70	
		45	41	42.91	3.38	41.88	3.50	40.65	3.61	39.97	3.67	39.43	3.72	38.00	3.83	
		47	43	43.89	3.43	42.91	3.54	41.68	3.66	41.00	3.72	40.46	3.77	38.98	3.88	
		50	46	44.02	3.41	43.13	3.51	42.06	3.61	41.45	3.67	40.96	3.71	39.58	3.81	
		55	51	44.23	3.37	43.50	3.46	42.69	3.54	42.20	3.58	41.81	3.61	40.58	3.69	
		60	56	44.45	3.34	43.87	3.40	43.33	3.46	42.96	3.49	42.66	3.51	41.57	3.56	
		63	59	44.58	3.31	44.09	3.37	43.71	3.42	43.41	3.44	43.17	3.45	42.17	3.49	
		68	64	44.70	3.29	44.31	3.34	44.09	3.37	43.87	3.38	43.69	3.39	42.77	3.42	
		9 + 9 + 9 + 12	0	-0.4	22.02	2.61	20.77	2.71	20.72	2.75	20.26	2.78	19.88	2.79	19.05	2.89
			5	4.5	25.26	2.67	24.10	2.77	23.73	2.83	23.23	2.86	22.82	2.89	21.90	2.98
	10		9	27.43	2.73	26.32	2.83	25.74	2.90	25.21	2.94	24.79	2.97	23.82	3.06	
	17		15	29.81	2.81	28.78	2.90	27.95	2.99	27.40	3.04	26.96	3.08	25.92	3.17	
	20		19	31.26	2.86	30.26	2.95	29.29	3.05	28.73	3.11	28.28	3.15	27.20	3.24	
	25		23	33.66	2.96	32.67	3.04	31.53	3.16	30.93	3.22	30.46	3.27	29.31	3.36	
	30		28	36.08	3.07	34.96	3.17	33.76	3.27	33.14	3.34	32.65	3.40	31.45	3.48	
	35		32	38.49	3.18	37.27	3.29	36.00	3.37	35.35	3.45	34.83	3.52	33.58	3.60	
	40		36	40.46	3.27	39.32	3.38	38.07	3.48	37.41	3.55	36.88	3.61	35.54	3.70	
	45		41	42.91	3.38	41.88	3.50	40.65	3.61	39.97	3.67	39.43	3.72	38.00	3.83	
	47		43	43.89	3.43	42.91	3.54	41.68	3.66	41.00	3.72	40.46	3.77	38.98	3.88	
	50		46	44.02	3.41	43.13	3.51	42.06	3.61	41.45	3.67	40.96	3.71	39.58	3.81	
	55		51	44.23	3.37	43.50	3.46	42.69	3.54	42.20	3.58	41.81	3.61	40.58	3.69	
	60		56	44.45	3.34	43.87	3.40	43.33	3.46	42.96	3.49	42.66	3.51	41.57	3.56	
	63		59	44.58	3.31	44.09	3.37	43.71	3.42	43.41	3.44	43.17	3.45	42.17	3.49	
	68		64	44.70	3.29	44.31	3.34	44.09	3.37	43.87	3.38	43.69	3.39	42.77	3.42	
	9 + 9 + 12 + 12		0	-0.4	22.02	2.61	20.77	2.71	20.72	2.75	20.26	2.78	19.88	2.79	19.05	2.89
			5	4.5	25.26	2.67	24.10	2.77	23.73	2.83	23.23	2.86	22.82	2.89	21.90	2.98
		10	9	27.43	2.73	26.32	2.83	25.74	2.90	25.21	2.94	24.79	2.97	23.82	3.06	
		17	15	29.81	2.81	28.78	2.90	27.95	2.99	27.40	3.04	26.96	3.08	25.92	3.17	
		20	19	31.26	2.86	30.26	2.95	29.29	3.05	28.73	3.11	28.28	3.15	27.20	3.24	
		25	23	33.66	2.96	32.67	3.04	31.53	3.16	30.93	3.22	30.46	3.27	29.31	3.36	
		30	28	36.08	3.07	34.96	3.17	33.76	3.27	33.14	3.34	32.65	3.40	31.45	3.48	
		35	32	38.49	3.18	37.27	3.29	36.00	3.37	35.35	3.45	34.83	3.52	33.58	3.60	
		40	36	40.46	3.27	39.32	3.38	38.07	3.48	37.41	3.55	36.88	3.61	35.54	3.70	
		45	41	42.91	3.38	41.88	3.50	40.65	3.61	39.97	3.67	39.43	3.72	38.00	3.83	
		47	43	43.89	3.43	42.91	3.54	41.68	3.66	41.00	3.72	40.46	3.77	38.98	3.88	
		50	46	44.02	3.41	43.13	3.51	42.06	3.61	41.45	3.67	40.96	3.71	39.58	3.81	

TC = Total Capacity (kBtu/h).

PI = Power Input (kW).

Nominal capacity as rated: 0 ft. above sea level with 25 ft. of refrigerant piping.  
0 ft. level difference between outdoor and indoor units.

Nominal heating capacity rating obtained with air entering the indoor unit at 70°F dry bulb (DB) and 60°F wet bulb (WB), and outdoor ambient conditions of 47°F dry bulb (DB) and 43°F wet bulb (WB).

# PERFORMANCE DATA

## Heating Capacity Tables

MULTI F  
MULTI F MAX

Table 100: LMU369HV Heating Capacity Table — Ducted Indoor Units (continued).

Connected Indoor Units	Combination Capacity Index	Outdoor Air Temp.		Indoor Air Temp. °F DB												
		°F DB	°F WB	61		64		68		70		72		75		
				TC	PI	TC	PI	TC	PI	TC	PI	TC	PI	TC	PI	
Four (4) Ducted Indoor Units	9 + 12 + 12 + 12	0	-0.4	22.02	2.61	20.77	2.71	20.72	2.75	20.26	2.78	19.88	2.79	19.05	2.89	
		5	4.5	25.26	2.67	24.10	2.77	23.73	2.83	23.23	2.86	22.82	2.89	21.90	2.98	
		10	9	27.43	2.73	26.32	2.83	25.74	2.90	25.21	2.94	24.79	2.97	23.82	3.06	
		17	15	29.81	2.81	28.78	2.90	27.95	2.99	<b>27.40</b>	<b>3.04</b>	26.96	3.08	25.92	3.17	
		20	19	31.26	2.86	30.26	2.95	29.29	3.05	28.73	3.11	28.28	3.15	27.20	3.24	
		25	23	33.66	2.96	32.67	3.04	31.53	3.16	30.93	3.22	30.46	3.27	29.31	3.36	
		30	28	36.08	3.07	34.96	3.17	33.76	3.27	33.14	3.34	32.65	3.40	31.45	3.48	
		35	32	38.49	3.18	37.27	3.29	36.00	3.37	35.35	3.45	34.83	3.52	33.58	3.60	
		40	36	40.46	3.27	39.32	3.38	38.07	3.48	37.41	3.55	36.88	3.61	35.54	3.70	
		45	41	42.91	3.38	41.88	3.50	40.65	3.61	39.97	3.67	39.43	3.72	38.00	3.83	
		47	43	43.89	3.43	42.91	3.54	41.68	3.66	<b>41.00</b>	<b>3.72</b>	40.46	3.77	38.98	3.88	
		50	46	44.02	3.41	43.13	3.51	42.06	3.61	41.45	3.67	40.96	3.71	39.58	3.81	
		55	51	44.23	3.37	43.50	3.46	42.69	3.54	42.20	3.58	41.81	3.61	40.58	3.69	
		60	56	44.45	3.34	43.87	3.40	43.33	3.46	42.96	3.49	42.66	3.51	41.57	3.56	
		63	59	44.58	3.31	44.09	3.37	43.71	3.42	43.41	3.44	43.17	3.45	42.17	3.49	
		68	64	44.70	3.29	44.31	3.34	44.09	3.37	43.87	3.38	43.69	3.39	42.77	3.42	
		9 + 9 + 9 + 18	0	-0.4	22.02	2.61	20.77	2.71	20.72	2.75	20.26	2.78	19.88	2.79	19.05	2.89
			5	4.5	25.26	2.67	24.10	2.77	23.73	2.83	23.23	2.86	22.82	2.89	21.90	2.98
	10		9	27.43	2.73	26.32	2.83	25.74	2.90	25.21	2.94	24.79	2.97	23.82	3.06	
	17		15	29.81	2.81	28.78	2.90	27.95	2.99	<b>27.40</b>	<b>3.04</b>	26.96	3.08	25.92	3.17	
	20		19	31.26	2.86	30.26	2.95	29.29	3.05	28.73	3.11	28.28	3.15	27.20	3.24	
	25		23	33.66	2.96	32.67	3.04	31.53	3.16	30.93	3.22	30.46	3.27	29.31	3.36	
	30		28	36.08	3.07	34.96	3.17	33.76	3.27	33.14	3.34	32.65	3.40	31.45	3.48	
	35		32	38.49	3.18	37.27	3.29	36.00	3.37	35.35	3.45	34.83	3.52	33.58	3.60	
	40		36	40.46	3.27	39.32	3.38	38.07	3.48	37.41	3.55	36.88	3.61	35.54	3.70	
	45		41	42.91	3.38	41.88	3.50	40.65	3.61	39.97	3.67	39.43	3.72	38.00	3.83	
	47		43	43.89	3.43	42.91	3.54	41.68	3.66	<b>41.00</b>	<b>3.72</b>	40.46	3.77	38.98	3.88	
	50		46	44.02	3.41	43.13	3.51	42.06	3.61	41.45	3.67	40.96	3.71	39.58	3.81	
	55		51	44.23	3.37	43.50	3.46	42.69	3.54	42.20	3.58	41.81	3.61	40.58	3.69	
	60		56	44.45	3.34	43.87	3.40	43.33	3.46	42.96	3.49	42.66	3.51	41.57	3.56	
	63		59	44.58	3.31	44.09	3.37	43.71	3.42	43.41	3.44	43.17	3.45	42.17	3.49	
	68		64	44.70	3.29	44.31	3.34	44.09	3.37	43.87	3.38	43.69	3.39	42.77	3.42	
	9 + 9 + 12 + 18		0	-0.4	22.02	2.61	20.77	2.71	20.72	2.75	20.26	2.78	19.88	2.79	19.05	2.89
			5	4.5	25.26	2.67	24.10	2.77	23.73	2.83	23.23	2.86	22.82	2.89	21.90	2.98
		10	9	27.43	2.73	26.32	2.83	25.74	2.90	25.21	2.94	24.79	2.97	23.82	3.06	
		17	15	29.81	2.81	28.78	2.90	27.95	2.99	<b>27.40</b>	<b>3.04</b>	26.96	3.08	25.92	3.17	
		20	19	31.26	2.86	30.26	2.95	29.29	3.05	28.73	3.11	28.28	3.15	27.20	3.24	
		25	23	33.66	2.96	32.67	3.04	31.53	3.16	30.93	3.22	30.46	3.27	29.31	3.36	
		30	28	36.08	3.07	34.96	3.17	33.76	3.27	33.14	3.34	32.65	3.40	31.45	3.48	
		35	32	38.49	3.18	37.27	3.29	36.00	3.37	35.35	3.45	34.83	3.52	33.58	3.60	
		40	36	40.46	3.27	39.32	3.38	38.07	3.48	37.41	3.55	36.88	3.61	35.54	3.70	
		45	41	42.91	3.38	41.88	3.50	40.65	3.61	39.97	3.67	39.43	3.72	38.00	3.83	
		47	43	43.89	3.43	42.91	3.54	41.68	3.66	<b>41.00</b>	<b>3.72</b>	40.46	3.77	38.98	3.88	
		50	46	44.02	3.41	43.13	3.51	42.06	3.61	41.45	3.67	40.96	3.71	39.58	3.81	
		55	51	44.23	3.37	43.50	3.46	42.69	3.54	42.20	3.58	41.81	3.61	40.58	3.69	
		60	56	44.45	3.34	43.87	3.40	43.33	3.46	42.96	3.49	42.66	3.51	41.57	3.56	
		63	59	44.58	3.31	44.09	3.37	43.71	3.42	43.41	3.44	43.17	3.45	42.17	3.49	
		68	64	44.70	3.29	44.31	3.34	44.09	3.37	43.87	3.38	43.69	3.39	42.77	3.42	

TC = Total Capacity (kBtu/h).

PI = Power Input (kW).

Nominal capacity as rated: 0 ft. above sea level with 25 ft. of refrigerant piping.  
0 ft. level difference between outdoor and indoor units.

Nominal heating capacity rating obtained with air entering the indoor unit at 70°F dry bulb (DB) and 60°F wet bulb (WB), and outdoor ambient conditions of 47°F dry bulb (DB) and 43°F wet bulb (WB).



Multi F and Multi F MAX Heat Pump System Engineering Manual

Table 101: LMU369HV Heating Capacity Table — Ducted Indoor Units (continued) / Mixed Indoor Units.

Connected Indoor Units	Combination Capacity Index	Outdoor Air Temp.		Indoor Air Temp. °F DB											
		°F DB	°F WB	61		64		68		70		72		75	
				TC	PI	TC	PI	TC	PI	TC	PI	TC	PI	TC	PI
Four (4) Ducted Indoor Units	12 + 12 + 12 + 12	0	-0.4	22.02	2.61	20.77	2.71	20.72	2.75	20.26	2.78	19.88	2.79	19.05	2.89
		5	4.5	25.26	2.67	24.10	2.77	23.73	2.83	23.23	2.86	22.82	2.89	21.90	2.98
		10	9	27.43	2.73	26.32	2.83	25.74	2.90	25.21	2.94	24.79	2.97	23.82	3.06
		17	15	29.81	2.81	28.78	2.90	27.95	2.99	<b>27.40</b>	<b>3.04</b>	26.96	3.08	25.92	3.17
		20	19	31.26	2.86	30.26	2.95	29.29	3.05	28.73	3.11	28.28	3.15	27.20	3.24
		25	23	33.66	2.96	32.67	3.04	31.53	3.16	30.93	3.22	30.46	3.27	29.31	3.36
		30	28	36.08	3.07	34.96	3.17	33.76	3.27	33.14	3.34	32.65	3.40	31.45	3.48
		35	32	38.49	3.18	37.27	3.29	36.00	3.37	35.35	3.45	34.83	3.52	33.58	3.60
		40	36	40.46	3.27	39.32	3.38	38.07	3.48	37.41	3.55	36.88	3.61	35.54	3.70
		45	41	42.91	3.38	41.88	3.50	40.65	3.61	39.97	3.67	39.43	3.72	38.00	3.83
		47	43	43.89	3.43	42.91	3.54	41.68	3.66	<b>41.00</b>	<b>3.72</b>	40.46	3.77	38.98	3.88
		50	46	44.02	3.41	43.13	3.51	42.06	3.61	41.45	3.67	40.96	3.71	39.58	3.81
		55	51	44.23	3.37	43.50	3.46	42.69	3.54	42.20	3.58	41.81	3.61	40.58	3.69
		60	56	44.45	3.34	43.87	3.40	43.33	3.46	42.96	3.49	42.66	3.51	41.57	3.56
		63	59	44.58	3.31	44.09	3.37	43.71	3.42	43.41	3.44	43.17	3.45	42.17	3.49
		68	64	44.70	3.29	44.31	3.34	44.09	3.37	43.87	3.38	43.69	3.39	42.77	3.42
Two (2) Mixed Indoor Units	9 + 9	0	-0.4	10.39	1.47	9.79	1.53	9.78	1.55	9.56	1.57	9.38	1.58	8.98	1.63
		5	4.5	12.17	1.51	11.60	1.57	11.43	1.60	11.19	1.62	10.99	1.63	10.55	1.69
		10	9	13.36	1.55	12.82	1.60	12.53	1.64	12.28	1.67	12.07	1.68	11.60	1.74
		17	15	14.67	1.60	14.16	1.65	13.75	1.70	<b>13.48</b>	<b>1.73</b>	13.26	1.75	12.75	1.80
		20	19	15.46	1.63	14.97	1.68	14.49	1.74	14.21	1.77	13.99	1.79	13.45	1.84
		25	23	16.78	1.69	16.29	1.74	15.72	1.80	15.42	1.84	15.18	1.87	14.61	1.92
		30	28	18.11	1.75	17.55	1.81	16.95	1.87	16.63	1.91	16.39	1.94	15.78	1.99
		35	32	19.43	1.82	18.82	1.88	18.17	1.93	17.85	1.98	17.59	2.01	16.95	2.06
		40	36	20.42	1.87	19.85	1.94	19.22	1.99	18.89	2.03	18.62	2.07	17.94	2.12
		45	41	21.66	1.94	21.15	2.00	20.52	2.06	20.18	2.10	19.91	2.13	19.19	2.19
		47	43	22.16	1.96	21.66	2.03	21.04	2.09	<b>20.70</b>	<b>2.13</b>	20.42	2.16	19.68	2.22
		50	46	22.22	1.95	21.77	2.01	21.24	2.07	20.93	2.10	20.68	2.12	19.98	2.18
		55	51	22.33	1.93	21.96	1.98	21.56	2.03	21.31	2.05	21.11	2.07	20.49	2.11
		60	56	22.44	1.91	22.15	1.95	21.88	1.98	21.69	2.00	21.54	2.01	20.99	2.04
		63	59	22.51	1.90	22.26	1.93	22.07	1.96	21.92	1.97	21.80	1.98	21.29	2.00
		68	64	22.57	1.89	22.37	1.91	22.26	1.93	22.15	1.94	22.06	1.94	21.59	1.96
	9 + 12	0	-0.4	12.12	1.76	11.42	1.83	11.41	1.86	11.15	1.88	10.94	1.89	10.48	1.96
		5	4.5	14.20	1.81	13.54	1.88	13.33	1.92	13.05	1.94	12.83	1.95	12.31	2.02
		10	9	15.58	1.85	14.96	1.92	14.62	1.97	14.33	1.99	14.09	2.01	13.53	2.08
		17	15	17.11	1.91	16.52	1.97	16.04	2.03	<b>15.73</b>	<b>2.07</b>	15.48	2.10	14.88	2.16
		20	19	18.04	1.95	17.46	2.01	16.90	2.08	16.58	2.12	16.32	2.15	15.70	2.21
		25	23	19.58	2.02	19.00	2.08	18.34	2.16	17.99	2.20	17.71	2.24	17.05	2.29
		30	28	21.13	2.10	20.47	2.17	19.77	2.23	19.41	2.28	19.12	2.32	18.41	2.38
		35	32	22.67	2.18	21.95	2.25	21.20	2.31	20.82	2.37	20.52	2.41	19.78	2.47
		40	36	23.83	2.24	23.16	2.32	22.42	2.38	22.03	2.43	21.72	2.47	20.94	2.54
		45	41	25.27	2.32	24.67	2.40	23.94	2.47	23.55	2.52	23.23	2.55	22.38	2.63
		47	43	25.85	2.35	25.27	2.43	24.55	2.51	<b>24.15</b>	<b>2.55</b>	23.83	2.58	22.96	2.66
		50	46	25.93	2.34	25.40	2.41	24.78	2.48	24.42	2.51	24.13	2.54	23.31	2.61
		55	51	26.05	2.31	25.62	2.37	25.15	2.43	24.86	2.45	24.63	2.47	23.90	2.53
		60	56	26.18	2.29	25.84	2.33	25.52	2.37	25.30	2.39	25.13	2.41	24.49	2.44
		63	59	26.26	2.27	25.97	2.31	25.75	2.34	25.57	2.36	25.43	2.36	24.84	2.39
		68	64	26.33	2.26	26.10	2.29	25.97	2.31	25.84	2.32	25.73	2.32	25.19	2.34

TC = Total Capacity (kBtu/h).

PI = Power Input (kW).

Nominal capacity as rated: 0 ft. above sea level with 25 ft. of refrigerant piping.  
0 ft. level difference between outdoor and indoor units.

Nominal heating capacity rating obtained with air entering the indoor unit at 70°F dry bulb (DB) and 60°F wet bulb (WB), and outdoor ambient conditions of 47°F dry bulb (DB) and 43°F wet bulb (WB).

# PERFORMANCE DATA

## Heating Capacity Tables

MULTI F  
MULTI F MAX

Table 102: LMU369HV Heating Capacity Table — Mixed Indoor Units (continued).

Connected Indoor Units	Combination Capacity Index	Outdoor Air Temp.		Indoor Air Temp. °F DB											
		°F DB	°F WB	61		64		68		70		72		75	
				TC	PI	TC	PI	TC	PI	TC	PI	TC	PI	TC	PI
Two (2) Mixed Indoor Units	12 + 12	0	-0.4	13.85	1.83	13.05	1.90	13.04	1.93	12.74	1.94	12.50	1.96	11.98	2.03
		5	4.5	16.22	1.88	15.47	1.94	15.24	1.98	14.92	2.01	14.66	2.02	14.07	2.09
		10	9	17.81	1.92	17.09	1.99	16.71	2.04	16.37	2.06	16.10	2.09	15.47	2.15
		17	15	19.56	1.98	18.88	2.04	18.33	2.11	<b>17.97</b>	<b>2.14</b>	17.69	2.17	17.01	2.23
		20	19	20.61	2.02	19.96	2.08	19.32	2.15	18.94	2.19	18.65	2.22	17.94	2.29
		25	23	22.38	2.09	21.71	2.15	20.96	2.23	20.56	2.28	20.24	2.31	19.48	2.38
		30	28	24.15	2.17	23.40	2.24	22.59	2.31	22.18	2.36	21.85	2.40	21.05	2.47
		35	32	25.91	2.25	25.09	2.33	24.23	2.39	23.80	2.45	23.45	2.49	22.60	2.56
		40	36	27.23	2.32	26.47	2.40	25.62	2.47	25.18	2.52	24.83	2.56	23.93	2.63
		45	41	28.88	2.40	28.19	2.48	27.36	2.56	26.91	2.61	26.55	2.64	25.58	2.72
		47	43	29.54	2.43	28.88	2.51	28.06	2.60	<b>27.60</b>	<b>2.64</b>	27.23	2.68	26.24	2.76
		50	46	29.63	2.42	29.03	2.49	28.31	2.56	27.90	2.60	27.58	2.63	26.64	2.70
	55	51	29.78	2.39	29.28	2.45	28.74	2.51	28.41	2.54	28.15	2.56	27.31	2.62	
	60	56	29.92	2.37	29.53	2.41	29.17	2.46	28.92	2.48	28.72	2.49	27.98	2.53	
	63	59	30.01	2.35	29.68	2.39	29.42	2.43	29.22	2.44	29.06	2.45	28.39	2.48	
	68	64	30.09	2.34	29.83	2.37	29.68	2.39	29.53	2.40	29.41	2.41	28.79	2.43	
	0	-0.4	15.58	2.05	14.68	2.13	14.67	2.16	14.33	2.18	14.07	2.19	13.47	2.27	
	5	4.5	18.25	2.10	17.40	2.18	17.14	2.22	16.78	2.25	16.49	2.27	15.83	2.34	
	10	9	20.04	2.15	19.23	2.23	18.80	2.28	18.42	2.31	18.11	2.34	17.40	2.41	
	17	15	22.00	2.22	21.24	2.29	20.62	2.36	<b>20.22</b>	<b>2.40</b>	19.90	2.43	19.13	2.50	
	20	19	23.19	2.26	22.45	2.33	21.73	2.41	21.31	2.46	20.98	2.49	20.18	2.56	
	25	23	25.17	2.34	24.43	2.41	23.58	2.50	23.13	2.55	22.78	2.59	21.92	2.66	
	30	28	27.16	2.44	26.32	2.52	25.42	2.59	24.95	2.65	24.58	2.70	23.68	2.76	
	35	32	29.15	2.53	28.22	2.62	27.26	2.68	26.77	2.75	26.38	2.80	25.43	2.86	
	40	36	30.64	2.60	29.78	2.69	28.83	2.77	28.33	2.82	27.93	2.87	26.92	2.95	
	45	41	32.49	2.69	31.72	2.78	30.78	2.87	30.27	2.92	29.86	2.96	28.78	3.05	
	47	43	33.24	2.73	32.49	2.82	31.57	2.91	<b>31.05</b>	<b>2.96</b>	30.64	3.00	29.52	3.09	
	50	46	33.33	2.71	32.66	2.79	31.85	2.87	31.39	2.92	31.02	2.95	29.98	3.03	
	55	51	33.50	2.68	32.94	2.75	32.33	2.82	31.96	2.85	31.67	2.87	30.73	2.93	
	60	56	33.66	2.65	33.22	2.71	32.81	2.76	32.53	2.78	32.31	2.79	31.48	2.84	
	63	59	33.76	2.64	33.39	2.68	33.10	2.72	32.87	2.73	32.69	2.75	31.93	2.78	
	68	64	33.86	2.62	33.56	2.65	33.39	2.69	33.22	2.69	33.08	2.70	32.39	2.72	
	0	-0.4	17.32	2.28	16.31	2.36	16.30	2.40	15.93	2.42	15.63	2.44	14.97	2.52	
	5	4.5	20.28	2.34	19.34	2.42	19.05	2.47	18.64	2.50	18.32	2.52	17.58	2.61	
	10	9	22.26	2.39	21.37	2.47	20.89	2.54	20.47	2.57	20.12	2.60	19.33	2.68	
	17	15	24.45	2.47	23.60	2.55	22.92	2.62	<b>22.47</b>	<b>2.67</b>	22.11	2.70	21.26	2.78	
	20	19	25.77	2.52	24.95	2.59	24.14	2.68	23.68	2.73	23.31	2.77	22.42	2.85	
	25	23	27.97	2.61	27.14	2.68	26.20	2.78	25.70	2.84	25.31	2.88	24.35	2.96	
	30	28	30.18	2.71	29.25	2.80	28.24	2.88	27.72	2.95	27.31	3.00	26.31	3.07	
	35	32	32.39	2.81	31.36	2.91	30.29	2.98	29.75	3.05	29.31	3.11	28.25	3.18	
	40	36	34.04	2.89	33.08	2.99	32.03	3.07	31.48	3.14	31.03	3.19	29.91	3.28	
	45	41	36.10	2.99	35.24	3.09	34.20	3.19	33.64	3.25	33.18	3.29	31.98	3.39	
	47	43	36.93	3.03	36.10	3.13	35.07	3.23	<b>34.50</b>	<b>3.29</b>	34.04	3.33	32.80	3.43	
	50	46	37.04	3.01	36.29	3.10	35.39	3.19	34.88	3.24	34.47	3.28	33.31	3.37	
	55	51	37.22	2.98	36.60	3.06	35.93	3.13	35.51	3.16	35.18	3.19	34.14	3.26	
	60	56	37.40	2.95	36.91	3.01	36.46	3.06	36.15	3.09	35.90	3.10	34.98	3.15	
	63	59	37.51	2.93	37.10	2.98	36.78	3.02	36.53	3.04	36.33	3.05	35.48	3.09	
	68	64	37.62	2.91	37.29	2.95	37.10	2.98	36.91	2.99	36.76	3.00	35.99	3.02	

TC = Total Capacity (kBtu/h).

PI = Power Input (kW).

Nominal capacity as rated: 0 ft. above sea level with 25 ft. of refrigerant piping.  
0 ft. level difference between outdoor and indoor units.

Nominal heating capacity rating obtained with air entering the indoor unit at 70°F dry bulb (DB) and 60°F wet bulb (WB), and outdoor ambient conditions of 47°F dry bulb (DB) and 43°F wet bulb (WB).



Multi F and Multi F MAX Heat Pump System Engineering Manual

Table 103: LMU369HV Heating Capacity Table — Mixed Indoor Units (continued).

Connected Indoor Units	Combination Capacity Index	Outdoor Air Temp.		Indoor Air Temp. °F DB												
		°F DB	°F WB	61		64		68		70		72		75		
				TC	PI	TC	PI	TC	PI	TC	PI	TC	PI	TC	PI	
Two (2) Mixed Indoor Units	18 + 18	0	-0.4	18.07	2.37	17.02	2.46	17.01	2.50	16.62	2.52	16.31	2.54	15.62	2.63	
		5	4.5	21.16	2.44	20.18	2.52	19.88	2.58	19.46	2.61	19.12	2.63	18.35	2.72	
		10	9	23.23	2.49	22.29	2.58	21.80	2.65	21.35	2.68	21.00	2.71	20.17	2.80	
		17	15	25.51	2.57	24.62	2.65	23.91	2.74	<b>23.44</b>	<b>2.78</b>	23.07	2.82	22.18	2.90	
		20	19	26.89	2.62	26.03	2.70	25.19	2.80	24.71	2.85	24.32	2.89	23.40	2.97	
		25	23	29.19	2.72	28.32	2.80	27.34	2.90	26.82	2.96	26.41	3.01	25.41	3.09	
		30	28	31.49	2.82	30.52	2.92	29.47	3.01	28.93	3.07	28.50	3.12	27.45	3.20	
		35	32	33.80	2.93	32.72	3.03	31.61	3.11	31.04	3.18	30.59	3.24	29.48	3.32	
		40	36	35.52	3.01	34.52	3.12	33.42	3.21	32.84	3.27	32.38	3.33	31.21	3.41	
		45	41	37.67	3.12	36.77	3.22	35.69	3.32	35.10	3.39	34.62	3.43	33.37	3.53	
		47	43	38.54	3.16	37.67	3.27	36.60	3.37	<b>36.00</b>	<b>3.43</b>	35.52	3.48	34.23	3.58	
		50	46	38.65	3.14	37.87	3.24	36.93	3.33	36.40	3.38	35.97	3.42	34.75	3.51	
		55	51	38.84	3.11	38.19	3.19	37.49	3.26	37.06	3.30	36.71	3.33	35.63	3.40	
		60	56	39.03	3.08	38.52	3.14	38.04	3.19	37.72	3.22	37.46	3.24	36.50	3.29	
		63	59	39.14	3.06	38.71	3.11	38.38	3.15	38.12	3.17	37.91	3.18	37.02	3.22	
		68	64	39.25	3.04	38.91	3.08	38.71	3.11	38.52	3.12	38.36	3.13	37.56	3.15	
		24 + 9	0	-0.4	19.07	2.50	17.96	2.59	17.95	2.63	17.54	2.66	17.22	2.67	16.49	2.77
			5	4.5	22.34	2.56	21.30	2.66	20.98	2.71	20.54	2.74	20.18	2.77	19.37	2.86
	10		9	24.52	2.63	23.53	2.72	23.01	2.78	22.54	2.82	22.17	2.85	21.29	2.94	
	17		15	26.93	2.71	25.99	2.79	25.24	2.88	<b>24.75</b>	<b>2.93</b>	24.35	2.97	23.41	3.05	
	20		19	28.38	2.76	27.48	2.85	26.59	2.94	26.08	3.00	25.67	3.04	24.70	3.13	
	25		23	30.81	2.86	29.90	2.94	28.86	3.05	28.31	3.12	27.87	3.16	26.82	3.25	
	30		28	33.24	2.97	32.22	3.07	31.11	3.16	30.54	3.23	30.08	3.29	28.98	3.37	
	35		32	35.68	3.08	34.54	3.19	33.36	3.27	32.77	3.35	32.29	3.41	31.12	3.49	
	40		36	37.50	3.17	36.44	3.28	35.28	3.37	34.67	3.44	34.18	3.50	32.94	3.59	
	45		41	39.77	3.28	38.82	3.39	37.67	3.50	37.05	3.56	36.55	3.61	35.22	3.72	
	47		43	40.68	3.33	39.77	3.44	38.63	3.55	<b>38.00</b>	<b>3.61</b>	37.50	3.66	36.13	3.77	
	50		46	40.80	3.31	39.97	3.41	38.98	3.51	38.42	3.56	37.97	3.60	36.68	3.70	
	55		51	41.00	3.27	40.32	3.35	39.57	3.43	39.12	3.47	38.75	3.50	37.61	3.58	
	60		56	41.19	3.24	40.66	3.30	40.16	3.36	39.81	3.39	39.54	3.41	38.53	3.46	
	63		59	41.31	3.22	40.86	3.27	40.51	3.32	40.23	3.33	40.01	3.35	39.08	3.39	
	68		64	41.43	3.20	41.07	3.24	40.87	3.27	40.66	3.28	40.49	3.29	39.64	3.32	
	24 + 12		0	-0.4	19.07	2.50	17.96	2.59	17.95	2.63	17.54	2.66	17.22	2.67	16.49	2.77
			5	4.5	22.34	2.56	21.30	2.66	20.98	2.71	20.54	2.74	20.18	2.77	19.37	2.86
		10	9	24.52	2.63	23.53	2.72	23.01	2.78	22.54	2.82	22.17	2.85	21.29	2.94	
		17	15	26.93	2.71	25.99	2.79	25.24	2.88	<b>24.75</b>	<b>2.93</b>	24.35	2.97	23.41	3.05	
		20	19	28.38	2.76	27.48	2.85	26.59	2.94	26.08	3.00	25.67	3.04	24.70	3.13	
		25	23	30.81	2.86	29.90	2.94	28.86	3.05	28.31	3.12	27.87	3.16	26.82	3.25	
		30	28	33.24	2.97	32.22	3.07	31.11	3.16	30.54	3.23	30.08	3.29	28.98	3.37	
		35	32	35.68	3.08	34.54	3.19	33.36	3.27	32.77	3.35	32.29	3.41	31.12	3.49	
		40	36	37.50	3.17	36.44	3.28	35.28	3.37	34.67	3.44	34.18	3.50	32.94	3.59	
		45	41	39.77	3.28	38.82	3.39	37.67	3.50	37.05	3.56	36.55	3.61	35.22	3.72	
		47	43	40.68	3.33	39.77	3.44	38.63	3.55	<b>38.00</b>	<b>3.61</b>	37.50	3.66	36.13	3.77	
		50	46	40.80	3.31	39.97	3.41	38.98	3.51	38.42	3.56	37.97	3.60	36.68	3.70	
		55	51	41.00	3.27	40.32	3.35	39.57	3.43	39.12	3.47	38.75	3.50	37.61	3.58	
		60	56	41.19	3.24	40.66	3.30	40.16	3.36	39.81	3.39	39.54	3.41	38.53	3.46	
		63	59	41.31	3.22	40.86	3.27	40.51	3.32	40.23	3.33	40.01	3.35	39.08	3.39	
		68	64	41.43	3.20	41.07	3.24	40.87	3.27	40.66	3.28	40.49	3.29	39.64	3.32	

TC = Total Capacity (kBtu/h).

PI = Power Input (kW).

Nominal capacity as rated: 0 ft. above sea level with 25 ft. of refrigerant piping.  
0 ft. level difference between outdoor and indoor units.

Nominal heating capacity rating obtained with air entering the indoor unit at 70°F dry bulb (DB) and 60°F wet bulb (WB), and outdoor ambient conditions of 47°F dry bulb (DB) and 43°F wet bulb (WB).

# PERFORMANCE DATA

## Heating Capacity Tables

MULTI F  
MULTI F MAX

Table 104: LMU369HV Heating Capacity Table — Mixed Indoor Units (continued).

Connected Indoor Units	Combination Capacity Index	Outdoor Air Temp.		Indoor Air Temp. °F DB											
		°F DB	°F WB	61		64		68		70		72		75	
				TC	PI	TC	PI	TC	PI	TC	PI	TC	PI	TC	PI
Three (3) Mixed Indoor Units	9 + 9 + 9	0	-0.4	15.58	2.05	14.68	2.13	14.67	2.16	14.33	2.18	14.07	2.19	13.47	2.27
		5	4.5	18.25	2.10	17.40	2.18	17.14	2.22	16.78	2.25	16.49	2.27	15.83	2.34
		10	9	20.04	2.15	19.23	2.23	18.80	2.28	18.42	2.31	18.11	2.34	17.40	2.41
		17	15	22.00	2.22	21.24	2.29	20.62	2.36	<b>20.22</b>	<b>2.40</b>	19.90	2.43	19.13	2.50
		20	19	23.19	2.26	22.45	2.33	21.73	2.41	21.31	2.46	20.98	2.49	20.18	2.56
		25	23	25.17	2.34	24.43	2.41	23.58	2.50	23.13	2.55	22.78	2.59	21.92	2.66
		30	28	27.16	2.44	26.32	2.52	25.42	2.59	24.95	2.65	24.58	2.70	23.68	2.76
		35	32	29.15	2.53	28.22	2.62	27.26	2.68	26.77	2.75	26.38	2.80	25.43	2.86
		40	36	30.64	2.60	29.78	2.69	28.83	2.77	28.33	2.82	27.93	2.87	26.92	2.95
		45	41	32.49	2.69	31.72	2.78	30.78	2.87	30.27	2.92	29.86	2.96	28.78	3.05
		47	43	33.24	2.73	32.49	2.82	31.57	2.91	<b>31.05</b>	<b>2.96</b>	30.64	3.00	29.52	3.09
		50	46	33.33	2.71	32.66	2.79	31.85	2.87	31.39	2.92	31.02	2.95	29.98	3.03
	55	51	33.50	2.68	32.94	2.75	32.33	2.82	31.96	2.85	31.67	2.87	30.73	2.93	
	60	56	33.66	2.65	33.22	2.71	32.81	2.76	32.53	2.78	32.31	2.79	31.48	2.84	
	63	59	33.76	2.64	33.39	2.68	33.10	2.72	32.87	2.73	32.69	2.75	31.93	2.78	
	68	64	33.86	2.62	33.56	2.65	33.39	2.69	33.22	2.69	33.08	2.70	32.39	2.72	
	9 + 9 + 12	0	-0.4	17.32	2.28	16.31	2.36	16.30	2.40	15.93	2.42	15.63	2.44	14.97	2.52
		5	4.5	20.28	2.34	19.34	2.42	19.05	2.47	18.64	2.50	18.32	2.52	17.58	2.61
		10	9	22.26	2.39	21.37	2.47	20.89	2.54	20.47	2.57	20.12	2.60	19.33	2.68
		17	15	24.45	2.47	23.60	2.55	22.92	2.62	<b>22.47</b>	<b>2.67</b>	22.11	2.70	21.26	2.78
		20	19	25.77	2.52	24.95	2.59	24.14	2.68	23.68	2.73	23.31	2.77	22.42	2.85
		25	23	27.97	2.61	27.14	2.68	26.20	2.78	25.70	2.84	25.31	2.88	24.35	2.96
		30	28	30.18	2.71	29.25	2.80	28.24	2.88	27.72	2.95	27.31	3.00	26.31	3.07
		35	32	32.39	2.81	31.36	2.91	30.29	2.98	29.75	3.05	29.31	3.11	28.25	3.18
		40	36	34.04	2.89	33.08	2.99	32.03	3.07	31.48	3.14	31.03	3.19	29.91	3.28
		45	41	36.10	2.99	35.24	3.09	34.20	3.19	33.64	3.25	33.18	3.29	31.98	3.39
		47	43	36.93	3.03	36.10	3.13	35.07	3.23	<b>34.50</b>	<b>3.29</b>	34.04	3.33	32.80	3.43
		50	46	37.04	3.01	36.29	3.10	35.39	3.19	34.88	3.24	34.47	3.28	33.31	3.37
	55	51	37.22	2.98	36.60	3.06	35.93	3.13	35.51	3.16	35.18	3.19	34.14	3.26	
	60	56	37.40	2.95	36.91	3.01	36.46	3.06	36.15	3.09	35.90	3.10	34.98	3.15	
	63	59	37.51	2.93	37.10	2.98	36.78	3.02	36.53	3.04	36.33	3.05	35.48	3.09	
	68	64	37.62	2.91	37.29	2.95	37.10	2.98	36.91	2.99	36.76	3.00	35.99	3.02	
	9 + 12 + 12	0	-0.4	19.05	2.41	17.94	2.50	17.93	2.54	17.52	2.56	17.19	2.58	16.47	2.67
		5	4.5	22.31	2.47	21.27	2.56	20.95	2.61	20.51	2.64	20.15	2.67	19.34	2.76
		10	9	24.49	2.53	23.50	2.62	22.98	2.68	22.51	2.72	22.14	2.75	21.27	2.84
		17	15	26.89	2.61	25.96	2.69	25.21	2.78	<b>24.71</b>	<b>2.82</b>	24.32	2.86	23.38	2.94
		20	19	28.35	2.66	27.44	2.74	26.56	2.84	26.05	2.89	25.64	2.93	24.67	3.01
		25	23	30.77	2.76	29.86	2.84	28.82	2.94	28.27	3.00	27.84	3.05	26.79	3.13
		30	28	33.20	2.86	32.17	2.96	31.07	3.05	30.50	3.12	30.04	3.17	28.94	3.25
		35	32	35.63	2.97	34.50	3.08	33.32	3.16	32.72	3.23	32.24	3.29	31.08	3.37
		40	36	37.45	3.06	36.39	3.16	35.23	3.25	34.62	3.32	34.13	3.38	32.90	3.46
		45	41	39.72	3.17	38.77	3.27	37.62	3.37	37.00	3.43	36.50	3.48	35.17	3.59
		47	43	40.62	3.21	39.72	3.31	38.58	3.42	<b>37.95</b>	<b>3.48</b>	37.45	3.53	36.08	3.63
		50	46	40.74	3.19	39.92	3.28	38.93	3.38	38.37	3.43	37.92	3.47	36.64	3.56
	55	51	40.94	3.15	40.26	3.23	39.52	3.31	39.07	3.35	38.70	3.38	37.56	3.45	
	60	56	41.14	3.12	40.60	3.18	40.11	3.24	39.76	3.26	39.49	3.28	38.48	3.33	
	63	59	41.26	3.10	40.81	3.15	40.46	3.20	40.18	3.21	39.96	3.23	39.03	3.27	
	68	64	41.38	3.08	41.02	3.12	40.81	3.16	40.60	3.17	40.44	3.17	39.59	3.20	

TC = Total Capacity (kBtu/h).

PI = Power Input (kW).

Nominal capacity as rated: 0 ft. above sea level with 25 ft. of refrigerant piping.  
0 ft. level difference between outdoor and indoor units.

Nominal heating capacity rating obtained with air entering the indoor unit at 70°F dry bulb (DB) and 60°F wet bulb (WB), and outdoor ambient conditions of 47°F dry bulb (DB) and 43°F wet bulb (WB).



Multi F and Multi F MAX Heat Pump System Engineering Manual

Table 105: LMU369HV Heating Capacity Table — Mixed Indoor Units (continued).

Connected Indoor Units	Combination Capacity Index	Outdoor Air Temp.		Indoor Air Temp. °F DB											
		°F DB	°F WB	61		64		68		70		72		75	
				TC	PI	TC	PI	TC	PI	TC	PI	TC	PI	TC	PI
Three (3) Mixed Indoor Units	12 + 12 + 12	0	-0.4	20.58	2.53	19.38	2.62	19.37	2.66	18.93	2.69	18.58	2.70	17.79	2.80
		5	4.5	24.10	2.59	22.98	2.69	22.64	2.74	22.16	2.77	21.77	2.80	20.90	2.89
		10	9	26.46	2.65	25.39	2.75	24.83	2.81	24.32	2.85	23.92	2.88	22.98	2.97
		17	15	29.05	2.74	28.04	2.82	27.23	2.91	26.70	2.96	26.27	3.00	25.26	3.09
		20	19	30.62	2.79	29.65	2.88	28.69	2.98	28.14	3.03	27.70	3.08	26.65	3.16
		25	23	33.24	2.89	32.26	2.98	31.13	3.09	30.55	3.15	30.07	3.20	28.94	3.28
		30	28	35.87	3.00	34.76	3.10	33.56	3.20	32.95	3.27	32.46	3.32	31.26	3.41
		35	32	38.49	3.12	37.27	3.23	36.00	3.31	35.35	3.39	34.83	3.45	33.58	3.53
		40	36	40.46	3.21	39.32	3.32	38.07	3.41	37.41	3.48	36.88	3.54	35.54	3.63
		45	41	42.91	3.32	41.88	3.43	40.65	3.54	39.97	3.60	39.43	3.65	38.00	3.76
		47	43	43.89	3.37	42.91	3.48	41.68	3.59	41.00	3.65	40.46	3.70	38.98	3.81
		50	46	44.02	3.34	43.13	3.44	42.06	3.54	41.45	3.60	40.96	3.64	39.58	3.74
		55	51	44.23	3.31	43.50	3.39	42.69	3.47	42.20	3.51	41.81	3.54	40.58	3.62
		60	56	44.45	3.27	43.87	3.34	43.33	3.40	42.96	3.42	42.66	3.44	41.57	3.50
		63	59	44.58	3.25	44.09	3.30	43.71	3.35	43.41	3.37	43.17	3.39	42.17	3.43
		68	64	44.70	3.23	44.31	3.27	44.09	3.31	43.87	3.32	43.69	3.33	42.77	3.35
	9 + 9 + 18	0	-0.4	20.58	2.53	19.38	2.62	19.37	2.66	18.93	2.69	18.58	2.70	17.79	2.80
		5	4.5	24.10	2.59	22.98	2.69	22.64	2.74	22.16	2.77	21.77	2.80	20.90	2.89
		10	9	26.46	2.65	25.39	2.75	24.83	2.81	24.32	2.85	23.92	2.88	22.98	2.97
		17	15	29.05	2.74	28.04	2.82	27.23	2.91	26.70	2.96	26.27	3.00	25.26	3.09
		20	19	30.62	2.79	29.65	2.88	28.69	2.98	28.14	3.03	27.70	3.08	26.65	3.16
		25	23	33.24	2.89	32.26	2.98	31.13	3.09	30.55	3.15	30.07	3.20	28.94	3.28
		30	28	35.87	3.00	34.76	3.10	33.56	3.20	32.95	3.27	32.46	3.32	31.26	3.41
		35	32	38.49	3.12	37.27	3.23	36.00	3.31	35.35	3.39	34.83	3.45	33.58	3.53
		40	36	40.46	3.21	39.32	3.32	38.07	3.41	37.41	3.48	36.88	3.54	35.54	3.63
		45	41	42.91	3.32	41.88	3.43	40.65	3.54	39.97	3.60	39.43	3.65	38.00	3.76
		47	43	43.89	3.37	42.91	3.48	41.68	3.59	41.00	3.65	40.46	3.70	38.98	3.81
		50	46	44.02	3.34	43.13	3.44	42.06	3.54	41.45	3.60	40.96	3.64	39.58	3.74
		55	51	44.23	3.31	43.50	3.39	42.69	3.47	42.20	3.51	41.81	3.54	40.58	3.62
		60	56	44.45	3.27	43.87	3.34	43.33	3.40	42.96	3.42	42.66	3.44	41.57	3.50
		63	59	44.58	3.25	44.09	3.30	43.71	3.35	43.41	3.37	43.17	3.39	42.17	3.43
		68	64	44.70	3.23	44.31	3.27	44.09	3.31	43.87	3.32	43.69	3.33	42.77	3.35
	9 + 12 + 18	0	-0.4	20.58	2.53	19.38	2.62	19.37	2.66	18.93	2.69	18.58	2.70	17.79	2.80
		5	4.5	24.10	2.59	22.98	2.69	22.64	2.74	22.16	2.77	21.77	2.80	20.90	2.89
		10	9	26.46	2.65	25.39	2.75	24.83	2.81	24.32	2.85	23.92	2.88	22.98	2.97
		17	15	29.05	2.74	28.04	2.82	27.23	2.91	26.70	2.96	26.27	3.00	25.26	3.09
		20	19	30.62	2.79	29.65	2.88	28.69	2.98	28.14	3.03	27.70	3.08	26.65	3.16
		25	23	33.24	2.89	32.26	2.98	31.13	3.09	30.55	3.15	30.07	3.20	28.94	3.28
		30	28	35.87	3.00	34.76	3.10	33.56	3.20	32.95	3.27	32.46	3.32	31.26	3.41
		35	32	38.49	3.12	37.27	3.23	36.00	3.31	35.35	3.39	34.83	3.45	33.58	3.53
		40	36	40.46	3.21	39.32	3.32	38.07	3.41	37.41	3.48	36.88	3.54	35.54	3.63
		45	41	42.91	3.32	41.88	3.43	40.65	3.54	39.97	3.60	39.43	3.65	38.00	3.76
		47	43	43.89	3.37	42.91	3.48	41.68	3.59	41.00	3.65	40.46	3.70	38.98	3.81
		50	46	44.02	3.34	43.13	3.44	42.06	3.54	41.45	3.60	40.96	3.64	39.58	3.74
		55	51	44.23	3.31	43.50	3.39	42.69	3.47	42.20	3.51	41.81	3.54	40.58	3.62
		60	56	44.45	3.27	43.87	3.34	43.33	3.40	42.96	3.42	42.66	3.44	41.57	3.50
		63	59	44.58	3.25	44.09	3.30	43.71	3.35	43.41	3.37	43.17	3.39	42.17	3.43
		68	64	44.70	3.23	44.31	3.27	44.09	3.31	43.87	3.32	43.69	3.33	42.77	3.35

TC = Total Capacity (kBtu/h).

PI = Power Input (kW).

Nominal capacity as rated: 0 ft. above sea level with 25 ft. of refrigerant piping.  
0 ft. level difference between outdoor and indoor units.

Nominal heating capacity rating obtained with air entering the indoor unit at 70°F dry bulb (DB) and 60°F wet bulb (WB), and outdoor ambient conditions of 47°F dry bulb (DB) and 43°F wet bulb (WB).

Multi F Outdoor Unit Data

# PERFORMANCE DATA

## Heating Capacity Tables

MULTI F  
MULTI F MAX

Table 106: LMU369HV Heating Capacity Table — Mixed Indoor Units (continued).

Connected Indoor Units	Combination Capacity Index	Outdoor Air Temp.		Indoor Air Temp. °F DB											
		°F DB	°F WB	61		64		68		70		72		75	
				TC	PI	TC	PI	TC	PI	TC	PI	TC	PI	TC	PI
Three (3) Mixed Indoor Units	12 + 12 + 18	0	-0.4	20.58	2.53	19.38	2.62	19.37	2.66	18.93	2.69	18.58	2.70	17.79	2.80
		5	4.5	24.10	2.59	22.98	2.69	22.64	2.74	22.16	2.77	21.77	2.80	20.90	2.89
		10	9	26.46	2.65	25.39	2.75	24.83	2.81	24.32	2.85	23.92	2.88	22.98	2.97
		17	15	29.05	2.74	28.04	2.82	27.23	2.91	<b>26.70</b>	<b>2.96</b>	26.27	3.00	25.26	3.09
		20	19	30.62	2.79	29.65	2.88	28.69	2.98	28.14	3.03	27.70	3.08	26.65	3.16
		25	23	33.24	2.89	32.26	2.98	31.13	3.09	30.55	3.15	30.07	3.20	28.94	3.28
		30	28	35.87	3.00	34.76	3.10	33.56	3.20	32.95	3.27	32.46	3.32	31.26	3.41
		35	32	38.49	3.12	37.27	3.23	36.00	3.31	35.35	3.39	34.83	3.45	33.58	3.53
		40	36	40.46	3.21	39.32	3.32	38.07	3.41	37.41	3.48	36.88	3.54	35.54	3.63
		45	41	42.91	3.32	41.88	3.43	40.65	3.54	39.97	3.60	39.43	3.65	38.00	3.76
		47	43	43.89	3.37	42.91	3.48	41.68	3.59	<b>41.00</b>	<b>3.65</b>	40.46	3.70	38.98	3.81
		50	46	44.02	3.34	43.13	3.44	42.06	3.54	41.45	3.60	40.96	3.64	39.58	3.74
		55	51	44.23	3.31	43.50	3.39	42.69	3.47	42.20	3.51	41.81	3.54	40.58	3.62
		60	56	44.45	3.27	43.87	3.34	43.33	3.40	42.96	3.42	42.66	3.44	41.57	3.50
		63	59	44.58	3.25	44.09	3.30	43.71	3.35	43.41	3.37	43.17	3.39	42.17	3.43
		68	64	44.70	3.23	44.31	3.27	44.09	3.31	43.87	3.32	43.69	3.33	42.77	3.35
	9 + 18 + 18	0	-0.4	20.58	2.53	19.38	2.62	19.37	2.66	18.93	2.69	18.58	2.70	17.79	2.80
		5	4.5	24.10	2.59	22.98	2.69	22.64	2.74	22.16	2.77	21.77	2.80	20.90	2.89
		10	9	26.46	2.65	25.39	2.75	24.83	2.81	24.32	2.85	23.92	2.88	22.98	2.97
		17	15	29.05	2.74	28.04	2.82	27.23	2.91	<b>26.70</b>	<b>2.96</b>	26.27	3.00	25.26	3.09
		20	19	30.62	2.79	29.65	2.88	28.69	2.98	28.14	3.03	27.70	3.08	26.65	3.16
		25	23	33.24	2.89	32.26	2.98	31.13	3.09	30.55	3.15	30.07	3.20	28.94	3.28
		30	28	35.87	3.00	34.76	3.10	33.56	3.20	32.95	3.27	32.46	3.32	31.26	3.41
		35	32	38.49	3.12	37.27	3.23	36.00	3.31	35.35	3.39	34.83	3.45	33.58	3.53
		40	36	40.46	3.21	39.32	3.32	38.07	3.41	37.41	3.48	36.88	3.54	35.54	3.63
		45	41	42.91	3.32	41.88	3.43	40.65	3.54	39.97	3.60	39.43	3.65	38.00	3.76
		47	43	43.89	3.37	42.91	3.48	41.68	3.59	<b>41.00</b>	<b>3.65</b>	40.46	3.70	38.98	3.81
		50	46	44.02	3.34	43.13	3.44	42.06	3.54	41.45	3.60	40.96	3.64	39.58	3.74
		55	51	44.23	3.31	43.50	3.39	42.69	3.47	42.20	3.51	41.81	3.54	40.58	3.62
		60	56	44.45	3.27	43.87	3.34	43.33	3.40	42.96	3.42	42.66	3.44	41.57	3.50
		63	59	44.58	3.25	44.09	3.30	43.71	3.35	43.41	3.37	43.17	3.39	42.17	3.43
		68	64	44.70	3.23	44.31	3.27	44.09	3.31	43.87	3.32	43.69	3.33	42.77	3.35
	12 + 18 + 18	0	-0.4	20.58	2.53	19.38	2.62	19.37	2.66	18.93	2.69	18.58	2.70	17.79	2.80
		5	4.5	24.10	2.59	22.98	2.69	22.64	2.74	22.16	2.77	21.77	2.80	20.90	2.89
		10	9	26.46	2.65	25.39	2.75	24.83	2.81	24.32	2.85	23.92	2.88	22.98	2.97
		17	15	29.05	2.74	28.04	2.82	27.23	2.91	<b>26.70</b>	<b>2.96</b>	26.27	3.00	25.26	3.09
		20	19	30.62	2.79	29.65	2.88	28.69	2.98	28.14	3.03	27.70	3.08	26.65	3.16
		25	23	33.24	2.89	32.26	2.98	31.13	3.09	30.55	3.15	30.07	3.20	28.94	3.28
		30	28	35.87	3.00	34.76	3.10	33.56	3.20	32.95	3.27	32.46	3.32	31.26	3.41
		35	32	38.49	3.12	37.27	3.23	36.00	3.31	35.35	3.39	34.83	3.45	33.58	3.53
		40	36	40.46	3.21	39.32	3.32	38.07	3.41	37.41	3.48	36.88	3.54	35.54	3.63
		45	41	42.91	3.32	41.88	3.43	40.65	3.54	39.97	3.60	39.43	3.65	38.00	3.76
		47	43	43.89	3.37	42.91	3.48	41.68	3.59	<b>41.00</b>	<b>3.65</b>	40.46	3.70	38.98	3.81
		50	46	44.02	3.34	43.13	3.44	42.06	3.54	41.45	3.60	40.96	3.64	39.58	3.74
		55	51	44.23	3.31	43.50	3.39	42.69	3.47	42.20	3.51	41.81	3.54	40.58	3.62
		60	56	44.45	3.27	43.87	3.34	43.33	3.40	42.96	3.42	42.66	3.44	41.57	3.50
		63	59	44.58	3.25	44.09	3.30	43.71	3.35	43.41	3.37	43.17	3.39	42.17	3.43
		68	64	44.70	3.23	44.31	3.27	44.09	3.31	43.87	3.32	43.69	3.33	42.77	3.35

TC = Total Capacity (kBtu/h).

PI = Power Input (kW).

Nominal capacity as rated: 0 ft. above sea level with 25 ft. of refrigerant piping.  
0 ft. level difference between outdoor and indoor units.

Nominal heating capacity rating obtained with air entering the indoor unit at 70°F dry bulb (DB) and 60°F wet bulb (WB), and outdoor ambient conditions of 47°F dry bulb (DB) and 43°F wet bulb (WB).

Multi F and Multi F MAX Heat Pump System Engineering Manual

Table 107: LMU369HV Heating Capacity Table — Mixed Indoor Units (continued).

Connected Indoor Units	Combination Capacity Index	Outdoor Air Temp.		Indoor Air Temp. °F DB												
		°F DB	°F WB	61		64		68		70		72		75		
				TC	PI	TC	PI	TC	PI	TC	PI	TC	PI	TC	PI	
Four (4) Mixed Indoor Units	9 + 9 + 9 + 9	0	-0.4	20.58	2.53	19.38	2.62	19.37	2.66	18.93	2.69	18.58	2.70	17.79	2.80	
		5	4.5	24.10	2.59	22.98	2.69	22.64	2.74	22.16	2.77	21.77	2.80	20.90	2.89	
		10	9	26.46	2.65	25.39	2.75	24.83	2.81	24.32	2.85	23.92	2.88	22.98	2.97	
		17	15	29.05	2.74	28.04	2.82	27.23	2.91	<b>26.70</b>	<b>2.96</b>	26.27	3.00	25.26	3.09	
		20	19	30.62	2.79	29.65	2.88	28.69	2.98	28.14	3.03	27.70	3.08	26.65	3.16	
		25	23	33.24	2.89	32.26	2.98	31.13	3.09	30.55	3.15	30.07	3.20	28.94	3.28	
		30	28	35.87	3.00	34.76	3.10	33.56	3.20	32.95	3.27	32.46	3.32	31.26	3.41	
		35	32	38.49	3.12	37.27	3.23	36.00	3.31	35.35	3.39	34.83	3.45	33.58	3.53	
		40	36	40.46	3.21	39.32	3.32	38.07	3.41	37.41	3.48	36.88	3.54	35.54	3.63	
		45	41	42.91	3.32	41.88	3.43	40.65	3.54	39.97	3.60	39.43	3.65	38.00	3.76	
		47	43	43.89	3.37	42.91	3.48	41.68	3.59	<b>41.00</b>	<b>3.65</b>	40.46	3.70	38.98	3.81	
		50	46	44.02	3.34	43.13	3.44	42.06	3.54	41.45	3.60	40.96	3.64	39.58	3.74	
		55	51	44.23	3.31	43.50	3.39	42.69	3.47	42.20	3.51	41.81	3.54	40.58	3.62	
		60	56	44.45	3.27	43.87	3.34	43.33	3.40	42.96	3.42	42.66	3.44	41.57	3.50	
		63	59	44.58	3.25	44.09	3.30	43.71	3.35	43.41	3.37	43.17	3.39	42.17	3.43	
		68	64	44.70	3.23	44.31	3.27	44.09	3.31	43.87	3.32	43.69	3.33	42.77	3.35	
		9 + 9 + 9 + 12	0	-0.4	20.58	2.53	19.38	2.62	19.37	2.66	18.93	2.69	18.58	2.70	17.79	2.80
			5	4.5	24.10	2.59	22.98	2.69	22.64	2.74	22.16	2.77	21.77	2.80	20.90	2.89
	10		9	26.46	2.65	25.39	2.75	24.83	2.81	24.32	2.85	23.92	2.88	22.98	2.97	
	17		15	29.05	2.74	28.04	2.82	27.23	2.91	<b>26.70</b>	<b>2.96</b>	26.27	3.00	25.26	3.09	
	20		19	30.62	2.79	29.65	2.88	28.69	2.98	28.14	3.03	27.70	3.08	26.65	3.16	
	25		23	33.24	2.89	32.26	2.98	31.13	3.09	30.55	3.15	30.07	3.20	28.94	3.28	
	30		28	35.87	3.00	34.76	3.10	33.56	3.20	32.95	3.27	32.46	3.32	31.26	3.41	
	35		32	38.49	3.12	37.27	3.23	36.00	3.31	35.35	3.39	34.83	3.45	33.58	3.53	
	40		36	40.46	3.21	39.32	3.32	38.07	3.41	37.41	3.48	36.88	3.54	35.54	3.63	
	45		41	42.91	3.32	41.88	3.43	40.65	3.54	39.97	3.60	39.43	3.65	38.00	3.76	
	47		43	43.89	3.37	42.91	3.48	41.68	3.59	<b>41.00</b>	<b>3.65</b>	40.46	3.70	38.98	3.81	
	50		46	44.02	3.34	43.13	3.44	42.06	3.54	41.45	3.60	40.96	3.64	39.58	3.74	
	55		51	44.23	3.31	43.50	3.39	42.69	3.47	42.20	3.51	41.81	3.54	40.58	3.62	
	60		56	44.45	3.27	43.87	3.34	43.33	3.40	42.96	3.42	42.66	3.44	41.57	3.50	
	63		59	44.58	3.25	44.09	3.30	43.71	3.35	43.41	3.37	43.17	3.39	42.17	3.43	
	68		64	44.70	3.23	44.31	3.27	44.09	3.31	43.87	3.32	43.69	3.33	42.77	3.35	
	9 + 9 + 12 + 12		0	-0.4	20.58	2.53	19.38	2.62	19.37	2.66	18.93	2.69	18.58	2.70	17.79	2.80
			5	4.5	24.10	2.59	22.98	2.69	22.64	2.74	22.16	2.77	21.77	2.80	20.90	2.89
		10	9	26.46	2.65	25.39	2.75	24.83	2.81	24.32	2.85	23.92	2.88	22.98	2.97	
		17	15	29.05	2.74	28.04	2.82	27.23	2.91	<b>26.70</b>	<b>2.96</b>	26.27	3.00	25.26	3.09	
		20	19	30.62	2.79	29.65	2.88	28.69	2.98	28.14	3.03	27.70	3.08	26.65	3.16	
		25	23	33.24	2.89	32.26	2.98	31.13	3.09	30.55	3.15	30.07	3.20	28.94	3.28	
		30	28	35.87	3.00	34.76	3.10	33.56	3.20	32.95	3.27	32.46	3.32	31.26	3.41	
		35	32	38.49	3.12	37.27	3.23	36.00	3.31	35.35	3.39	34.83	3.45	33.58	3.53	
		40	36	40.46	3.21	39.32	3.32	38.07	3.41	37.41	3.48	36.88	3.54	35.54	3.63	
		45	41	42.91	3.32	41.88	3.43	40.65	3.54	39.97	3.60	39.43	3.65	38.00	3.76	
		47	43	43.89	3.37	42.91	3.48	41.68	3.59	<b>41.00</b>	<b>3.65</b>	40.46	3.70	38.98	3.81	
		50	46	44.02	3.34	43.13	3.44	42.06	3.54	41.45	3.60	40.96	3.64	39.58	3.74	

TC = Total Capacity (kBtu/h).

PI = Power Input (kW).

Nominal capacity as rated: 0 ft. above sea level with 25 ft. of refrigerant piping.  
0 ft. level difference between outdoor and indoor units.

Nominal heating capacity rating obtained with air entering the indoor unit at 70°F dry bulb (DB) and 60°F wet bulb (WB), and outdoor ambient conditions of 47°F dry bulb (DB) and 43°F wet bulb (WB).

# PERFORMANCE DATA

## Heating Capacity Tables

MULTI F  
MULTI F MAX

Table 108: LMU369HV Heating Capacity Table — Mixed Indoor Units (continued).

Connected Indoor Units	Combination Capacity Index	Outdoor Air Temp.		Indoor Air Temp. °F DB											
		°F DB	°F WB	61		64		68		70		72		75	
				TC	PI	TC	PI	TC	PI	TC	PI	TC	PI	TC	PI
Four (4) Mixed Indoor Units	9 + 12 + 12 + 12	0	-0.4	20.58	2.53	19.38	2.62	19.37	2.66	18.93	2.69	18.58	2.70	17.79	2.80
		5	4.5	24.10	2.59	22.98	2.69	22.64	2.74	22.16	2.77	21.77	2.80	20.90	2.89
		10	9	26.46	2.65	25.39	2.75	24.83	2.81	24.32	2.85	23.92	2.88	22.98	2.97
		17	15	29.05	2.74	28.04	2.82	27.23	2.91	<b>26.70</b>	<b>2.96</b>	26.27	3.00	25.26	3.09
		20	19	30.62	2.79	29.65	2.88	28.69	2.98	28.14	3.03	27.70	3.08	26.65	3.16
		25	23	33.24	2.89	32.26	2.98	31.13	3.09	30.55	3.15	30.07	3.20	28.94	3.28
		30	28	35.87	3.00	34.76	3.10	33.56	3.20	32.95	3.27	32.46	3.32	31.26	3.41
		35	32	38.49	3.12	37.27	3.23	36.00	3.31	35.35	3.39	34.83	3.45	33.58	3.53
		40	36	40.46	3.21	39.32	3.32	38.07	3.41	37.41	3.48	36.88	3.54	35.54	3.63
		45	41	42.91	3.32	41.88	3.43	40.65	3.54	39.97	3.60	39.43	3.65	38.00	3.76
		47	43	43.89	3.37	42.91	3.48	41.68	3.59	<b>41.00</b>	<b>3.65</b>	40.46	3.70	38.98	3.81
		50	46	44.02	3.34	43.13	3.44	42.06	3.54	41.45	3.60	40.96	3.64	39.58	3.74
		55	51	44.23	3.31	43.50	3.39	42.69	3.47	42.20	3.51	41.81	3.54	40.58	3.62
		60	56	44.45	3.27	43.87	3.34	43.33	3.40	42.96	3.42	42.66	3.44	41.57	3.50
		63	59	44.58	3.25	44.09	3.30	43.71	3.35	43.41	3.37	43.17	3.39	42.17	3.43
		68	64	44.70	3.23	44.31	3.27	44.09	3.31	43.87	3.32	43.69	3.33	42.77	3.35
	9 + 9 + 9 + 18	0	-0.4	20.58	2.53	19.38	2.62	19.37	2.66	18.93	2.69	18.58	2.70	17.79	2.80
		5	4.5	24.10	2.59	22.98	2.69	22.64	2.74	22.16	2.77	21.77	2.80	20.90	2.89
		10	9	26.46	2.65	25.39	2.75	24.83	2.81	24.32	2.85	23.92	2.88	22.98	2.97
		17	15	29.05	2.74	28.04	2.82	27.23	2.91	<b>26.70</b>	<b>2.96</b>	26.27	3.00	25.26	3.09
		20	19	30.62	2.79	29.65	2.88	28.69	2.98	28.14	3.03	27.70	3.08	26.65	3.16
		25	23	33.24	2.89	32.26	2.98	31.13	3.09	30.55	3.15	30.07	3.20	28.94	3.28
		30	28	35.87	3.00	34.76	3.10	33.56	3.20	32.95	3.27	32.46	3.32	31.26	3.41
		35	32	38.49	3.12	37.27	3.23	36.00	3.31	35.35	3.39	34.83	3.45	33.58	3.53
		40	36	40.46	3.21	39.32	3.32	38.07	3.41	37.41	3.48	36.88	3.54	35.54	3.63
		45	41	42.91	3.32	41.88	3.43	40.65	3.54	39.97	3.60	39.43	3.65	38.00	3.76
		47	43	43.89	3.37	42.91	3.48	41.68	3.59	<b>41.00</b>	<b>3.65</b>	40.46	3.70	38.98	3.81
		50	46	44.02	3.34	43.13	3.44	42.06	3.54	41.45	3.60	40.96	3.64	39.58	3.74
		55	51	44.23	3.31	43.50	3.39	42.69	3.47	42.20	3.51	41.81	3.54	40.58	3.62
		60	56	44.45	3.27	43.87	3.34	43.33	3.40	42.96	3.42	42.66	3.44	41.57	3.50
		63	59	44.58	3.25	44.09	3.30	43.71	3.35	43.41	3.37	43.17	3.39	42.17	3.43
		68	64	44.70	3.23	44.31	3.27	44.09	3.31	43.87	3.32	43.69	3.33	42.77	3.35
	9 + 9 + 12 + 18	0	-0.4	20.58	2.53	19.38	2.62	19.37	2.66	18.93	2.69	18.58	2.70	17.79	2.80
		5	4.5	24.10	2.59	22.98	2.69	22.64	2.74	22.16	2.77	21.77	2.80	20.90	2.89
		10	9	26.46	2.65	25.39	2.75	24.83	2.81	24.32	2.85	23.92	2.88	22.98	2.97
		17	15	29.05	2.74	28.04	2.82	27.23	2.91	<b>26.70</b>	<b>2.96</b>	26.27	3.00	25.26	3.09
		20	19	30.62	2.79	29.65	2.88	28.69	2.98	28.14	3.03	27.70	3.08	26.65	3.16
		25	23	33.24	2.89	32.26	2.98	31.13	3.09	30.55	3.15	30.07	3.20	28.94	3.28
		30	28	35.87	3.00	34.76	3.10	33.56	3.20	32.95	3.27	32.46	3.32	31.26	3.41
		35	32	38.49	3.12	37.27	3.23	36.00	3.31	35.35	3.39	34.83	3.45	33.58	3.53
		40	36	40.46	3.21	39.32	3.32	38.07	3.41	37.41	3.48	36.88	3.54	35.54	3.63
		45	41	42.91	3.32	41.88	3.43	40.65	3.54	39.97	3.60	39.43	3.65	38.00	3.76
		47	43	43.89	3.37	42.91	3.48	41.68	3.59	<b>41.00</b>	<b>3.65</b>	40.46	3.70	38.98	3.81
		50	46	44.02	3.34	43.13	3.44	42.06	3.54	41.45	3.60	40.96	3.64	39.58	3.74
		55	51	44.23	3.31	43.50	3.39	42.69	3.47	42.20	3.51	41.81	3.54	40.58	3.62
		60	56	44.45	3.27	43.87	3.34	43.33	3.40	42.96	3.42	42.66	3.44	41.57	3.50
		63	59	44.58	3.25	44.09	3.30	43.71	3.35	43.41	3.37	43.17	3.39	42.17	3.43
		68	64	44.70	3.23	44.31	3.27	44.09	3.31	43.87	3.32	43.69	3.33	42.77	3.35

TC = Total Capacity (kBtu/h).

PI = Power Input (kW).

Nominal capacity as rated: 0 ft. above sea level with 25 ft. of refrigerant piping.  
0 ft. level difference between outdoor and indoor units.

Nominal heating capacity rating obtained with air entering the indoor unit at 70°F dry bulb (DB) and 60°F wet bulb (WB), and outdoor ambient conditions of 47°F dry bulb (DB) and 43°F wet bulb (WB).



Multi F and Multi F MAX Heat Pump System Engineering Manual

Table 109: LMU369HV Heating Capacity Table — Mixed Indoor Units (continued).

Connected Indoor Units	Combination Capacity Index	Outdoor Air Temp.		Indoor Air Temp. °F DB											
		°F DB	°F WB	61		64		68		70		72		75	
				TC	PI	TC	PI	TC	PI	TC	PI	TC	PI	TC	PI
Four (4) Mixed Indoor Units	12 + 12 + 12 + 12	0	-0.4	20.58	2.53	19.38	2.62	19.37	2.66	18.93	2.69	18.58	2.70	17.79	2.80
		5	4.5	24.10	2.59	22.98	2.69	22.64	2.74	22.16	2.77	21.77	2.80	20.90	2.89
		10	9	26.46	2.65	25.39	2.75	24.83	2.81	24.32	2.85	23.92	2.88	22.98	2.97
		17	15	29.05	2.74	28.04	2.82	27.23	2.91	<b>26.70</b>	<b>2.96</b>	26.27	3.00	25.26	3.09
		20	19	30.62	2.79	29.65	2.88	28.69	2.98	28.14	3.03	27.70	3.08	26.65	3.16
		25	23	33.24	2.89	32.26	2.98	31.13	3.09	30.55	3.15	30.07	3.20	28.94	3.28
		30	28	35.87	3.00	34.76	3.10	33.56	3.20	32.95	3.27	32.46	3.32	31.26	3.41
		35	32	38.49	3.12	37.27	3.23	36.00	3.31	35.35	3.39	34.83	3.45	33.58	3.53
		40	36	40.46	3.21	39.32	3.32	38.07	3.41	37.41	3.48	36.88	3.54	35.54	3.63
		45	41	42.91	3.32	41.88	3.43	40.65	3.54	39.97	3.60	39.43	3.65	38.00	3.76
		47	43	43.89	3.37	42.91	3.48	41.68	3.59	<b>41.00</b>	<b>3.65</b>	40.46	3.70	38.98	3.81
		50	46	44.02	3.34	43.13	3.44	42.06	3.54	41.45	3.60	40.96	3.64	39.58	3.74
		55	51	44.23	3.31	43.50	3.39	42.69	3.47	42.20	3.51	41.81	3.54	40.58	3.62
		60	56	44.45	3.27	43.87	3.34	43.33	3.40	42.96	3.42	42.66	3.44	41.57	3.50
		63	59	44.58	3.25	44.09	3.30	43.71	3.35	43.41	3.37	43.17	3.39	42.17	3.43
68	64	44.70	3.23	44.31	3.27	44.09	3.31	43.87	3.32	43.69	3.33	42.77	3.35		

TC = Total Capacity (kBtu/h).

PI = Power Input (kW).

Nominal capacity as rated: 0 ft. above sea level with 25 ft. of refrigerant piping.  
0 ft. level difference between outdoor and indoor units.

Nominal heating capacity rating obtained with air entering the indoor unit at 70°F dry bulb (DB) and 60°F wet bulb (WB), and outdoor ambient conditions of 47°F dry bulb (DB) and 43°F wet bulb (WB).

# MULTI F OUTDOOR UNIT

## Electrical and Acoustic Data

MULTI F  
MULTI F MAX

### Electrical Data

Table 110: Electrical Data.

Nominal Tons	Unit Model No.	Hertz	Voltage	Voltage Range (Min. to Max.)	MCA	MOP	Compressor Quantity	Compressor Motor RLA	Condenser Fan Motor(s)	
									Condenser Fan Quantity.	Condenser Fan Motor FLA
1.5	LMU187HV	60	208 - 230	187 - 253	11.0	15	1	8.2	1	0.40
2	LMU247HV				15.4	25	1	11.6	1	0.40
3	LMU369HV				16.8	25	1	12.1	2	0.55 x 2

Voltage tolerance is  $\pm 10\%$ .

Maximum allowable voltage unbalance is 2%.

RLA = Rated Load Amps.

MCA = Minimum Circuit Ampacity.

Maximum Overcurrent Protection (MOP) is calculated as follows:  
(Largest motor FLA x 2.25) + (Sum of other motor FLA) rounded down to the nearest standard fuse size.

### Acoustic Data

Figure 9: Acoustic Measurement Location.

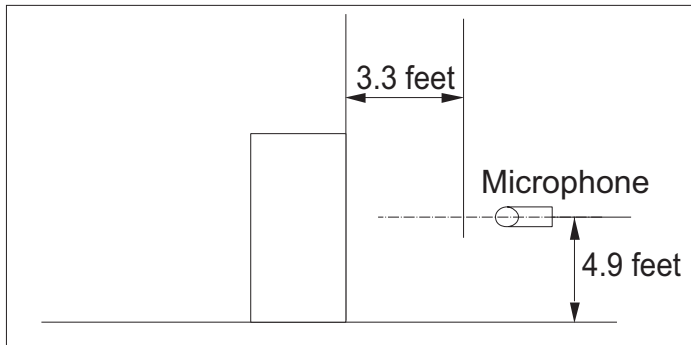

- Measurement taken 4.9' above finished floor, and at a distance of 3.3' from face of unit.
- Measurements taken with no attenuation and units operating at full load normal operating condition.
- Sound level will vary depending on a range of factors such as construction (acoustic absorption coefficient) of particular area in which the equipment is installed.
- Sound level may be increased in static pressure mode or if air guide is used.
- Sound pressure levels are measured in dB(A) $\pm 3$ .
- Tested in anechoic chamber per ISO Standard 3745.

Table 111: Sound Pressure Levels (dB[A]).

Model No.	Sound Pressure Level (dB[A])
LMU187HV	51
LMU247HV	51
LMU369HV	57

Figure 10: Sound Pressure Level Diagrams.

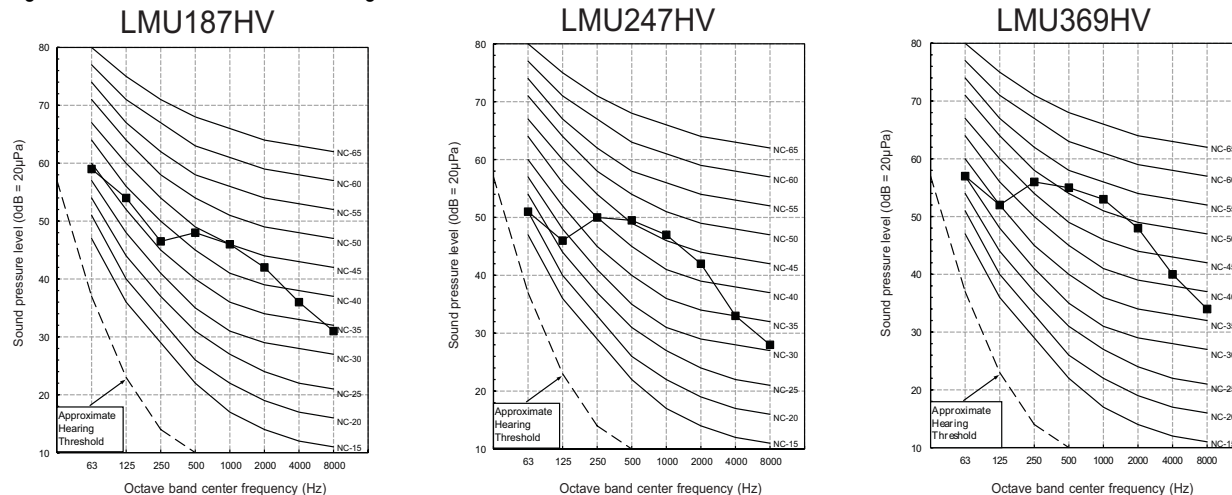

Figure 11: LMU187HV Refrigerant Flow Diagram.

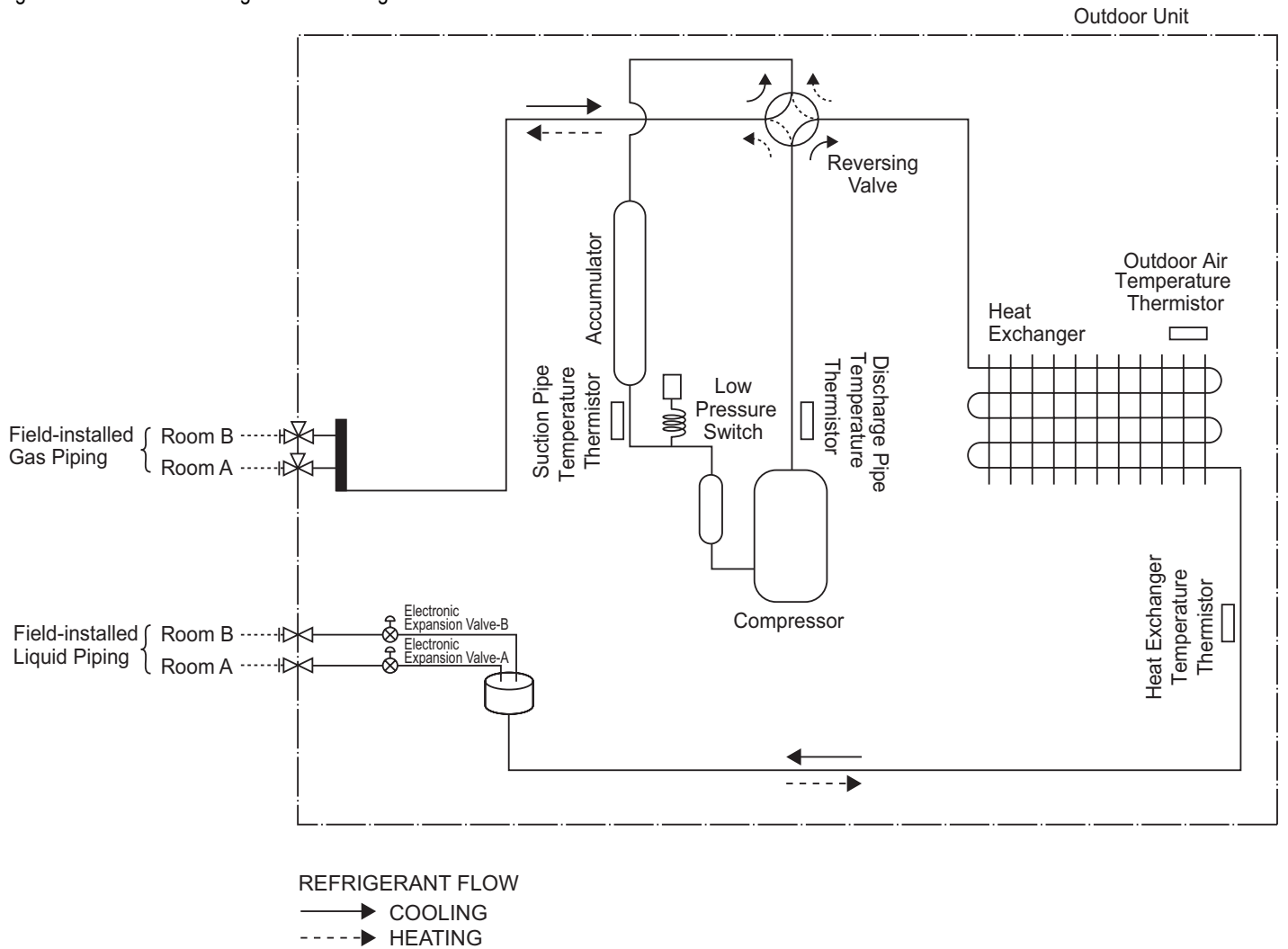

Table 112: LMU187HV Thermistor Details.

Description	PCB Connector
Outdoor Air Temperature Thermistor	CN-TH2
Heat Exchanger Temperature Thermistor	
Discharge Pipe Temperature Thermistor	CN-TH3
Suction Pipe Temperature Thermistor	

# MULTI F OUTDOOR UNIT

## Refrigerant Flow Diagram

MULTI F  
MULTI F MAX

Figure 12: LMU247HV Refrigerant Flow Diagram.

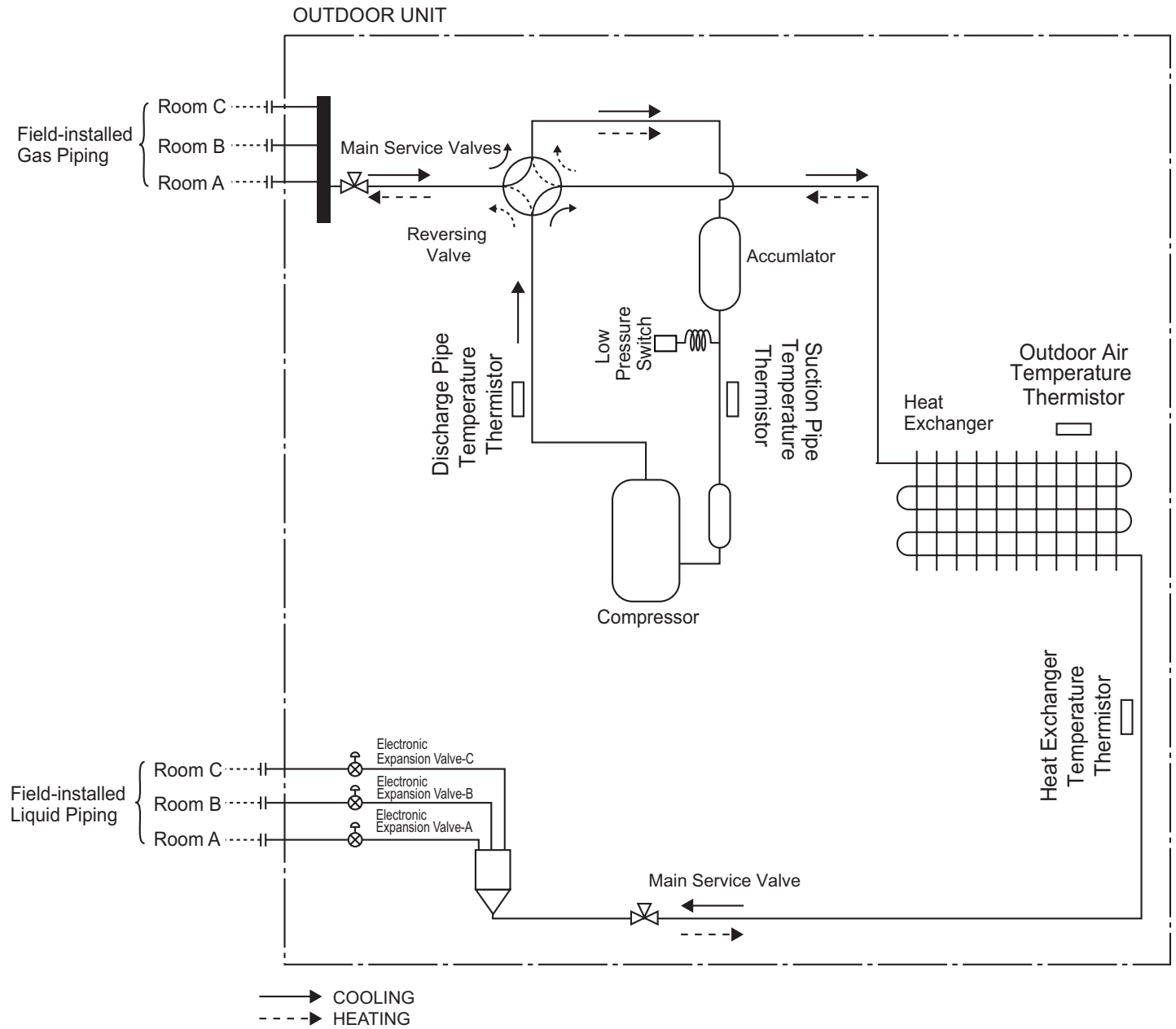

Table 113: LMU247HV Thermistor Details.

Description	PCB Connector
Outdoor Air Temperature Thermistor	CN-TH2
Heat Exchanger Temperature Thermistor	
Discharge Pipe Temperature Thermistor	CN-TH3
Suction Pipe Temperature Thermistor	

Figure 13: LMU369HV Refrigerant Flow Diagram.

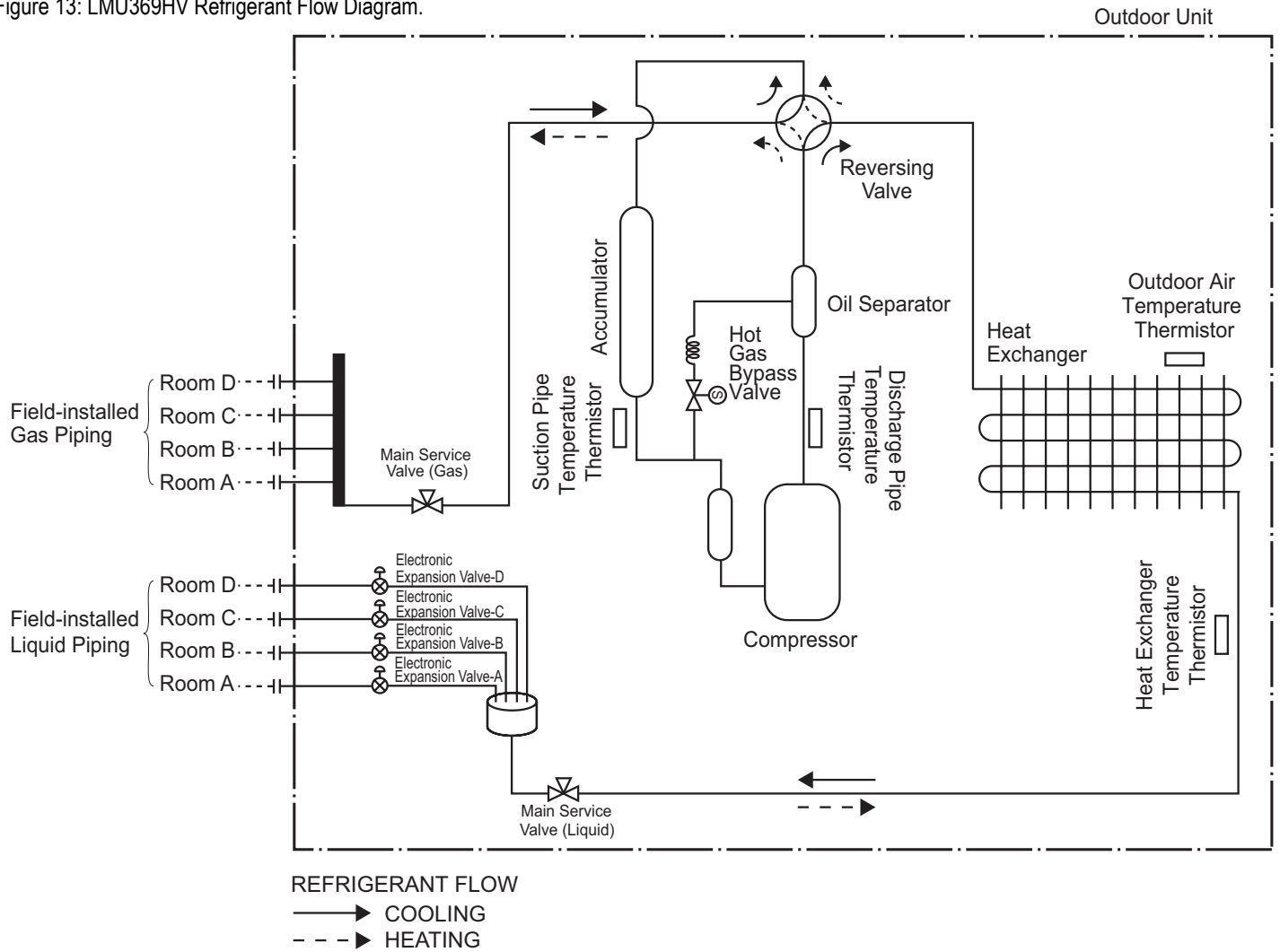

Table 114: LMU369HV Thermistor Details.

Description	PCB Connector
Outdoor Air Temperature Thermistor	CN-TH2
Heat Exchanger Temperature Thermistor	
Discharge Pipe Temperature Thermistor	CN-TH3
Suction Pipe Temperature Thermistor	

# MULTI F OUTDOOR UNIT

## Wiring Diagram

MULTI F  
MULTI F MAX

Figure 14: LMU187HV Wiring Diagram.

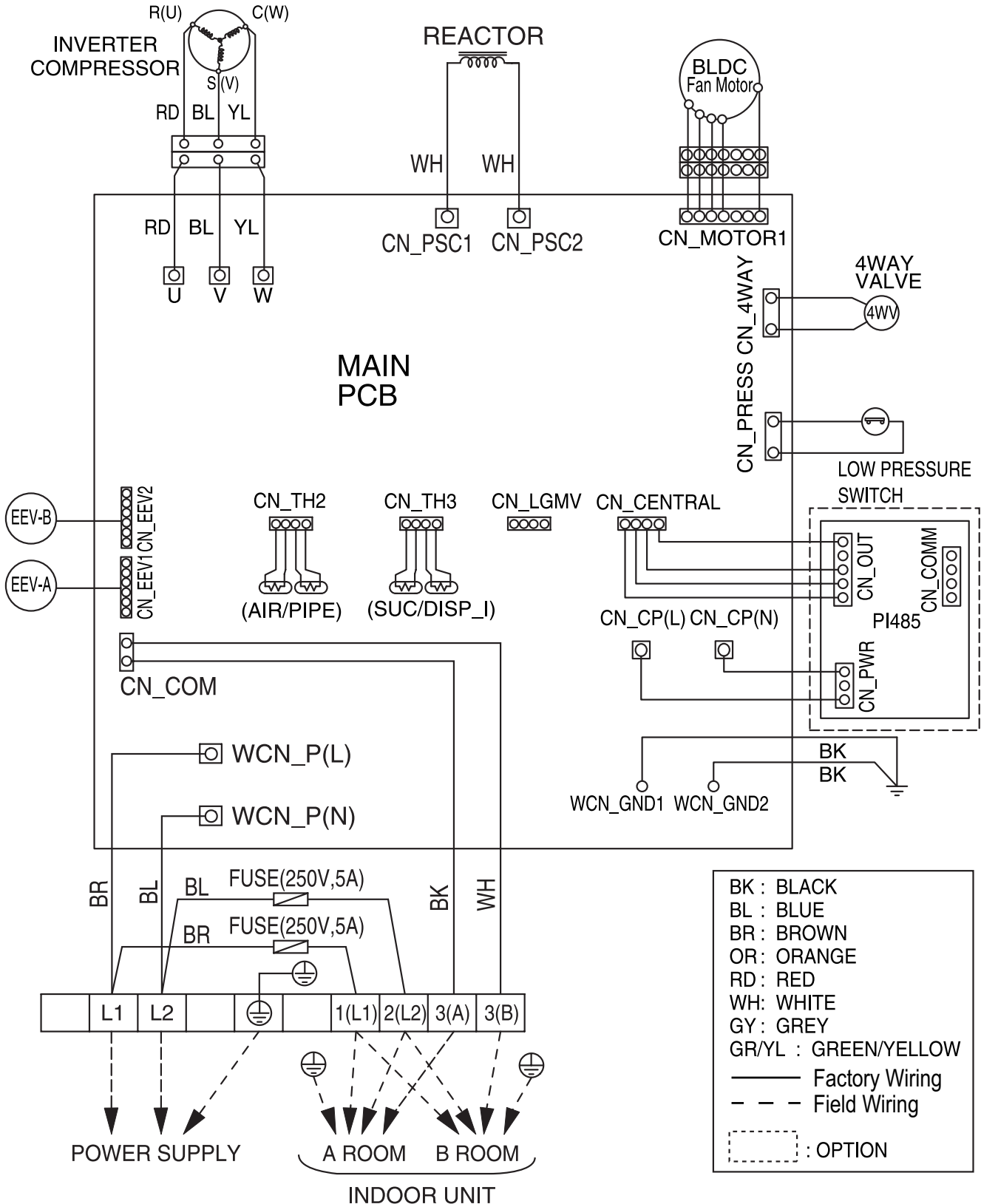

Multi F and Multi F MAX Heat Pump System Engineering Manual

Figure 15: LMU247HV Wiring Diagram.

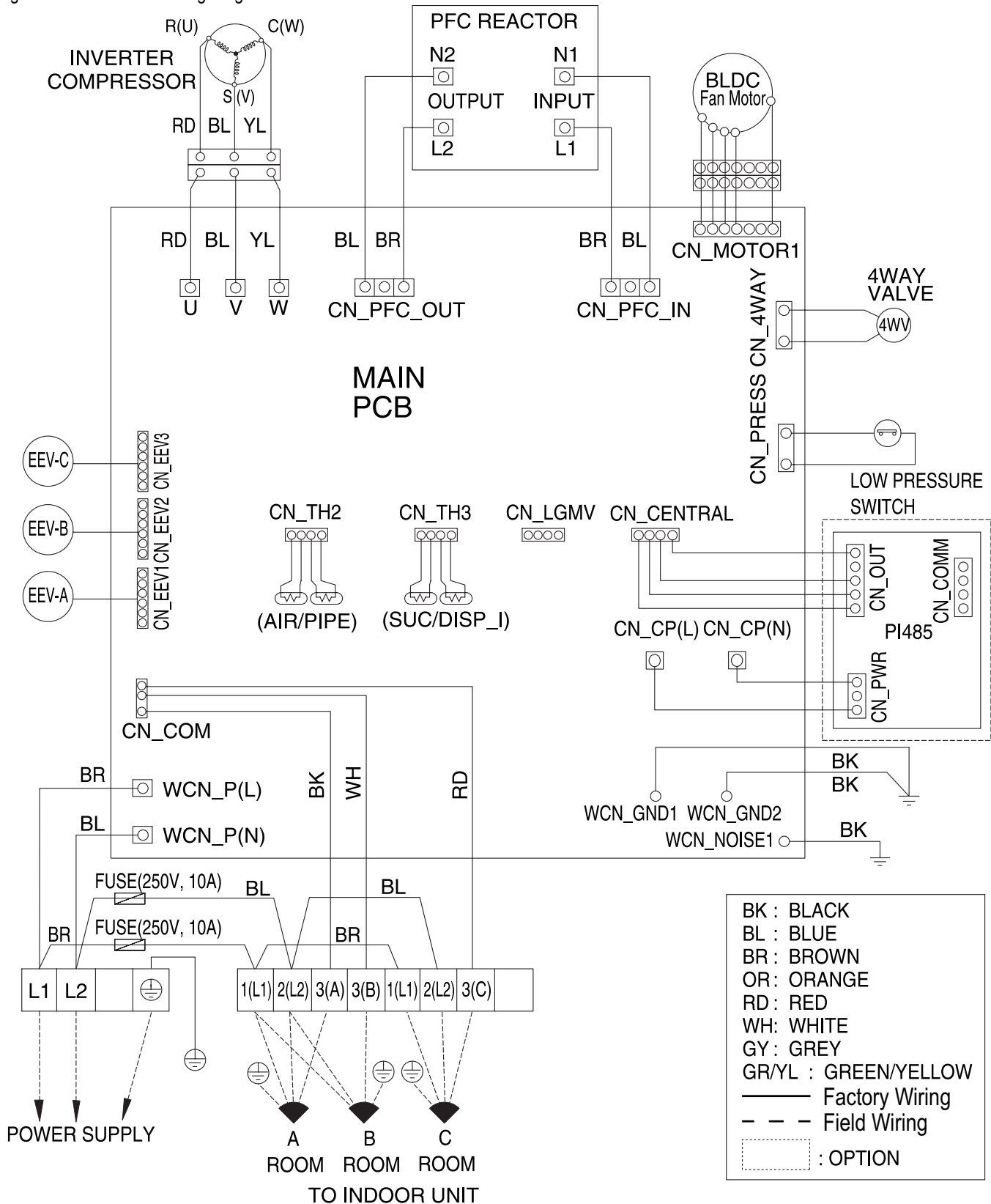

# MULTI F OUTDOOR UNIT

## Wiring Diagram

MULTI F  
MULTI F MAX

Figure 16: LMU369HV Wiring Diagram.

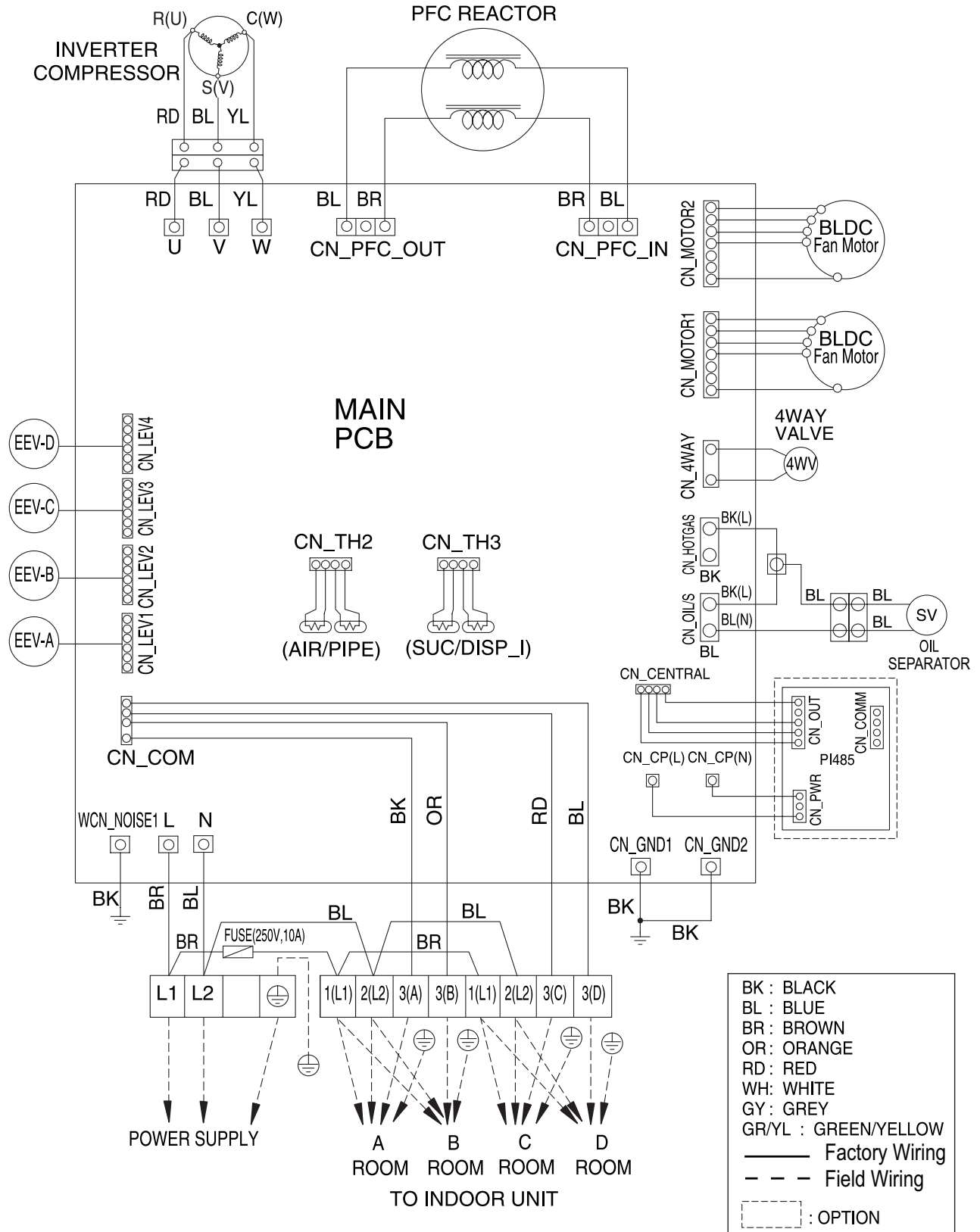
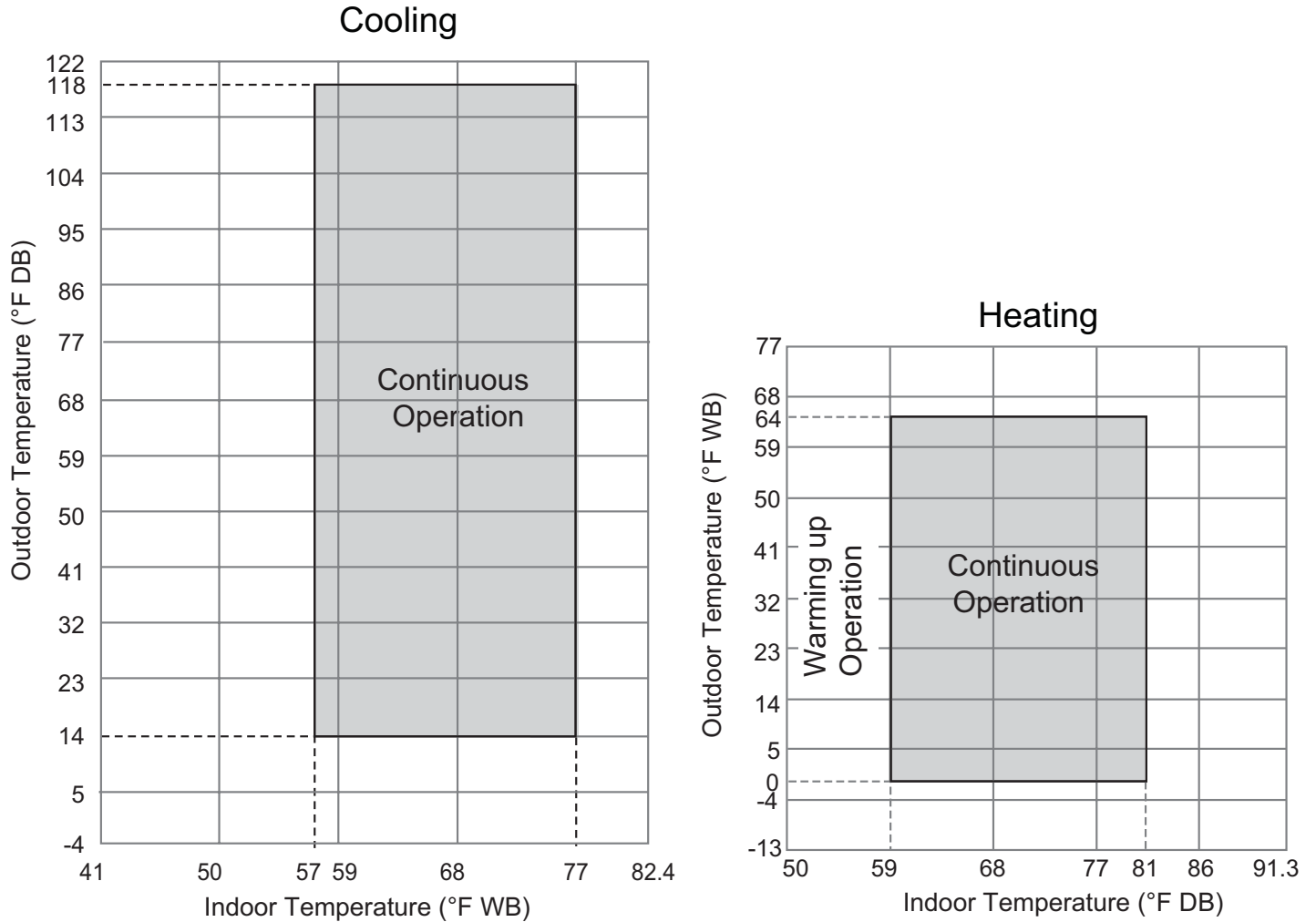

Figure 17: Cooling and Heating Operation Ranges.





# MULTI F MAX OUTDOOR UNIT DATA

**“Product Features and Benefits” on page 126**

**“Mechanical Specifications” on page 127**

**“General Data” on page 128**

**“Dimensions” on page 130**

**“Rated Cooling Combination Tables” on page 131**

**“Rated Heating Combination Tables” on page 134**

**“Cooling Capacity Tables ” on page 137**

**“Heating Capacity Tables” on page 154**

**“Electrical Data” on page 165**

**“Acoustic Data” on page 165**

**“Refrigerant Flow Diagrams” on page 166**

**“Wiring Diagrams” on page 167**

**“Operation Range” on page 168**

# MULTI F MAX OUTDOOR UNIT

MULTI F  
MULTI F MAX

## Features and Benefits

Multi F MAX inverter-driven heat pump systems can operate up to eight indoor units, providing cooling or heating for an entire home and zoning capabilities. Compact refrigerant pipes work in tandem with wiring to link the outdoor unit with all indoor units through a single or pair of branch distribution (BD) unit(s). Most indoor units include its own remote control, allowing the user to set the temperature individually in different rooms. The indoor units are available in a variety of capacities and styles, including Art Cool™ Mirror and Gallery Wall Mount, Standard Wall Mount, Four-Way Ceiling Cassette, Horizontal Ceiling Concealed Duct, and Vertical-Horizontal Air Handling models.

### Features

- Advanced climate control for up to eight (8) zones
- Inverter (Variable speed compressor)
- DC inverter technology – load matches to reduce power consumption
- Low ambient operation to 14°F (Cooling)
- Heating operation down to 0°F
- Defrost
- Restart delay (three [3] minutes)
- Self diagnosis
- Soft start
- Auto operation / auto restart operation
- Gold Fin™ anti-corrosion

### Benefits

- Refrigerant piping lengths allow for extra design flexibility in indoor unit installation
- Easy installation: Little to no ductwork required; most indoor units can mount on any wall
- Indoor unit and outdoor unit dimensions ensure space saving convenience
- All-season use—heat pump models have both cooling and heating capabilities

Figure 18: Multi F MAX Heat Pump Inverter System — Mix and match for 24,000-73,000 Btu/h.



## Multi F MAX Heat Pump Condensing Units

### General

A Multi F MAX multi-zone system is comprised of one heat pump outdoor unit connected up to eight indoor units through a branch distribution unit (BD) using a single refrigerant piping circuit, and includes integrated controls supplied by LG. Factory-designed and supplied Y-branches may be used as well.

The outdoor unit is internally assembled, wired, and piped from the factory; all LG components are manufactured in a facility registered to ISO 9001 and ISO 14001, set by the International Organization for Standardization (ISO). The LG Multi F MAX multi zone heat pump system components comply with Underwriters Laboratories (UL) 1995 Heating and Cooling Equipment Standard for Safety, and bear the Electrical Testing Laboratories (ETL) mark. The units are certified to AHRI 210 / 240.

### Temperature Ranges

The heat pump outdoor units are capable of operating in cooling mode from 14°F to 118°F ambient dry bulb. The heat pump outdoor units are capable of operating in heating mode from 0°F to 64°F ambient wet bulb without additional low ambient controls.

### Frame

Multi F MAX condensing unit case is constructed from pre-coated metal that has been tested in accordance with ASTM B-117 salt spray procedure for a minimum of 1,000 hours. Case has a removable front panel to allow access to major components and control devices, and legs to secure the unit during installation.

### Refrigerant System

Multi F MAX systems have a single refrigerant circuit field piped with a manufacturer-supplied BD unit(s) and Y-branches (if applicable) to multiple (ducted, non-ducted or mixed) indoor units to effectively and efficiently control the heating or cooling operation of the multi zone system. All refrigerant lines from the outdoor unit to the BD unit(s) and from the BD unit(s) to indoor units are field-installed and must be insulated separately.

Multi F MAX systems use R410A refrigerant. The outdoor units are equipped with a refrigerant strainer, check valves, oil separator, accumulator, four-way reversing valve, electronic expansion valve(s) (EEV), high side and low side refrigerant charging ports, and a service port. The outdoor unit also includes sensors for suction temperature, discharge temperature, high-pressure, low-pressure, heat exchanger temperature, and outdoor temperature conditions.

### Refrigeration Oil Control

The outdoor unit has an oil separator to separate oil mixed with the refrigerant gas during compression and return oil to the compressor. The outdoor unit also has an oil injection mechanism to ensure a consistent film of oil on all moving compressor parts at low speed.

### Compressor

Multi F condensing units are equipped with one hermetically sealed, digitally controlled, inverter driven twin-rotary compressor that

Figure 19: Multi F MAX LMU540HV Outdoor Unit.



includes Teflon™ coated bearings. The inverter motor is capable of providing a modulation range of 20Hz to 100Hz with control in 1Hz increments. The compressor is protected with phase-reversal protection, uses a factory-charge of Polyvinyl Ether (PVE) oil, and is mounted to avoid the transmission of vibration. Compressor in the Multi F MAX outdoor unit is equipped with a hot gas bypass valve.

### Fan and Motors

The Multi F MAX outdoor unit includes two direct drive variable speed propeller fans with Brushless Digitally Controlled (BLDC) motor with a horizontal air discharge.

Fan blades are statically and dynamically balanced propeller fans made of durable Acrylonitrile Butadiene Styrene (ABS) plastic, and include a raised fan guard to limit contact with moving parts. The motors have inherent overload protection, permanently lubricated bearings, and a maximum speed up to 950 rpm. Multi F MAX outdoor unit has a horizontal discharge airflow.

### Outdoor Unit Coil

The outdoor unit coils are factory-built of aluminum fins mechanically bonded on copper tubing. Coils have a minimum of two rows, a minimum of 14 fins per inch, and have been factory pressure-tested.

Coil fins also have a factory applied corrosion-resistant GoldFin™ material with hydrophilic coating that has been tested in accordance with ASTM B-117 salt spray test procedure for a minimum of 1,000 hours.

### Electrical

Multi F MAX outdoor unit shall be 208/230V, 1 phase, 60Hz electrical power capable of operating within ±10% of the rated voltage.

### Controls

Factory installed microprocessor controls in the outdoor unit, BD unit(s), and indoor units shall perform functions to efficiently operate the multi zone system. System wiring must be installed in a tree configuration from outdoor unit to BD unit(s) to indoor units through four conductor power/transmission cable. The system is capable of performing continuous operation, even when power is turned off to an individual indoor unit.

# MULTI F MAX OUTDOOR UNIT

MULTI F  
MULTI F MAX

## General Data

Table 115: Multi F MAX Outdoor Unit General Data.

Model Number	LMU540HV
Rated Cooling Capacity (Btu/h) <sup>1</sup>	52,500
Rated Heating Capacity (Btu/h) <sup>1</sup>	58,000
<b>Operating Range</b>	
Cooling (°F DB)	14 - 118
Heating (°F WB)	0 - 64
<b>Compressor</b>	
Inverter Quantity	Twin Rotary x 1
Oil/Type	FVC68D
<b>Fan (Side Discharge)</b>	
Type	Propeller
Motor Output (W) x Qty.	124.2 x 2
Motor/Drive	Brushless Digitally Controlled/Direct
Maximum Air Volume (CFM)	2,119 x 2
<b>Unit Data</b>	
Refrigerant Type	R410A
Refrigerant Control/Location	EEV / Outdoor Unit, Branch Distribution Unit
Min. Number Indoor Units/System <sup>2</sup>	2
Max. Number Indoor Units/System <sup>2</sup>	8
Maximum Allowable Total Indoor Unit Connected Capacity (Btu/h)	73,000
Sound Pressure $\pm 3$ dB(A) <sup>3</sup> (Cooling / Heating)	54 / 56
Net Unit Weight (lbs.)	213.8
Shipping Weight (lbs.)	236
Power Wiring / Communication Cables <sup>4</sup> (No. x AWG)	4 x 16
<b>Heat Exchanger</b>	
Material and Fin Coating	Copper Tube / Aluminum Fin and GoldFin™/Hydrophilic
Rows/Columns/Fins per inch x Qty.	(2 x 32 x 14) x 2
<b>Piping</b>	
Liquid Line Connection (in., OD) x Qty.	3/8 x 1
Vapor Line Connection (in., OD) x Qty.	3/4 x 1
Factory Charge lbs. of R410A	9.7
<b>Piping Lengths</b>	
Maximum Total System Piping (ft.) <sup>5</sup>	476
Maximum Main Pipe Length (Outdoor Unit to Branch Distribution Unit [ft.])	180
Total Branch Piping (Branch Distribution Units to all Indoor Units [ft.])	295
Maximum Branch Pipe Length (Length between each BDU and IDU [ft.])	49
Maximum Outdoor Unit to Indoor Unit Pipe Length (ft.)	230
Piping Length (No Additional Refrigerant [ft.]; 16 ft. of Main Piping + 131 ft. of Branch Piping)	147
Maximum Elevation between Outdoor Unit and Indoor Unit (ft.)	98
Maximum Elevation between Indoor Unit and Indoor Unit (ft.)	49
Maximum Elevation between Branch Distribution Unit and Indoor Unit (ft.)	33
Maximum Elevation between Branch Distribution Unit and Branch Distribution Unit (ft.)	49

<sup>1</sup>Rated capacity applied with non-ducted indoor units, and is rated 0 ft. above sea level with a 0 ft. level difference between outdoor and indoor units. All capacities are net with a combination ratio between 95 – 105%.

Rated cooling capacity obtained with air entering the indoor unit at 80°F dry bulb (DB) and 67°F wet bulb (WB) and outdoor ambient conditions of 95°F dry bulb (DB) and 75°F wet bulb (WB).  
Rated heating capacity obtained with air entering the indoor unit at 70°F dry bulb (DB) and 60°F wet bulb (WB) and outdoor ambient conditions of 47°F dry bulb (DB) and 43°F wet bulb (WB).

<sup>2</sup>At least one Branch Distribution Unit is required for system operation; a maximum of two can be installed per outdoor unit with use of Y-branch accessory (PMBL5620). At least two indoor units should

be connected. For allocated capacity information, see the combination tables on pages 131 to 136.

<sup>3</sup>Sound pressure levels are tested in an anechoic chamber under ISO Standard 3745. These values can increase due to ambient conditions during operation.

<sup>4</sup>All power wiring / communication cable to be minimum 16 AWG from the outdoor unit to the BD unit, and 18 AWG from the BD unit to the indoor unit, stranded, shielded, and must comply with applicable local and national codes. For detailed electrical information, please refer to electric characteristics on page 165.

<sup>5</sup>Piping lengths are equivalent.

Table 116: LMU540HV Efficiency Ratings.<sup>1,2</sup>

System	Combined With	Rated Cooling Capacity (Btu/h)	EER (95°F)	SEER	Rated Heating Capacity (Btu/h)	COP (47°F)	HSPF	Low Heating Capacity (Btu/h)	COP (17°F)	Energy Star
LMU540HV	Non-ducted Indoor Units	52,500	10.3	18.4	58,000	3.1	8.7	36,600	2.6	Yes
	Ducted Indoor Units	51,000	10.0	15.8	58,000	3.0	8.0	38,500	2.6	No
	Mixed Non-ducted and Ducted Indoor Units	51,750	10.15	17.1	58,000	3.0	8.35	37,550	2.6	No

<sup>1</sup>Rated capacity is rated 0 ft. above sea level with Piping Length as Main pipe (16.4 ft.) + Branch pipe (98.4 ft.) = 115 ft., and a 0 ft. level difference between outdoor and indoor units. All capacities are net with a combination ratio between 95 – 105%.

Rated cooling capacity rating obtained with air entering the indoor unit at 80°F dry bulb (DB) and 67°F wet bulb (WB) and outdoor ambient conditions of 95°F dry bulb (DB) and 75°F wet bulb (WB).

Rated heating capacity rating obtained with air entering the indoor unit at 70°F dry bulb (DB) and 60°F wet bulb (WB) and outdoor ambient conditions of 47°F dry bulb (DB) and 43°F wet bulb (WB).

<sup>2</sup>Rated capacity is certified under AHRI Standard 210 / 240. EER, IEER, COP, and HSPF are subject to change. See [www.ahrinet.org](http://www.ahrinet.org) for the latest values.

# MULTI F MAX OUTDOOR UNIT

## Dimensions

MULTI F  
MULTI F MAX

Figure 20: LMU540HV External Dimensions.

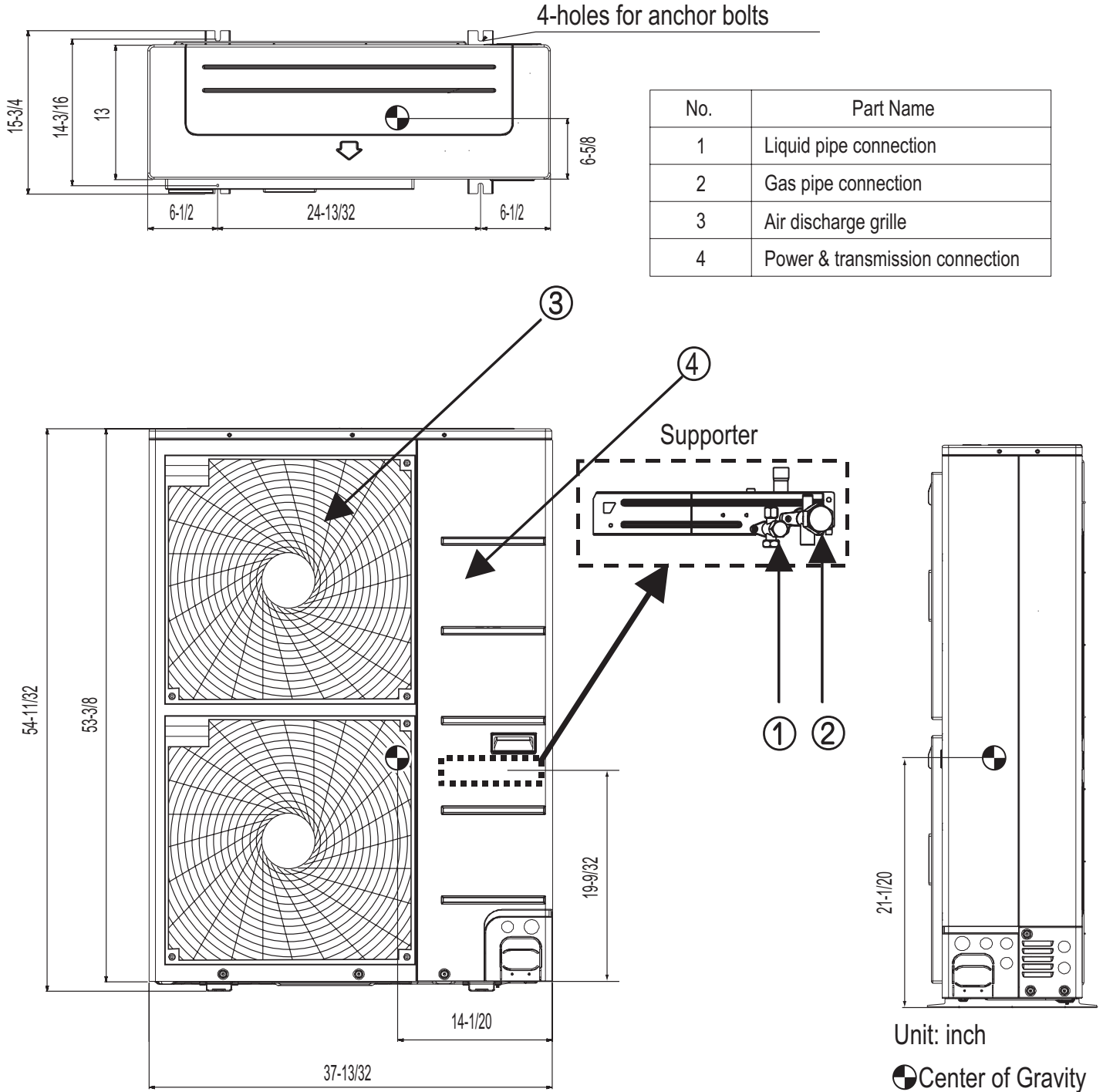

The individual indoor unit capacity can be calculated based on the outdoor unit Rated capacity as follows.<sup>1</sup>

$$\text{Individual Indoor Unit Combination Capacity (Qidu [Combi])} = \frac{\text{Outdoor Unit Rated Capacity (Qodu [Rated])} \times \text{Individual Indoor Unit Rated Capacity (Qidu [Rated])}{\text{Total Connected Indoor Unit Rated Capacity } (\sum \text{Qidu [Rated]})}$$

<sup>1</sup>To calculate the individual IDU capacity based on ODU Corrected capacity, replace (Qodu [Rated]) with (Qodu [Corrected]) where (Qodu [Corrected]) is obtained from the capacity tables referencing design conditions.

Table 117: LMU540HV with Non-Ducted Indoor Units — Rated Cooling Combination Table.

Total Indoor Unit Capacity (kBtu/h)	Cooling Capacity						Input (W)			EER	SEER
	Minimum		Rated		Maximum		Minimum	Rated	Maximum		
	Btu/h	kW	Btu/h	kW	Btu/h	kW					
24	14,000	4.10	23,333	6.84	25,813	7.57	1,000	1,550	2,336	15.10	19.6
25	14,583	4.27	24,306	7.12	26,889	7.88	1,168	1,668	2,433	14.60	19.5
26	15,167	4.45	25,278	7.41	27,964	8.20	1,251	1,786	2,530	14.10	19.5
27	15,750	4.62	26,250	7.69	29,040	8.51	1,333	1,905	2,628	13.80	19.4
28	16,333	4.79	27,222	7.98	30,116	8.83	1,517	2,023	2,725	13.50	19.4
29	16,917	4.96	28,194	8.26	31,191	9.14	1,606	2,141	2,822	13.20	19.4
30	17,500	5.13	29,167	8.55	32,267	9.46	1,695	2,259	2,919	12.90	19.3
31	18,083	5.30	30,139	8.83	33,342	9.77	1,855	2,378	3,017	12.70	19.3
32	18,667	5.47	31,111	9.12	34,418	10.09	1,947	2,496	3,114	12.50	19.3
33	19,250	5.64	32,083	9.40	35,493	10.40	2,039	2,614	3,211	12.30	19.2
34	19,833	5.81	33,056	9.69	36,569	10.72	2,131	2,732	3,309	12.10	19.2
35	20,417	5.98	34,028	9.97	37,644	11.03	2,280	2,851	3,406	11.90	19.1
36	21,000	6.15	35,000	10.26	38,720	11.35	2,375	2,969	3,503	11.80	19.1
37	21,583	6.33	35,972	10.54	39,796	11.66	2,470	3,087	3,601	11.70	19.1
38	22,167	6.50	36,944	10.83	40,871	11.98	2,564	3,205	3,698	11.50	19.0
39	22,750	6.67	37,917	11.11	41,947	12.29	2,659	3,324	3,795	11.40	19.0
40	23,333	6.84	38,889	11.40	43,022	12.61	2,753	3,442	3,893	11.30	18.9
41	23,917	7.01	39,861	11.68	44,098	12.92	2,848	3,560	3,990	11.20	18.9
42	24,500	7.18	40,833	11.97	45,173	13.24	2,943	3,678	4,087	11.10	18.9
43	25,083	7.35	41,806	12.25	46,249	13.55	3,037	3,796	4,185	11.00	18.8
44	25,667	7.52	42,778	12.54	47,324	13.87	3,132	3,915	4,282	10.90	18.8
45	26,250	7.69	43,750	12.82	48,400	14.19	3,226	4,033	4,379	10.80	18.7
46	26,833	7.86	44,722	13.11	49,476	14.50	3,321	4,151	4,476	10.80	18.7
47	27,417	8.04	45,694	13.39	50,551	14.82	3,415	4,269	4,574	10.70	18.7
48	28,000	8.21	46,667	13.68	51,627	15.13	3,510	4,388	4,671	10.60	18.6
49	28,583	8.38	47,639	13.96	52,702	15.45	3,605	4,506	4,768	10.60	18.6
50	29,167	8.55	48,611	14.25	53,778	15.76	3,699	4,624	4,866	10.50	18.6
51	29,750	8.72	49,583	14.53	54,853	16.08	3,794	4,742	4,963	10.50	18.5
52	30,333	8.89	50,556	14.82	55,929	16.39	3,888	4,861	5,060	10.40	18.5
53	30,917	9.06	51,528	15.10	57,004	16.71	3,983	4,979	5,158	10.30	18.4
54	31,500	9.23	52,500	15.39	58,080	17.02	4,078	5,097	5,255	10.30	18.4
55	31,892	9.35	52,666	15.44	58,349	17.10	4,102	5,128	5,287	10.30	18.3
56	32,285	9.46	52,832	15.48	58,619	17.18	4,127	5,159	5,319	10.20	18.2
57	32,677	9.58	52,997	15.53	58,888	17.26	4,152	5,190	5,351	10.20	18.1
58	33,069	9.69	53,163	15.58	59,158	17.34	4,176	5,221	5,382	10.20	18.0
59	33,462	9.81	53,329	15.63	59,427	17.42	4,201	5,252	5,414	10.20	17.9
60	33,854	9.92	53,495	15.68	59,697	17.50	4,226	5,282	5,446	10.10	17.8
61	34,247	10.04	53,661	15.73	59,966	17.58	4,251	5,313	5,478	10.10	17.7
62	34,639	10.15	53,826	15.78	60,236	17.65	4,275	5,344	5,510	10.10	17.6
63	35,031	10.27	53,992	15.82	60,505	17.73	4,300	5,375	5,542	10.00	17.5
64	35,424	10.38	54,158	15.87	60,775	17.81	4,325	5,406	5,573	10.00	17.4
65	35,816	10.50	54,324	15.92	61,044	17.89	4,350	5,437	5,605	10.00	17.3
66	36,208	10.61	54,489	15.97	61,314	17.97	4,374	5,468	5,637	10.00	17.2
67	36,601	10.73	54,655	16.02	61,583	18.05	4,399	5,499	5,669	9.90	17.1
68	36,993	10.84	54,821	16.07	61,853	18.13	4,424	5,530	5,701	9.90	17.0
69	37,386	10.96	54,987	16.12	62,122	18.21	4,448	5,561	5,733	9.90	16.9
70	37,778	11.07	55,153	16.16	62,392	18.29	4,473	5,591	5,764	9.90	16.9
71	38,170	11.19	55,318	16.21	62,661	18.36	4,498	5,622	5,796	9.80	16.8
72	38,563	11.30	55,484	16.26	62,931	18.44	4,523	5,653	5,828	9.80	16.7
73	38,955	11.42	55,650	16.31	63,200	18.52	4,547	5,684	5,860	9.80	16.6

<sup>1</sup>Capacity as rated: 0 ft. above sea level with Piping Length as Main Pipe (16.4 ft.) + Branch pipe (98.4 ft.) = 115 ft.  
0 ft. level difference between outdoor and indoor units.

<sup>2</sup>Cooling capacity rating obtained with air entering the indoor unit at 80°F dry bulb (DB) and 67°F wet bulb (WB), and outdoor ambient conditions of 95°F dry bulb (DB) and 75°F wet bulb (WB).

<sup>3</sup>Wiring cable size must comply with the applicable local and national codes.

<sup>4</sup>The specification may be subject to change without prior notice for purpose of improvement.

<sup>5</sup>Sum of connected indoor units capacity is 24~73 kBtu/h.

<sup>6</sup>At least two indoor units should be connected.



# PERFORMANCE DATA

## Rated Cooling Combination Tables

**MULTI F**  
**MULTI F MAX**

Table 118: LMU540HV with Ducted Indoor Units — Rated Cooling Combination Table.

Total Indoor Unit Capacity (kBtu/h)	Cooling Capacity						Input (W)			EER	SEER
	Minimum		Rated		Maximum		Minimum	Rated	Maximum		
	Btu/h	kW	Btu/h	kW	Btu/h	kW					
24	13,600	3.99	22,667	6.64	25,076	7.35	1,000	1,550	2,337	14.60	18.3
25	14,167	4.15	23,611	6.92	26,121	7.66	1,168	1,668	2,434	14.20	18.1
26	14,733	4.32	24,556	7.20	27,165	7.96	1,251	1,787	2,532	13.70	18.1
27	15,300	4.48	25,500	7.47	28,210	8.27	1,334	1,905	2,629	13.40	18.0
28	15,867	4.65	26,444	7.75	29,255	8.57	1,518	2,023	2,726	13.10	17.9
29	16,433	4.82	27,389	8.03	30,300	8.88	1,606	2,142	2,824	12.80	17.8
30	17,000	4.98	28,333	8.30	31,345	9.19	1,695	2,260	2,921	12.50	17.7
31	17,567	5.15	29,278	8.58	32,390	9.49	1,855	2,378	3,019	12.30	17.7
32	18,133	5.31	30,222	8.86	33,434	9.80	1,947	2,497	3,116	12.10	17.6
33	18,700	5.48	31,167	9.13	34,479	10.11	2,040	2,615	3,213	11.90	17.5
34	19,267	5.65	32,111	9.41	35,524	10.41	2,132	2,733	3,311	11.70	17.4
35	19,833	5.81	33,056	9.69	36,569	10.72	2,281	2,852	3,408	11.60	17.3
36	20,400	5.98	34,000	9.96	37,614	11.02	2,376	2,970	3,505	11.40	17.3
37	20,967	6.14	34,944	10.24	38,659	11.33	2,471	3,088	3,603	11.30	17.2
38	21,533	6.31	35,889	10.52	39,703	11.64	2,565	3,207	3,700	11.20	17.1
39	22,100	6.48	36,833	10.80	40,748	11.94	2,660	3,325	3,798	11.10	17.0
40	22,667	6.64	37,778	11.07	41,793	12.25	2,755	3,443	3,895	11.00	16.9
41	23,233	6.81	38,722	11.35	42,838	12.56	2,849	3,562	3,992	10.90	16.8
42	23,800	6.98	39,667	11.63	43,883	12.86	2,944	3,680	4,090	10.80	16.8
43	24,367	7.14	40,611	11.90	44,927	13.17	3,039	3,798	4,187	10.70	16.7
44	24,933	7.31	41,556	12.18	45,972	13.47	3,133	3,917	4,284	10.60	16.6
45	25,500	7.47	42,500	12.46	47,017	13.78	3,228	4,035	4,382	10.50	16.5
46	26,067	7.64	43,444	12.73	48,062	14.09	3,323	4,153	4,479	10.50	16.4
47	26,633	7.81	44,389	13.01	49,107	14.39	3,417	4,272	4,576	10.40	16.4
48	27,200	7.97	45,333	13.29	50,152	14.70	3,512	4,390	4,674	10.30	16.3
49	27,767	8.14	46,278	13.56	51,196	15.00	3,607	4,508	4,771	10.30	16.2
50	28,333	8.30	47,222	13.84	52,241	15.31	3,701	4,627	4,869	10.20	16.1
51	28,900	8.47	48,167	14.12	53,286	15.62	3,796	4,745	4,966	10.20	16.0
52	29,467	8.64	49,111	14.39	54,331	15.92	3,891	4,863	5,063	10.10	16.0
53	30,033	8.80	50,056	14.67	55,376	16.23	3,985	4,982	5,161	10.00	15.9
54	30,600	8.97	51,000	14.95	56,421	16.54	4,080	5,100	5,258	10.00	15.8
55	30,981	9.08	51,161	14.99	56,777	16.64	4,105	5,131	5,290	10.00	15.8
56	31,362	9.19	51,322	15.04	57,134	16.75	4,129	5,161	5,321	9.90	15.8
57	31,743	9.30	51,483	15.09	57,491	16.85	4,154	5,192	5,353	9.90	15.8
58	32,125	9.42	51,644	15.14	57,848	16.95	4,178	5,223	5,385	9.90	15.8
59	32,506	9.53	51,805	15.18	58,205	17.06	4,203	5,254	5,416	9.90	15.8
60	32,887	9.64	51,966	15.23	58,561	17.16	4,228	5,284	5,448	9.80	15.8
61	33,268	9.75	52,127	15.28	58,918	17.27	4,252	5,315	5,480	9.80	15.8
62	33,649	9.86	52,288	15.32	59,275	17.37	4,277	5,346	5,512	9.80	15.8
63	34,030	9.97	52,449	15.37	59,632	17.48	4,301	5,377	5,543	9.80	15.8
64	34,412	10.09	52,611	15.42	59,989	17.58	4,326	5,407	5,575	9.70	15.8
65	34,793	10.20	52,772	15.47	60,346	17.69	4,351	5,438	5,607	9.70	15.8
66	35,174	10.31	52,933	15.51	60,702	17.79	4,375	5,469	5,638	9.70	15.8
67	35,555	10.42	53,094	15.56	61,059	17.90	4,400	5,500	5,670	9.70	15.8
68	35,936	10.53	53,255	15.61	61,416	18.00	4,424	5,530	5,702	9.60	15.8
69	36,317	10.64	53,416	15.66	61,773	18.10	4,449	5,561	5,733	9.60	15.8
70	36,699	10.76	53,577	15.70	62,130	18.21	4,474	5,592	5,765	9.60	15.8
71	37,080	10.87	53,738	15.75	62,486	18.31	4,498	5,623	5,797	9.60	15.8
72	37,461	10.98	53,899	15.80	62,843	18.42	4,523	5,653	5,828	9.50	15.8
73	37,842	11.09	54,060	15.84	63,200	18.52	4,547	5,684	5,860	9.50	15.8

<sup>1</sup>Capacity as rated: 0 ft. above sea level with Piping Length as Main Pipe (16.4 ft.) + Branch pipe (98.4 ft.) = 115 ft.  
0 ft. level difference between outdoor and indoor units.

<sup>2</sup>Cooling capacity rating obtained with air entering the indoor unit at 80°F dry bulb (DB) and 67°F wet bulb (WB), and outdoor ambient conditions of 95°F dry bulb (DB) and 75°F wet bulb (WB).

<sup>3</sup>Wiring cable size must comply with the applicable local and national codes.

<sup>4</sup>The specification may be subject to change without prior notice for purpose of improvement.

<sup>5</sup>Sum of connected indoor units capacity is 24-73 kBtu/h.

<sup>6</sup>At least two indoor units should be connected.



Multi F and Multi F MAX Heat Pump System Engineering Manual

Table 119: LMU540HV with Mixed Indoor Units — Rated Cooling Combination Table.

Total Indoor Unit Capacity (kBtu/h)	Cooling Capacity						Input (W)			EER	SEER
	Minimum		Rated		Maximum		Minimum	Rated	Maximum		
	Btu/h	kW	Btu/h	kW	Btu/h	kW					
24	13,800	4.04	23,000	6.74	25,445	7.46	1,000	1,550	2,336	14.85	19.0
25	14,375	4.21	23,958	7.02	26,505	7.77	1,168	1,668	2,434	14.40	18.8
26	14,950	4.38	24,917	7.30	27,565	8.08	1,251	1,787	2,531	13.90	18.8
27	15,525	4.55	25,875	7.58	28,625	8.39	1,333	1,905	2,628	13.60	18.7
28	16,100	4.72	26,833	7.86	29,685	8.70	1,517	2,023	2,726	13.30	18.7
29	16,675	4.89	27,792	8.15	30,746	9.01	1,606	2,141	2,823	13.00	18.6
30	17,250	5.06	28,750	8.43	31,806	9.32	1,695	2,260	2,920	12.70	18.5
31	17,825	5.22	29,708	8.71	32,866	9.63	1,855	2,378	3,018	12.50	18.5
32	18,400	5.39	30,667	8.99	33,926	9.94	1,947	2,496	3,115	12.30	18.4
33	18,975	5.56	31,625	9.27	34,986	10.25	2,039	2,615	3,212	12.10	18.4
34	19,550	5.73	32,583	9.55	36,046	10.56	2,132	2,733	3,310	11.90	18.3
35	20,125	5.90	33,542	9.83	37,107	10.88	2,281	2,851	3,407	11.75	18.2
36	20,700	6.07	34,500	10.11	38,167	11.19	2,376	2,969	3,504	11.60	18.2
37	21,275	6.24	35,458	10.39	39,227	11.50	2,470	3,088	3,602	11.50	18.1
38	21,850	6.40	36,417	10.67	40,287	11.81	2,565	3,206	3,699	11.35	18.1
39	22,425	6.57	37,375	10.95	41,347	12.12	2,659	3,324	3,796	11.25	18.0
40	23,000	6.74	38,333	11.23	42,408	12.43	2,754	3,443	3,894	11.15	17.9
41	23,575	6.91	39,292	11.52	43,468	12.74	2,849	3,561	3,991	11.05	17.9
42	24,150	7.08	40,250	11.80	44,528	13.05	2,943	3,679	4,088	10.95	17.8
43	24,725	7.25	41,208	12.08	45,588	13.36	3,038	3,797	4,186	10.85	17.8
44	25,300	7.42	42,167	12.36	46,648	13.67	3,133	3,916	4,283	10.75	17.7
45	25,875	7.58	43,125	12.64	47,709	13.98	3,227	4,034	4,380	10.65	17.6
46	26,450	7.75	44,083	12.92	48,769	14.29	3,322	4,152	4,478	10.65	17.6
47	27,025	7.92	45,042	13.20	49,829	14.60	3,416	4,271	4,575	10.55	17.5
48	27,600	8.09	46,000	13.48	50,889	14.91	3,511	4,389	4,672	10.45	17.5
49	28,175	8.26	46,958	13.76	51,949	15.23	3,606	4,507	4,770	10.45	17.4
50	28,750	8.43	47,917	14.04	53,010	15.54	3,700	4,625	4,867	10.35	17.3
51	29,325	8.59	48,875	14.32	54,070	15.85	3,795	4,744	4,965	10.35	17.3
52	29,900	8.76	49,833	14.61	55,130	16.16	3,890	4,862	5,062	10.25	17.2
53	30,475	8.93	50,792	14.89	56,190	16.47	3,984	4,980	5,159	10.15	17.2
54	31,050	9.10	51,750	15.17	57,250	16.78	4,079	5,099	5,257	10.15	17.1
55	31,625	9.27	52,708	15.45	58,310	17.09	4,173	5,217	5,354	10.15	17.1
56	32,200	9.44	53,667	15.73	59,370	17.40	4,267	5,335	5,451	10.05	17.0
57	32,775	9.61	54,625	16.01	60,430	17.71	4,361	5,456	5,548	10.05	17.0
58	33,350	9.78	55,583	16.29	61,490	18.02	4,455	5,577	5,645	10.05	16.9
59	33,925	9.95	56,542	16.57	62,550	18.33	4,549	5,698	5,742	10.05	16.9
60	34,500	10.12	57,500	16.85	63,610	18.64	4,643	5,819	5,839	9.95	16.8
61	35,075	10.29	58,458	17.13	64,670	18.95	4,737	5,940	5,936	9.95	16.8
62	35,650	10.46	59,417	17.41	65,730	19.26	4,831	6,061	6,033	9.95	16.7
63	36,225	10.63	60,375	17.69	66,790	19.57	4,925	6,182	6,130	9.95	16.7
64	36,800	10.80	61,333	17.97	67,850	19.88	5,019	6,303	6,227	9.85	16.6
65	37,375	10.97	62,292	18.25	68,910	20.19	5,113	6,424	6,324	9.85	16.6
66	37,950	11.14	63,250	18.53	69,970	20.50	5,207	6,545	6,421	9.85	16.5
67	38,525	11.31	64,208	18.81	71,030	20.81	5,301	6,666	6,518	9.85	16.5
68	39,100	11.48	65,167	19.09	72,090	21.12	5,395	6,787	6,615	9.85	16.4
69	39,675	11.65	66,125	19.37	73,150	21.43	5,489	6,908	6,712	9.75	16.4
70	40,250	11.82	67,083	19.65	74,210	21.74	5,583	7,029	6,809	9.75	16.4
71	40,825	12.00	68,042	19.93	75,270	22.05	5,677	7,150	6,906	9.75	16.3
72	41,400	12.17	69,000	20.21	76,330	22.36	5,771	7,271	7,003	9.75	16.3
73	41,975	12.34	69,958	20.49	77,390	22.67	5,865	7,392	7,100	9.65	16.2

Multi F MAX Outdoor Unit Data

<sup>1</sup>Capacity as rated: 0 ft. above sea level with Piping Length as Main Pipe (16.4 ft.) + Branch pipe (98.4 ft.) = 115 ft.  
0 ft. level difference between outdoor and indoor units.

<sup>2</sup>Cooling capacity rating obtained with air entering the indoor unit at 80°F dry bulb (DB) and 67°F wet bulb (WB), and outdoor ambient conditions of 95°F dry bulb (DB) and 75°F wet bulb (WB).

<sup>3</sup>Wiring cable size must comply with the applicable local and national codes.

<sup>4</sup>The specification may be subject to change without prior notice for purpose of improvement.

<sup>5</sup>Sum of connected indoor units capacity is 24-73 kBtu/h.

<sup>6</sup>At least two indoor units should be connected.

# PERFORMANCE DATA

## Rated Heating Combination Tables

**MULTI F**  
**MULTI F MAX**

Table 120: LMU540HV with Non-Ducted Indoor Units — Rated Heating Combination Table.

Total Indoor Unit Capacity (kBtu/h)	Heating Capacity						Input (W)			COP	HSPF
	Minimum		Rated		Maximum		Minimum	Rated	Maximum		
	Btu/h	kW	Btu/h	kW	Btu/h	kW					
24	15,467	4.53	25,778	7.56	27,067	7.93	1,490	2,161	2,474	3.50	10.3
25	16,111	4.72	26,852	7.87	28,194	8.26	1,588	2,268	2,578	3.50	10.2
26	16,756	4.91	27,926	8.18	29,322	8.59	1,664	2,376	2,681	3.40	10.1
27	17,400	5.10	29,000	8.50	30,450	8.92	1,739	2,484	2,784	3.40	10.1
28	18,044	5.29	30,074	8.81	31,578	9.25	1,944	2,592	2,887	3.40	10.0
29	18,689	5.48	31,148	9.13	32,706	9.59	2,025	2,700	2,990	3.40	10.0
30	19,333	5.67	32,222	9.44	33,833	9.92	2,106	2,808	3,093	3.40	9.9
31	19,978	5.86	33,296	9.76	34,961	10.25	2,275	3,2916	3,196	3.30	9.9
32	20,622	6.04	34,370	10.07	36,089	10.58	2,359	3,024	3,299	3.30	9.8
33	21,267	6.23	35,444	10.39	37,217	10.91	2,443	3,132	3,402	3.30	9.8
34	21,911	6.42	36,519	10.70	38,344	11.24	2,527	3,240	3,505	3.30	9.7
35	22,556	6.61	37,593	11.02	39,472	11.57	2,679	3,348	3,609	3.30	9.7
36	23,200	6.80	38,667	11.33	40,600	11.90	2,765	3,456	3,712	3.30	9.6
37	23,844	6.99	39,741	11.65	41,728	12.23	2,851	3,564	3,815	3.30	9.6
38	24,489	7.18	40,815	11.96	42,856	12.56	2,938	3,672	3,918	3.30	9.5
39	25,133	7.37	41,889	12.28	43,983	12.89	3,024	3,780	4,021	3.20	9.5
40	25,778	7.56	42,963	12.59	45,111	13.22	3,111	3,888	4,124	3.20	9.4
41	26,422	7.74	44,037	12.91	46,239	13.55	3,197	3,996	4,227	3.20	9.4
42	27,067	7.93	45,111	13.22	47,367	13.88	3,283	4,104	4,330	3.20	9.3
43	27,711	8.12	46,185	13.54	48,494	14.21	3,370	4,212	4,433	3.20	9.3
44	28,356	8.31	47,259	13.85	49,622	14.54	3,456	4,320	4,536	3.20	9.2
45	29,000	8.50	48,333	14.17	50,750	14.87	3,543	4,428	4,640	3.20	9.2
46	29,644	8.69	49,407	14.48	51,878	15.20	3,629	4,536	4,743	3.20	9.1
47	30,289	8.88	50,481	14.80	53,006	15.54	3,715	4,644	4,846	3.20	9.1
48	30,933	9.07	51,556	15.11	54,133	15.87	3,802	4,752	4,949	3.20	9.0
49	31,578	9.25	52,630	15.42	55,261	16.20	3,888	4,860	5,052	3.20	9.0
50	32,222	9.44	53,704	15.74	56,389	16.53	3,974	4,968	5,155	3.20	8.9
51	32,867	9.63	54,778	16.05	57,517	16.86	4,061	5,076	5,258	3.20	8.9
52	33,511	9.82	55,852	16.37	58,644	17.19	4,147	5,184	5,361	3.20	8.8
53	34,156	10.01	56,926	16.68	59,772	17.52	4,234	5,292	5,464	3.20	8.8
54	34,800	10.20	58,000	17.00	60,900	17.85	4,320	5,400	5,567	3.10	8.7
55	35,444	10.39	59,074	17.31	62,028	18.18	4,406	5,508	5,670	3.10	8.7
56	36,089	10.58	60,148	17.62	63,156	18.51	4,492	5,616	5,773	3.10	8.7
57	36,733	10.77	61,222	17.93	64,284	18.84	4,578	5,724	5,876	3.10	8.7
58	37,378	10.96	62,296	18.24	65,412	19.17	4,664	5,832	5,979	3.10	8.7
59	38,022	11.15	63,370	18.55	66,540	19.50	4,750	5,940	6,082	3.10	8.7
60	38,667	11.34	64,444	18.86	67,668	19.83	4,836	6,048	6,185	3.10	8.7
61	39,311	11.53	65,518	19.17	68,796	20.16	4,922	6,156	6,288	3.10	8.7
62	39,956	11.72	66,592	19.48	69,924	20.49	5,008	6,264	6,391	3.10	8.7
63	40,600	11.91	67,666	19.79	71,052	20.82	5,094	6,372	6,494	3.10	8.7
64	41,244	12.10	68,740	20.10	72,180	21.15	5,180	6,480	6,597	3.10	8.7
65	41,889	12.29	69,814	20.41	73,308	21.48	5,266	6,588	6,700	3.10	8.7
66	42,533	12.48	70,888	20.72	74,436	21.81	5,352	6,696	6,803	3.10	8.7
67	43,178	12.67	71,962	21.03	75,564	22.14	5,438	6,804	6,906	3.10	8.7
68	43,822	12.86	73,036	21.34	76,692	22.47	5,524	6,912	7,009	3.10	8.7
69	44,467	13.05	74,110	21.65	77,820	22.80	5,610	7,020	7,112	3.10	8.7
70	45,111	13.24	75,184	21.96	78,948	23.13	5,696	7,128	7,215	3.10	8.7
71	45,756	13.43	76,258	22.27	80,076	23.46	5,782	7,236	7,318	3.10	8.7
72	46,400	13.62	77,332	22.58	81,204	23.79	5,868	7,344	7,421	3.10	8.7
73	47,044	13.81	78,406	22.89	82,332	24.12	5,954	7,452	7,524	3.10	8.7

<sup>1</sup>Capacity as rated: 0 ft. above sea level with Piping Length as Main Pipe (16.4 ft.) + Branch pipe (98.4 ft.) = 115 ft.  
0 ft. level difference between outdoor and indoor units.

<sup>2</sup>Heating capacity rating obtained with air entering the indoor unit at 70°F dry bulb (DB) and 60°F wet bulb (WB), and outdoor ambient conditions of 47°F dry bulb (DB) and 43°F wet bulb (WB).

<sup>3</sup>Wiring cable size must comply with the applicable local and national codes.

<sup>4</sup>The specification may be subject to change without prior notice for purpose of improvement.

<sup>5</sup>Sum of connected indoor units capacity is 24-73 kBtu/h.

<sup>6</sup>At least two indoor units should be connected.



Multi F and Multi F MAX Heat Pump System Engineering Manual

Table 121: LMU540HV with Ducted Indoor Units — Rated Heating Combination Table.

Total Indoor Unit Capacity (kBtu/h)	Heating Capacity						Input (W)			COP	HSPF
	Minimum		Rated		Maximum		Minimum	Rated	Maximum		
	Btu/h	kW	Btu/h	kW	Btu/h	kW					
24	15,467	4.53	25,778	7.56	27,067	7.93	1,490	2,310	2,557	3.30	9.8
25	16,111	4.72	26,852	7.87	28,194	8.26	1,645	2,419	2,663	3.30	9.7
26	16,756	4.91	27,926	8.18	29,322	8.59	1,719	2,528	2,770	3.20	9.6
27	17,400	5.10	29,000	8.50	30,450	8.92	1,793	2,637	2,876	3.20	9.6
28	18,044	5.29	30,074	8.81	31,578	9.25	1,977	2,746	2,983	3.20	9.5
29	18,689	5.48	31,148	9.13	32,706	9.59	2,055	2,855	3,090	3.20	9.5
30	19,333	5.67	32,222	9.44	33,833	9.92	2,134	2,964	3,196	3.20	9.4
31	19,978	5.86	33,296	9.76	34,961	10.25	2,304	3,073	3,303	3.20	9.3
32	20,622	6.04	34,370	10.07	36,089	10.58	2,386	3,182	3,409	3.20	9.3
33	21,267	6.23	35,444	10.39	37,217	10.91	2,468	3,291	3,516	3.20	9.2
34	21,911	6.42	36,519	10.70	38,344	11.24	2,550	3,400	3,622	3.10	9.2
35	22,556	6.61	37,593	11.02	39,472	11.57	2,737	3,509	3,729	3.10	9.1
36	23,200	6.80	38,667	11.33	40,600	11.90	2,822	3,618	3,835	3.10	9.0
37	23,844	6.99	39,741	11.65	41,728	12.23	2,907	3,727	3,942	3.10	9.0
38	24,489	7.18	40,815	11.96	42,856	12.56	2,992	3,836	4,048	3.10	8.9
39	25,133	7.37	41,889	12.28	43,983	12.89	3,156	3,945	4,155	3.10	8.9
40	25,778	7.56	42,963	12.59	45,111	13.22	3,243	4,054	4,261	3.10	8.8
41	26,422	7.74	44,037	12.91	46,239	13.55	3,330	4,163	4,368	3.10	8.8
42	27,067	7.93	45,111	13.22	47,367	13.88	3,417	4,272	4,475	3.10	8.7
43	27,711	8.12	46,185	13.54	48,494	14.21	3,505	4,381	4,581	3.10	8.6
44	28,356	8.31	47,259	13.85	49,622	14.54	3,592	4,490	4,688	3.10	8.6
45	29,000	8.50	48,333	14.17	50,750	14.87	3,679	4,599	4,794	3.10	8.5
46	29,644	8.69	49,407	14.48	51,878	15.20	3,766	4,708	4,901	3.10	8.5
47	30,289	8.88	50,481	14.80	53,006	15.54	3,854	4,817	5,007	3.10	8.4
48	30,933	9.07	51,556	15.11	54,133	15.87	3,941	4,926	5,114	3.10	8.3
49	31,578	9.25	52,630	15.42	55,261	16.20	4,028	5,035	5,220	3.10	8.3
50	32,222	9.44	53,704	15.74	56,389	16.53	4,115	5,144	5,327	3.10	8.2
51	32,867	9.63	54,778	16.05	57,517	16.86	4,202	5,253	5,433	3.10	8.2
52	33,511	9.82	55,852	16.37	58,644	17.19	4,290	5,362	5,540	3.10	8.1
53	34,156	10.01	56,926	16.68	59,772	17.52	4,377	5,471	5,646	3.00	8.1
54	34,800	10.20	58,000	17.00	60,900	17.85	4,464	5,580	5,753	3.00	8.0
55	35,444	10.39	59,074	17.31	62,028	18.18	4,551	5,689	5,860	3.00	8.0
56	36,089	10.58	60,148	17.62	63,156	18.51	4,638	5,798	5,967	3.00	8.0
57	36,733	10.77	61,222	17.93	64,284	18.84	4,725	5,907	6,074	3.00	8.0
58	37,378	10.96	62,296	18.24	65,412	19.17	4,812	6,016	6,181	3.00	8.0
59	38,022	11.15	63,370	18.55	66,540	19.50	4,899	6,125	6,288	3.00	8.0
60	38,667	11.34	64,444	18.86	67,668	19.83	4,986	6,234	6,395	3.00	8.0
61	39,311	11.53	65,518	19.17	68,796	20.16	5,073	6,343	6,502	3.00	8.0
62	39,956	11.72	66,592	19.48	69,924	20.49	5,160	6,452	6,609	3.00	8.0
63	40,600	11.91	67,666	19.79	71,052	20.82	5,247	6,561	6,716	3.00	8.0
64	41,244	12.10	68,740	20.10	72,180	21.15	5,334	6,670	6,823	3.00	8.0
65	41,889	12.29	69,814	20.41	73,308	21.48	5,421	6,779	6,930	3.00	8.0
66	42,533	12.48	70,888	20.72	74,436	21.81	5,508	6,888	7,037	3.00	8.0
67	43,178	12.67	71,962	21.03	75,564	22.14	5,595	6,997	7,144	3.00	8.0
68	43,822	12.86	73,036	21.34	76,692	22.47	5,682	7,106	7,251	3.00	8.0
69	44,467	13.05	74,110	21.65	77,820	22.80	5,769	7,215	7,358	3.00	8.0
70	45,111	13.24	75,184	21.96	78,948	23.13	5,856	7,324	7,465	3.00	8.0
71	45,756	13.43	76,258	22.27	80,076	23.46	5,943	7,433	7,572	3.00	8.0
72	46,400	13.62	77,332	22.58	81,204	23.79	6,030	7,542	7,679	3.00	8.0
73	47,044	13.81	78,406	22.89	82,332	24.12	6,117	7,651	7,786	3.00	8.0

<sup>1</sup>Capacity as rated: 0 ft. above sea level with Piping Length as Main Pipe (16.4 ft.) + Branch pipe (98.4 ft.) = 115 ft.  
0 ft. level difference between outdoor and indoor units.

<sup>2</sup>Heating capacity rating obtained with air entering the indoor unit at 70°F dry bulb (DB) and 60°F wet bulb (WB), and outdoor ambient conditions of 47°F dry bulb (DB) and 43°F wet bulb (WB).

<sup>3</sup>Wiring cable size must comply with the applicable local and national codes.

<sup>4</sup>The specification may be subject to change without prior notice for purpose of improvement.

<sup>5</sup>Sum of connected indoor units capacity is 24-73 kBtu/h.

<sup>6</sup>At least two indoor units should be connected.

# PERFORMANCE DATA

## Rated Heating Combination Tables

**MULTI F**  
**MULTI F MAX**

Table 122: LMU540HV with Mixed Indoor Units — Rated Heating Combination Table.

Total Indoor Unit Capacity (kBtu/h)	Heating Capacity						Input (W)			COP	HSPF
	Minimum		Rated		Maximum		Minimum	Rated	Maximum		
	Btu/h	kW	Btu/h	kW	Btu/h	kW					
24	15,467	4.53	25,778	7.56	27,067	7.93	1,490	2,235	2,516	3.40	10.1
25	16,111	4.72	26,852	7.87	28,194	8.26	1,616	2,344	2,620	3.40	9.9
26	16,756	4.91	27,926	8.18	29,322	8.59	1,691	2,452	2,725	3.30	9.9
27	17,400	5.10	29,000	8.50	30,450	8.92	1,766	2,561	2,830	3.30	9.8
28	18,044	5.29	30,074	8.81	31,578	9.25	1,961	2,669	2,935	3.30	9.8
29	18,689	5.48	31,148	9.13	32,706	9.59	2,040	2,778	3,040	3.30	9.7
30	19,333	5.67	32,222	9.44	33,833	9.92	2,120	2,886	3,145	3.30	9.7
31	19,978	5.86	33,296	9.76	34,961	10.25	2,290	2,995	3,249	3.25	9.6
32	20,622	6.04	34,370	10.07	36,089	10.58	2,373	3,103	3,354	3.25	9.6
33	21,267	6.23	35,444	10.39	37,217	10.91	2,456	3,212	3,459	3.25	9.5
34	21,911	6.42	36,519	10.70	38,344	11.24	2,539	3,320	3,564	3.20	9.4
35	22,556	6.61	37,593	11.02	39,472	11.57	2,708	3,429	3,669	3.20	9.4
36	23,200	6.80	38,667	11.33	40,600	11.90	2,793	3,537	3,773	3.20	9.3
37	23,844	6.99	39,741	11.65	41,728	12.23	2,879	3,646	3,878	3.20	9.3
38	24,489	7.18	40,815	11.96	42,856	12.56	2,965	3,754	3,983	3.20	9.2
39	25,133	7.37	41,889	12.28	43,983	12.89	3,090	3,863	4,088	3.15	9.2
40	25,778	7.56	42,963	12.59	45,111	13.22	3,177	3,971	4,193	3.15	9.1
41	26,422	7.74	44,037	12.91	46,239	13.55	3,264	4,080	4,298	3.15	9.1
42	27,067	7.93	45,111	13.22	47,367	13.88	3,350	4,188	4,402	3.15	9.0
43	27,711	8.12	46,185	13.54	48,494	14.21	3,437	4,297	4,507	3.15	9.0
44	28,356	8.31	47,259	13.85	49,622	14.54	3,524	4,405	4,612	3.15	8.9
45	29,000	8.50	48,333	14.17	50,750	14.87	3,611	4,514	4,717	3.15	8.8
46	29,644	8.69	49,407	14.48	51,878	15.20	3,698	4,622	4,822	3.15	8.8
47	30,289	8.88	50,481	14.80	53,006	15.54	3,784	4,731	4,926	3.15	8.7
48	30,933	9.07	51,556	15.11	54,133	15.87	3,871	4,839	5,031	3.15	8.7
49	31,578	9.25	52,630	15.42	55,261	16.20	3,958	4,948	5,136	3.15	8.6
50	32,222	9.44	53,704	15.74	56,389	16.53	4,045	5,056	5,241	3.15	8.6
51	32,867	9.63	54,778	16.05	57,517	16.86	4,132	5,165	5,346	3.15	8.5
52	33,511	9.82	55,852	16.37	58,644	17.19	4,218	5,273	5,451	3.15	8.5
53	34,156	10.01	56,926	16.68	59,772	17.52	4,305	5,382	5,555	3.10	8.4
54	34,800	10.20	58,000	17.00	60,900	17.85	4,392	5,490	5,660	3.05	8.35
55	35,444	10.39	59,074	17.31	62,028	18.18	4,479	5,598	5,765	3.05	8.35
56	36,089	10.58	60,148	17.62	63,156	18.51	4,566	5,706	5,870	3.05	8.35
57	36,733	10.77	61,222	17.93	64,284	18.84	4,653	5,814	5,975	3.05	8.35
58	37,378	10.96	62,296	18.24	65,412	19.17	4,740	5,922	6,080	3.05	8.35
59	38,022	11.15	63,370	18.55	66,540	19.50	4,827	6,030	6,185	3.05	8.35
60	38,667	11.34	64,444	18.86	67,668	19.83	4,914	6,138	6,290	3.05	8.35
61	39,311	11.53	65,518	19.17	68,796	20.16	5,001	6,246	6,395	3.05	8.35
62	39,956	11.72	66,592	19.48	69,924	20.49	5,088	6,354	6,500	3.05	8.35
63	40,600	11.91	67,666	19.79	71,052	20.82	5,175	6,462	6,605	3.05	8.35
64	41,244	12.10	68,740	20.10	72,180	21.15	5,262	6,570	6,710	3.05	8.35
65	41,889	12.29	69,814	20.41	73,308	21.48	5,349	6,678	6,815	3.05	8.35
66	42,533	12.48	70,888	20.72	74,436	21.81	5,436	6,786	6,920	3.05	8.35
67	43,178	12.67	71,962	21.03	75,564	22.14	5,523	6,894	7,025	3.05	8.35
68	43,822	12.86	73,036	21.34	76,692	22.47	5,610	7,002	7,130	3.05	8.35
69	44,467	13.05	74,110	21.65	77,820	22.80	5,697	7,110	7,235	3.05	8.35
70	45,111	13.24	75,184	21.96	78,948	23.13	5,784	7,218	7,340	3.05	8.35
71	45,756	13.43	76,258	22.27	80,076	23.46	5,871	7,326	7,445	3.05	8.35
72	46,400	13.62	77,332	22.58	81,204	23.79	5,958	7,434	7,550	3.05	8.35
73	47,044	13.81	78,406	22.89	82,332	24.12	6,045	7,542	7,655	3.05	8.35

<sup>1</sup>Capacity as rated: 0 ft. above sea level with Piping Length as Main Pipe (16.4 ft.) + Branch pipe (98.4 ft.) = 115 ft.  
0 ft. level difference between outdoor and indoor units.

<sup>2</sup>Heating capacity rating obtained with air entering the indoor unit at 70°F dry bulb (DB) and 60°F wet bulb (WB), and outdoor ambient conditions of 47°F dry bulb (DB) and 43°F wet bulb (WB).

<sup>3</sup>Wiring cable size must comply with the applicable local and national codes.

<sup>4</sup>The specification may be subject to change without prior notice for purpose of improvement.

<sup>5</sup>Sum of connected indoor units capacity is 24-73 kBtu/h.

<sup>6</sup>At least two indoor units should be connected.



Multi F and Multi F MAX Heat Pump System Engineering Manual

Table 123: LMU540HV Cooling Capacity Table — Non-Ducted Indoor Units.

Combination Capacity Index (kBtu/h[%])	Outdoor Air Temp. (°F DB)	Indoor Air Temp. °F DB / °F WB											
		68 / 57		73 / 61		77 / 64		80 / 67		86 / 72		90 / 75	
		TC	PI	TC	PI	TC	PI	TC	PI	TC	PI	TC	PI
Non-Ducted Indoor Units 73 (135%)	14	54.55	3.55	57.94	3.68	61.33	3.82	63.78	3.86	68.11	3.94	71.49	4.01
	20	54.51	3.61	57.90	3.74	61.28	3.87	63.73	3.92	68.05	3.99	71.44	4.07
	25	54.47	3.66	57.85	3.79	61.24	3.93	63.68	3.97	68.00	4.05	71.38	4.13
	30	54.43	3.71	57.81	3.84	61.19	3.98	63.63	4.03	67.95	4.10	71.33	4.19
	35	54.39	3.76	57.76	3.90	61.14	4.04	63.58	4.08	67.90	4.16	71.28	4.25
	40	54.35	3.81	57.72	3.95	61.10	4.09	63.53	4.14	67.85	4.22	71.22	4.30
	45	54.30	3.86	57.68	4.00	61.05	4.15	63.48	4.20	67.79	4.27	71.17	4.36
	50	54.26	3.91	57.63	4.05	61.00	4.20	63.44	4.25	67.74	4.33	71.11	4.42
	55	54.22	3.96	57.59	4.11	60.96	4.26	63.39	4.31	67.69	4.39	71.06	4.48
	60	54.18	4.01	57.54	4.16	60.91	4.31	63.34	4.36	67.64	4.44	71.00	4.53
	65	54.14	4.07	57.50	4.21	60.86	4.37	63.29	4.42	67.59	4.50	70.95	4.59
	70	54.10	4.12	57.46	4.27	60.82	4.42	63.24	4.47	67.53	4.56	70.89	4.65
	75	52.79	4.34	56.15	4.50	59.50	4.66	61.92	4.71	66.20	4.80	69.55	4.90
	80	51.49	4.56	54.84	4.73	58.18	4.90	60.59	4.96	64.86	5.05	68.21	5.15
	85	50.20	4.78	53.54	4.96	56.87	5.14	59.28	5.20	63.54	5.29	66.88	5.40
	90	48.91	5.00	52.24	5.19	55.56	5.38	57.97	5.44	62.22	5.54	65.54	5.65
	95	47.51	5.23	50.82	5.42	54.13	5.62	<b>55.65</b>	<b>5.68</b>	60.75	5.79	64.06	5.90
	100	46.35	5.45	49.66	5.65	52.97	5.85	54.93	5.92	59.59	6.03	62.90	6.15
	105	45.20	5.67	48.51	5.88	51.82	6.09	54.21	6.16	58.44	6.28	61.75	6.40
	110	44.04	5.89	47.35	6.11	50.66	6.33	53.05	6.40	57.28	6.52	60.59	6.66
115	42.88	6.11	46.19	6.34	49.50	6.57	51.89	6.65	56.12	6.77	59.43	6.91	
118	42.19	6.25	45.50	6.48	48.81	6.71	51.20	6.79	55.43	6.92	58.74	7.06	
122	41.96	6.43	45.27	6.66	48.58	6.90	50.97	6.98	55.20	7.11	58.51	7.26	
Non-Ducted Indoor Units 70 (130%)	14	54.06	3.50	57.42	3.63	60.78	3.76	63.20	3.80	67.49	3.87	70.85	3.95
	20	54.02	3.55	57.38	3.68	60.73	3.81	63.16	3.86	67.44	3.93	70.80	4.01
	25	53.98	3.60	57.33	3.73	60.69	3.87	63.11	3.91	67.39	3.98	70.74	4.06
	30	53.94	3.65	57.29	3.78	60.64	3.92	63.06	3.97	67.34	4.04	70.69	4.12
	35	53.90	3.70	57.25	3.83	60.59	3.97	63.01	4.02	67.29	4.10	70.64	4.18
	40	53.86	3.75	57.20	3.89	60.55	4.03	62.96	4.07	67.24	4.15	70.58	4.23
	45	53.82	3.80	57.16	3.94	60.50	4.08	62.91	4.13	67.18	4.21	70.53	4.29
	50	53.77	3.85	57.11	3.99	60.45	4.14	62.87	4.18	67.13	4.26	70.47	4.35
	55	53.73	3.90	57.07	4.04	60.41	4.19	62.82	4.24	67.08	4.32	70.42	4.40
	60	53.69	3.95	57.03	4.09	60.36	4.24	62.77	4.29	67.03	4.37	70.36	4.46
	65	53.65	4.00	56.98	4.15	60.31	4.30	62.72	4.35	66.98	4.43	70.31	4.52
	70	53.61	4.05	56.94	4.20	60.27	4.35	62.67	4.40	66.93	4.48	70.26	4.58
	75	52.32	4.27	55.64	4.43	58.96	4.59	61.36	4.64	65.60	4.73	68.93	4.82
	80	51.03	4.49	54.34	4.65	57.66	4.82	60.05	4.88	64.28	4.97	67.59	5.07
	85	49.75	4.71	53.06	4.88	56.36	5.06	58.75	5.11	62.97	5.21	66.28	5.32
	90	48.47	4.93	51.77	5.11	55.07	5.29	57.45	5.35	61.66	5.45	64.96	5.56
	95	47.08	5.14	50.36	5.33	53.65	5.53	<b>55.15</b>	<b>5.59</b>	60.21	5.69	63.49	5.81
	100	45.94	5.36	49.22	5.56	52.50	5.76	54.44	5.83	59.06	5.94	62.34	6.06
	105	44.79	5.58	48.07	5.78	51.35	6.00	53.72	6.07	57.91	6.18	61.19	6.30
	110	43.64	5.80	46.93	6.01	50.21	6.23	52.57	6.30	56.77	6.42	60.05	6.55
115	42.50	6.02	45.78	6.24	49.06	6.47	51.43	6.54	55.62	6.66	58.90	6.80	
118	41.81	6.15	45.09	6.37	48.37	6.61	50.74	6.68	54.93	6.81	58.21	6.94	
122	41.58	6.32	44.86	6.55	48.14	6.79	50.51	6.87	54.70	7.00	57.98	7.14	

TC = Total Capacity (kBtu/h).

PI = Power Input (kW).

Nominal capacity as rated: 0 ft. above sea level with Piping Length as Main Pipe (16.4 ft.) + Branch pipe (98.4 ft.) = 115 ft.  
0 ft. level difference between outdoor and indoor units.

Nominal cooling capacity rating obtained with air entering the indoor unit at 80°F dry bulb (DB) and 67°F wet bulb (WB), and outdoor ambient conditions of 95°F dry bulb (DB) and 75°F wet bulb (WB).

The shaded table columns and rows indicate reference data. When operating at this temperature, these values can be different if the system is not running consistently.

# PERFORMANCE DATA

## Cooling Capacity Tables

MULTI F  
MULTI F MAX

Table 124: LMU540HV Cooling Capacity Table — Non-Ducted Indoor Units (continued).

Combination Capacity Index (kBtu/h[%])	Outdoor Air Temp. (°F DB)	Indoor Air Temp. °F DB / °F WB											
		68 / 57		73 / 61		77 / 64		80 / 67		86 / 72		90 / 75	
		TC	PI	TC	PI	TC	PI	TC	PI	TC	PI	TC	PI
Non-Ducted Indoor Units 65 (120%)	14	53.25	3.40	56.56	3.53	59.86	3.66	62.25	3.70	66.48	3.77	69.79	3.84
	20	53.21	3.45	56.51	3.58	59.82	3.71	62.20	3.75	66.43	3.82	69.73	3.90
	25	53.17	3.50	56.47	3.63	59.77	3.76	62.16	3.81	66.38	3.88	69.68	3.96
	30	53.13	3.55	56.43	3.68	59.73	3.82	62.11	3.86	66.33	3.93	69.63	4.01
	35	53.09	3.60	56.38	3.73	59.68	3.87	62.06	3.91	66.28	3.99	69.57	4.07
	40	53.05	3.65	56.34	3.78	59.64	3.92	62.01	3.97	66.22	4.04	69.52	4.12
	45	53.01	3.70	56.30	3.83	59.59	3.97	61.97	4.02	66.17	4.09	69.47	4.18
	50	52.97	3.75	56.25	3.88	59.54	4.03	61.92	4.07	66.12	4.15	69.41	4.23
	55	52.92	3.80	56.21	3.93	59.50	4.08	61.87	4.12	66.07	4.20	69.36	4.29
	60	52.88	3.84	56.17	3.98	59.45	4.13	61.82	4.18	66.02	4.26	69.31	4.34
	65	52.84	3.89	56.13	4.04	59.41	4.18	61.78	4.23	65.97	4.31	69.25	4.40
	70	52.80	3.94	56.08	4.09	59.36	4.24	61.73	4.28	65.92	4.36	69.20	4.45
	75	51.53	4.16	54.80	4.31	58.07	4.46	60.44	4.52	64.62	4.60	67.89	4.69
	80	50.26	4.37	53.52	4.53	56.79	4.69	59.14	4.75	63.31	4.84	66.58	4.93
	85	49.00	4.58	52.26	4.75	55.51	4.92	57.86	4.98	62.02	5.07	65.28	5.17
	90	47.74	4.79	50.99	4.97	54.24	5.15	56.58	5.21	60.73	5.31	63.98	5.41
	95	46.38	5.01	49.61	5.19	52.84	5.38	54.32	5.44	59.30	5.54	62.53	5.65
	100	45.25	5.22	48.48	5.41	51.71	5.61	53.62	5.67	58.17	5.78	61.40	5.89
105	44.12	5.43	47.35	5.63	50.58	5.84	52.91	5.90	57.04	6.01	60.27	6.13	
110	42.99	5.64	46.22	5.85	49.45	6.06	51.78	6.13	55.91	6.25	59.14	6.37	
115	41.86	5.86	45.09	6.07	48.32	6.29	50.65	6.36	54.78	6.48	58.01	6.61	
118	41.18	5.98	44.41	6.20	47.64	6.43	49.98	6.50	54.10	6.63	57.34	6.76	
122	40.96	6.15	44.19	6.38	47.42	6.61	49.75	6.69	53.88	6.81	57.11	6.95	
Non-Ducted Indoor Units 59 (110%)	14	52.28	3.29	55.53	3.41	58.77	3.53	61.12	3.57	65.27	3.64	68.51	3.71
	20	52.24	3.33	55.48	3.45	58.73	3.58	61.07	3.62	65.22	3.69	68.46	3.76
	25	52.20	3.38	55.44	3.50	58.68	3.63	61.02	3.67	65.17	3.74	68.41	3.82
	30	52.16	3.43	55.40	3.55	58.64	3.68	60.98	3.72	65.12	3.79	68.36	3.87
	35	52.12	3.47	55.36	3.60	58.59	3.73	60.93	3.78	65.07	3.85	68.30	3.92
	40	52.08	3.52	55.31	3.65	58.55	3.78	60.88	3.83	65.02	3.90	68.25	3.98
	45	52.04	3.57	55.27	3.70	58.50	3.83	60.84	3.88	64.97	3.95	68.20	4.03
	50	52.00	3.62	55.23	3.75	58.46	3.88	60.79	3.93	64.92	4.00	68.15	4.08
	55	51.96	3.66	55.19	3.80	58.41	3.94	60.74	3.98	64.87	4.06	68.10	4.14
	60	51.92	3.71	55.14	3.85	58.37	3.99	60.70	4.03	64.82	4.11	68.04	4.19
	65	51.88	3.76	55.10	3.89	58.32	4.04	60.65	4.08	64.77	4.16	67.99	4.24
	70	51.84	3.80	55.06	3.94	58.28	4.09	60.60	4.13	64.72	4.21	67.94	4.30
	75	50.59	4.01	53.80	4.16	57.02	4.31	59.34	4.36	63.44	4.44	66.65	4.53
	80	49.35	4.22	52.55	4.37	55.75	4.53	58.07	4.58	62.16	4.67	65.36	4.76
	85	48.11	4.42	51.30	4.58	54.50	4.75	56.81	4.80	60.89	4.89	64.09	4.99
	90	46.87	4.63	50.06	4.79	53.25	4.97	55.55	5.03	59.62	5.12	62.81	5.22
	95	45.53	4.83	48.70	5.01	51.87	5.19	53.33	5.25	58.22	5.35	61.39	5.46
	100	44.42	5.04	47.59	5.22	50.77	5.41	52.64	5.47	57.11	5.58	60.28	5.69
105	43.31	5.24	46.49	5.43	49.66	5.63	51.95	5.70	56.00	5.80	59.17	5.92	
110	42.20	5.45	45.38	5.65	48.55	5.85	50.84	5.92	54.89	6.03	58.06	6.15	
115	41.10	5.65	44.27	5.86	47.44	6.07	49.73	6.14	53.78	6.26	56.96	6.38	
118	40.43	5.78	43.60	5.99	46.77	6.20	49.07	6.28	53.12	6.39	56.29	6.52	
122	40.21	5.94	43.38	6.16	46.55	6.38	48.84	6.45	52.90	6.58	56.07	6.71	

TC = Total Capacity (kBtu/h).

PI = Power Input (kW).

Nominal capacity as rated: 0 ft. above sea level with Piping Length as Main Pipe (16.4 ft.) + Branch pipe (98.4 ft.) = 115 ft.  
0 ft. level difference between outdoor and indoor units.

Nominal cooling capacity rating obtained with air entering the indoor unit at 80°F dry bulb (DB) and 67°F wet bulb (WB), and outdoor ambient conditions of 95°F dry bulb (DB) and 75°F wet bulb (WB).

The shaded table columns and rows indicate reference data. When operating at this temperature, these values can be different if the system is not running consistently.



Multi F and Multi F MAX Heat Pump System Engineering Manual

Table 125: LMU540HV Cooling Capacity Table — Non-Ducted Indoor Units.

Combination Capacity Index (kBtu/h[%])	Outdoor Air Temp. (°F DB)	Indoor Air Temp. °F DB / °F WB											
		68 / 57		73 / 61		77 / 64		80 / 67		86 / 72		90 / 75	
		TC	PI	TC	PI	TC	PI	TC	PI	TC	PI	TC	PI
Non-Ducted Indoor Units 54 (100%)	14	51.47	3.19	54.66	3.31	57.86	3.43	60.17	3.47	64.25	3.53	67.45	3.60
	20	51.43	3.24	54.62	3.36	57.81	3.48	60.12	3.52	64.20	3.58	67.40	3.66
	25	51.39	3.28	54.58	3.40	57.77	3.53	60.07	3.57	64.15	3.63	67.34	3.71
	30	51.35	3.33	54.54	3.45	57.73	3.58	60.03	3.62	64.10	3.69	67.29	3.76
	35	51.31	3.38	54.50	3.50	57.68	3.63	59.98	3.67	64.05	3.74	67.24	3.81
	40	51.27	3.42	54.45	3.55	57.64	3.68	59.94	3.72	64.01	3.79	67.19	3.86
	45	51.23	3.47	54.41	3.59	57.59	3.72	59.89	3.77	63.96	3.84	67.14	3.92
	50	51.19	3.51	54.37	3.64	57.55	3.77	59.85	3.82	63.91	3.89	67.09	3.97
	55	51.15	3.56	54.33	3.69	57.51	3.82	59.80	3.87	63.86	3.94	67.04	4.02
	60	51.11	3.60	54.29	3.74	57.46	3.87	59.75	3.92	63.81	3.99	66.98	4.07
	65	51.07	3.65	54.24	3.78	57.42	3.92	59.71	3.97	63.76	4.04	66.93	4.12
	70	51.03	3.70	54.20	3.83	57.37	3.97	59.66	4.02	63.71	4.09	66.88	4.17
	75	49.81	3.90	52.97	4.04	56.13	4.19	58.41	4.23	62.45	4.31	65.61	4.40
	80	48.58	4.09	51.73	4.24	54.89	4.40	57.16	4.45	61.19	4.53	64.35	4.62
	85	47.36	4.29	50.51	4.45	53.65	4.61	55.92	4.67	59.94	4.75	63.09	4.85
	90	46.14	4.49	49.28	4.66	52.42	4.83	54.69	4.88	58.70	4.97	61.83	5.07
	95	44.82	4.69	47.94	4.86	51.07	5.04	<b>52.50</b>	<b>5.10</b>	57.31	5.20	60.44	5.30
	100	43.73	4.89	46.85	5.07	49.98	5.26	51.82	5.32	56.22	5.42	59.34	5.53
105	42.64	5.09	45.76	5.28	48.88	5.47	51.14	5.53	55.13	5.64	58.25	5.75	
110	41.55	5.29	44.67	5.48	47.79	5.68	50.05	5.75	54.04	5.86	57.16	5.98	
115	40.46	5.49	43.58	5.69	46.70	5.90	48.96	5.97	52.95	6.08	56.07	6.20	
118	39.80	5.61	42.92	5.82	46.05	6.03	48.30	6.10	52.29	6.21	55.41	6.34	
122	39.58	5.77	42.71	5.98	45.83	6.20	48.08	6.27	52.07	6.39	55.20	6.52	
Non-Ducted Indoor Units 49 (90%)	14	46.70	2.82	49.60	2.93	52.50	3.03	54.60	3.07	58.30	3.12	61.20	3.19
	20	46.67	2.86	49.56	2.97	52.46	3.08	54.56	3.11	58.26	3.17	61.16	3.23
	25	46.63	2.90	49.53	3.01	52.42	3.12	54.51	3.16	58.21	3.21	61.11	3.28
	30	46.59	2.94	49.49	3.05	52.38	3.16	54.47	3.20	58.17	3.26	61.06	3.32
	35	46.56	2.98	49.45	3.09	52.34	3.21	54.43	3.24	58.12	3.30	61.02	3.37
	40	46.52	3.03	49.41	3.14	52.30	3.25	54.39	3.29	58.08	3.35	60.97	3.42
	45	46.49	3.07	49.37	3.18	52.26	3.29	54.35	3.33	58.04	3.39	60.92	3.46
	50	46.45	3.11	49.34	3.22	52.22	3.34	54.31	3.38	57.99	3.44	60.88	3.51
	55	46.42	3.15	49.30	3.26	52.18	3.38	54.26	3.42	57.95	3.48	60.83	3.55
	60	46.38	3.19	49.26	3.30	52.14	3.42	54.22	3.46	57.90	3.53	60.78	3.60
	65	46.35	3.23	49.22	3.35	52.10	3.47	54.18	3.51	57.86	3.57	60.74	3.65
	70	46.31	3.27	49.19	3.39	52.06	3.51	54.14	3.55	57.81	3.62	60.69	3.69
	75	45.20	3.44	48.06	3.57	50.93	3.70	53.01	3.74	56.67	3.81	59.54	3.89
	80	44.08	3.62	46.94	3.75	49.80	3.89	51.87	3.94	55.53	4.01	58.39	4.09
	85	42.98	3.80	45.83	3.94	48.69	4.08	50.75	4.13	54.40	4.20	57.25	4.29
	90	41.87	3.97	44.72	4.12	47.57	4.27	49.62	4.32	53.26	4.40	56.11	4.49
	95	40.67	4.15	43.51	4.30	46.34	4.46	<b>47.64</b>	<b>4.51</b>	52.01	4.59	54.84	4.69
	100	39.68	4.33	42.52	4.48	45.35	4.65	47.02	4.70	51.02	4.79	53.85	4.89
105	38.69	4.50	41.53	4.67	44.36	4.84	46.41	4.89	50.03	4.98	52.86	5.09	
110	37.70	4.68	40.54	4.85	43.37	5.03	45.42	5.08	49.04	5.18	51.87	5.28	
115	36.71	4.86	39.54	5.03	42.38	5.22	44.42	5.28	48.05	5.38	50.88	5.48	
118	36.12	4.96	38.95	5.14	41.78	5.33	43.83	5.39	47.45	5.49	50.28	5.60	
122	35.92	5.10	38.75	5.29	41.59	5.48	43.63	5.54	47.25	5.65	50.09	5.76	

TC = Total Capacity (kBtu/h).

PI = Power Input (kW).

Nominal capacity as rated: 0 ft. above sea level with Piping Length as Main Pipe (16.4 ft.) + Branch pipe (98.4 ft.) = 115 ft.  
0 ft. level difference between outdoor and indoor units.

Nominal cooling capacity rating obtained with air entering the indoor unit at 80°F dry bulb (DB) and 67°F wet bulb (WB), and outdoor ambient conditions of 95°F dry bulb (DB) and 75°F wet bulb (WB).

The shaded table columns and rows indicate reference data. When operating at this temperature, these values can be different if the system is not running consistently.

# PERFORMANCE DATA

## Cooling Capacity Tables

MULTI F  
MULTI F MAX

Table 126: LMU540HV Cooling Capacity Table — Non-Ducted Indoor Units (continued).

Combination Capacity Index (kBtu/h[%])	Outdoor Air Temp. (°F DB)	Indoor Air Temp. °F DB / °F WB											
		68 / 57		73 / 61		77 / 64		80 / 67		86 / 72		90 / 75	
		TC	PI	TC	PI	TC	PI	TC	PI	TC	PI	TC	PI
Non-Ducted Indoor Units 43 (80%)	14	40.99	2.38	43.53	2.46	46.08	2.55	47.92	2.58	51.17	2.63	53.71	2.69
	20	40.95	2.41	43.50	2.50	46.04	2.59	47.88	2.62	51.13	2.67	53.67	2.72
	25	40.92	2.45	43.47	2.54	46.01	2.63	47.84	2.66	51.09	2.71	53.63	2.76
	30	40.89	2.48	43.43	2.57	45.97	2.66	47.81	2.70	51.05	2.75	53.59	2.80
	35	40.86	2.51	43.40	2.61	45.94	2.70	47.77	2.73	51.01	2.78	53.55	2.84
	40	40.83	2.55	43.37	2.64	45.90	2.74	47.73	2.77	50.97	2.82	53.51	2.88
	45	40.80	2.58	43.33	2.68	45.87	2.78	47.70	2.81	50.93	2.86	53.47	2.92
	50	40.77	2.62	43.30	2.71	45.83	2.81	47.66	2.84	50.89	2.90	53.43	2.96
	55	40.74	2.65	43.27	2.75	45.80	2.85	47.62	2.88	50.86	2.94	53.39	2.99
	60	40.70	2.69	43.23	2.78	45.76	2.89	47.59	2.92	50.82	2.97	53.34	3.03
	65	40.67	2.72	43.20	2.82	45.73	2.92	47.55	2.96	50.78	3.01	53.30	3.07
	70	40.64	2.75	43.17	2.85	45.69	2.96	47.51	2.99	50.74	3.05	53.26	3.11
	75	39.66	2.90	42.18	3.01	44.70	3.12	46.52	3.15	49.74	3.21	52.25	3.28
	80	38.69	3.05	41.20	3.16	43.71	3.28	45.52	3.32	48.73	3.38	51.24	3.45
	85	37.72	3.20	40.22	3.32	42.73	3.44	44.54	3.48	47.74	3.54	50.24	3.61
	90	36.75	3.35	39.25	3.47	41.75	3.60	43.55	3.64	46.74	3.71	49.24	3.78
	95	35.70	3.50	38.18	3.62	40.67	3.76	<b>41.81</b>	<b>3.80</b>	45.64	3.87	48.13	3.95
	100	34.83	3.65	37.31	3.78	39.80	3.92	41.27	3.96	44.77	4.04	47.26	4.12
	105	33.96	3.79	36.44	3.93	38.93	4.08	40.73	4.12	43.90	4.20	46.39	4.28
	110	33.09	3.94	35.57	4.09	38.06	4.24	39.86	4.28	43.03	4.36	45.52	4.45
115	32.22	4.09	34.71	4.24	37.19	4.40	38.99	4.45	42.17	4.53	44.65	4.62	
118	31.70	4.18	34.18	4.33	36.67	4.49	38.47	4.54	41.64	4.63	44.13	4.72	
122	31.52	4.30	34.01	4.46	36.50	4.62	38.29	4.67	41.47	4.76	43.96	4.86	
Non-Ducted Indoor Units 38 (70%)	14	36.21	2.01	38.46	2.08	40.71	2.16	42.33	2.18	45.21	2.22	47.46	2.27
	20	36.18	2.04	38.43	2.11	40.68	2.19	42.30	2.21	45.17	2.26	47.42	2.30
	25	36.16	2.07	38.40	2.14	40.65	2.22	42.27	2.25	45.14	2.29	47.38	2.33
	30	36.13	2.10	38.37	2.17	40.62	2.25	42.24	2.28	45.10	2.32	47.35	2.37
	35	36.10	2.12	38.34	2.20	40.59	2.28	42.21	2.31	45.07	2.35	47.31	2.40
	40	36.07	2.15	38.31	2.23	40.55	2.31	42.17	2.34	45.04	2.38	47.28	2.43
	45	36.05	2.18	38.29	2.26	40.52	2.34	42.14	2.37	45.00	2.42	47.24	2.46
	50	36.02	2.21	38.26	2.29	40.49	2.38	42.11	2.40	44.97	2.45	47.20	2.50
	55	35.99	2.24	38.23	2.32	40.46	2.41	42.08	2.43	44.93	2.48	47.17	2.53
	60	35.96	2.27	38.20	2.35	40.43	2.44	42.04	2.47	44.90	2.51	47.13	2.56
	65	35.94	2.30	38.17	2.38	40.40	2.47	42.01	2.50	44.86	2.54	47.09	2.59
	70	35.91	2.33	38.14	2.41	40.37	2.50	41.98	2.53	44.83	2.58	47.06	2.63
	75	35.04	2.45	37.27	2.54	39.49	2.63	41.10	2.66	43.94	2.71	46.17	2.77
	80	34.18	2.58	36.40	2.67	38.62	2.77	40.22	2.80	43.06	2.85	45.28	2.91
	85	33.32	2.70	35.54	2.80	37.75	2.90	39.35	2.94	42.18	2.99	44.39	3.05
	90	32.47	2.83	34.68	2.93	36.88	3.04	38.48	3.07	41.30	3.13	43.51	3.19
	95	31.54	2.95	33.73	3.06	35.93	3.17	<b>36.94</b>	<b>3.21</b>	40.33	3.27	42.52	3.34
	100	30.77	3.08	32.97	3.19	35.16	3.31	36.46	3.35	39.56	3.41	41.76	3.48
	105	30.00	3.20	32.20	3.32	34.40	3.44	35.98	3.48	38.79	3.55	40.99	3.62
	110	29.23	3.33	31.43	3.45	33.63	3.58	35.21	3.62	38.02	3.69	40.22	3.76
115	28.47	3.46	30.66	3.58	32.86	3.71	34.45	3.76	37.25	3.83	39.45	3.90	
118	28.01	3.53	30.20	3.66	32.40	3.79	33.99	3.84	36.79	3.91	38.99	3.99	
122	27.85	3.63	30.05	3.76	32.25	3.90	33.83	3.95	36.64	4.02	38.84	4.10	

TC = Total Capacity (kBtu/h).

PI = Power Input (kW).

Nominal capacity as rated: 0 ft. above sea level with Piping Length as Main Pipe (16.4 ft.) + Branch pipe (98.4 ft.) = 115 ft.  
0 ft. level difference between outdoor and indoor units.

Nominal cooling capacity rating obtained with air entering the indoor unit at 80°F dry bulb (DB) and 67°F wet bulb (WB), and outdoor ambient conditions of 95°F dry bulb (DB) and 75°F wet bulb (WB).

The shaded table columns and rows indicate reference data. When operating at this temperature, these values can be different if the system is not running consistently.



Multi F and Multi F MAX Heat Pump System Engineering Manual

Table 127: LMU540HV Cooling Capacity Table — Non-Ducted Indoor Units (continued).

Combination Capacity Index (kBtu/h[%])	Outdoor Air Temp. (°F DB)	Indoor Air Temp. °F DB / °F WB											
		68 / 57		73 / 61		77 / 64		80 / 67		86 / 72		90 / 75	
		TC	PI	TC	PI	TC	PI	TC	PI	TC	PI	TC	PI
Non-Ducted Indoor Units 32 (60%)	14	30.50	1.56	32.39	1.62	34.29	1.68	35.65	1.70	38.07	1.73	39.97	1.77
	20	30.47	1.59	32.37	1.64	34.26	1.70	35.63	1.72	38.04	1.76	39.94	1.79
	25	30.45	1.61	32.34	1.67	34.23	1.73	35.60	1.75	38.01	1.78	39.91	1.82
	30	30.43	1.63	32.32	1.69	34.21	1.75	35.57	1.77	37.99	1.81	39.88	1.84
	35	30.40	1.65	32.29	1.71	34.18	1.78	35.54	1.80	37.96	1.83	39.85	1.87
	40	30.38	1.68	32.27	1.74	34.15	1.80	35.52	1.82	37.93	1.86	39.81	1.89
	45	30.36	1.70	32.24	1.76	34.13	1.83	35.49	1.85	37.90	1.88	39.78	1.92
	50	30.33	1.72	32.22	1.78	34.10	1.85	35.46	1.87	37.87	1.91	39.75	1.94
	55	30.31	1.74	32.19	1.81	34.08	1.87	35.44	1.90	37.84	1.93	39.72	1.97
	60	30.29	1.77	32.17	1.83	34.05	1.90	35.41	1.92	37.81	1.96	39.69	2.00
	65	30.26	1.79	32.14	1.85	34.02	1.92	35.38	1.94	37.78	1.98	39.66	2.02
	70	30.24	1.81	32.12	1.88	34.00	1.95	35.35	1.97	37.75	2.01	39.63	2.05
	75	29.51	1.91	31.39	1.98	33.26	2.05	34.61	2.08	37.01	2.11	38.88	2.16
	80	28.79	2.01	30.65	2.08	32.52	2.16	33.87	2.18	36.26	2.22	38.13	2.27
	85	28.06	2.10	29.93	2.18	31.79	2.26	33.14	2.29	35.52	2.33	37.39	2.38
	90	27.34	2.20	29.20	2.28	31.06	2.37	32.41	2.39	34.78	2.44	36.64	2.49
	95	26.56	2.30	28.41	2.38	30.26	2.47	<b>31.11</b>	<b>2.50</b>	33.96	2.55	35.81	2.60
	100	25.91	2.40	27.76	2.49	29.61	2.58	30.71	2.61	33.32	2.66	35.17	2.71
105	25.27	2.50	27.12	2.59	28.97	2.68	30.30	2.71	32.67	2.76	34.52	2.82	
110	24.62	2.59	26.47	2.69	28.32	2.79	29.66	2.82	32.02	2.87	33.87	2.93	
115	23.97	2.69	25.82	2.79	27.67	2.89	29.01	2.92	31.37	2.98	33.23	3.04	
118	23.59	2.75	25.44	2.85	27.29	2.95	28.62	2.99	30.99	3.04	32.84	3.11	
122	23.46	2.83	25.31	2.93	27.16	3.04	28.49	3.07	30.86	3.13	32.71	3.19	
Non-Ducted Indoor Units 27 (50%)	14	25.73	1.20	27.33	1.24	28.93	1.28	30.08	1.30	32.13	1.32	33.72	1.35
	20	25.71	1.21	27.31	1.26	28.91	1.30	30.06	1.32	32.10	1.34	33.70	1.37
	25	25.69	1.23	27.29	1.27	28.88	1.32	30.04	1.34	32.08	1.36	33.67	1.39
	30	25.67	1.25	27.27	1.29	28.86	1.34	30.01	1.35	32.05	1.38	33.65	1.41
	35	25.65	1.26	27.25	1.31	28.84	1.36	29.99	1.37	32.03	1.40	33.62	1.43
	40	25.63	1.28	27.23	1.33	28.82	1.38	29.97	1.39	32.00	1.42	33.59	1.45
	45	25.62	1.30	27.21	1.35	28.80	1.39	29.95	1.41	31.98	1.44	33.57	1.47
	50	25.60	1.32	27.19	1.36	28.77	1.41	29.92	1.43	31.95	1.46	33.54	1.49
	55	25.58	1.33	27.16	1.38	28.75	1.43	29.90	1.45	31.93	1.48	33.52	1.51
	60	25.56	1.35	27.14	1.40	28.73	1.45	29.88	1.47	31.90	1.49	33.49	1.52
	65	25.54	1.37	27.12	1.42	28.71	1.47	29.85	1.49	31.88	1.51	33.47	1.54
	70	25.52	1.38	27.10	1.43	28.69	1.49	29.83	1.50	31.86	1.53	33.44	1.56
	75	24.90	1.46	26.48	1.51	28.06	1.57	29.21	1.59	31.23	1.62	32.81	1.65
	80	24.29	1.53	25.87	1.59	27.44	1.65	28.58	1.67	30.60	1.70	32.17	1.73
	85	23.68	1.61	25.25	1.67	26.83	1.73	27.96	1.75	29.97	1.78	31.55	1.82
	90	23.07	1.68	24.64	1.74	26.21	1.81	27.34	1.83	29.35	1.86	30.92	1.90
	95	22.41	1.76	23.97	1.82	25.53	1.89	<b>26.25</b>	<b>1.91</b>	28.66	1.95	30.22	1.98
	100	21.87	1.83	23.43	1.90	24.99	1.97	25.91	1.99	28.11	2.03	29.67	2.07
105	21.32	1.91	22.88	1.98	24.44	2.05	25.57	2.07	27.56	2.11	29.13	2.15	
110	20.77	1.98	22.34	2.05	23.90	2.13	25.02	2.15	27.02	2.19	28.58	2.24	
115	20.23	2.06	21.79	2.13	23.35	2.21	24.48	2.23	26.47	2.28	28.03	2.32	
118	19.90	2.10	21.46	2.18	23.02	2.26	24.15	2.28	26.15	2.33	27.71	2.37	
122	19.79	2.16	21.35	2.24	22.91	2.32	24.04	2.35	26.04	2.39	27.60	2.44	

TC = Total Capacity (kBtu/h).

PI = Power Input (kW).

Nominal capacity as rated: 0 ft. above sea level with Piping Length as Main Pipe (16.4 ft.) + Branch pipe (98.4 ft.) = 115 ft.  
0 ft. level difference between outdoor and indoor units.

Nominal cooling capacity rating obtained with air entering the indoor unit at 80°F dry bulb (DB) and 67°F wet bulb (WB), and outdoor ambient conditions of 95°F dry bulb (DB) and 75°F wet bulb (WB).

The shaded table columns and rows indicate reference data. When operating at this temperature, these values can be different if the system is not running consistently.

# PERFORMANCE DATA

MULTI F  
MULTI F MAX

## Cooling Capacity Tables

Table 128: LMU540HV Cooling Capacity Table — Non-Ducted (continued) / Ducted Indoor Units.

Combination Capacity Index (kBtu/h[%])	Outdoor Air Temp. (°F DB)	Indoor Air Temp. °F DB / °F WB											
		68 / 57		73 / 61		77 / 64		80 / 67		86 / 72		90 / 75	
		TC	PI	TC	PI	TC	PI	TC	PI	TC	PI	TC	PI
Non-Ducted Indoor Units 24 (40%)	14	22.87	0.97	24.29	1.01	25.71	1.04	26.74	1.05	28.55	1.07	29.97	1.10
	20	22.85	0.98	24.27	1.02	25.69	1.06	26.72	1.07	28.53	1.09	29.95	1.11
	25	22.84	1.00	24.25	1.03	25.67	1.07	26.70	1.08	28.51	1.10	29.93	1.13
	30	22.82	1.01	24.24	1.05	25.65	1.09	26.68	1.10	28.49	1.12	29.90	1.14
	35	22.80	1.03	24.22	1.06	25.63	1.10	26.66	1.11	28.46	1.14	29.88	1.16
	40	22.78	1.04	24.20	1.08	25.61	1.12	26.63	1.13	28.44	1.15	29.86	1.17
	45	22.77	1.05	24.18	1.09	25.59	1.13	26.61	1.14	28.42	1.17	29.83	1.19
	50	22.75	1.07	24.16	1.11	25.57	1.15	26.59	1.16	28.40	1.18	29.81	1.21
	55	22.73	1.08	24.14	1.12	25.55	1.16	26.57	1.18	28.38	1.20	29.79	1.22
	60	22.71	1.10	24.12	1.14	25.53	1.18	26.55	1.19	28.36	1.21	29.77	1.24
	65	22.70	1.11	24.11	1.15	25.51	1.19	26.53	1.21	28.33	1.23	29.74	1.25
	70	22.68	1.12	24.09	1.16	25.50	1.21	26.51	1.22	28.31	1.24	29.72	1.27
	75	22.13	1.18	23.54	1.23	24.94	1.27	25.96	1.29	27.75	1.31	29.16	1.34
	80	21.59	1.24	22.99	1.29	24.39	1.34	25.40	1.35	27.19	1.38	28.59	1.41
	85	21.05	1.31	22.44	1.35	23.84	1.40	24.85	1.42	26.64	1.44	28.04	1.47
	90	20.51	1.37	21.90	1.42	23.29	1.47	24.30	1.48	26.08	1.51	27.48	1.54
	95	19.92	1.43	21.31	1.48	22.69	1.53	<b>23.33</b>	<b>1.55</b>	25.47	1.58	26.86	1.61
	100	19.43	1.49	20.82	1.54	22.21	1.60	23.03	1.62	24.98	1.65	26.37	1.68
	105	18.95	1.55	20.34	1.60	21.72	1.66	22.73	1.68	24.50	1.71	25.89	1.75
	110	18.46	1.61	19.85	1.67	21.24	1.73	22.24	1.75	24.01	1.78	25.40	1.82
115	17.98	1.67	19.37	1.73	20.75	1.79	21.76	1.81	23.53	1.85	24.92	1.88	
118	17.69	1.71	19.07	1.77	20.46	1.83	21.46	1.85	23.24	1.89	24.63	1.93	
122	17.59	1.75	18.98	1.82	20.37	1.88	21.37	1.91	23.14	1.94	24.53	1.98	
Ducted Indoor Units 73 (135%)	14	52.99	3.55	56.29	3.68	59.58	3.82	61.95	3.86	66.16	3.94	69.45	4.01
	20	52.95	3.61	56.24	3.74	59.53	3.87	61.91	3.92	66.11	3.99	69.40	4.07
	25	52.91	3.66	56.20	3.79	59.49	3.93	61.86	3.97	66.06	4.05	69.35	4.13
	30	52.87	3.71	56.16	3.84	59.44	3.98	61.81	4.03	66.01	4.10	69.29	4.19
	35	52.83	3.76	56.11	3.90	59.40	4.04	61.77	4.08	65.96	4.16	69.24	4.25
	40	52.79	3.81	56.07	3.95	59.35	4.09	61.72	4.14	65.91	4.22	69.19	4.30
	45	52.75	3.86	56.03	4.00	59.30	4.15	61.67	4.20	65.86	4.27	69.13	4.36
	50	52.71	3.91	55.99	4.05	59.26	4.20	61.62	4.25	65.81	4.33	69.08	4.42
	55	52.67	3.96	55.94	4.11	59.21	4.26	61.58	4.31	65.76	4.39	69.03	4.48
	60	52.63	4.01	55.90	4.16	59.17	4.31	61.53	4.36	65.71	4.44	68.97	4.53
	65	52.59	4.07	55.86	4.21	59.12	4.37	61.48	4.42	65.66	4.50	68.92	4.59
	70	52.55	4.12	55.81	4.27	59.08	4.42	61.43	4.47	65.60	4.56	68.87	4.65
	75	51.29	4.34	54.54	4.50	57.80	4.66	60.15	4.71	64.31	4.80	67.56	4.90
	80	50.02	4.56	53.27	4.73	56.52	4.90	58.86	4.96	63.01	5.05	66.26	5.15
	85	48.77	4.78	52.01	4.96	55.25	5.14	57.59	5.20	61.73	5.29	64.97	5.40
	90	47.51	5.00	50.75	5.19	53.98	5.38	56.31	5.44	60.44	5.54	63.67	5.65
	95	46.15	5.23	49.37	5.42	52.58	5.62	<b>54.06</b>	<b>5.68</b>	59.02	5.79	62.23	5.90
	100	45.03	5.45	48.25	5.65	51.46	5.85	53.36	5.92	57.89	6.03	61.11	6.15
	105	43.91	5.67	47.12	5.88	50.34	6.09	52.66	6.16	56.77	6.28	59.98	6.40
	110	42.78	5.89	46.00	6.11	49.21	6.33	51.54	6.40	55.64	6.52	58.86	6.66
115	41.66	6.11	44.87	6.34	48.09	6.57	50.41	6.65	54.52	6.77	57.74	6.91	
118	40.98	6.25	44.20	6.48	47.41	6.71	49.74	6.79	53.85	6.92	57.06	7.06	
122	40.76	6.43	43.97	6.66	47.19	6.90	49.51	6.98	53.62	7.11	56.84	7.26	

TC = Total Capacity (kBtu/h).

PI = Power Input (kW).

Nominal capacity as rated: 0 ft. above sea level with Piping Length as Main Pipe (16.4 ft.) + Branch pipe (98.4 ft.) = 115 ft.  
0 ft. level difference between outdoor and indoor units.

Nominal cooling capacity rating obtained with air entering the indoor unit at 80°F dry bulb (DB) and 67°F wet bulb (WB), and outdoor ambient conditions of 95°F dry bulb (DB) and 75°F wet bulb (WB).

The shaded table columns and rows indicate reference data. When operating at this temperature, these values can be different if the system is not running consistently.



Multi F and Multi F MAX Heat Pump System Engineering Manual

Table 129: LMU540HV Cooling Capacity Table — Ducted Indoor Units (continued).

Combination Capacity Index (kBtu/h[%])	Outdoor Air Temp. (°F DB)	Indoor Air Temp. °F DB / °F WB											
		68 / 57		73 / 61		77 / 64		80 / 67		86 / 72		90 / 75	
		TC	PI	TC	PI	TC	PI	TC	PI	TC	PI	TC	PI
Ducted Indoor Units 70 (130%)	14	52.52	3.50	55.79	3.63	59.05	3.76	61.40	3.80	65.57	3.87	68.83	3.95
	20	52.48	3.55	55.74	3.68	59.00	3.81	61.36	3.86	65.52	3.93	68.78	4.01
	25	52.44	3.60	55.70	3.73	58.96	3.87	61.31	3.91	65.47	3.98	68.73	4.06
	30	52.40	3.65	55.66	3.78	58.91	3.92	61.26	3.97	65.42	4.04	68.68	4.12
	35	52.36	3.70	55.62	3.83	58.87	3.97	61.22	4.02	65.37	4.10	68.62	4.18
	40	52.32	3.75	55.57	3.89	58.82	4.03	61.17	4.07	65.32	4.15	68.57	4.23
	45	52.28	3.80	55.53	3.94	58.78	4.08	61.12	4.13	65.27	4.21	68.52	4.29
	50	52.24	3.85	55.49	3.99	58.73	4.14	61.08	4.18	65.22	4.26	68.47	4.35
	55	52.20	3.90	55.45	4.04	58.69	4.19	61.03	4.24	65.17	4.32	68.41	4.40
	60	52.16	3.95	55.40	4.09	58.64	4.24	60.98	4.29	65.12	4.37	68.36	4.46
	65	52.12	4.00	55.36	4.15	58.60	4.30	60.94	4.35	65.07	4.43	68.31	4.52
	70	52.08	4.05	55.32	4.20	58.55	4.35	60.89	4.40	65.02	4.48	68.26	4.58
	75	50.83	4.27	54.06	4.43	57.28	4.59	59.61	4.64	63.74	4.73	66.96	4.82
	80	49.58	4.49	52.80	4.65	56.01	4.82	58.34	4.88	62.45	4.97	65.67	5.07
	85	48.33	4.71	51.55	4.88	54.76	5.06	57.08	5.11	61.18	5.21	64.39	5.32
	90	47.09	4.93	50.30	5.11	53.50	5.29	55.81	5.35	59.90	5.45	63.11	5.56
	95	45.74	5.14	48.93	5.33	52.12	5.53	<b>53.58</b>	<b>5.59</b>	58.49	5.69	61.68	5.81
	100	44.63	5.36	47.82	5.56	51.00	5.76	52.89	5.83	57.38	5.94	60.56	6.06
	105	43.52	5.58	46.70	5.78	49.89	6.00	52.19	6.07	56.26	6.18	59.45	6.30
	110	42.40	5.80	45.59	6.01	48.78	6.23	51.08	6.30	55.15	6.42	58.34	6.55
115	41.29	6.02	44.48	6.24	47.66	6.47	49.96	6.54	54.04	6.66	57.22	6.80	
118	40.62	6.15	43.81	6.37	46.99	6.61	49.30	6.68	53.37	6.81	56.55	6.94	
122	40.40	6.32	43.58	6.55	46.77	6.79	49.07	6.87	53.14	7.00	56.33	7.14	
Ducted Indoor Units 65 (120%)	14	51.73	3.40	54.94	3.53	58.16	3.66	60.48	3.70	64.58	3.77	67.79	3.84
	20	51.69	3.45	54.90	3.58	58.11	3.71	60.43	3.75	64.53	3.82	67.74	3.90
	25	51.65	3.50	54.86	3.63	58.07	3.76	60.38	3.81	64.48	3.88	67.69	3.96
	30	51.61	3.55	54.82	3.68	58.02	3.82	60.34	3.86	64.43	3.93	67.64	4.01
	35	51.57	3.60	54.78	3.73	57.98	3.87	60.29	3.91	64.38	3.99	67.59	4.07
	40	51.53	3.65	54.73	3.78	57.93	3.92	60.25	3.97	64.33	4.04	67.54	4.12
	45	51.49	3.70	54.69	3.83	57.89	3.97	60.20	4.02	64.29	4.09	67.48	4.18
	50	51.45	3.75	54.65	3.88	57.85	4.03	60.15	4.07	64.24	4.15	67.43	4.23
	55	51.41	3.80	54.61	3.93	57.80	4.08	60.11	4.12	64.19	4.20	67.38	4.29
	60	51.38	3.84	54.57	3.98	57.76	4.13	60.06	4.18	64.14	4.26	67.33	4.34
	65	51.34	3.89	54.52	4.04	57.71	4.18	60.01	4.23	64.09	4.31	67.28	4.40
	70	51.30	3.94	54.48	4.09	57.67	4.24	59.97	4.28	64.04	4.36	67.22	4.45
	75	50.06	4.16	53.24	4.31	56.42	4.46	58.71	4.52	62.77	4.60	65.95	4.69
	80	48.83	4.37	52.00	4.53	55.17	4.69	57.46	4.75	61.51	4.84	64.68	4.93
	85	47.60	4.58	50.77	4.75	53.93	4.92	56.21	4.98	60.25	5.07	63.41	5.17
	90	46.38	4.79	49.53	4.97	52.69	5.15	54.97	5.21	59.00	5.31	62.15	5.41
	95	45.05	5.01	48.19	5.19	51.33	5.38	<b>52.77</b>	<b>5.44</b>	57.61	5.54	60.75	5.65
	100	43.96	5.22	47.09	5.41	50.23	5.61	52.09	5.67	56.51	5.78	59.65	5.89
	105	42.86	5.43	46.00	5.63	49.14	5.84	51.40	5.90	55.41	6.01	58.55	6.13
	110	41.76	5.64	44.90	5.85	48.04	6.06	50.31	6.13	54.32	6.25	57.45	6.37
115	40.66	5.86	43.80	6.07	46.94	6.29	49.21	6.36	53.22	6.48	56.36	6.61	
118	40.01	5.98	43.14	6.20	46.28	6.43	48.55	6.50	52.56	6.63	55.70	6.76	
122	39.79	6.15	42.93	6.38	46.06	6.61	48.33	6.69	52.34	6.81	55.48	6.95	

TC = Total Capacity (kBtu/h).

PI = Power Input (kW).

Nominal capacity as rated: 0 ft. above sea level with Piping Length as Main Pipe (16.4 ft.) + Branch pipe (98.4 ft.) = 115 ft.  
0 ft. level difference between outdoor and indoor units.

Nominal cooling capacity rating obtained with air entering the indoor unit at 80°F dry bulb (DB) and 67°F wet bulb (WB), and outdoor ambient conditions of 95°F dry bulb (DB) and 75°F wet bulb (WB).

The shaded table columns and rows indicate reference data. When operating at this temperature, these values can be different if the system is not running consistently.

# PERFORMANCE DATA

## Cooling Capacity Tables

MULTI F  
MULTI F MAX

Table 130: LMU540HV Cooling Capacity Table — Ducted Indoor Units (continued).

Combination Capacity Index (kBtu/h[%])	Outdoor Air Temp. (°F DB)	Indoor Air Temp. °F DB / °F WB											
		68 / 57		73 / 61		77 / 64		80 / 67		86 / 72		90 / 75	
		TC	PI	TC	PI	TC	PI	TC	PI	TC	PI	TC	PI
Ducted Indoor Units 59 (110%)	14	50.79	3.29	53.94	3.41	57.10	3.53	59.38	3.57	63.41	3.64	66.56	3.71
	20	50.75	3.33	53.90	3.45	57.05	3.58	59.33	3.62	63.36	3.69	66.51	3.76
	25	50.71	3.38	53.86	3.50	57.01	3.63	59.29	3.67	63.31	3.74	66.46	3.82
	30	50.67	3.43	53.82	3.55	56.97	3.68	59.24	3.72	63.26	3.79	66.41	3.87
	35	50.63	3.47	53.78	3.60	56.92	3.73	59.19	3.78	63.21	3.85	66.36	3.92
	40	50.60	3.52	53.74	3.65	56.88	3.78	59.15	3.83	63.16	3.90	66.31	3.98
	45	50.56	3.57	53.70	3.70	56.84	3.83	59.10	3.88	63.12	3.95	66.26	4.03
	50	50.52	3.62	53.66	3.75	56.79	3.88	59.06	3.93	63.07	4.00	66.21	4.08
	55	50.48	3.66	53.61	3.80	56.75	3.94	59.01	3.98	63.02	4.06	66.15	4.14
	60	50.44	3.71	53.57	3.85	56.71	3.99	58.97	4.03	62.97	4.11	66.10	4.19
	65	50.40	3.76	53.53	3.89	56.66	4.04	58.92	4.08	62.92	4.16	66.05	4.24
	70	50.36	3.80	53.49	3.94	56.62	4.09	58.88	4.13	62.87	4.21	66.00	4.30
	75	49.15	4.01	52.27	4.16	55.39	4.31	57.64	4.36	61.63	4.44	64.75	4.53
	80	47.94	4.22	51.05	4.37	54.16	4.53	56.41	4.58	60.39	4.67	63.50	4.76
	85	46.74	4.42	49.84	4.58	52.95	4.75	55.19	4.80	59.16	4.89	62.26	4.99
	90	45.54	4.63	48.63	4.79	51.73	4.97	53.97	5.03	57.92	5.12	61.02	5.22
	95	44.23	4.83	47.31	5.01	50.40	5.19	51.81	5.25	56.56	5.35	59.64	5.46
	100	43.16	5.04	46.24	5.22	49.32	5.41	51.14	5.47	55.48	5.58	58.56	5.69
	105	42.08	5.24	45.16	5.43	48.24	5.63	50.47	5.70	54.41	5.80	57.49	5.92
	110	41.00	5.45	44.08	5.65	47.16	5.85	49.39	5.92	53.33	6.03	56.41	6.15
115	39.92	5.65	43.01	5.86	46.09	6.07	48.31	6.14	52.25	6.26	55.33	6.38	
118	39.28	5.78	42.36	5.99	45.44	6.20	47.67	6.28	51.60	6.39	54.69	6.52	
122	39.06	5.94	42.14	6.16	45.23	6.38	47.45	6.45	51.39	6.58	54.47	6.71	
Ducted Indoor Units 54 (100%)	14	50.00	3.19	53.10	3.31	56.21	3.43	58.45	3.47	62.41	3.53	65.52	3.60
	20	49.96	3.24	53.06	3.36	56.16	3.48	58.40	3.52	62.37	3.58	65.47	3.66
	25	49.92	3.28	53.02	3.40	56.12	3.53	58.36	3.57	62.32	3.63	65.42	3.71
	30	49.88	3.33	52.98	3.45	56.08	3.58	58.31	3.62	62.27	3.69	65.37	3.76
	35	49.84	3.38	52.94	3.50	56.03	3.63	58.27	3.67	62.22	3.74	65.32	3.81
	40	49.80	3.42	52.90	3.55	55.99	3.68	58.22	3.72	62.18	3.79	65.27	3.86
	45	49.77	3.47	52.86	3.59	55.95	3.72	58.18	3.77	62.13	3.84	65.22	3.92
	50	49.73	3.51	52.82	3.64	55.90	3.77	58.14	3.82	62.08	3.89	65.17	3.97
	55	49.69	3.56	52.78	3.69	55.86	3.82	58.09	3.87	62.03	3.94	65.12	4.02
	60	49.65	3.60	52.74	3.74	55.82	3.87	58.05	3.92	61.99	3.99	65.07	4.07
	65	49.61	3.65	52.70	3.78	55.78	3.92	58.00	3.97	61.94	4.04	65.02	4.12
	70	49.58	3.70	52.65	3.83	55.73	3.97	57.96	4.02	61.89	4.09	64.97	4.17
	75	48.38	3.90	51.45	4.04	54.53	4.19	56.74	4.23	60.67	4.31	63.74	4.40
	80	47.19	4.09	50.25	4.24	53.32	4.40	55.53	4.45	59.44	4.53	62.51	4.62
	85	46.01	4.29	49.06	4.45	52.12	4.61	54.33	4.67	58.23	4.75	61.29	4.85
	90	44.82	4.49	47.87	4.66	50.92	4.83	53.12	4.88	57.02	4.97	60.07	5.07
	95	43.54	4.69	46.57	4.86	49.61	5.04	51.00	5.10	55.68	5.20	58.71	5.30
	100	42.48	4.89	45.51	5.07	48.55	5.26	50.34	5.32	54.61	5.42	57.65	5.53
	105	41.42	5.09	44.45	5.28	47.49	5.47	49.68	5.53	53.55	5.64	56.59	5.75
	110	40.36	5.29	43.39	5.48	46.43	5.68	48.62	5.75	52.49	5.86	55.53	5.98
115	39.30	5.49	42.33	5.69	45.37	5.90	47.56	5.97	51.43	6.08	54.47	6.20	
118	38.66	5.61	41.70	5.82	44.73	6.03	46.92	6.10	50.80	6.21	53.83	6.34	
122	38.45	5.77	41.49	5.98	44.52	6.20	46.71	6.27	50.59	6.39	53.62	6.52	

TC = Total Capacity (kBtu/h).

PI = Power Input (kW).

Nominal capacity as rated: 0 ft. above sea level with Piping Length as Main Pipe (16.4 ft.) + Branch pipe (98.4 ft.) = 115 ft.  
0 ft. level difference between outdoor and indoor units.

Nominal cooling capacity rating obtained with air entering the indoor unit at 80°F dry bulb (DB) and 67°F wet bulb (WB), and outdoor ambient conditions of 95°F dry bulb (DB) and 75°F wet bulb (WB).

The shaded table columns and rows indicate reference data. When operating at this temperature, these values can be different if the system is not running consistently.



Multi F and Multi F MAX Heat Pump System Engineering Manual

Table 131: LMU540HV Cooling Capacity Table — Ducted Indoor Units (continued).

Combination Capacity Index (kBtu/h[%])	Outdoor Air Temp. (°F DB)	Indoor Air Temp. °F DB / °F WB											
		68 / 57		73 / 61		77 / 64		80 / 67		86 / 72		90 / 75	
		TC	PI	TC	PI	TC	PI	TC	PI	TC	PI	TC	PI
Ducted Indoor Units 49 (90%)	14	45.37	2.82	48.19	2.93	51.00	3.03	53.04	3.07	56.64	3.12	59.46	3.19
	20	45.33	2.86	48.15	2.97	50.96	3.08	53.00	3.11	56.60	3.17	59.41	3.23
	25	45.30	2.90	48.11	3.01	50.93	3.12	52.96	3.16	56.55	3.21	59.37	3.28
	30	45.26	2.94	48.08	3.05	50.89	3.16	52.92	3.20	56.51	3.26	59.32	3.32
	35	45.23	2.98	48.04	3.09	50.85	3.21	52.88	3.24	56.47	3.30	59.27	3.37
	40	45.20	3.03	48.00	3.14	50.81	3.25	52.84	3.29	56.42	3.35	59.23	3.42
	45	45.16	3.07	47.97	3.18	50.77	3.29	52.80	3.33	56.38	3.39	59.18	3.46
	50	45.13	3.11	47.93	3.22	50.73	3.34	52.76	3.38	56.34	3.44	59.14	3.51
	55	45.09	3.15	47.89	3.26	50.69	3.38	52.71	3.42	56.29	3.48	59.09	3.55
	60	45.06	3.19	47.85	3.30	50.65	3.42	52.67	3.46	56.25	3.53	59.05	3.60
	65	45.02	3.23	47.82	3.35	50.61	3.47	52.63	3.51	56.21	3.57	59.00	3.65
	70	44.99	3.27	47.78	3.39	50.58	3.51	52.59	3.55	56.16	3.62	58.96	3.69
	75	43.90	3.44	46.69	3.57	49.48	3.70	51.49	3.74	55.05	3.81	57.84	3.89
	80	42.82	3.62	45.60	3.75	48.38	3.89	50.39	3.94	53.94	4.01	56.72	4.09
	85	41.75	3.80	44.52	3.94	47.30	4.08	49.30	4.13	52.84	4.20	55.62	4.29
	90	40.68	3.97	43.44	4.12	46.21	4.27	48.21	4.32	51.74	4.40	54.51	4.49
	95	39.51	4.15	42.26	4.30	45.02	4.46	<b>46.28</b>	<b>4.51</b>	50.52	4.59	53.28	4.69
	100	38.55	4.33	41.30	4.48	44.05	4.65	45.68	4.70	49.56	4.79	52.31	4.89
	105	37.59	4.50	40.34	4.67	43.09	4.84	45.08	4.89	48.60	4.98	51.35	5.09
	110	36.63	4.68	39.38	4.85	42.13	5.03	44.12	5.08	47.64	5.18	50.39	5.28
115	35.66	4.86	38.42	5.03	41.17	5.22	43.16	5.28	46.67	5.38	49.43	5.48	
118	35.09	4.96	37.84	5.14	40.59	5.33	42.58	5.39	46.10	5.49	48.85	5.60	
122	34.89	5.10	37.65	5.29	40.40	5.48	42.39	5.54	45.90	5.65	48.66	5.76	
Ducted Indoor Units 43 (80%)	14	39.81	2.38	42.28	2.46	44.75	2.55	46.54	2.58	49.70	2.63	52.17	2.69
	20	39.78	2.41	42.25	2.50	44.72	2.59	46.50	2.62	49.66	2.67	52.13	2.72
	25	39.75	2.45	42.22	2.54	44.69	2.63	46.47	2.66	49.62	2.71	52.09	2.76
	30	39.72	2.48	42.19	2.57	44.65	2.66	46.43	2.70	49.59	2.75	52.05	2.80
	35	39.69	2.51	42.15	2.61	44.62	2.70	46.40	2.73	49.55	2.78	52.01	2.84
	40	39.66	2.55	42.12	2.64	44.58	2.74	46.36	2.77	49.51	2.82	51.97	2.88
	45	39.63	2.58	42.09	2.68	44.55	2.78	46.33	2.81	49.47	2.86	51.93	2.92
	50	39.60	2.62	42.06	2.71	44.52	2.81	46.29	2.84	49.43	2.90	51.89	2.96
	55	39.57	2.65	42.02	2.75	44.48	2.85	46.26	2.88	49.40	2.94	51.85	2.99
	60	39.54	2.69	41.99	2.78	44.45	2.89	46.22	2.92	49.36	2.97	51.81	3.03
	65	39.51	2.72	41.96	2.82	44.41	2.92	46.19	2.96	49.32	3.01	51.77	3.07
	70	39.48	2.75	41.93	2.85	44.38	2.96	46.15	2.99	49.28	3.05	51.73	3.11
	75	38.53	2.90	40.97	3.01	43.42	3.12	45.18	3.15	48.31	3.21	50.75	3.28
	80	37.58	3.05	40.02	3.16	42.46	3.28	44.22	3.32	47.33	3.38	49.77	3.45
	85	36.63	3.20	39.07	3.32	41.50	3.44	43.26	3.48	46.37	3.54	48.80	3.61
	90	35.69	3.35	38.12	3.47	40.55	3.60	42.30	3.64	45.40	3.71	47.83	3.78
	95	34.67	3.50	37.09	3.62	39.50	3.76	<b>40.61</b>	<b>3.80</b>	44.33	3.87	46.75	3.95
	100	33.83	3.65	36.24	3.78	38.66	3.92	40.08	3.96	43.49	4.04	45.90	4.12
	105	32.98	3.79	35.40	3.93	37.81	4.08	39.56	4.12	42.64	4.20	45.06	4.28
	110	32.14	3.94	34.55	4.09	36.97	4.24	38.71	4.28	41.80	4.36	44.22	4.45
115	31.29	4.09	33.71	4.24	36.12	4.40	37.87	4.45	40.96	4.53	43.37	4.62	
118	30.79	4.18	33.20	4.33	35.62	4.49	37.36	4.54	40.45	4.63	42.86	4.72	
122	30.62	4.30	33.03	4.46	35.45	4.62	37.19	4.67	40.28	4.76	42.70	4.86	

TC = Total Capacity (kBtu/h).

PI = Power Input (kW).

Nominal capacity as rated: 0 ft. above sea level with Piping Length as Main Pipe (16.4 ft.) + Branch pipe (98.4 ft.) = 115 ft.  
0 ft. level difference between outdoor and indoor units.

Nominal cooling capacity rating obtained with air entering the indoor unit at 80°F dry bulb (DB) and 67°F wet bulb (WB), and outdoor ambient conditions of 95°F dry bulb (DB) and 75°F wet bulb (WB).

The shaded table columns and rows indicate reference data. When operating at this temperature, these values can be different if the system is not running consistently.

# PERFORMANCE DATA

## Cooling Capacity Tables

MULTI F  
MULTI F MAX

Table 132: LMU540HV Cooling Capacity Table — Ducted Indoor Units (continued).

Combination Capacity Index (kBtu/h[%])	Outdoor Air Temp. (°F DB)	Indoor Air Temp. °F DB / °F WB											
		68 / 57		73 / 61		77 / 64		80 / 67		86 / 72		90 / 75	
		TC	PI	TC	PI	TC	PI	TC	PI	TC	PI	TC	PI
Ducted Indoor Units 38 (70%)	14	35.18	2.01	37.37	2.08	39.55	2.16	41.13	2.18	43.92	2.22	46.11	2.27
	20	35.16	2.04	37.34	2.11	39.52	2.19	41.10	2.21	43.89	2.26	46.07	2.30
	25	35.13	2.07	37.31	2.14	39.49	2.22	41.07	2.25	43.86	2.29	46.04	2.33
	30	35.10	2.10	37.28	2.17	39.46	2.25	41.04	2.28	43.82	2.32	46.00	2.37
	35	35.08	2.12	37.25	2.20	39.43	2.28	41.01	2.31	43.79	2.35	45.97	2.40
	40	35.05	2.15	37.23	2.23	39.40	2.31	40.97	2.34	43.76	2.38	45.93	2.43
	45	35.02	2.18	37.20	2.26	39.37	2.34	40.94	2.37	43.72	2.42	45.90	2.46
	50	35.00	2.21	37.17	2.29	39.34	2.38	40.91	2.40	43.69	2.45	45.86	2.50
	55	34.97	2.24	37.14	2.32	39.31	2.41	40.88	2.43	43.65	2.48	45.83	2.53
	60	34.94	2.27	37.11	2.35	39.28	2.44	40.85	2.47	43.62	2.51	45.79	2.56
	65	34.91	2.30	37.08	2.38	39.25	2.47	40.82	2.50	43.59	2.54	45.76	2.59
	70	34.89	2.33	37.05	2.41	39.22	2.50	40.79	2.53	43.55	2.58	45.72	2.63
	75	34.05	2.45	36.21	2.54	38.37	2.63	39.93	2.66	42.69	2.71	44.85	2.77
	80	33.21	2.58	35.36	2.67	37.52	2.77	39.08	2.80	41.83	2.85	43.99	2.91
	85	32.38	2.70	34.53	2.80	36.68	2.90	38.23	2.94	40.98	2.99	43.13	3.05
	90	31.54	2.83	33.69	2.93	35.84	3.04	37.38	3.07	40.13	3.13	42.27	3.19
	95	30.64	2.95	32.78	3.06	34.91	3.17	<b>35.89</b>	<b>3.21</b>	39.18	3.27	41.31	3.34
	100	29.90	3.08	32.03	3.19	34.16	3.31	35.43	3.35	38.43	3.41	40.57	3.48
	105	29.15	3.20	31.28	3.32	33.42	3.44	34.96	3.48	37.69	3.55	39.82	3.62
	110	28.40	3.33	30.54	3.45	32.67	3.58	34.21	3.62	36.94	3.69	39.08	3.76
115	27.66	3.46	29.79	3.58	31.93	3.71	33.47	3.76	36.20	3.83	38.33	3.90	
118	27.21	3.53	29.34	3.66	31.48	3.79	33.02	3.84	35.75	3.91	37.88	3.99	
122	27.06	3.63	29.19	3.76	31.33	3.90	32.87	3.95	35.60	4.02	37.73	4.10	
Ducted Indoor Units 32 (60%)	14	29.62	1.56	31.46	1.62	33.30	1.68	34.63	1.70	36.98	1.73	38.82	1.77
	20	29.60	1.59	31.44	1.64	33.28	1.70	34.61	1.72	36.96	1.76	38.79	1.79
	25	29.58	1.61	31.42	1.67	33.25	1.73	34.58	1.75	36.93	1.78	38.76	1.82
	30	29.56	1.63	31.39	1.69	33.23	1.75	34.55	1.77	36.90	1.81	38.73	1.84
	35	29.53	1.65	31.37	1.71	33.20	1.78	34.53	1.80	36.87	1.83	38.71	1.87
	40	29.51	1.68	31.34	1.74	33.18	1.80	34.50	1.82	36.84	1.86	38.68	1.89
	45	29.49	1.70	31.32	1.76	33.15	1.83	34.47	1.85	36.81	1.88	38.65	1.92
	50	29.47	1.72	31.30	1.78	33.13	1.85	34.45	1.87	36.79	1.91	38.62	1.94
	55	29.44	1.74	31.27	1.81	33.10	1.87	34.42	1.90	36.76	1.93	38.59	1.97
	60	29.42	1.77	31.25	1.83	33.08	1.90	34.40	1.92	36.73	1.96	38.56	2.00
	65	29.40	1.79	31.22	1.85	33.05	1.92	34.37	1.94	36.70	1.98	38.53	2.02
	70	29.38	1.81	31.20	1.88	33.02	1.95	34.34	1.97	36.67	2.01	38.50	2.05
	75	28.67	1.91	30.49	1.98	32.31	2.05	33.62	2.08	35.95	2.11	37.77	2.16
	80	27.96	2.01	29.78	2.08	31.59	2.16	32.90	2.18	35.22	2.22	37.04	2.27
	85	27.26	2.10	29.07	2.18	30.88	2.26	32.19	2.29	34.51	2.33	36.32	2.38
	90	26.56	2.20	28.37	2.28	30.17	2.37	31.48	2.39	33.79	2.44	35.59	2.49
	95	25.80	2.30	27.60	2.38	29.40	2.47	<b>30.22</b>	<b>2.50</b>	32.99	2.55	34.79	2.60
	100	25.17	2.40	26.97	2.49	28.77	2.58	29.83	2.61	32.36	2.66	34.16	2.71
	105	24.54	2.50	26.34	2.59	28.14	2.68	29.44	2.71	31.73	2.76	33.53	2.82
	110	23.92	2.59	25.71	2.69	27.51	2.79	28.81	2.82	31.11	2.87	32.90	2.93
115	23.29	2.69	25.08	2.79	26.88	2.89	28.18	2.92	30.48	2.98	32.27	3.04	
118	22.91	2.75	24.71	2.85	26.51	2.95	27.80	2.99	30.10	3.04	31.90	3.11	
122	22.78	2.83	24.58	2.93	26.38	3.04	27.68	3.07	29.97	3.13	31.77	3.19	

TC = Total Capacity (kBtu/h).

PI = Power Input (kW).

Nominal capacity as rated: 0 ft. above sea level with Piping Length as Main Pipe (16.4 ft.) + Branch pipe (98.4 ft.) = 115 ft.  
0 ft. level difference between outdoor and indoor units.

Nominal cooling capacity rating obtained with air entering the indoor unit at 80°F dry bulb (DB) and 67°F wet bulb (WB), and outdoor ambient conditions of 95°F dry bulb (DB) and 75°F wet bulb (WB).

The shaded table columns and rows indicate reference data. When operating at this temperature, these values can be different if the system is not running consistently.



Multi F and Multi F MAX Heat Pump System Engineering Manual

Table 133: LMU540HV Cooling Capacity Table — Ducted Indoor Units (continued).

Combination Capacity Index (kBtu/h[%])	Outdoor Air Temp. (°F DB)	Indoor Air Temp. °F DB / °F WB											
		68 / 57		73 / 61		77 / 64		80 / 67		86 / 72		90 / 75	
		TC	PI	TC	PI	TC	PI	TC	PI	TC	PI	TC	PI
Ducted Indoor Units 27 (50%)	14	25.00	1.20	26.55	1.24	28.10	1.28	29.22	1.30	31.21	1.32	32.76	1.35
	20	24.98	1.21	26.53	1.26	28.08	1.30	29.20	1.32	31.18	1.34	32.73	1.37
	25	24.96	1.23	26.51	1.27	28.06	1.32	29.18	1.34	31.16	1.36	32.71	1.39
	30	24.94	1.25	26.49	1.29	28.04	1.34	29.16	1.35	31.14	1.38	32.68	1.41
	35	24.92	1.26	26.47	1.31	28.02	1.36	29.13	1.37	31.11	1.40	32.66	1.43
	40	24.90	1.28	26.45	1.33	28.00	1.38	29.11	1.39	31.09	1.42	32.63	1.45
	45	24.88	1.30	26.43	1.35	27.97	1.39	29.09	1.41	31.06	1.44	32.61	1.47
	50	24.86	1.32	26.41	1.36	27.95	1.41	29.07	1.43	31.04	1.46	32.58	1.49
	55	24.85	1.33	26.39	1.38	27.93	1.43	29.05	1.45	31.02	1.48	32.56	1.51
	60	24.83	1.35	26.37	1.40	27.91	1.45	29.02	1.47	30.99	1.49	32.54	1.52
	65	24.81	1.37	26.35	1.42	27.89	1.47	29.00	1.49	30.97	1.51	32.51	1.54
	70	24.79	1.38	26.33	1.43	27.87	1.49	28.98	1.50	30.95	1.53	32.49	1.56
	75	24.19	1.46	25.73	1.51	27.26	1.57	28.37	1.59	30.33	1.62	31.87	1.65
	80	23.59	1.53	25.13	1.59	26.66	1.65	27.76	1.67	29.72	1.70	31.25	1.73
	85	23.00	1.61	24.53	1.67	26.06	1.73	27.16	1.75	29.12	1.78	30.64	1.82
	90	22.41	1.68	23.94	1.74	25.46	1.81	26.56	1.83	28.51	1.86	30.03	1.90
	95	21.77	1.76	23.29	1.82	24.80	1.89	<b>25.50</b>	<b>1.91</b>	27.84	1.95	29.35	1.98
	100	21.24	1.83	22.76	1.90	24.27	1.97	25.17	1.99	27.31	2.03	28.82	2.07
	105	20.71	1.91	22.23	1.98	23.74	2.05	24.84	2.07	26.78	2.11	28.29	2.15
	110	20.18	1.98	21.70	2.05	23.21	2.13	24.31	2.15	26.25	2.19	27.76	2.24
115	19.65	2.06	21.17	2.13	22.68	2.21	23.78	2.23	25.72	2.28	27.23	2.32	
118	19.33	2.10	20.85	2.18	22.37	2.26	23.46	2.28	25.40	2.33	26.92	2.37	
122	19.23	2.16	20.74	2.24	22.26	2.32	23.35	2.35	25.29	2.39	26.81	2.44	
Ducted Indoor Units 24 (40%)	14	22.22	0.97	23.60	1.01	24.98	1.04	25.98	1.05	27.74	1.07	29.12	1.10
	20	22.21	0.98	23.59	1.02	24.96	1.06	25.96	1.07	27.72	1.09	29.10	1.11
	25	22.19	1.00	23.57	1.03	24.95	1.07	25.94	1.08	27.70	1.10	29.08	1.13
	30	22.17	1.01	23.55	1.05	24.93	1.09	25.92	1.10	27.68	1.12	29.06	1.14
	35	22.16	1.03	23.53	1.06	24.91	1.10	25.90	1.11	27.66	1.14	29.04	1.16
	40	22.14	1.04	23.51	1.08	24.89	1.12	25.88	1.13	27.64	1.15	29.01	1.17
	45	22.12	1.05	23.50	1.09	24.87	1.13	25.86	1.14	27.62	1.17	28.99	1.19
	50	22.10	1.07	23.48	1.11	24.85	1.15	25.84	1.16	27.60	1.18	28.97	1.21
	55	22.09	1.08	23.46	1.12	24.83	1.16	25.82	1.18	27.57	1.20	28.95	1.22
	60	22.07	1.10	23.44	1.14	24.81	1.18	25.80	1.19	27.55	1.21	28.92	1.24
	65	22.05	1.11	23.42	1.15	24.79	1.19	25.78	1.21	27.53	1.23	28.90	1.25
	70	22.04	1.12	23.41	1.16	24.77	1.21	25.76	1.22	27.51	1.24	28.88	1.27
	75	21.51	1.18	22.87	1.23	24.24	1.27	25.22	1.29	26.97	1.31	28.33	1.34
	80	20.98	1.24	22.34	1.29	23.70	1.34	24.68	1.35	26.42	1.38	27.79	1.41
	85	20.45	1.31	21.81	1.35	23.17	1.40	24.15	1.42	25.88	1.44	27.24	1.47
	90	19.93	1.37	21.28	1.42	22.64	1.47	23.61	1.48	25.35	1.51	26.70	1.54
	95	19.35	1.43	20.70	1.48	22.05	1.53	<b>22.67</b>	<b>1.55</b>	24.75	1.58	26.10	1.61
	100	18.88	1.49	20.23	1.54	21.58	1.60	22.38	1.62	24.28	1.65	25.63	1.68
	105	18.41	1.55	19.76	1.60	21.11	1.66	22.08	1.68	23.81	1.71	25.15	1.75
	110	17.94	1.61	19.29	1.67	20.64	1.73	21.61	1.75	23.33	1.78	24.68	1.82
115	17.47	1.67	18.82	1.73	20.17	1.79	21.14	1.81	22.86	1.85	24.21	1.88	
118	17.19	1.71	18.53	1.77	19.88	1.83	20.86	1.85	22.58	1.89	23.93	1.93	
122	17.09	1.75	18.44	1.82	19.79	1.88	20.76	1.91	22.49	1.94	23.83	1.98	

TC = Total Capacity (kBtu/h).

PI = Power Input (kW).

Nominal capacity as rated: 0 ft. above sea level with Piping Length as Main Pipe (16.4 ft.) + Branch pipe (98.4 ft.) = 115 ft.  
0 ft. level difference between outdoor and indoor units.

Nominal cooling capacity rating obtained with air entering the indoor unit at 80°F dry bulb (DB) and 67°F wet bulb (WB), and outdoor ambient conditions of 95°F dry bulb (DB) and 75°F wet bulb (WB).

The shaded table columns and rows indicate reference data. When operating at this temperature, these values can be different if the system is not running consistently.

# PERFORMANCE DATA

MULTI F  
MULTI F MAX

## Cooling Capacity Tables

Table 134: LMU540HV Cooling Capacity Table — Mixed Indoor Units.

Combination Capacity Index (kBtu/h[%])	Outdoor Air Temp. (°F DB)	Indoor Air Temp. °F DB / °F WB											
		68 / 57		73 / 61		77 / 64		80 / 67		86 / 72		90 / 75	
		TC	PI	TC	PI	TC	PI	TC	PI	TC	PI	TC	PI
Mixed Indoor Units 73 (135%)	14	53.78	3.55	57.12	3.68	60.46	3.82	62.87	3.86	67.14	3.94	70.48	4.01
	20	53.74	3.61	57.08	3.74	60.41	3.87	62.82	3.92	67.09	3.99	70.43	4.07
	25	53.70	3.66	57.03	3.79	60.37	3.93	62.78	3.97	67.04	4.05	70.37	4.13
	30	53.66	3.71	56.99	3.84	60.32	3.98	62.73	4.03	66.99	4.10	70.32	4.19
	35	53.62	3.76	56.94	3.90	60.27	4.04	62.68	4.08	66.93	4.16	70.26	4.25
	40	53.57	3.81	56.90	3.95	60.23	4.09	62.63	4.14	66.88	4.22	70.21	4.30
	45	53.53	3.86	56.86	4.00	60.18	4.15	62.58	4.20	66.83	4.27	70.16	4.36
	50	53.49	3.91	56.81	4.05	60.14	4.20	62.54	4.25	66.78	4.33	70.10	4.42
	55	53.45	3.96	56.77	4.11	60.09	4.26	62.49	4.31	66.73	4.39	70.05	4.48
	60	53.41	4.01	56.73	4.16	60.04	4.31	62.44	4.36	66.68	4.44	69.99	4.53
	65	53.37	4.07	56.68	4.21	60.00	4.37	62.39	4.42	66.63	4.50	69.94	4.59
	70	53.33	4.12	56.64	4.27	59.95	4.42	62.34	4.47	66.58	4.56	69.89	4.65
	75	52.04	4.34	55.35	4.50	58.65	4.66	61.04	4.71	65.26	4.80	68.56	4.90
	80	50.76	4.56	54.06	4.73	57.35	4.90	59.73	4.96	63.94	5.05	67.24	5.15
	85	49.49	4.78	52.78	4.96	56.06	5.14	58.44	5.20	62.64	5.29	65.93	5.40
	90	48.22	5.00	51.50	5.19	54.78	5.38	57.14	5.44	61.33	5.54	64.61	5.65
	95	46.84	5.23	50.10	5.42	53.36	5.62	<b>54.86</b>	<b>5.68</b>	59.89	5.79	63.15	5.90
	100	45.70	5.45	48.96	5.65	52.22	5.85	54.15	5.92	58.75	6.03	62.01	6.15
	105	44.56	5.67	47.82	5.88	51.08	6.09	53.44	6.16	57.61	6.28	60.87	6.40
	110	43.42	5.89	46.68	6.11	49.94	6.33	52.30	6.40	56.47	6.42	59.73	6.66
115	42.27	6.11	45.54	6.34	48.80	6.57	51.16	6.65	55.33	6.77	58.59	6.91	
118	41.59	6.25	44.85	6.48	48.12	6.71	50.47	6.79	54.64	6.92	57.91	7.06	
122	41.36	6.43	44.63	6.66	47.89	6.90	50.24	6.98	54.41	7.11	57.68	7.26	
Mixed Indoor Units 70 (130%)	14	53.30	3.50	56.61	3.63	59.92	3.76	62.31	3.80	66.54	3.87	69.85	3.95
	20	53.26	3.55	56.57	3.68	59.87	3.81	62.26	3.86	66.49	3.93	69.80	4.01
	25	53.22	3.60	56.52	3.73	59.83	3.87	62.21	3.91	66.44	3.98	69.74	4.06
	30	53.18	3.65	56.48	3.78	59.78	3.92	62.17	3.97	66.39	4.04	69.69	4.12
	35	53.14	3.70	56.44	3.83	59.74	3.97	62.12	4.02	66.34	4.10	69.64	4.18
	40	53.10	3.75	56.39	3.89	59.69	4.03	62.07	4.07	66.29	4.15	69.58	4.23
	45	53.05	3.80	56.35	3.94	59.64	4.08	62.02	4.13	66.23	4.21	69.53	4.29
	50	53.01	3.85	56.31	3.99	59.60	4.14	61.98	4.18	66.18	4.26	69.48	4.35
	55	52.97	3.90	56.26	4.04	59.55	4.19	61.93	4.24	66.13	4.32	69.42	4.40
	60	52.93	3.95	56.22	4.09	59.51	4.24	61.88	4.29	66.08	4.37	69.37	4.46
	65	52.89	4.00	56.18	4.15	59.46	4.30	61.83	4.35	66.03	4.43	69.32	4.52
	70	52.85	4.05	56.13	4.20	59.42	4.35	61.79	4.40	65.98	4.48	69.26	4.58
	75	51.58	4.27	54.85	4.43	58.13	4.59	60.49	4.64	64.68	4.73	67.95	4.82
	80	50.31	4.49	53.57	4.65	56.84	4.82	59.20	4.88	63.37	4.97	66.64	5.07
	85	49.05	4.71	52.31	4.88	55.56	5.06	57.92	5.11	62.08	5.21	65.34	5.32
	90	47.79	4.93	51.04	5.11	54.29	5.29	56.63	5.35	60.79	5.45	64.04	5.56
	95	46.42	5.14	49.65	5.33	52.89	5.53	<b>54.37</b>	<b>5.59</b>	59.35	5.69	62.59	5.81
	100	45.29	5.36	48.52	5.56	51.76	5.76	53.67	5.83	58.22	5.94	61.46	6.06
	105	44.16	5.58	47.39	5.78	50.63	6.00	52.96	6.07	57.09	6.18	60.33	6.30
	110	43.03	5.80	46.26	6.01	49.50	6.23	51.83	6.30	55.96	6.42	59.20	6.55
115	41.90	6.02	45.13	6.24	48.36	6.47	50.70	6.54	54.83	6.66	58.07	6.80	
118	41.22	6.15	44.45	6.37	47.69	6.61	50.02	6.68	54.15	6.81	57.39	6.94	
122	40.99	6.32	44.23	6.55	47.46	6.79	49.80	6.87	53.93	7.00	57.16	7.14	

TC = Total Capacity (kBtu/h).

PI = Power Input (kW).

Nominal capacity as rated: 0 ft. above sea level with Piping Length as Main Pipe (16.4 ft.) + Branch pipe (98.4 ft.) = 115 ft.  
0 ft. level difference between outdoor and indoor units.

Nominal cooling capacity rating obtained with air entering the indoor unit at 80°F dry bulb (DB) and 67°F wet bulb (WB), and outdoor ambient conditions of 95°F dry bulb (DB) and 75°F wet bulb (WB).

The shaded table columns and rows indicate reference data. When operating at this temperature, these values can be different if the system is not running consistently.



Multi F and Multi F MAX Heat Pump System Engineering Manual

Table 135: LMU540HV Cooling Capacity Table — Mixed Indoor Units (continued).

Combination Capacity Index (kBtu/h[%])	Outdoor Air Temp. (°F DB)	Indoor Air Temp. °F DB / °F WB											
		68 / 57		73 / 61		77 / 64		80 / 67		86 / 72		90 / 75	
		TC	PI	TC	PI	TC	PI	TC	PI	TC	PI	TC	PI
Mixed Indoor Units 65 (120%)	14	52.49	3.40	55.76	3.53	59.02	3.66	61.37	3.70	65.54	3.77	68.80	3.84
	20	52.45	3.45	55.71	3.58	58.97	3.71	61.32	3.75	65.49	3.82	68.74	3.90
	25	52.41	3.50	55.67	3.63	58.93	3.76	61.28	3.81	65.44	3.88	68.69	3.96
	30	52.37	3.55	55.63	3.68	58.88	3.82	61.23	3.86	65.39	3.93	68.64	4.01
	35	52.33	3.60	55.58	3.73	58.84	3.87	61.18	3.91	65.34	3.99	68.59	4.07
	40	52.29	3.65	55.54	3.78	58.79	3.92	61.14	3.97	65.29	4.04	68.53	4.12
	45	52.25	3.70	55.50	3.83	58.75	3.97	61.09	4.02	65.24	4.09	68.48	4.18
	50	52.21	3.75	55.46	3.88	58.70	4.03	61.04	4.07	65.19	4.15	68.43	4.23
	55	52.17	3.80	55.41	3.93	58.66	4.08	61.00	4.12	65.14	4.20	68.38	4.29
	60	52.13	3.84	55.37	3.98	58.61	4.13	60.95	4.18	65.09	4.26	68.32	4.34
	65	52.09	3.89	55.33	4.04	58.57	4.18	60.90	4.23	65.04	4.31	68.27	4.40
	70	52.05	3.94	55.29	4.09	58.52	4.24	60.85	4.28	64.99	4.36	68.22	4.45
	75	50.80	4.16	54.03	4.31	57.25	4.46	59.58	4.52	63.70	4.60	66.93	4.69
	80	49.55	4.37	52.77	4.53	55.98	4.69	58.31	4.75	62.42	4.84	65.63	4.93
	85	48.31	4.58	51.52	4.75	54.73	4.92	57.04	4.98	61.14	5.07	64.35	5.17
	90	47.07	4.79	50.27	4.97	53.47	5.15	55.78	5.21	59.87	5.31	63.07	5.41
	95	45.72	5.01	48.90	5.19	52.09	5.38	<b>53.55</b>	<b>5.44</b>	58.46	5.54	61.64	5.65
	100	44.61	5.22	47.79	5.41	50.98	5.61	52.86	5.67	57.35	5.78	60.53	5.89
	105	43.49	5.43	46.68	5.63	49.86	5.84	52.16	5.90	56.23	6.01	59.42	6.13
	110	42.38	5.64	45.56	5.85	48.75	6.06	51.05	6.13	55.12	6.25	58.30	6.37
115	41.27	5.86	44.45	6.07	47.64	6.29	49.94	6.36	54.01	6.48	57.19	6.61	
118	40.60	5.98	43.78	6.20	46.97	6.43	49.27	6.50	53.34	6.63	56.52	6.76	
122	40.37	6.15	43.56	6.38	46.74	6.61	49.05	6.69	53.11	6.81	56.30	6.95	
Mixed Indoor Units 59 (110%)	14	51.53	3.29	54.73	3.41	57.94	3.53	60.25	3.57	64.34	3.64	67.54	3.71
	20	51.49	3.33	54.69	3.45	57.89	3.58	60.20	3.62	64.29	3.69	67.49	3.76
	25	51.46	3.38	54.65	3.50	57.85	3.63	60.15	3.67	64.24	3.74	67.43	3.82
	30	51.42	3.43	54.61	3.55	57.80	3.68	60.11	3.72	64.19	3.79	67.38	3.87
	35	51.38	3.47	54.57	3.60	57.76	3.73	60.06	3.78	64.14	3.85	67.33	3.92
	40	51.34	3.52	54.53	3.65	57.71	3.78	60.02	3.83	64.09	3.90	67.28	3.98
	45	51.30	3.57	54.48	3.70	57.67	3.83	59.97	3.88	64.04	3.95	67.23	4.03
	50	51.26	3.62	54.44	3.75	57.63	3.88	59.93	3.93	63.99	4.00	67.18	4.08
	55	51.22	3.66	54.40	3.80	57.58	3.94	59.88	3.98	63.94	4.06	67.12	4.14
	60	51.18	3.71	54.36	3.85	57.54	3.99	59.83	4.03	63.89	4.11	67.07	4.19
	65	51.14	3.76	54.32	3.89	57.49	4.04	59.79	4.08	63.85	4.16	67.02	4.24
	70	51.10	3.80	54.28	3.94	57.45	4.09	59.74	4.13	63.80	4.21	66.97	4.30
	75	49.87	4.01	53.04	4.16	56.20	4.31	58.49	4.36	62.54	4.44	65.70	4.53
	80	48.64	4.22	51.80	4.37	54.96	4.53	57.24	4.58	61.27	4.67	64.43	4.76
	85	47.42	4.42	50.57	4.58	53.72	4.75	56.00	4.80	60.02	4.89	63.17	4.99
	90	46.20	4.63	49.35	4.79	52.49	4.97	54.76	5.03	58.77	5.12	61.92	5.22
	95	44.88	4.83	48.01	5.01	51.14	5.19	<b>52.57</b>	<b>5.25</b>	57.39	5.35	60.52	5.46
	100	43.79	5.04	46.92	5.22	50.04	5.41	51.89	5.47	56.30	5.58	59.42	5.69
	105	42.70	5.24	45.82	5.43	48.95	5.63	51.21	5.70	55.20	5.80	58.33	5.92
	110	41.60	5.45	44.73	5.65	47.86	5.85	50.11	5.92	54.11	6.03	57.24	6.15
115	40.51	5.65	43.64	5.86	46.76	6.07	49.02	6.14	53.02	6.26	56.14	6.38	
118	39.85	5.78	42.98	5.99	46.11	6.20	48.37	6.28	52.36	6.39	55.49	6.52	
122	39.64	5.94	42.76	6.16	45.89	6.38	48.15	6.45	52.14	6.58	55.27	6.71	

TC = Total Capacity (kBtu/h).

PI = Power Input (kW).

Nominal capacity as rated: 0 ft. above sea level with Piping Length as Main Pipe (16.4 ft.) + Branch pipe (98.4 ft.) = 115 ft.  
0 ft. level difference between outdoor and indoor units.

Nominal cooling capacity rating obtained with air entering the indoor unit at 80°F dry bulb (DB) and 67°F wet bulb (WB), and outdoor ambient conditions of 95°F dry bulb (DB) and 75°F wet bulb (WB).

The shaded table columns and rows indicate reference data. When operating at this temperature, these values can be different if the system is not running consistently.

# PERFORMANCE DATA

MULTI F  
MULTI F MAX

## Cooling Capacity Tables

Table 136: LMU540HV Cooling Capacity Table — Mixed Indoor Units (continued).

Combination Capacity Index (kBtu/h[%])	Outdoor Air Temp. (°F DB)	Indoor Air Temp. °F DB / °F WB											
		68 / 57		73 / 61		77 / 64		80 / 67		86 / 72		90 / 75	
		TC	PI	TC	PI	TC	PI	TC	PI	TC	PI	TC	PI
Mixed Indoor Units 54 (100%)	14	50.73	3.19	53.88	3.31	57.03	3.43	59.31	3.47	63.33	3.53	66.48	3.60
	20	50.69	3.24	53.84	3.36	56.99	3.48	59.26	3.52	63.28	3.58	66.43	3.66
	25	50.65	3.28	53.80	3.40	56.94	3.53	59.22	3.57	63.24	3.63	66.38	3.71
	30	50.61	3.33	53.76	3.45	56.90	3.58	59.17	3.62	63.19	3.69	66.33	3.76
	35	50.58	3.38	53.72	3.50	56.86	3.63	59.13	3.67	63.14	3.74	66.28	3.81
	40	50.54	3.42	53.68	3.55	56.81	3.68	59.08	3.72	63.09	3.79	66.23	3.86
	45	50.50	3.47	53.63	3.59	56.77	3.72	59.04	3.77	63.04	3.84	66.18	3.92
	50	50.46	3.51	53.59	3.64	56.73	3.77	58.99	3.82	62.99	3.89	66.13	3.97
	55	50.42	3.56	53.55	3.69	56.68	3.82	58.95	3.87	62.95	3.94	66.08	4.02
	60	50.38	3.60	53.51	3.74	56.64	3.87	58.90	3.92	62.90	3.99	66.03	4.07
	65	50.34	3.65	53.47	3.78	56.60	3.92	58.85	3.97	62.85	4.04	65.98	4.12
	70	50.30	3.70	53.43	3.83	56.55	3.97	58.81	4.02	62.80	4.09	65.93	4.17
	75	49.09	3.90	52.21	4.04	55.33	4.19	57.58	4.23	61.56	4.31	64.68	4.40
	80	47.88	4.09	50.99	4.24	54.10	4.40	56.35	4.45	60.32	4.53	63.43	4.62
	85	46.68	4.29	49.78	4.45	52.89	4.61	55.13	4.67	59.09	4.75	62.19	4.85
	90	45.48	4.49	48.58	4.66	51.67	4.83	53.90	4.88	57.86	4.97	60.95	5.07
	95	44.18	4.69	47.26	4.86	50.34	5.04	<b>51.75</b>	<b>5.10</b>	56.49	5.20	59.57	5.30
	100	43.11	4.89	46.18	5.07	49.26	5.26	51.08	5.32	55.42	5.42	58.50	5.53
	105	42.03	5.09	45.11	5.28	48.19	5.47	50.41	5.53	54.34	5.64	57.42	5.75
	110	40.95	5.29	44.03	5.48	47.11	5.68	49.33	5.75	53.27	5.86	56.34	5.98
115	39.88	5.49	42.96	5.69	46.03	5.90	48.26	5.97	52.19	6.08	55.27	6.20	
118	39.23	5.61	42.31	5.82	45.39	6.03	47.61	6.10	51.54	6.21	54.62	6.34	
122	39.02	5.77	42.10	5.98	45.17	6.20	47.40	6.27	51.33	6.39	54.41	6.52	
Mixed Indoor Units 49 (90%)	14	46.03	2.82	48.89	2.93	51.75	3.03	53.82	3.07	57.47	3.12	60.33	3.19
	20	46.00	2.86	48.86	2.97	51.71	3.08	53.78	3.11	57.43	3.17	60.28	3.23
	25	45.96	2.90	48.82	3.01	51.67	3.12	53.74	3.16	57.38	3.21	60.24	3.28
	30	45.93	2.94	48.78	3.05	51.63	3.16	53.69	3.20	57.34	3.26	60.19	3.32
	35	45.89	2.98	48.74	3.09	51.59	3.21	53.65	3.24	57.30	3.30	60.15	3.37
	40	45.86	3.03	48.71	3.14	51.56	3.25	53.61	3.29	57.25	3.35	60.10	3.42
	45	45.82	3.07	48.67	3.18	51.52	3.29	53.57	3.33	57.21	3.39	60.05	3.46
	50	45.79	3.11	48.63	3.22	51.48	3.34	53.53	3.38	57.16	3.44	60.01	3.51
	55	45.75	3.15	48.60	3.26	51.44	3.38	53.49	3.42	57.12	3.48	59.96	3.55
	60	45.72	3.19	48.56	3.30	51.40	3.42	53.45	3.46	57.08	3.53	59.92	3.60
	65	45.68	3.23	48.52	3.35	51.36	3.47	53.41	3.51	57.03	3.57	59.87	3.65
	70	45.65	3.27	48.48	3.39	51.32	3.51	53.37	3.55	56.99	3.62	59.82	3.69
	75	44.55	3.44	47.38	3.57	50.21	3.70	52.25	3.74	55.86	3.81	58.69	3.89
	80	43.45	3.62	46.27	3.75	49.09	3.89	51.13	3.94	54.74	4.01	57.56	4.09
	85	42.36	3.80	45.18	3.94	47.99	4.08	50.02	4.13	53.62	4.20	56.43	4.29
	90	41.27	3.97	44.08	4.12	46.89	4.27	48.92	4.32	52.50	4.40	55.31	4.49
	95	40.09	4.15	42.89	4.30	45.68	4.46	<b>46.96</b>	<b>4.51</b>	51.26	4.59	54.06	4.69
	100	39.12	4.33	41.91	4.48	44.70	4.65	46.35	4.70	50.29	4.79	53.08	4.89
	105	38.14	4.50	40.93	4.67	43.73	4.84	45.74	4.89	49.31	4.98	52.11	5.09
	110	37.16	4.68	39.96	4.85	42.75	5.03	44.77	5.08	48.34	5.18	51.13	5.28
115	36.19	4.86	38.98	5.03	41.77	5.22	43.79	5.28	47.36	5.38	50.15	5.48	
118	35.60	4.96	38.39	5.14	41.19	5.33	43.20	5.39	46.77	5.49	49.57	5.60	
122	35.41	5.10	38.20	5.29	40.99	5.48	43.01	5.54	46.58	5.65	49.37	5.76	

TC = Total Capacity (kBtu/h).

PI = Power Input (kW).

Nominal capacity as rated: 0 ft. above sea level with Piping Length as Main Pipe (16.4 ft.) + Branch pipe (98.4 ft.) = 115 ft.  
0 ft. level difference between outdoor and indoor units.

Nominal cooling capacity rating obtained with air entering the indoor unit at 80°F dry bulb (DB) and 67°F wet bulb (WB), and outdoor ambient conditions of 95°F dry bulb (DB) and 75°F wet bulb (WB).

The shaded table columns and rows indicate reference data. When operating at this temperature, these values can be different if the system is not running consistently.



Multi F and Multi F MAX Heat Pump System Engineering Manual

Table 137: LMU540HV Cooling Capacity Table — Mixed Indoor Units (continued).

Combination Capacity Index (kBtu/h[%])	Outdoor Air Temp. (°F DB)	Indoor Air Temp. °F DB / °F WB											
		68 / 57		73 / 61		77 / 64		80 / 67		86 / 72		90 / 75	
		TC	PI	TC	PI	TC	PI	TC	PI	TC	PI	TC	PI
Mixed Indoor Units 43 (80%)	14	40.40	2.38	42.91	2.46	45.42	2.55	47.23	2.58	50.43	2.63	52.94	2.69
	20	40.37	2.41	42.87	2.50	45.38	2.59	47.19	2.62	50.40	2.67	52.90	2.72
	25	40.34	2.45	42.84	2.54	45.35	2.63	47.16	2.66	50.36	2.71	52.86	2.76
	30	40.31	2.48	42.81	2.57	45.31	2.66	47.12	2.70	50.32	2.75	52.82	2.80
	35	40.27	2.51	42.78	2.61	45.28	2.70	47.08	2.73	50.28	2.78	52.78	2.84
	40	40.24	2.55	42.74	2.64	45.24	2.74	47.05	2.77	50.24	2.82	52.74	2.88
	45	40.21	2.58	42.71	2.68	45.21	2.78	47.01	2.81	50.20	2.86	52.70	2.92
	50	40.18	2.62	42.68	2.71	45.17	2.81	46.98	2.84	50.16	2.90	52.66	2.96
	55	40.15	2.65	42.65	2.75	45.14	2.85	46.94	2.88	50.13	2.94	52.62	2.99
	60	40.12	2.69	42.61	2.78	45.10	2.89	46.90	2.92	50.09	2.97	52.58	3.03
	65	40.09	2.72	42.58	2.82	45.07	2.92	46.87	2.96	50.05	3.01	52.54	3.07
	70	40.06	2.75	42.55	2.85	45.03	2.96	46.83	2.99	50.01	3.05	52.50	3.11
	75	39.10	2.90	41.58	3.01	44.06	3.12	45.85	3.15	49.02	3.21	51.50	3.28
	80	38.13	3.05	40.61	3.16	43.08	3.28	44.87	3.32	48.03	3.38	50.51	3.45
	85	37.18	3.20	39.65	3.32	42.11	3.44	43.90	3.48	47.05	3.54	49.52	3.61
	90	36.22	3.35	38.68	3.47	41.15	3.60	42.93	3.64	46.07	3.71	48.54	3.78
	95	35.18	3.50	37.63	3.62	40.09	3.76	<b>41.21</b>	<b>3.80</b>	44.99	3.87	47.44	3.95
	100	34.33	3.65	36.78	3.78	39.23	3.92	40.68	3.96	44.13	4.04	46.58	4.12
	105	33.47	3.79	35.92	3.93	38.37	4.08	40.14	4.12	43.27	4.20	45.73	4.28
	110	32.61	3.94	35.06	4.09	37.52	4.24	39.29	4.28	42.42	4.36	44.87	4.45
115	31.76	4.09	34.21	4.24	36.66	4.40	38.43	4.45	41.56	4.53	44.01	4.62	
118	31.24	4.18	33.69	4.33	36.14	4.49	37.91	4.54	41.05	4.63	43.50	4.72	
122	31.07	4.30	33.52	4.46	35.97	4.62	37.74	4.67	40.88	4.76	43.33	4.86	
Mixed Indoor Units 38 (70%)	14	35.70	2.01	37.92	2.08	40.14	2.16	41.74	2.18	44.57	2.22	46.79	2.27
	20	35.68	2.04	37.89	2.11	40.11	2.19	41.71	2.21	44.54	2.26	46.75	2.30
	25	35.65	2.07	37.86	2.14	40.08	2.22	41.67	2.25	44.50	2.29	46.72	2.33
	30	35.62	2.10	37.83	2.17	40.05	2.25	41.64	2.28	44.47	2.32	46.68	2.37
	35	35.59	2.12	37.80	2.20	40.01	2.28	41.61	2.31	44.44	2.35	46.65	2.40
	40	35.57	2.15	37.78	2.23	39.98	2.31	41.58	2.34	44.40	2.38	46.61	2.43
	45	35.54	2.18	37.75	2.26	39.95	2.34	41.55	2.37	44.37	2.42	46.57	2.46
	50	35.51	2.21	37.72	2.29	39.92	2.38	41.52	2.40	44.33	2.45	46.54	2.50
	55	35.48	2.24	37.69	2.32	39.89	2.41	41.48	2.43	44.30	2.48	46.50	2.53
	60	35.46	2.27	37.66	2.35	39.86	2.44	41.45	2.47	44.27	2.51	46.47	2.56
	65	35.43	2.30	37.63	2.38	39.83	2.47	41.42	2.50	44.23	2.54	46.43	2.59
	70	35.40	2.33	37.60	2.41	39.80	2.50	41.39	2.53	44.20	2.58	46.40	2.63
	75	34.55	2.45	36.74	2.54	38.94	2.63	40.52	2.66	43.32	2.71	45.52	2.77
	80	33.70	2.58	35.89	2.67	38.07	2.77	39.65	2.80	42.45	2.85	44.64	2.91
	85	32.85	2.70	35.04	2.80	37.22	2.90	38.80	2.94	41.58	2.99	43.77	3.05
	90	32.01	2.83	34.19	2.93	36.36	3.04	37.94	3.07	40.72	3.13	42.90	3.19
	95	31.09	2.95	33.26	3.06	35.43	3.17	<b>36.42</b>	<b>3.21</b>	39.76	3.27	41.92	3.34
	100	30.34	3.08	32.50	3.19	34.67	3.31	35.95	3.35	39.00	3.41	41.17	3.48
	105	29.58	3.20	31.75	3.32	33.91	3.44	35.48	3.48	38.24	3.55	40.41	3.62
	110	28.82	3.33	30.99	3.45	33.15	3.58	34.72	3.62	37.49	3.69	39.65	3.76
115	28.07	3.46	30.23	3.58	32.40	3.71	33.96	3.76	36.73	3.83	38.90	3.90	
118	27.61	3.53	29.78	3.66	31.94	3.79	33.51	3.84	36.28	3.91	38.44	3.99	
122	27.46	3.63	29.63	3.76	31.79	3.90	33.36	3.95	36.12	4.02	38.29	4.10	

TC = Total Capacity (kBtu/h).

PI = Power Input (kW).

Nominal capacity as rated: 0 ft. above sea level with Piping Length as Main Pipe (16.4 ft.) + Branch pipe (98.4 ft.) = 115 ft.  
0 ft. level difference between outdoor and indoor units.

Nominal cooling capacity rating obtained with air entering the indoor unit at 80°F dry bulb (DB) and 67°F wet bulb (WB), and outdoor ambient conditions of 95°F dry bulb (DB) and 75°F wet bulb (WB).

The shaded table columns and rows indicate reference data. When operating at this temperature, these values can be different if the system is not running consistently.

# PERFORMANCE DATA

## Cooling Capacity Tables

MULTI F  
MULTI F MAX

Table 138: LMU540HV Cooling Capacity Table — Mixed Indoor Units (continued).

Combination Capacity Index (kBtu/h[%])	Outdoor Air Temp. (°F DB)	Indoor Air Temp. °F DB / °F WB											
		68 / 57		73 / 61		77 / 64		80 / 67		86 / 72		90 / 75	
		TC	PI	TC	PI	TC	PI	TC	PI	TC	PI	TC	PI
Mixed Indoor Units 32 (60%)	14	30.07	1.56	31.93	1.62	33.80	1.68	35.15	1.70	37.53	1.73	39.40	1.77
	20	30.04	1.59	31.91	1.64	33.77	1.70	35.12	1.72	37.51	1.76	39.37	1.79
	25	30.02	1.61	31.88	1.67	33.75	1.73	35.10	1.75	37.48	1.78	39.34	1.82
	30	30.00	1.63	31.86	1.69	33.72	1.75	35.07	1.77	37.45	1.81	39.31	1.84
	35	29.97	1.65	31.84	1.71	33.70	1.78	35.04	1.80	37.42	1.83	39.28	1.87
	40	29.95	1.68	31.81	1.74	33.67	1.80	35.01	1.82	37.39	1.86	39.25	1.89
	45	29.93	1.70	31.79	1.76	33.65	1.83	34.99	1.85	37.36	1.88	39.22	1.92
	50	29.91	1.72	31.76	1.78	33.62	1.85	34.96	1.87	37.33	1.91	39.19	1.94
	55	29.88	1.74	31.74	1.81	33.59	1.87	34.93	1.90	37.31	1.93	39.16	1.97
	60	29.86	1.77	31.71	1.83	33.57	1.90	34.91	1.92	37.28	1.96	39.13	2.00
	65	29.84	1.79	31.69	1.85	33.54	1.92	34.88	1.94	37.25	1.98	39.10	2.02
	70	29.81	1.81	31.67	1.88	33.52	1.95	34.85	1.97	37.22	2.01	39.07	2.05
	75	29.10	1.91	30.94	1.98	32.79	2.05	34.12	2.08	36.48	2.11	38.33	2.16
	80	28.38	2.01	30.22	2.08	32.06	2.16	33.39	2.18	35.75	2.22	37.59	2.27
	85	27.67	2.10	29.51	2.18	31.34	2.26	32.67	2.29	35.02	2.33	36.86	2.38
	90	26.96	2.20	28.79	2.28	30.62	2.37	31.95	2.39	34.29	2.44	36.12	2.49
	95	26.18	2.30	28.01	2.38	29.83	2.47	<b>30.67</b>	<b>2.50</b>	33.48	2.55	35.31	2.60
	100	25.55	2.40	27.37	2.49	29.20	2.58	30.27	2.61	32.84	2.66	34.67	2.71
105	24.91	2.50	26.73	2.59	28.56	2.68	29.88	2.71	32.21	2.76	34.03	2.82	
110	24.27	2.59	26.10	2.69	27.92	2.79	29.24	2.82	31.57	2.87	33.39	2.93	
115	23.63	2.69	25.46	2.79	27.28	2.89	28.60	2.92	30.93	2.98	32.76	3.04	
118	23.25	2.75	25.08	2.85	26.90	2.95	28.22	2.99	30.55	3.04	32.37	3.11	
122	23.12	2.83	24.95	2.93	26.77	3.04	28.09	3.07	30.42	3.13	32.24	3.19	
Mixed Indoor Units 27 (50%)	14	25.37	1.20	26.95	1.24	28.52	1.28	29.66	1.30	31.67	1.32	33.25	1.35
	20	25.35	1.21	26.93	1.26	28.50	1.30	29.64	1.32	31.65	1.34	33.22	1.37
	25	25.33	1.23	26.90	1.27	28.48	1.32	29.61	1.34	31.62	1.36	33.20	1.39
	30	25.31	1.25	26.88	1.29	28.46	1.34	29.59	1.35	31.60	1.38	33.17	1.41
	35	25.29	1.26	26.86	1.31	28.43	1.36	29.57	1.37	31.58	1.40	33.15	1.43
	40	25.27	1.28	26.84	1.33	28.41	1.38	29.55	1.39	31.55	1.42	33.12	1.45
	45	25.25	1.30	26.82	1.35	28.39	1.39	29.52	1.41	31.53	1.44	33.10	1.47
	50	25.23	1.32	26.80	1.36	28.37	1.41	29.50	1.43	31.50	1.46	33.07	1.49
	55	25.22	1.33	26.78	1.38	28.35	1.43	29.48	1.45	31.48	1.48	33.05	1.51
	60	25.20	1.35	26.76	1.40	28.33	1.45	29.46	1.47	31.46	1.49	33.02	1.52
	65	25.18	1.37	26.74	1.42	28.30	1.47	29.43	1.49	31.43	1.51	32.99	1.54
	70	25.16	1.38	26.72	1.43	28.28	1.49	29.41	1.50	31.41	1.53	32.97	1.56
	75	24.55	1.46	26.11	1.51	27.67	1.57	28.79	1.59	30.79	1.62	32.34	1.65
	80	23.95	1.53	25.50	1.59	27.06	1.65	28.18	1.67	30.17	1.70	31.72	1.73
	85	23.35	1.61	24.90	1.67	26.45	1.73	27.57	1.75	29.55	1.78	31.10	1.82
	90	22.75	1.68	24.29	1.74	25.84	1.81	26.96	1.83	28.93	1.86	30.48	1.90
	95	22.10	1.76	23.63	1.82	25.17	1.89	<b>25.88</b>	<b>1.91</b>	28.25	1.95	29.79	1.98
	100	21.56	1.83	23.10	1.90	24.64	1.97	25.54	1.99	27.71	2.03	29.25	2.07
105	21.02	1.91	22.56	1.98	24.10	2.05	25.21	2.07	27.18	2.11	28.72	2.15	
110	20.48	1.98	22.02	2.05	23.56	2.13	24.67	2.15	26.64	2.19	28.18	2.24	
115	19.94	2.06	21.48	2.13	23.02	2.21	24.13	2.23	26.10	2.28	27.64	2.32	
118	19.62	2.10	21.16	2.18	22.70	2.26	23.81	2.28	25.78	2.33	27.32	2.37	
122	19.51	2.16	21.05	2.24	22.59	2.32	23.70	2.35	25.67	2.39	27.21	2.44	

TC = Total Capacity (kBtu/h).

PI = Power Input (kW).

Nominal capacity as rated: 0 ft. above sea level with Piping Length as Main Pipe (16.4 ft.) + Branch pipe (98.4 ft.) = 115 ft.  
0 ft. level difference between outdoor and indoor units.

Nominal cooling capacity rating obtained with air entering the indoor unit at 80°F dry bulb (DB) and 67°F wet bulb (WB), and outdoor ambient conditions of 95°F dry bulb (DB) and 75°F wet bulb (WB).

The shaded table columns and rows indicate reference data. When operating at this temperature, these values can be different if the system is not running consistently.



Table 139: LMU540HV Cooling Capacity Table — Mixed Indoor Units (continued).

Combination Capacity Index (kBtu/h[%])	Outdoor Air Temp. (°F DB)	Indoor Air Temp. °F DB / °F WB											
		68 / 57		73 / 61		77 / 64		80 / 67		86 / 72		90 / 75	
		TC	PI	TC	PI	TC	PI	TC	PI	TC	PI	TC	PI
Mixed Indoor Units 24 (40%)	14	22.55	0.97	23.95	1.01	25.35	1.04	26.36	1.05	28.15	1.07	29.55	1.10
	20	22.53	0.98	23.93	1.02	25.33	1.06	26.34	1.07	28.13	1.09	29.53	1.11
	25	22.51	1.00	23.91	1.03	25.31	1.07	26.32	1.08	28.10	1.10	29.50	1.13
	30	22.50	1.01	23.89	1.05	25.29	1.09	26.30	1.10	28.08	1.12	29.48	1.14
	35	22.48	1.03	23.87	1.06	25.27	1.10	26.28	1.11	28.06	1.14	29.46	1.16
	40	22.46	1.04	23.86	1.08	25.25	1.12	26.26	1.13	28.04	1.15	29.44	1.17
	45	22.44	1.05	23.84	1.09	25.23	1.13	26.24	1.14	28.02	1.17	29.41	1.19
	50	22.43	1.07	23.82	1.11	25.21	1.15	26.22	1.16	28.00	1.18	29.39	1.21
	55	22.41	1.08	23.80	1.12	25.19	1.16	26.20	1.18	27.98	1.20	29.37	1.22
	60	22.39	1.10	23.78	1.14	25.17	1.18	26.18	1.19	27.95	1.21	29.35	1.24
	65	22.37	1.11	23.76	1.15	25.15	1.19	26.16	1.21	27.93	1.23	29.32	1.25
	70	22.36	1.12	23.75	1.16	25.13	1.21	26.14	1.22	27.91	1.24	29.30	1.27
	75	21.82	1.18	23.20	1.23	24.59	1.27	25.59	1.29	27.36	1.31	28.75	1.34
	80	21.28	1.24	22.66	1.29	24.04	1.34	25.04	1.35	26.81	1.38	28.19	1.41
	85	20.75	1.31	22.13	1.35	23.50	1.40	24.50	1.42	26.26	1.44	27.64	1.47
	90	20.22	1.37	21.59	1.42	22.96	1.47	23.96	1.48	25.71	1.51	27.09	1.54
	95	19.64	1.43	21.00	1.48	22.37	1.53	<b>23.00</b>	<b>1.55</b>	25.11	1.58	26.48	1.61
	100	19.16	1.49	20.53	1.54	21.89	1.60	22.70	1.62	24.63	1.65	26.00	1.68
	105	18.68	1.55	20.05	1.60	21.42	1.66	22.40	1.68	24.15	1.71	25.52	1.75
	110	18.20	1.61	19.57	1.67	20.94	1.73	21.93	1.75	23.67	1.78	25.04	1.82
115	17.72	1.67	19.09	1.73	20.46	1.79	21.45	1.81	23.20	1.85	24.56	1.88	
118	17.44	1.71	18.80	1.77	20.17	1.83	21.16	1.85	22.91	1.89	24.28	1.93	
122	17.34	1.75	18.71	1.82	20.08	1.88	21.07	1.91	22.81	1.94	24.18	1.98	

TC = Total Capacity (kBtu/h).

PI = Power Input (kW).

Nominal capacity as rated: 0 ft. above sea level with Piping Length as Main Pipe (16.4 ft.) + Branch pipe (98.4 ft.) = 115 ft.  
0 ft. level difference between outdoor and indoor units.

Nominal cooling capacity rating obtained with air entering the indoor unit at 80°F dry bulb (DB) and 67°F wet bulb (WB), and outdoor ambient conditions of 95°F dry bulb (DB) and 75°F wet bulb (WB).

The shaded table columns and rows indicate reference data. When operating at this temperature, these values can be different if the system is not running consistently.

# PERFORMANCE DATA

## Heating Capacity Tables

MULTI F  
MULTI F MAX

Table 140: LMU540HV Heating Capacity Table — Non-Ducted Indoor Units.

Combination Capacity Index (kBtu/h[%])	Outdoor Air Temp.		Indoor Air Temp. °F DB											
			61		64		68		70		72		75	
	°F DB	°F WB	TC	PI	TC	PI	TC	PI	TC	PI	TC	PI	TC	PI
Non-Ducted Indoor Units 73 (135%)	0	-0.4	28.30	3.71	26.61	3.85	26.64	3.91	26.03	3.94	25.54	3.97	24.45	4.11
	5	4.5	34.08	3.88	32.48	4.02	32.01	4.10	31.33	4.14	30.79	4.18	29.55	4.32
	10	9	37.95	4.03	36.42	4.17	35.61	4.27	34.89	4.33	34.31	4.38	32.96	4.51
	17	15	42.21	4.23	40.74	4.37	39.57	4.50	<b>38.80</b>	<b>4.58</b>	38.18	4.64	36.71	4.77
	20	19	44.80	4.37	43.37	4.50	41.97	4.66	41.17	4.74	40.52	4.81	38.98	4.94
	25	23	49.10	4.61	47.64	4.74	45.98	4.92	45.11	5.02	44.42	5.10	42.75	5.23
	30	28	53.41	4.86	51.76	5.02	49.98	5.18	49.06	5.29	48.33	5.38	46.55	5.52
	35	32	57.72	5.12	55.88	5.30	53.98	5.44	53.01	5.57	52.23	5.67	50.35	5.81
	40	36	60.66	5.27	58.96	5.45	57.08	5.61	56.09	5.73	55.30	5.82	53.30	5.97
	45	41	64.34	5.46	62.80	5.64	60.95	5.82	59.94	5.92	59.13	6.01	56.98	6.18
	47	43	65.81	5.53	64.34	5.72	62.50	5.90	<b>61.48</b>	<b>6.00</b>	60.66	6.08	58.46	6.26
	50	46	66.00	5.50	64.67	5.66	63.07	5.83	62.16	5.91	61.43	5.98	59.35	6.15
	55	51	66.33	5.44	65.23	5.57	64.02	5.71	63.29	5.77	62.70	5.82	60.84	5.95
	60	56	66.65	5.38	65.78	5.49	64.97	5.59	64.42	5.63	63.97	5.66	62.33	5.75
	63	59	66.84	5.35	66.11	5.43	65.54	5.51	65.09	5.54	64.73	5.56	63.23	5.63
	68	64	67.04	5.31	66.45	5.38	66.12	5.44	65.78	5.46	65.51	5.47	64.14	5.51
	Non-Ducted Indoor Units 70 (130%)	0	-0.4	28.04	3.66	26.37	3.80	26.40	3.85	25.79	3.88	25.31	3.91	24.24
5		4.5	33.77	3.82	32.19	3.96	31.73	4.04	31.05	4.08	30.51	4.12	29.28	4.26
10		9	37.61	3.97	36.09	4.11	35.29	4.21	34.57	4.27	34.00	4.31	32.66	4.45
17		15	41.84	4.17	40.38	4.30	39.22	4.44	<b>38.45</b>	<b>4.51</b>	37.83	4.57	36.38	4.70
20		19	44.39	4.30	42.98	4.43	41.60	4.59	40.80	4.67	40.16	4.74	38.63	4.87
25		23	48.66	4.54	47.21	4.67	45.57	4.84	44.71	4.94	44.02	5.02	42.36	5.15
30		28	52.93	4.79	51.29	4.95	49.53	5.10	48.62	5.21	47.90	5.30	46.14	5.44
35		32	57.21	5.04	55.38	5.22	53.50	5.36	52.54	5.48	51.77	5.58	49.90	5.72
40		36	60.12	5.19	58.43	5.37	56.57	5.52	55.59	5.64	54.80	5.73	52.82	5.88
45		41	63.76	5.38	62.24	5.56	60.41	5.73	59.40	5.83	58.60	5.92	56.47	6.09
47		43	65.22	5.45	63.76	5.63	61.94	5.81	<b>60.93</b>	<b>5.91</b>	60.12	5.99	57.93	6.17
50		46	65.41	5.42	64.09	5.58	62.51	5.74	61.60	5.83	60.88	5.89	58.82	6.05
55		51	65.73	5.36	64.64	5.49	63.45	5.62	62.72	5.68	62.14	5.74	60.30	5.86
60		56	66.05	5.30	65.19	5.40	64.39	5.50	63.84	5.54	63.40	5.58	61.78	5.66
63		59	66.24	5.27	65.52	5.35	64.96	5.43	64.51	5.46	64.15	5.48	62.66	5.55
68		64	66.44	5.23	65.85	5.30	65.52	5.36	65.19	5.38	64.92	5.39	63.56	5.43
Non-Ducted Indoor Units 65 (120%)		0	-0.4	27.62	3.56	25.98	3.69	26.00	3.75	25.41	3.78	24.93	3.80	23.87
	5	4.5	33.27	3.72	31.71	3.85	31.25	3.93	30.59	3.97	30.06	4.01	28.84	4.14
	10	9	37.05	3.86	35.55	3.99	34.77	4.09	34.06	4.15	33.49	4.19	32.17	4.33
	17	15	41.21	4.06	39.78	4.19	38.63	4.32	<b>37.87</b>	<b>4.39</b>	37.27	4.44	35.84	4.57
	20	19	43.73	4.19	42.34	4.31	40.97	4.46	40.19	4.55	39.56	4.61	38.05	4.74
	25	23	47.93	4.41	46.51	4.54	44.89	4.71	44.04	4.81	43.36	4.89	41.73	5.01
	30	28	52.14	4.66	50.53	4.81	48.79	4.96	47.90	5.07	47.18	5.16	45.45	5.29
	35	32	56.35	4.91	54.56	5.08	52.70	5.21	51.75	5.34	50.99	5.43	49.15	5.56
	40	36	59.22	5.05	57.56	5.23	55.72	5.37	54.76	5.49	53.99	5.58	52.03	5.72
	45	41	62.81	5.23	61.31	5.41	59.50	5.57	58.52	5.67	57.73	5.76	55.63	5.92
	47	43	64.25	5.30	62.81	5.48	61.02	5.65	<b>60.02</b>	<b>5.75</b>	59.22	5.83	57.07	6.00
	50	46	64.44	5.27	63.14	5.43	61.57	5.58	60.68	5.67	59.97	5.74	57.94	5.89
	55	51	64.75	5.21	63.68	5.34	62.50	5.47	61.78	5.53	61.21	5.58	59.40	5.70
	60	56	65.07	5.16	64.22	5.26	63.43	5.35	62.89	5.39	62.45	5.43	60.85	5.51
	63	59	65.25	5.12	64.54	5.21	63.98	5.28	63.55	5.31	63.20	5.33	61.73	5.40
	68	64	65.44	5.09	64.87	5.16	64.55	5.22	64.22	5.23	63.95	5.24	62.61	5.28

TC = Total Capacity (kBtu/h).

PI = Power Input (kW).

Nominal Capacity as rated: 0 ft. above sea level with Piping Length as Main Pipe (16.4 ft.) + Branch pipe (98.4 ft.) = 115 ft.

0 ft. level difference between outdoor and indoor units.

Nominal heating capacity rating obtained with air entering the indoor unit at 70°F dry bulb (DB) and 60°F wet bulb (WB), and outdoor ambient conditions of 47°F dry bulb (DB) and 43°F wet bulb (WB).



Multi F and Multi F MAX Heat Pump System Engineering Manual

Table 141: LMU540HV Heating Capacity Table — Non-Ducted Indoor Units (continued).

Combination Capacity Index (kBtu/h[%])	Outdoor Air Temp.		Indoor Air Temp. °F DB											
			61		64		68		70		72		75	
	°F DB	°F WB	TC	PI	TC	PI	TC	PI	TC	PI	TC	PI	TC	PI
Non-Ducted Indoor Units 59 (110%)	0	-0.4	27.12	3.44	25.50	3.57	25.53	3.62	24.94	3.65	24.47	3.68	23.44	3.81
	5	4.5	32.66	3.59	31.13	3.72	30.68	3.80	30.03	3.84	29.51	3.87	28.32	4.00
	10	9	36.37	3.73	34.90	3.86	34.13	3.96	33.43	4.01	32.88	4.06	31.58	4.18
	17	15	40.46	3.92	39.05	4.05	37.92	4.17	<b>37.18</b>	<b>4.24</b>	36.59	4.30	35.18	4.42
	20	19	42.93	4.05	41.56	4.17	40.22	4.32	39.45	4.40	38.83	4.46	37.36	4.58
	25	23	47.05	4.27	45.66	4.39	44.07	4.56	43.24	4.65	42.57	4.72	40.97	4.85
	30	28	51.19	4.51	49.60	4.66	47.90	4.80	47.02	4.90	46.32	4.99	44.61	5.11
	35	32	55.32	4.75	53.56	4.92	51.73	5.04	50.80	5.16	50.06	5.25	48.25	5.38
	40	36	58.14	4.88	56.50	5.05	54.70	5.20	53.75	5.31	53.00	5.39	51.08	5.54
	45	41	61.66	5.06	60.19	5.23	58.41	5.39	57.44	5.49	56.67	5.57	54.61	5.73
	47	43	63.07	5.13	61.66	5.30	59.90	5.47	<b>58.92</b>	<b>5.56</b>	58.14	5.64	56.02	5.80
	50	46	63.26	5.09	61.98	5.25	60.45	5.40	59.57	5.48	58.87	5.55	56.88	5.69
	55	51	63.56	5.04	62.51	5.17	61.36	5.29	60.65	5.35	60.09	5.40	58.31	5.51
	60	56	63.87	4.99	63.04	5.08	62.27	5.18	61.73	5.22	61.31	5.25	59.74	5.33
	63	59	64.06	4.95	63.36	5.03	62.81	5.11	62.38	5.14	62.04	5.16	60.60	5.22
	68	64	64.24	4.92	63.68	4.99	63.36	5.04	63.04	5.06	62.78	5.07	61.47	5.11
	Non-Ducted Indoor Units 54 (100%)	0	-0.4	26.69	3.34	25.10	3.47	25.13	3.52	24.55	3.55	24.09	3.57	23.07
5		4.5	32.15	3.49	30.64	3.62	30.20	3.69	29.56	3.73	29.05	3.76	27.87	3.89
10		9	35.80	3.63	34.36	3.75	33.60	3.84	32.91	3.90	32.36	3.94	31.09	4.06
17		15	39.82	3.81	38.44	3.93	37.33	4.05	<b>36.60</b>	<b>4.12</b>	36.01	4.17	34.63	4.30
20		19	42.26	3.93	40.91	4.05	39.60	4.19	38.83	4.27	38.23	4.33	36.77	4.45
25		23	46.32	4.15	44.94	4.27	43.38	4.43	42.56	4.52	41.90	4.59	40.33	4.71
30		28	50.39	4.38	48.83	4.52	47.15	4.66	46.28	4.76	45.59	4.85	43.92	4.97
35		32	54.45	4.61	52.72	4.77	50.93	4.90	50.01	5.01	49.28	5.10	47.50	5.23
40		36	57.23	4.74	55.62	4.91	53.85	5.05	52.92	5.15	52.17	5.24	50.28	5.38
45		41	60.70	4.91	59.25	5.08	57.50	5.23	56.55	5.33	55.78	5.41	53.76	5.56
47		43	62.09	4.98	60.70	5.14	58.96	5.31	<b>58.00</b>	<b>5.40</b>	57.23	5.47	55.15	5.64
50		46	62.27	4.95	61.01	5.10	59.50	5.24	58.64	5.32	57.95	5.39	55.99	5.53
55		51	62.57	4.90	61.53	5.02	60.40	5.14	59.70	5.19	59.15	5.24	57.40	5.35
60		56	62.88	4.84	62.06	4.94	61.29	5.03	60.77	5.07	60.35	5.10	58.81	5.17
63		59	63.06	4.81	62.37	4.89	61.83	4.96	61.41	4.99	61.07	5.01	59.65	5.07
68		64	63.24	4.78	62.69	4.84	62.37	4.90	62.05	4.91	61.80	4.92	60.51	4.96
Non-Ducted Indoor Units 49 (90%)		0	-0.4	24.22	3.01	22.78	3.12	22.80	3.17	22.28	3.19	21.86	3.21	20.93
	5	4.5	29.17	3.14	27.81	3.25	27.40	3.32	26.82	3.36	26.36	3.39	25.29	3.50
	10	9	32.49	3.26	31.17	3.38	30.49	3.46	29.87	3.51	29.37	3.55	28.21	3.66
	17	15	36.14	3.43	34.88	3.54	33.88	3.65	<b>33.21</b>	<b>3.71</b>	32.68	3.76	31.42	3.87
	20	19	38.35	3.54	37.12	3.65	35.93	3.77	35.24	3.84	34.69	3.90	33.37	4.01
	25	23	42.03	3.73	40.78	3.84	39.36	3.98	38.62	4.06	38.02	4.13	36.59	4.24
	30	28	45.72	3.94	44.31	4.07	42.78	4.19	42.00	4.29	41.37	4.36	39.85	4.47
	35	32	49.41	4.15	47.84	4.30	46.21	4.41	45.38	4.51	44.72	4.59	43.10	4.70
	40	36	51.93	4.27	50.47	4.42	48.86	4.54	48.02	4.64	47.34	4.71	45.62	4.84
	45	41	55.08	4.42	53.76	4.57	52.18	4.71	51.31	4.80	50.62	4.87	48.78	5.01
	47	43	56.34	4.48	55.08	4.63	53.50	4.78	<b>52.63</b>	<b>4.86</b>	51.93	4.93	50.04	5.07
	50	46	56.50	4.45	55.36	4.59	53.99	4.72	53.21	4.79	52.58	4.85	50.81	4.98
	55	51	56.78	4.41	55.84	4.51	54.81	4.62	54.18	4.67	53.67	4.72	52.08	4.82
	60	56	57.05	4.36	56.31	4.44	55.62	4.52	55.14	4.56	54.76	4.59	53.36	4.66
	63	59	57.22	4.33	56.60	4.40	56.11	4.47	55.72	4.49	55.42	4.51	54.13	4.56
	68	64	57.39	4.30	56.88	4.36	56.60	4.41	56.31	4.42	56.08	4.43	54.90	4.47

TC = Total Capacity (kBtu/h).

PI = Power Input (kW).

Nominal Capacity as rated: 0 ft. above sea level with Piping Length as Main Pipe (16.4 ft.) + Branch pipe (98.4 ft.) = 115 ft.

0 ft. level difference between outdoor and indoor units.

Nominal heating capacity rating obtained with air entering the indoor unit at 70°F dry bulb (DB) and 60°F wet bulb (WB), and outdoor ambient conditions of 47°F dry bulb (DB) and 43°F wet bulb (WB).

# PERFORMANCE DATA

## Heating Capacity Tables

MULTI F  
MULTI F MAX

Table 142: LMU540HV Heating Capacity Table — Non-Ducted Indoor Units (continued).

Combination Capacity Index (kBtu/h[%])	Outdoor Air Temp.		Indoor Air Temp. °F DB											
			61		64		68		70		72		75	
	°F DB	°F WB	TC	PI	TC	PI	TC	PI	TC	PI	TC	PI	TC	PI
Non-Ducted Indoor Units 43 (80%)	0	-0.4	21.26	2.60	19.99	2.70	20.01	2.74	19.55	2.77	19.19	2.78	18.37	2.88
	5	4.5	25.60	2.72	24.40	2.82	24.05	2.88	23.54	2.91	23.13	2.93	22.20	3.03
	10	9	28.51	2.83	27.36	2.92	26.76	3.00	26.21	3.04	25.77	3.07	24.76	3.17
	17	15	31.71	2.97	30.61	3.06	29.73	3.16	<b>29.15</b>	<b>3.21</b>	28.68	3.25	27.58	3.35
	20	19	33.65	3.06	32.58	3.16	31.53	3.27	30.93	3.33	30.44	3.38	29.29	3.47
	25	23	36.89	3.23	35.79	3.33	34.55	3.45	33.89	3.52	33.37	3.58	32.11	3.67
	30	28	40.13	3.41	38.89	3.53	37.55	3.63	36.86	3.71	36.31	3.78	34.97	3.87
	35	32	43.37	3.59	41.99	3.72	40.56	3.82	39.83	3.91	39.24	3.98	37.83	4.07
	40	36	45.58	3.70	44.30	3.83	42.88	3.93	42.14	4.02	41.55	4.08	40.04	4.19
	45	41	48.34	3.83	47.18	3.96	45.79	4.08	45.03	4.15	44.42	4.21	42.81	4.34
	47	43	49.44	3.88	48.34	4.01	46.96	4.14	<b>46.19</b>	<b>4.21</b>	45.58	4.27	43.92	4.40
	50	46	49.59	3.86	48.59	3.97	47.39	4.09	46.70	4.15	46.15	4.20	44.59	4.31
	55	51	49.83	3.82	49.00	3.91	48.10	4.00	47.55	4.05	47.11	4.09	45.71	4.17
	60	56	50.07	3.78	49.42	3.85	48.81	3.92	48.40	3.95	48.06	3.97	46.83	4.03
	63	59	50.22	3.75	49.67	3.81	49.24	3.87	48.90	3.89	48.63	3.90	47.50	3.95
	68	64	50.36	3.73	49.92	3.77	49.67	3.82	49.42	3.83	49.21	3.84	48.19	3.87
	Non-Ducted Indoor Units 38 (70%)	0	-0.4	18.79	2.27	17.67	2.36	17.69	2.39	17.28	2.41	16.96	2.43	16.24
5		4.5	22.63	2.37	21.57	2.46	21.25	2.51	20.80	2.54	20.44	2.56	19.62	2.64
10		9	25.20	2.46	24.18	2.55	23.64	2.61	23.16	2.65	22.78	2.68	21.88	2.76
17		15	28.03	2.59	27.05	2.67	26.27	2.75	<b>25.76</b>	<b>2.80</b>	25.35	2.84	24.37	2.92
20		19	29.74	2.67	28.79	2.75	27.87	2.85	27.33	2.90	26.90	2.94	25.88	3.02
25		23	32.60	2.82	31.63	2.90	30.53	3.01	29.95	3.07	29.49	3.12	28.38	3.20
30		28	35.46	2.98	34.36	3.07	33.18	3.17	32.58	3.24	32.09	3.29	30.91	3.38
35		32	38.32	3.13	37.10	3.24	35.84	3.33	35.20	3.41	34.68	3.47	33.43	3.55
40		36	40.28	3.22	39.15	3.34	37.90	3.43	37.24	3.50	36.72	3.56	35.39	3.65
45		41	42.72	3.34	41.70	3.45	40.47	3.56	39.80	3.62	39.26	3.67	37.83	3.78
47		43	43.70	3.38	42.72	3.50	41.50	3.61	<b>40.82</b>	<b>3.67</b>	40.28	3.72	38.81	3.83
50		46	43.82	3.36	42.94	3.46	41.88	3.56	41.27	3.62	40.78	3.66	39.41	3.76
55		51	44.04	3.33	43.31	3.41	42.51	3.49	42.02	3.53	41.63	3.56	40.40	3.64
60		56	44.25	3.29	43.68	3.36	43.14	3.42	42.77	3.44	42.47	3.46	41.39	3.52
63		59	44.38	3.27	43.90	3.32	43.52	3.37	43.22	3.39	42.98	3.40	41.98	3.44
68		64	44.51	3.25	44.12	3.29	43.90	3.33	43.67	3.34	43.49	3.35	42.58	3.37
Non-Ducted Indoor Units 32 (60%)		0	-0.4	15.82	1.87	14.87	1.94	14.89	1.97	14.55	1.98	14.28	2.00	13.67
	5	4.5	19.05	1.95	18.16	2.02	17.90	2.06	17.52	2.09	17.21	2.10	16.52	2.18
	10	9	21.22	2.03	20.36	2.10	19.91	2.15	19.50	2.18	19.18	2.20	18.42	2.27
	17	15	23.60	2.13	22.78	2.20	22.12	2.27	<b>21.69</b>	<b>2.30</b>	21.34	2.33	20.52	2.40
	20	19	25.04	2.20	24.24	2.27	23.46	2.34	23.01	2.39	22.65	2.42	21.79	2.49
	25	23	27.45	2.32	26.63	2.39	25.71	2.48	25.22	2.53	24.83	2.57	23.90	2.63
	30	28	29.86	2.45	28.93	2.53	27.94	2.61	27.43	2.66	27.02	2.71	26.02	2.78
	35	32	32.27	2.58	31.24	2.67	30.18	2.74	29.64	2.80	29.20	2.85	28.15	2.92
	40	36	33.91	2.65	32.96	2.74	31.91	2.82	31.36	2.88	30.91	2.93	29.79	3.01
	45	41	35.97	2.75	35.11	2.84	34.07	2.93	33.51	2.98	33.06	3.02	31.86	3.11
	47	43	36.79	2.78	35.97	2.88	34.94	2.97	<b>34.37</b>	<b>3.02</b>	33.91	3.06	32.68	3.15
	50	46	36.90	2.77	36.15	2.85	35.26	2.93	34.75	2.98	34.34	3.01	33.18	3.09
	55	51	37.08	2.74	36.46	2.81	35.79	2.87	35.38	2.90	35.05	2.93	34.01	2.99
	60	56	37.26	2.71	36.77	2.76	36.32	2.81	36.01	2.83	35.76	2.85	34.85	2.89
	63	59	37.37	2.69	36.96	2.73	36.64	2.78	36.39	2.79	36.19	2.80	35.35	2.83
	68	64	37.48	2.67	37.15	2.71	36.96	2.74	36.77	2.75	36.62	2.75	35.86	2.78

TC = Total Capacity (kBtu/h).

PI = Power Input (kW).

Nominal Capacity as rated: 0 ft. above sea level with Piping Length as Main Pipe (16.4 ft.) + Branch pipe (98.4 ft.) = 115 ft.

0 ft. level difference between outdoor and indoor units.

Nominal heating capacity rating obtained with air entering the indoor unit at 70°F dry bulb (DB) and 60°F wet bulb (WB), and outdoor ambient conditions of 47°F dry bulb (DB) and 43°F wet bulb (WB).



Multi F and Multi F MAX Heat Pump System Engineering Manual

Table 143: LMU540HV Heating Capacity Table — Non-Ducted (continued) / Ducted Indoor Units.

Combination Capacity Index (kBtu/h[%])	Outdoor Air Temp.		Indoor Air Temp. °F DB											
			61		64		68		70		72		75	
	°F DB	°F WB	TC	PI	TC	PI	TC	PI	TC	PI	TC	PI	TC	PI
Non-Ducted Indoor Units 27 (50%)	0	-0.4	13.35	1.53	12.55	1.59	12.56	1.62	12.28	1.63	12.05	1.64	11.53	1.70
	5	4.5	16.08	1.60	15.32	1.66	15.10	1.69	14.78	1.71	14.52	1.73	13.94	1.79
	10	9	17.90	1.67	17.18	1.72	16.80	1.77	16.46	1.79	16.18	1.81	15.55	1.87
	17	15	19.91	1.75	19.22	1.81	18.67	1.86	<b>18.30</b>	<b>1.89</b>	18.01	1.92	17.31	1.97
	20	19	21.13	1.81	20.46	1.86	19.80	1.92	19.42	1.96	19.11	1.99	18.39	2.04
	25	23	23.16	1.90	22.47	1.96	21.69	2.03	21.28	2.07	20.95	2.11	20.16	2.16
	30	28	25.19	2.01	24.41	2.08	23.58	2.14	23.14	2.19	22.80	2.23	21.96	2.28
	35	32	27.23	2.12	26.36	2.19	25.46	2.25	25.00	2.30	24.64	2.34	23.75	2.40
	40	36	28.61	2.18	27.81	2.25	26.92	2.32	26.46	2.37	26.08	2.41	25.14	2.47
	45	41	30.35	2.26	29.62	2.33	28.75	2.40	28.27	2.45	27.89	2.48	26.88	2.55
	47	43	31.04	2.29	30.35	2.36	29.48	2.44	<b>29.00</b>	<b>2.48</b>	28.61	2.51	27.57	2.59
	50	46	31.13	2.27	30.51	2.34	29.75	2.41	29.32	2.44	28.97	2.47	28.00	2.54
	55	51	31.29	2.25	30.77	2.30	30.20	2.36	29.85	2.39	29.57	2.41	28.70	2.46
	60	56	31.44	2.22	31.03	2.27	30.65	2.31	30.38	2.33	30.17	2.34	29.40	2.38
	63	59	31.53	2.21	31.19	2.25	30.92	2.28	30.70	2.29	30.53	2.30	29.83	2.33
	68	64	31.62	2.20	31.34	2.22	31.19	2.25	31.03	2.26	30.90	2.26	30.25	2.28
	Non-Ducted Indoor Units 24 (40%)	0	-0.4	11.87	1.34	11.16	1.39	11.17	1.41	10.91	1.42	10.71	1.43	10.25
5		4.5	14.29	1.40	13.62	1.45	13.42	1.48	13.14	1.49	12.91	1.51	12.39	1.56
10		9	15.91	1.45	15.27	1.50	14.93	1.54	14.63	1.56	14.39	1.58	13.82	1.63
17		15	17.70	1.52	17.09	1.57	16.59	1.62	<b>16.27</b>	<b>1.65</b>	16.01	1.67	15.39	1.72
20		19	18.78	1.57	18.19	1.62	17.60	1.68	17.26	1.71	16.99	1.73	16.35	1.78
25		23	20.59	1.66	19.98	1.71	19.28	1.77	18.92	1.81	18.63	1.84	17.92	1.88
30		28	22.40	1.75	21.70	1.81	20.96	1.86	20.57	1.91	20.27	1.94	19.52	1.99
35		32	24.20	1.84	23.43	1.91	22.64	1.96	22.23	2.00	21.90	2.04	21.11	2.09
40		36	25.44	1.90	24.72	1.96	23.93	2.02	23.52	2.06	23.19	2.09	22.35	2.15
45		41	26.98	1.96	26.33	2.03	25.56	2.09	25.13	2.13	24.79	2.16	23.89	2.23
47		43	27.60	1.99	26.98	2.06	26.21	2.12	<b>25.78</b>	<b>2.16</b>	25.44	2.19	24.51	2.26
50		46	27.68	1.98	27.12	2.04	26.45	2.10	26.06	2.13	25.76	2.15	24.89	2.21
55		51	27.81	1.96	27.35	2.01	26.85	2.05	26.54	2.08	26.29	2.10	25.51	2.14
60		56	27.95	1.94	27.58	1.97	27.24	2.01	27.01	2.03	26.82	2.04	26.14	2.07
63		59	28.03	1.92	27.72	1.96	27.48	1.99	27.29	2.00	27.14	2.00	26.51	2.03
68		64	28.11	1.91	27.86	1.94	27.72	1.96	27.58	1.96	27.47	1.97	26.89	1.99
Ducted Indoor Units 73 (135%)		0	-0.4	32.46	3.83	30.59	3.98	30.54	4.04	29.85	4.07	29.30	4.10	28.06
	5	4.5	37.42	3.98	35.69	4.13	35.15	4.21	34.40	4.26	33.81	4.29	32.45	4.44
	10	9	40.75	4.12	39.10	4.26	38.23	4.37	37.45	4.43	36.83	4.48	35.38	4.62
	17	15	44.40	4.30	42.86	4.44	41.63	4.58	<b>40.81</b>	<b>4.66</b>	40.16	4.72	38.61	4.85
	20	19	46.62	4.43	45.14	4.56	43.68	4.72	42.84	4.81	42.17	4.88	40.57	5.01
	25	23	50.31	4.65	48.82	4.78	47.12	4.96	46.23	5.06	45.52	5.14	43.81	5.28
	30	28	54.02	4.88	52.35	5.04	50.55	5.20	49.62	5.31	48.88	5.41	47.08	5.54
	35	32	57.72	5.12	55.88	5.30	53.98	5.44	53.01	5.57	52.23	5.67	50.35	5.81
	40	36	60.66	5.27	58.96	5.45	57.08	5.61	56.09	5.73	55.30	5.82	53.30	5.97
	45	41	64.34	5.46	62.80	5.64	60.95	5.82	59.94	5.92	59.13	6.01	56.98	6.18
	47	43	65.81	5.53	64.34	5.72	62.50	5.90	<b>61.48</b>	<b>6.00</b>	60.66	6.08	58.46	6.26
	50	46	66.00	5.50	64.67	5.66	63.07	5.83	62.16	5.91	61.43	5.98	59.35	6.15
	55	51	66.33	5.44	65.23	5.57	64.02	5.71	63.29	5.77	62.70	5.82	60.84	5.95
	60	56	66.65	5.38	65.78	5.49	64.97	5.59	64.42	5.63	63.97	5.66	62.33	5.75
	63	59	66.84	5.35	66.11	5.43	65.54	5.51	65.09	5.54	64.73	5.56	63.23	5.63
	68	64	67.04	5.31	66.45	5.38	66.12	5.44	65.78	5.46	65.51	5.47	64.14	5.51

TC = Total Capacity (kBtu/h).

PI = Power Input (kW).

Nominal Capacity as rated: 0 ft. above sea level with Piping Length as Main Pipe (16.4 ft.) + Branch pipe (98.4 ft.) = 115 ft.

0 ft. level difference between outdoor and indoor units.

Nominal heating capacity rating obtained with air entering the indoor unit at 70°F dry bulb (DB) and 60°F wet bulb (WB), and outdoor ambient conditions of 47°F dry bulb (DB) and 43°F wet bulb (WB).

# PERFORMANCE DATA

MULTI F  
MULTI F MAX

## Heating Capacity Tables

Table 144: LMU540HV Heating Capacity Table — Ducted Indoor Units (continued).

Combination Capacity Index (kBtu/h[%])	Outdoor Air Temp.		Indoor Air Temp. °F DB											
			61		64		68		70		72		75	
	°F DB	°F WB	TC	PI	TC	PI	TC	PI	TC	PI	TC	PI	TC	PI
Ducted Indoor Units 70 (130%)	0	-0.4	32.16	3.79	30.32	3.94	30.27	4.00	29.58	4.03	29.04	4.06	27.81	4.20
	5	4.5	37.09	3.94	35.37	4.08	34.83	4.17	34.10	4.21	33.51	4.25	32.16	4.39
	10	9	40.38	4.08	38.75	4.22	37.89	4.32	37.12	4.38	36.50	4.43	35.07	4.57
	17	15	44.01	4.26	42.48	4.40	41.25	4.53	<b>40.44</b>	<b>4.61</b>	39.80	4.67	38.27	4.81
	20	19	46.20	4.38	44.73	4.52	43.29	4.67	42.46	4.76	41.79	4.83	40.21	4.96
	25	23	49.86	4.60	48.39	4.73	46.70	4.91	45.82	5.01	45.11	5.09	43.41	5.22
	30	28	53.54	4.83	51.88	4.99	50.10	5.15	49.18	5.26	48.44	5.35	46.66	5.49
	35	32	57.21	5.07	55.38	5.25	53.50	5.39	52.54	5.51	51.77	5.61	49.90	5.75
	40	36	60.12	5.22	58.43	5.40	56.57	5.55	55.59	5.67	54.80	5.76	52.82	5.91
	45	41	63.76	5.40	62.24	5.58	60.41	5.76	59.40	5.86	58.60	5.95	56.47	6.12
	47	43	65.22	5.48	63.76	5.66	61.94	5.84	<b>60.93</b>	<b>5.94</b>	60.12	6.02	57.93	6.20
	50	46	65.41	5.44	64.09	5.61	62.51	5.77	61.60	5.86	60.88	5.92	58.82	6.08
	55	51	65.73	5.39	64.64	5.52	63.45	5.65	62.72	5.71	62.14	5.76	60.30	5.89
	60	56	66.05	5.33	65.19	5.43	64.39	5.53	63.84	5.57	63.40	5.60	61.78	5.69
	63	59	66.24	5.29	65.52	5.38	64.96	5.46	64.51	5.49	64.15	5.51	62.66	5.57
	68	64	66.44	5.26	65.85	5.33	65.52	5.39	65.19	5.40	64.92	5.41	63.56	5.46
	Ducted Indoor Units 65 (120%)	0	-0.4	31.68	3.72	29.87	3.87	29.82	3.92	29.14	3.96	28.60	3.98	27.40
5		4.5	36.53	3.87	34.84	4.01	34.31	4.09	33.59	4.14	33.01	4.17	31.68	4.31
10		9	39.78	4.00	38.18	4.14	37.32	4.24	36.57	4.30	35.96	4.35	34.54	4.49
17		15	43.35	4.18	41.84	4.32	40.64	4.45	<b>39.84</b>	<b>4.52</b>	39.20	4.58	37.70	4.72
20		19	45.51	4.30	44.06	4.43	42.65	4.59	41.83	4.67	41.17	4.74	39.61	4.87
25		23	49.12	4.51	47.66	4.65	46.00	4.82	45.13	4.92	44.44	5.00	42.77	5.13
30		28	52.74	4.75	51.10	4.90	49.35	5.05	48.44	5.16	47.72	5.25	45.96	5.38
35		32	56.35	4.98	54.56	5.15	52.70	5.29	51.75	5.41	50.99	5.51	49.15	5.64
40		36	59.22	5.12	57.56	5.30	55.72	5.45	54.76	5.56	53.99	5.65	52.03	5.80
45		41	62.81	5.30	61.31	5.48	59.50	5.65	58.52	5.75	57.73	5.84	55.63	6.01
47		43	64.25	5.38	62.81	5.55	61.02	5.73	<b>60.02</b>	<b>5.83</b>	59.22	5.91	57.07	6.09
50		46	64.44	5.34	63.14	5.50	61.57	5.66	60.68	5.75	59.97	5.81	57.94	5.97
55		51	64.75	5.29	63.68	5.42	62.50	5.54	61.78	5.61	61.21	5.66	59.40	5.78
60		56	65.07	5.23	64.22	5.33	63.43	5.43	62.89	5.47	62.45	5.50	60.85	5.59
63		59	65.25	5.20	64.54	5.28	63.98	5.36	63.55	5.39	63.20	5.41	61.73	5.47
68		64	65.44	5.16	64.87	5.23	64.55	5.29	64.22	5.30	63.95	5.31	62.61	5.36
Ducted Indoor Units 59 (110%)		0	-0.4	31.10	3.63	29.32	3.77	29.27	3.83	28.61	3.86	28.08	3.89	26.90
	5	4.5	35.86	3.78	34.20	3.91	33.68	3.99	32.97	4.04	32.40	4.07	31.10	4.21
	10	9	39.05	3.91	37.48	4.04	36.64	4.14	35.90	4.20	35.30	4.24	33.91	4.38
	17	15	42.56	4.08	41.08	4.21	39.89	4.34	<b>39.11</b>	<b>4.42</b>	38.48	4.47	37.00	4.60
	20	19	44.68	4.20	43.26	4.33	41.86	4.48	41.06	4.56	40.42	4.63	38.88	4.75
	25	23	48.22	4.41	46.79	4.53	45.16	4.70	44.31	4.80	43.62	4.88	41.98	5.00
	30	28	51.77	4.63	50.17	4.78	48.44	4.93	47.56	5.04	46.84	5.13	45.12	5.26
	35	32	55.32	4.86	53.56	5.03	51.73	5.16	50.80	5.28	50.06	5.38	48.25	5.51
	40	36	58.14	5.00	56.50	5.17	54.70	5.32	53.75	5.43	53.00	5.52	51.08	5.66
	45	41	61.66	5.18	60.19	5.35	58.41	5.51	57.44	5.62	56.67	5.70	54.61	5.86
	47	43	63.07	5.25	61.66	5.42	59.90	5.59	<b>58.92</b>	<b>5.69</b>	58.14	5.77	56.02	5.94
	50	46	63.26	5.21	61.98	5.37	60.45	5.53	59.57	5.61	58.87	5.68	56.88	5.83
	55	51	63.56	5.16	62.51	5.29	61.36	5.41	60.65	5.47	60.09	5.52	58.31	5.64
	60	56	63.87	5.10	63.04	5.20	62.27	5.30	61.73	5.34	61.31	5.37	59.74	5.45
	63	59	64.06	5.07	63.36	5.15	62.81	5.23	62.38	5.26	62.04	5.28	60.60	5.34
	68	64	64.24	5.04	63.68	5.10	63.36	5.16	63.04	5.18	62.78	5.19	61.47	5.23

TC = Total Capacity (kBtu/h).

PI = Power Input (kW).

Nominal Capacity as rated: 0 ft. above sea level with Piping Length as Main Pipe (16.4 ft.) + Branch pipe (98.4 ft.) = 115 ft.

0 ft. level difference between outdoor and indoor units.

Nominal heating capacity rating obtained with air entering the indoor unit at 70°F dry bulb (DB) and 60°F wet bulb (WB), and outdoor ambient conditions of 47°F dry bulb (DB) and 43°F wet bulb (WB).



Multi F and Multi F MAX Heat Pump System Engineering Manual

Table 145: LMU540HV Heating Capacity Table — Ducted Indoor Units (continued).

Combination Capacity Index (kBtu/h[%])	Outdoor Air Temp.		Indoor Air Temp. °F DB											
			61		64		68		70		72		75	
	°F DB	°F WB	TC	PI	TC	PI	TC	PI	TC	PI	TC	PI	TC	PI
Ducted Indoor Units 54 (100%)	0	-0.4	30.62	3.56	28.86	3.70	28.81	3.75	28.16	3.79	27.64	3.81	26.48	3.95
	5	4.5	35.30	3.70	33.67	3.84	33.16	3.92	32.46	3.96	31.90	3.99	30.61	4.13
	10	9	38.44	3.83	36.89	3.96	36.07	4.06	35.33	4.12	34.75	4.16	33.38	4.29
	17	15	41.89	4.00	40.43	4.13	39.27	4.26	<b>38.50</b>	<b>4.33</b>	37.88	4.39	36.43	4.51
	20	19	43.98	4.12	42.58	4.24	41.21	4.39	40.42	4.47	39.78	4.54	38.27	4.66
	25	23	47.47	4.32	46.06	4.45	44.46	4.61	43.62	4.71	42.94	4.78	41.33	4.91
	30	28	50.96	4.54	49.38	4.69	47.69	4.84	46.81	4.94	46.11	5.03	44.42	5.15
	35	32	54.45	4.76	52.72	4.93	50.93	5.06	50.01	5.18	49.28	5.27	47.50	5.40
	40	36	57.23	4.90	55.62	5.07	53.85	5.21	52.92	5.32	52.17	5.41	50.28	5.56
	45	41	60.70	5.08	59.25	5.25	57.50	5.41	56.55	5.51	55.78	5.59	53.76	5.75
	47	43	62.09	5.15	60.70	5.32	58.96	5.49	<b>58.00</b>	<b>5.58</b>	57.23	5.66	55.15	5.83
	50	46	62.27	5.11	61.01	5.27	59.50	5.42	58.64	5.50	57.95	5.57	55.99	5.72
	55	51	62.57	5.06	61.53	5.18	60.40	5.31	59.70	5.37	59.15	5.42	57.40	5.53
	60	56	62.88	5.00	62.06	5.10	61.29	5.20	60.77	5.23	60.35	5.27	58.81	5.35
	63	59	63.06	4.97	62.37	5.05	61.83	5.13	61.41	5.15	61.07	5.18	59.65	5.24
	68	64	63.24	4.94	62.69	5.00	62.37	5.06	62.05	5.08	61.80	5.09	60.51	5.13
Ducted Indoor Units 49 (90%)	0	-0.4	27.78	3.22	26.19	3.34	26.14	3.39	25.55	3.42	25.08	3.44	24.02	3.57
	5	4.5	32.03	3.34	30.55	3.47	30.09	3.54	29.45	3.58	28.94	3.61	27.78	3.73
	10	9	34.88	3.46	33.48	3.58	32.73	3.67	32.06	3.72	31.53	3.76	30.29	3.88
	17	15	38.01	3.62	36.69	3.73	35.63	3.85	<b>34.94</b>	<b>3.91</b>	34.38	3.96	33.05	4.08
	20	19	39.91	3.72	38.64	3.83	37.39	3.97	36.68	4.04	36.10	4.10	34.73	4.21
	25	23	43.07	3.90	41.79	4.02	40.34	4.17	39.58	4.25	38.97	4.32	37.50	4.43
	30	28	46.24	4.10	44.81	4.24	43.27	4.37	42.48	4.46	41.84	4.54	40.31	4.66
	35	32	49.41	4.30	47.84	4.46	46.21	4.57	45.38	4.68	44.72	4.76	43.10	4.88
	40	36	51.93	4.43	50.47	4.58	48.86	4.71	48.02	4.81	47.34	4.89	45.62	5.02
	45	41	55.08	4.58	53.76	4.74	52.18	4.88	51.31	4.97	50.62	5.05	48.78	5.19
	47	43	56.34	4.65	55.08	4.80	53.50	4.95	<b>52.63</b>	<b>5.04</b>	51.93	5.11	50.04	5.26
	50	46	56.50	4.62	55.36	4.76	53.99	4.89	53.21	4.97	52.58	5.03	50.81	5.16
	55	51	56.78	4.57	55.84	4.68	54.81	4.79	54.18	4.85	53.67	4.89	52.08	5.00
	60	56	57.05	4.52	56.31	4.61	55.62	4.69	55.14	4.73	54.76	4.76	53.36	4.83
	63	59	57.22	4.49	56.60	4.56	56.11	4.63	55.72	4.66	55.42	4.67	54.13	4.73
	68	64	57.39	4.46	56.88	4.52	56.60	4.57	56.31	4.58	56.08	4.59	54.90	4.63
Ducted Indoor Units 43 (80%)	0	-0.4	24.38	2.80	22.98	2.90	22.95	2.95	22.43	2.97	22.01	2.99	21.08	3.10
	5	4.5	28.11	2.91	26.81	3.01	26.41	3.07	25.85	3.11	25.40	3.13	24.38	3.24
	10	9	30.61	3.01	29.38	3.11	28.72	3.19	28.14	3.23	27.67	3.27	26.58	3.37
	17	15	33.36	3.14	32.20	3.24	31.27	3.34	<b>30.66</b>	<b>3.40</b>	30.17	3.44	29.01	3.54
	20	19	35.03	3.23	33.91	3.33	32.82	3.45	32.19	3.51	31.68	3.56	30.48	3.66
	25	23	37.80	3.39	36.68	3.49	35.40	3.62	34.73	3.69	34.20	3.75	32.91	3.85
	30	28	40.58	3.57	39.33	3.68	37.98	3.80	37.28	3.88	36.72	3.95	35.37	4.05
	35	32	43.37	3.74	41.99	3.87	40.56	3.97	39.83	4.06	39.24	4.14	37.83	4.24
	40	36	45.58	3.85	44.30	3.98	42.88	4.09	42.14	4.18	41.55	4.25	40.04	4.36
	45	41	48.34	3.98	47.18	4.12	45.79	4.25	45.03	4.32	44.42	4.38	42.81	4.51
	47	43	49.44	4.04	48.34	4.17	46.96	4.31	<b>46.19</b>	<b>4.38</b>	45.58	4.44	43.92	4.57
	50	46	49.59	4.01	48.59	4.13	47.39	4.25	46.70	4.32	46.15	4.37	44.59	4.49
	55	51	49.83	3.97	49.00	4.07	48.10	4.17	47.55	4.21	47.11	4.25	45.71	4.34
	60	56	50.07	3.93	49.42	4.00	48.81	4.08	48.40	4.11	48.06	4.13	46.83	4.20
	63	59	50.22	3.90	49.67	3.97	49.24	4.03	48.90	4.05	48.63	4.06	47.50	4.11
	68	64	50.36	3.88	49.92	3.93	49.67	3.97	49.42	3.98	49.21	3.99	48.19	4.03

TC = Total Capacity (kBtu/h).

PI = Power Input (kW).

Nominal Capacity as rated: 0 ft. above sea level with Piping Length as Main Pipe (16.4 ft.) + Branch pipe (98.4 ft.) = 115 ft.

0 ft. level difference between outdoor and indoor units.

Nominal heating capacity rating obtained with air entering the indoor unit at 70°F dry bulb (DB) and 60°F wet bulb (WB), and outdoor ambient conditions of 47°F dry bulb (DB) and 43°F wet bulb (WB).

# PERFORMANCE DATA

## Heating Capacity Tables

MULTI F  
MULTI F MAX

Table 146: LMU540HV Heating Capacity Table — Ducted Indoor Units (continued).

Combination Capacity Index (kBtu/h[%])	Outdoor Air Temp.		Indoor Air Temp. °F DB											
			61		64		68		70		72		75	
	°F DB	°F WB	TC	PI	TC	PI	TC	PI	TC	PI	TC	PI	TC	PI
Ducted Indoor Units 38 (70%)	0	-0.4	21.55	2.45	20.31	2.55	20.28	2.58	19.82	2.61	19.45	2.62	18.63	2.72
	5	4.5	24.85	2.55	23.70	2.64	23.34	2.69	22.84	2.72	22.45	2.75	21.54	2.84
	10	9	27.05	2.64	25.96	2.73	25.38	2.80	24.87	2.83	24.46	2.86	23.49	2.95
	17	15	29.48	2.76	28.46	2.84	27.64	2.93	<b>27.10</b>	<b>2.98</b>	26.66	3.02	25.64	3.11
	20	19	30.95	2.83	29.97	2.92	29.00	3.02	28.45	3.08	28.00	3.12	26.94	3.21
	25	23	33.41	2.97	32.42	3.06	31.29	3.18	30.70	3.24	30.22	3.29	29.09	3.38
	30	28	35.87	3.13	34.76	3.23	33.56	3.33	32.95	3.40	32.45	3.46	31.26	3.55
	35	32	38.32	3.28	37.10	3.39	35.84	3.48	35.20	3.56	34.68	3.63	33.43	3.72
	40	36	40.28	3.37	39.15	3.49	37.90	3.59	37.24	3.66	36.72	3.72	35.39	3.82
	45	41	42.72	3.49	41.70	3.61	40.47	3.72	39.80	3.79	39.26	3.84	37.83	3.96
	47	43	43.70	3.54	42.72	3.66	41.50	3.77	<b>40.82</b>	<b>3.84</b>	40.28	3.89	38.81	4.01
	50	46	43.82	3.52	42.94	3.62	41.88	3.73	41.27	3.79	40.78	3.83	39.41	3.93
	55	51	44.04	3.48	43.31	3.57	42.51	3.65	42.02	3.69	41.63	3.73	40.40	3.81
	60	56	44.25	3.44	43.68	3.51	43.14	3.58	42.77	3.60	42.47	3.62	41.39	3.68
	63	59	44.38	3.42	43.90	3.48	43.52	3.53	43.22	3.55	42.98	3.56	41.98	3.60
	68	64	44.51	3.40	44.12	3.44	43.90	3.48	43.67	3.49	43.49	3.50	42.58	3.53
Ducted Indoor Units 32 (60%)	0	-0.4	18.14	2.03	17.10	2.11	17.07	2.14	16.69	2.16	16.38	2.17	15.69	2.25
	5	4.5	20.92	2.11	19.95	2.19	19.65	2.23	19.23	2.26	18.90	2.28	18.14	2.35
	10	9	22.78	2.18	21.86	2.26	21.37	2.32	20.94	2.35	20.59	2.37	19.78	2.45
	17	15	24.82	2.28	23.96	2.35	23.27	2.43	<b>22.81</b>	<b>2.47</b>	22.45	2.50	21.59	2.57
	20	19	26.06	2.35	25.23	2.42	24.42	2.50	23.95	2.55	23.58	2.59	22.68	2.66
	25	23	28.13	2.46	27.29	2.53	26.34	2.63	25.85	2.68	25.45	2.73	24.49	2.80
	30	28	30.20	2.59	29.26	2.67	28.26	2.76	27.74	2.82	27.33	2.87	26.32	2.94
	35	32	32.27	2.71	31.24	2.81	30.18	2.88	29.64	2.95	29.20	3.00	28.15	3.08
	40	36	33.91	2.79	32.96	2.89	31.91	2.97	31.36	3.03	30.91	3.08	29.79	3.17
	45	41	35.97	2.89	35.11	2.99	34.07	3.08	33.51	3.14	33.06	3.18	31.86	3.28
	47	43	36.79	2.93	35.97	3.03	34.94	3.13	<b>34.37</b>	<b>3.18</b>	33.91	3.22	32.68	3.32
	50	46	36.90	2.91	36.15	3.00	35.26	3.09	34.75	3.13	34.34	3.17	33.18	3.26
	55	51	37.08	2.88	36.46	2.95	35.79	3.02	35.38	3.06	35.05	3.09	34.01	3.15
	60	56	37.26	2.85	36.77	2.91	36.32	2.96	36.01	2.98	35.76	3.00	34.85	3.05
	63	59	37.37	2.83	36.96	2.88	36.64	2.92	36.39	2.94	36.19	2.95	35.35	2.98
	68	64	37.48	2.82	37.15	2.85	36.96	2.88	36.77	2.89	36.62	2.90	35.86	2.92
Ducted Indoor Units 27 (50%)	0	-0.4	15.31	1.69	14.43	1.75	14.41	1.78	14.08	1.79	13.82	1.80	13.24	1.87
	5	4.5	17.65	1.75	16.84	1.82	16.58	1.85	16.23	1.87	15.95	1.89	15.31	1.95
	10	9	19.22	1.81	18.45	1.87	18.03	1.92	17.67	1.95	17.37	1.97	16.69	2.03
	17	15	20.95	1.89	20.22	1.95	19.63	2.02	<b>19.25</b>	<b>2.05</b>	18.94	2.08	18.21	2.14
	20	19	21.99	1.95	21.29	2.01	20.61	2.08	20.21	2.12	19.89	2.15	19.14	2.21
	25	23	23.73	2.04	23.03	2.10	22.23	2.18	21.81	2.23	21.47	2.26	20.66	2.32
	30	28	25.48	2.15	24.69	2.22	23.84	2.29	23.41	2.34	23.06	2.38	22.21	2.44
	35	32	27.23	2.25	26.36	2.33	25.46	2.39	25.00	2.45	24.64	2.49	23.75	2.56
	40	36	28.61	2.32	27.81	2.40	26.92	2.47	26.46	2.52	26.08	2.56	25.14	2.63
	45	41	30.35	2.40	29.62	2.48	28.75	2.56	28.27	2.61	27.89	2.64	26.88	2.72
	47	43	31.04	2.43	30.35	2.51	29.48	2.60	<b>29.00</b>	<b>2.64</b>	28.61	2.68	27.57	2.76
	50	46	31.13	2.42	30.51	2.49	29.75	2.56	29.32	2.60	28.97	2.63	28.00	2.70
	55	51	31.29	2.39	30.77	2.45	30.20	2.51	29.85	2.54	29.57	2.56	28.70	2.62
	60	56	31.44	2.37	31.03	2.41	30.65	2.46	30.38	2.48	30.17	2.49	29.40	2.53
	63	59	31.53	2.35	31.19	2.39	30.92	2.43	30.70	2.44	30.53	2.45	29.83	2.48
	68	64	31.62	2.34	31.34	2.37	31.19	2.39	31.03	2.40	30.90	2.41	30.25	2.43

TC = Total Capacity (kBtu/h).

PI = Power Input (kW).

Nominal Capacity as rated: 0 ft. above sea level with Piping Length as Main Pipe (16.4 ft.) + Branch pipe (98.4 ft.) = 115 ft.

0 ft. level difference between outdoor and indoor units.

Nominal heating capacity rating obtained with air entering the indoor unit at 70°F dry bulb (DB) and 60°F wet bulb (WB), and outdoor ambient conditions of 47°F dry bulb (DB) and 43°F wet bulb (WB).



Multi F and Multi F MAX Heat Pump System Engineering Manual

Table 147: LMU540HV Heating Capacity Table — Ducted (continued) / Mixed Indoor Units.

Combination Capacity Index (kBtu/h[%])	Outdoor Air Temp.		Indoor Air Temp. °F DB											
			61		64		68		70		72		75	
	°F DB	°F WB	TC	PI	TC	PI	TC	PI	TC	PI	TC	PI	TC	PI
Ducted Indoor Units 24 (40%)	0	-0.4	13.61	1.47	12.83	1.53	12.81	1.55	12.52	1.57	12.29	1.58	11.77	1.63
	5	4.5	15.69	1.53	14.97	1.59	14.74	1.62	14.43	1.64	14.18	1.65	13.61	1.71
	10	9	17.09	1.59	16.40	1.64	16.03	1.68	15.71	1.70	15.44	1.72	14.84	1.78
	17	15	18.62	1.66	17.97	1.71	17.45	1.76	17.11	1.79	16.84	1.82	16.19	1.87
	20	19	19.55	1.70	18.93	1.76	18.32	1.82	17.97	1.85	17.68	1.88	17.01	1.93
	25	23	21.10	1.79	20.47	1.84	19.76	1.91	19.39	1.95	19.09	1.98	18.37	2.03
	30	28	22.65	1.88	21.95	1.94	21.20	2.00	20.81	2.05	20.50	2.08	19.74	2.13
	35	32	24.20	1.97	23.43	2.04	22.64	2.09	22.23	2.14	21.90	2.18	21.11	2.24
	40	36	25.44	2.03	24.72	2.10	23.93	2.16	23.52	2.20	23.19	2.24	22.35	2.30
	45	41	26.98	2.10	26.33	2.17	25.56	2.24	25.13	2.28	24.79	2.31	23.89	2.38
	47	43	27.60	2.13	26.98	2.20	26.21	2.27	25.78	2.31	25.44	2.34	24.51	2.41
	50	46	27.68	2.12	27.12	2.18	26.45	2.24	26.06	2.28	25.76	2.30	24.89	2.37
	55	51	27.81	2.09	27.35	2.15	26.85	2.20	26.54	2.22	26.29	2.24	25.51	2.29
	60	56	27.95	2.07	27.58	2.11	27.24	2.15	27.01	2.17	26.82	2.18	26.14	2.21
	63	59	28.03	2.06	27.72	2.09	27.48	2.12	27.29	2.13	27.14	2.14	26.51	2.17
	68	64	28.11	2.05	27.86	2.07	27.72	2.10	27.58	2.10	27.47	2.11	26.89	2.12
Mixed Indoor Units 73 (135%)	0	-0.4	30.38	3.78	28.60	3.93	28.59	3.98	27.94	4.02	27.42	4.04	26.26	4.19
	5	4.5	35.75	3.94	34.09	4.08	33.58	4.16	32.87	4.21	32.30	4.25	31.00	4.39
	10	9	39.35	4.08	37.76	4.22	36.92	4.33	36.17	4.39	35.57	4.43	34.17	4.57
	17	15	43.31	4.27	41.80	4.41	40.60	4.55	39.80	4.62	39.17	4.68	37.66	4.82
	20	19	45.71	4.40	44.25	4.54	42.83	4.69	42.00	4.78	41.35	4.85	39.77	4.98
	25	23	49.70	4.63	48.23	4.76	46.55	4.94	45.67	5.04	44.97	5.12	43.28	5.26
	30	28	53.71	4.88	52.05	5.04	50.26	5.19	49.34	5.31	48.60	5.40	46.82	5.53
	35	32	57.72	5.12	55.88	5.30	53.98	5.44	53.01	5.57	52.23	5.67	50.35	5.81
	40	36	60.66	5.27	58.96	5.45	57.08	5.61	56.09	5.73	55.30	5.82	53.30	5.97
	45	41	64.34	5.46	62.80	5.64	60.95	5.82	59.94	5.92	59.13	6.01	56.98	6.18
	47	43	65.81	5.53	64.34	5.72	62.50	5.90	61.48	6.00	60.66	6.08	58.46	6.26
	50	46	66.00	5.50	64.67	5.66	63.07	5.83	62.16	5.91	61.43	5.98	59.35	6.15
	55	51	66.33	5.44	65.23	5.57	64.02	5.71	63.29	5.77	62.70	5.82	60.84	5.95
	60	56	66.65	5.38	65.78	5.49	64.97	5.59	64.42	5.63	63.97	5.66	62.33	5.75
	63	59	66.84	5.35	66.11	5.43	65.54	5.51	65.09	5.54	64.73	5.56	63.23	5.63
	68	64	67.04	5.31	66.45	5.38	66.12	5.44	65.78	5.46	65.51	5.47	64.14	5.51
Mixed Indoor Units 70 (130%)	0	-0.4	30.10	3.73	28.34	3.87	28.33	3.93	27.69	3.96	27.17	3.99	26.02	4.13
	5	4.5	35.43	3.88	33.78	4.03	33.28	4.11	32.58	4.15	32.01	4.19	30.72	4.33
	10	9	39.00	4.03	37.42	4.17	36.59	4.27	35.85	4.33	35.25	4.37	33.86	4.51
	17	15	42.92	4.22	41.43	4.35	40.24	4.49	39.45	4.56	38.82	4.62	37.32	4.76
	20	19	45.30	4.34	43.86	4.48	42.44	4.63	41.63	4.72	40.98	4.79	39.42	4.92
	25	23	49.26	4.57	47.80	4.70	46.14	4.88	45.26	4.98	44.57	5.05	42.89	5.19
	30	28	53.23	4.81	51.59	4.97	49.81	5.12	48.90	5.23	48.17	5.33	46.40	5.46
	35	32	57.21	5.05	55.38	5.23	53.50	5.37	52.54	5.49	51.77	5.59	49.90	5.73
	40	36	60.12	5.20	58.43	5.38	56.57	5.53	55.59	5.65	54.80	5.74	52.82	5.89
	45	41	63.76	5.39	62.24	5.57	60.41	5.74	59.40	5.84	58.60	5.93	56.47	6.10
	47	43	65.22	5.46	63.76	5.64	61.94	5.82	60.93	5.92	60.12	6.00	57.93	6.18
	50	46	65.41	5.42	64.09	5.59	62.51	5.75	61.60	5.84	60.88	5.90	58.82	6.06
	55	51	65.73	5.37	64.64	5.50	63.45	5.63	62.72	5.69	62.14	5.75	60.30	5.87
	60	56	66.05	5.31	65.19	5.41	64.39	5.51	63.84	5.55	63.40	5.59	61.78	5.67
	63	59	66.24	5.28	65.52	5.36	64.96	5.44	64.51	5.47	64.15	5.49	62.66	5.56
	68	64	66.44	5.24	65.85	5.31	65.52	5.37	65.19	5.38	64.92	5.40	63.56	5.44

TC = Total Capacity (kBtu/h).

PI = Power Input (kW).

Nominal Capacity as rated: 0 ft. above sea level with Piping Length as Main Pipe (16.4 ft.) + Branch pipe (98.4 ft.) = 115 ft.

0 ft. level difference between outdoor and indoor units.

Nominal heating capacity rating obtained with air entering the indoor unit at 70°F dry bulb (DB) and 60°F wet bulb (WB), and outdoor ambient conditions of 47°F dry bulb (DB) and 43°F wet bulb (WB).

# PERFORMANCE DATA

## Heating Capacity Tables

MULTI F  
MULTI F MAX

Table 148: LMU540HV Heating Capacity Table —Mixed Indoor Units (continued).

Combination Capacity Index (kBtu/h[%])	Outdoor Air Temp.		Indoor Air Temp. °F DB												
			61		64		68		70		72		75		
	°F DB	°F WB	TC	PI	TC	PI	TC	PI	TC	PI	TC	PI	TC	PI	
Mixed Indoor Units 65 (120%)	0	-0.4	29.65	3.65	27.92	3.79	27.91	3.84	27.27	3.88	26.77	3.90	25.64	4.04	
	5	4.5	34.90	3.80	33.28	3.94	32.78	4.02	32.09	4.06	31.53	4.10	30.26	4.24	
	10	9	38.42	3.94	36.86	4.07	36.05	4.18	35.31	4.23	34.73	4.28	33.36	4.41	
	17	15	42.28	4.12	40.81	4.26	39.63	4.39	<b>38.86</b>	<b>4.46</b>	38.24	4.52	36.77	4.65	
	20	19	44.62	4.25	43.20	4.38	41.81	4.53	41.01	4.61	40.36	4.68	38.83	4.81	
	25	23	48.52	4.47	47.09	4.60	45.45	4.77	44.59	4.87	43.90	4.94	42.25	5.07	
	30	28	52.44	4.70	50.82	4.86	49.07	5.01	48.17	5.12	47.45	5.21	45.71	5.34	
	35	32	56.35	4.94	54.56	5.12	52.70	5.25	51.75	5.37	50.99	5.47	49.15	5.60	
	40	36	59.22	5.09	57.56	5.26	55.72	5.41	54.76	5.52	53.99	5.62	52.03	5.76	
	45	41	62.81	5.27	61.31	5.44	59.50	5.61	58.52	5.71	57.73	5.80	55.63	5.96	
	47	43	64.25	5.34	62.81	5.52	61.02	5.69	<b>60.02</b>	<b>5.79</b>	59.22	5.87	57.07	6.04	
	50	46	64.44	5.31	63.14	5.46	61.57	5.62	60.68	5.71	59.97	5.77	57.94	5.93	
	55	51	64.75	5.25	63.68	5.38	62.50	5.51	61.78	5.57	61.21	5.62	59.40	5.74	
	60	56	65.07	5.19	64.22	5.29	63.43	5.39	62.89	5.43	62.45	5.46	60.85	5.55	
	63	59	65.25	5.16	64.54	5.24	63.98	5.32	63.55	5.35	63.20	5.37	61.73	5.43	
	68	64	65.44	5.13	64.87	5.19	64.55	5.25	64.22	5.27	63.95	5.28	62.61	5.32	
	Mixed Indoor Units 59 (110%)	0	-0.4	29.11	3.55	27.41	3.68	27.40	3.74	26.77	3.77	26.28	3.79	25.17	3.93
		5	4.5	34.26	3.69	32.67	3.83	32.18	3.91	31.50	3.95	30.96	3.98	29.71	4.12
10		9	37.71	3.83	36.19	3.96	35.38	4.06	34.66	4.12	34.09	4.16	32.75	4.29	
17		15	41.51	4.01	40.06	4.14	38.91	4.27	<b>38.15</b>	<b>4.34</b>	37.54	4.39	36.09	4.52	
20		19	43.80	4.13	42.41	4.26	41.04	4.40	40.26	4.49	39.62	4.55	38.12	4.68	
25		23	47.63	4.34	46.22	4.47	44.62	4.64	43.77	4.73	43.10	4.81	41.47	4.93	
30		28	51.48	4.57	49.88	4.73	48.17	4.87	47.29	4.98	46.58	5.06	44.87	5.19	
35		32	55.32	4.81	53.56	4.98	51.73	5.11	50.80	5.22	50.06	5.32	48.25	5.45	
40		36	58.14	4.95	56.50	5.12	54.70	5.26	53.75	5.37	53.00	5.46	51.08	5.60	
45		41	61.66	5.12	60.19	5.29	58.41	5.46	57.44	5.56	56.67	5.64	54.61	5.80	
47		43	63.07	5.19	61.66	5.36	59.90	5.53	<b>58.92</b>	<b>5.63</b>	58.14	5.71	56.02	5.88	
50		46	63.26	5.16	61.98	5.31	60.45	5.47	59.57	5.55	58.87	5.62	56.88	5.77	
55		51	63.56	5.10	62.51	5.23	61.36	5.35	60.65	5.42	60.09	5.46	58.31	5.58	
60		56	63.87	5.05	63.04	5.15	62.27	5.24	61.73	5.28	61.31	5.31	59.74	5.40	
63		59	64.06	5.02	63.36	5.10	62.81	5.17	62.38	5.20	62.04	5.22	60.60	5.28	
68		64	64.24	4.98	63.68	5.05	63.36	5.11	63.04	5.12	62.78	5.13	61.47	5.17	
Mixed Indoor Units 54 (100%)		0	-0.4	28.66	3.46	26.98	3.59	26.97	3.65	26.36	3.68	25.87	3.70	24.77	3.83
		5	4.5	33.73	3.60	32.16	3.73	31.68	3.81	31.01	3.85	30.47	3.89	29.24	4.02
	10	9	37.12	3.73	35.62	3.86	34.83	3.96	34.12	4.01	33.56	4.06	32.24	4.19	
	17	15	40.86	3.91	39.44	4.04	38.30	4.16	<b>37.55</b>	<b>4.23</b>	36.95	4.29	35.53	4.41	
	20	19	43.12	4.03	41.75	4.15	40.40	4.29	39.63	4.37	39.01	4.44	37.52	4.56	
	25	23	46.89	4.24	45.50	4.36	43.92	4.52	43.09	4.61	42.42	4.69	40.83	4.81	
	30	28	50.67	4.46	49.11	4.61	47.42	4.75	46.55	4.85	45.85	4.94	44.17	5.06	
	35	32	54.45	4.69	52.72	4.85	50.93	4.98	50.01	5.09	49.28	5.19	47.50	5.31	
	40	36	57.23	4.82	55.62	4.99	53.85	5.13	52.92	5.24	52.17	5.32	50.28	5.47	
	45	41	60.70	4.99	59.25	5.16	57.50	5.32	56.55	5.42	55.78	5.50	53.76	5.66	
	47	43	62.09	5.06	60.70	5.23	58.96	5.40	<b>58.00</b>	<b>5.49</b>	57.23	5.56	55.15	5.73	
	50	46	62.27	5.03	61.01	5.18	59.50	5.33	58.64	5.41	57.95	5.48	55.99	5.62	
	55	51	62.57	4.98	61.53	5.10	60.40	5.22	59.70	5.28	59.15	5.33	57.40	5.44	
	60	56	62.88	4.92	62.06	5.02	61.29	5.11	60.77	5.15	60.35	5.18	58.81	5.26	
	63	59	63.06	4.89	62.37	4.97	61.83	5.05	61.41	5.07	61.07	5.09	59.65	5.15	
	68	64	63.24	4.86	62.69	4.92	62.37	4.98	62.05	4.99	61.80	5.00	60.51	5.05	

TC = Total Capacity (kBtu/h).

PI = Power Input (kW).

Nominal Capacity as rated: 0 ft. above sea level with Piping Length as Main Pipe (16.4 ft.) + Branch pipe (98.4 ft.) = 115 ft.

0 ft. level difference between outdoor and indoor units.

Nominal heating capacity rating obtained with air entering the indoor unit at 70°F dry bulb (DB) and 60°F wet bulb (WB), and outdoor ambient conditions of 47°F dry bulb (DB) and 43°F wet bulb (WB).

Table 149: LMU540HV Heating Capacity Table —Mixed Indoor Units (continued).

Combination Capacity Index (kBtu/h[%])	Outdoor Air Temp.		Indoor Air Temp. °F DB											
			61		64		68		70		72		75	
	°F DB	°F WB	TC	PI	TC	PI	TC	PI	TC	PI	TC	PI	TC	PI
Mixed Indoor Units 49 (90%)	0	-0.4	26.00	3.12	24.48	3.24	24.47	3.29	23.92	3.31	23.47	3.33	22.48	3.46
	5	4.5	30.60	3.25	29.18	3.37	28.75	3.43	28.14	3.47	27.65	3.50	26.54	3.62
	10	9	33.69	3.37	32.33	3.48	31.61	3.57	30.96	3.62	30.45	3.66	29.25	3.77
	17	15	37.07	3.53	35.78	3.64	34.75	3.75	<b>34.07</b>	<b>3.81</b>	33.53	3.86	32.24	3.98
	20	19	39.13	3.63	37.88	3.74	36.66	3.87	35.96	3.94	35.39	4.00	34.05	4.11
	25	23	42.55	3.82	41.29	3.93	39.85	4.08	39.10	4.16	38.50	4.23	37.05	4.34
	30	28	45.98	4.02	44.56	4.15	43.03	4.28	42.24	4.38	41.61	4.45	40.08	4.56
	35	32	49.41	4.22	47.84	4.38	46.21	4.49	45.38	4.59	44.72	4.68	43.10	4.79
	40	36	51.93	4.35	50.47	4.50	48.86	4.63	48.02	4.72	47.34	4.80	45.62	4.93
	45	41	55.08	4.50	53.76	4.65	52.18	4.80	51.31	4.89	50.62	4.96	48.78	5.10
	47	43	56.34	4.56	55.08	4.72	53.50	4.87	<b>52.63</b>	<b>4.95</b>	51.93	5.02	50.04	5.17
	50	46	56.50	4.54	55.36	4.67	53.99	4.81	53.21	4.88	52.58	4.94	50.81	5.07
	55	51	56.78	4.49	55.84	4.60	54.81	4.71	54.18	4.76	53.67	4.80	52.08	4.91
	60	56	57.05	4.44	56.31	4.53	55.62	4.61	55.14	4.64	54.76	4.67	53.36	4.74
	63	59	57.22	4.41	56.60	4.48	56.11	4.55	55.72	4.57	55.42	4.59	54.13	4.65
	68	64	57.39	4.38	56.88	4.44	56.60	4.49	56.31	4.50	56.08	4.51	54.90	4.55
	Mixed Indoor Units 43 (80%)	0	-0.4	22.82	2.71	21.49	2.81	21.48	2.86	20.99	2.88	20.60	2.90	19.73
5		4.5	26.86	2.82	25.61	2.92	25.23	2.98	24.69	3.02	24.27	3.04	23.29	3.15
10		9	29.56	2.93	28.37	3.03	27.74	3.10	27.18	3.14	26.72	3.18	25.67	3.28
17		15	32.54	3.06	31.41	3.16	30.50	3.26	<b>29.90</b>	<b>3.31</b>	29.43	3.36	28.29	3.45
20		19	34.34	3.16	33.25	3.25	32.18	3.36	31.56	3.43	31.06	3.48	29.88	3.57
25		23	37.34	3.32	36.24	3.41	34.98	3.54	34.31	3.61	33.78	3.67	32.51	3.77
30		28	40.36	3.49	39.11	3.61	37.76	3.72	37.07	3.80	36.52	3.87	35.17	3.96
35		32	43.37	3.67	41.99	3.80	40.56	3.90	39.83	3.99	39.24	4.06	37.83	4.16
40		36	45.58	3.78	44.30	3.91	42.88	4.02	42.14	4.10	41.55	4.17	40.04	4.28
45		41	48.34	3.91	47.18	4.04	45.79	4.17	45.03	4.24	44.42	4.30	42.81	4.43
47		43	49.44	3.97	48.34	4.10	46.96	4.23	<b>46.19</b>	<b>4.30</b>	45.58	4.36	43.92	4.49
50		46	49.59	3.94	48.59	4.06	47.39	4.18	46.70	4.24	46.15	4.29	44.59	4.40
55		51	49.83	3.90	49.00	3.99	48.10	4.09	47.55	4.14	47.11	4.17	45.71	4.26
60		56	50.07	3.86	49.42	3.93	48.81	4.00	48.40	4.03	48.06	4.06	46.83	4.12
63		59	50.22	3.83	49.67	3.89	49.24	3.95	48.90	3.97	48.63	3.99	47.50	4.04
68		64	50.36	3.81	49.92	3.86	49.67	3.90	49.42	3.91	49.21	3.92	48.19	3.95
Mixed Indoor Units 38 (70%)		0	-0.4	20.17	2.36	18.99	2.45	18.98	2.49	18.55	2.51	18.20	2.53	17.44
	5	4.5	23.74	2.46	22.63	2.55	22.30	2.60	21.82	2.63	21.45	2.65	20.58	2.74
	10	9	26.13	2.55	25.07	2.64	24.51	2.70	24.02	2.74	23.62	2.77	22.69	2.86
	17	15	28.76	2.67	27.75	2.76	26.96	2.84	<b>26.43</b>	<b>2.89</b>	26.00	2.93	25.00	3.01
	20	19	30.35	2.75	29.38	2.84	28.44	2.93	27.89	2.99	27.45	3.03	26.41	3.12
	25	23	33.00	2.89	32.02	2.98	30.91	3.09	30.32	3.15	29.86	3.20	28.73	3.29
	30	28	35.66	3.05	34.56	3.15	33.37	3.24	32.76	3.32	32.27	3.37	31.08	3.46
	35	32	38.32	3.20	37.10	3.31	35.84	3.40	35.20	3.48	34.68	3.54	33.43	3.63
	40	36	40.28	3.29	39.15	3.41	37.90	3.50	37.24	3.58	36.72	3.64	35.39	3.73
	45	41	42.72	3.41	41.70	3.53	40.47	3.63	39.80	3.70	39.26	3.75	37.83	3.86
	47	43	43.70	3.46	42.72	3.57	41.50	3.69	<b>40.82</b>	<b>3.75</b>	40.28	3.80	38.81	3.92
	50	46	43.82	3.44	42.94	3.54	41.88	3.64	41.27	3.70	40.78	3.74	39.41	3.84
	55	51	44.04	3.40	43.31	3.48	42.51	3.57	42.02	3.61	41.63	3.64	40.40	3.72
	60	56	44.25	3.36	43.68	3.43	43.14	3.49	42.77	3.52	42.47	3.54	41.39	3.59
	63	59	44.38	3.34	43.90	3.40	43.52	3.45	43.22	3.46	42.98	3.48	41.98	3.52
	68	64	44.51	3.32	44.12	3.36	43.90	3.40	43.67	3.41	43.49	3.42	42.58	3.45

TC = Total Capacity (kBtu/h).

PI = Power Input (kW).

Nominal Capacity as rated: 0 ft. above sea level with Piping Length as Main Pipe (16.4 ft.) + Branch pipe (98.4 ft.) = 115 ft.

0 ft. level difference between outdoor and indoor units.

Nominal heating capacity rating obtained with air entering the indoor unit at 70°F dry bulb (DB) and 60°F wet bulb (WB), and outdoor ambient conditions of 47°F dry bulb (DB) and 43°F wet bulb (WB).

# PERFORMANCE DATA

## Heating Capacity Tables

MULTI F  
MULTI F MAX

Table 150: LMU540HV Heating Capacity Table —Mixed Indoor Units (continued).

Combination Capacity Index (kBtu/h[%])	Outdoor Air Temp.		Indoor Air Temp. °F DB											
			61		64		68		70		72		75	
	°F DB	°F WB	TC	PI	TC	PI	TC	PI	TC	PI	TC	PI	TC	PI
Mixed Indoor Units 32 (60%)	0	-0.4	16.98	1.95	15.99	2.03	15.98	2.06	15.62	2.08	15.33	2.09	14.68	2.16
	5	4.5	19.99	2.03	19.06	2.11	18.77	2.15	18.38	2.17	18.06	2.19	17.33	2.27
	10	9	22.00	2.11	21.11	2.18	20.64	2.24	20.22	2.27	19.89	2.29	19.10	2.36
	17	15	24.21	2.21	23.37	2.28	22.70	2.35	<b>22.25</b>	<b>2.39</b>	21.90	2.42	21.05	2.49
	20	19	25.55	2.27	24.74	2.34	23.94	2.42	23.48	2.47	23.11	2.51	22.24	2.58
	25	23	27.79	2.39	26.96	2.46	26.03	2.55	25.53	2.61	25.14	2.65	24.19	2.72
	30	28	30.03	2.52	29.10	2.60	28.10	2.68	27.58	2.74	27.17	2.79	26.17	2.86
	35	32	32.27	2.65	31.24	2.74	30.18	2.81	29.64	2.88	29.20	2.93	28.15	3.00
	40	36	33.91	2.72	32.96	2.82	31.91	2.90	31.36	2.96	30.91	3.01	29.79	3.09
	45	41	35.97	2.82	35.11	2.91	34.07	3.00	33.51	3.06	33.06	3.10	31.86	3.19
	47	43	36.79	2.86	35.97	2.95	34.94	3.05	<b>34.37</b>	<b>3.10</b>	33.91	3.14	32.68	3.24
	50	46	36.90	2.84	36.15	2.93	35.26	3.01	34.75	3.06	34.34	3.09	33.18	3.18
	55	51	37.08	2.81	36.46	2.88	35.79	2.95	35.38	2.98	35.05	3.01	34.01	3.07
	60	56	37.26	2.78	36.77	2.83	36.32	2.89	36.01	2.91	35.76	2.93	34.85	2.97
	63	59	37.37	2.76	36.96	2.81	36.64	2.85	36.39	2.86	36.19	2.88	35.35	2.91
	68	64	37.48	2.74	37.15	2.78	36.96	2.81	36.77	2.82	36.62	2.83	35.86	2.85
Mixed Indoor Units 27 (50%)	0	-0.4	14.33	1.61	13.49	1.67	13.49	1.70	13.18	1.71	12.93	1.72	12.39	1.79
	5	4.5	16.86	1.68	16.08	1.74	15.84	1.78	15.50	1.80	15.24	1.81	14.62	1.87
	10	9	18.56	1.74	17.81	1.80	17.42	1.85	17.06	1.87	16.78	1.89	16.12	1.95
	17	15	20.43	1.82	19.72	1.88	19.15	1.94	<b>18.78</b>	<b>1.97</b>	18.47	2.00	17.76	2.06
	20	19	21.56	1.88	20.87	1.94	20.20	2.00	19.81	2.04	19.50	2.07	18.76	2.13
	25	23	23.45	1.97	22.75	2.03	21.96	2.11	21.54	2.15	21.21	2.19	20.41	2.24
	30	28	25.34	2.08	24.55	2.15	23.71	2.21	23.27	2.26	22.93	2.30	22.08	2.36
	35	32	27.23	2.18	26.36	2.26	25.46	2.32	25.00	2.38	24.64	2.42	23.75	2.48
	40	36	28.61	2.25	27.81	2.33	26.92	2.39	26.46	2.44	26.08	2.48	25.14	2.55
	45	41	30.35	2.33	29.62	2.41	28.75	2.48	28.27	2.53	27.89	2.56	26.88	2.64
	47	43	31.04	2.36	30.35	2.44	29.48	2.52	<b>29.00</b>	<b>2.56</b>	28.61	2.59	27.57	2.67
	50	46	31.13	2.35	30.51	2.42	29.75	2.49	29.32	2.52	28.97	2.55	28.00	2.62
	55	51	31.29	2.32	30.77	2.38	30.20	2.43	29.85	2.46	29.57	2.48	28.70	2.54
	60	56	31.44	2.30	31.03	2.34	30.65	2.38	30.38	2.40	30.17	2.42	29.40	2.45
	63	59	31.53	2.28	31.19	2.32	30.92	2.35	30.70	2.36	30.53	2.37	29.83	2.40
	68	64	31.62	2.27	31.34	2.30	31.19	2.32	31.03	2.33	30.90	2.33	30.25	2.35
Mixed Indoor Units 24 (40%)	0	-0.4	12.74	1.41	11.99	1.47	11.99	1.49	11.72	1.50	11.50	1.51	11.01	1.56
	5	4.5	14.99	1.47	14.29	1.52	14.08	1.55	13.78	1.57	13.54	1.59	13.00	1.64
	10	9	16.50	1.52	15.83	1.58	15.48	1.62	15.17	1.64	14.92	1.66	14.33	1.71
	17	15	18.16	1.60	17.53	1.65	17.02	1.70	<b>16.69</b>	<b>1.73</b>	16.42	1.75	15.79	1.80
	20	19	19.17	1.64	18.56	1.69	17.96	1.75	17.61	1.78	17.34	1.81	16.68	1.86
	25	23	20.84	1.73	20.22	1.78	19.52	1.85	19.15	1.88	18.86	1.91	18.15	1.96
	30	28	22.52	1.82	21.83	1.88	21.08	1.94	20.69	1.98	20.38	2.01	19.63	2.07
	35	32	24.20	1.91	23.43	1.98	22.64	2.03	22.23	2.08	21.90	2.12	21.11	2.17
	40	36	25.44	1.97	24.72	2.04	23.93	2.09	23.52	2.14	23.19	2.17	22.35	2.23
	45	41	26.98	2.04	26.33	2.11	25.56	2.17	25.13	2.21	24.79	2.24	23.89	2.31
	47	43	27.60	2.07	26.98	2.13	26.21	2.20	<b>25.78</b>	<b>2.24</b>	25.44	2.27	24.51	2.34
	50	46	27.68	2.05	27.12	2.11	26.45	2.18	26.06	2.21	25.76	2.23	24.89	2.29
	55	51	27.81	2.03	27.35	2.08	26.85	2.13	26.54	2.15	26.29	2.17	25.51	2.22
	60	56	27.95	2.01	27.58	2.05	27.24	2.09	27.01	2.10	26.82	2.11	26.14	2.15
	63	59	28.03	2.00	27.72	2.03	27.48	2.06	27.29	2.07	27.14	2.08	26.51	2.10
	68	64	28.11	1.98	27.86	2.01	27.72	2.03	27.58	2.04	27.47	2.04	26.89	2.06

TC = Total Capacity (kBtu/h).

PI = Power Input (kW).

Nominal Capacity as rated: 0 ft. above sea level with Piping Length as Main Pipe (16.4 ft.) + Branch pipe (98.4 ft.) = 115 ft.

0 ft. level difference between outdoor and indoor units.

Nominal heating capacity rating obtained with air entering the indoor unit at 70°F dry bulb (DB) and 60°F wet bulb (WB), and outdoor ambient conditions of 47°F dry bulb (DB) and 43°F wet bulb (WB).



Multi F and Multi F MAX Heat Pump System Engineering Manual

### Electrical Data

Table 151: LMU540HV Electrical Data.

Nominal Tons	Unit Model No.	Hertz	Voltage	Voltage Range (Min. to Max.)	MCA	MOP	Compressor Quantity	Compressor Motor RLA	Condenser Fan Motor(s)	
									Condenser Fan Quantity x kW	Condenser Fan Motor FLA
4.5	LMU540HV	60	208 - 230	187 - 253	26.4	40	1	18.5	2 x 0.12	1.25 x 2

Voltage tolerance is  $\pm 10\%$ .

Maximum allowable voltage unbalance is 2%.

RLA = Rated Load Amps.

MCA = Minimum Circuit Ampacity.

Maximum Overcurrent Protection (MOP) is calculated as follows: (Largest motor FLA x 2.25) + (Sum of other motor FLA) rounded down to the nearest standard fuse size.

### Acoustic Data

Figure 21: Sound Pressure Level Measurement Location.

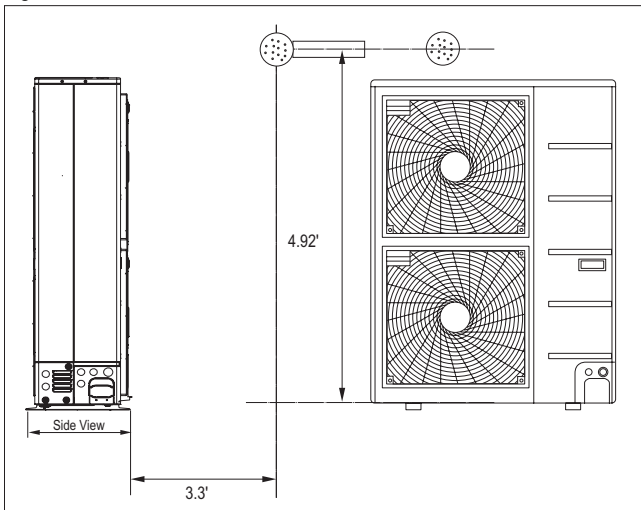

- Measurement taken 4.92' above finished floor, and at a distance of 3.3' from face of unit.
- Measurements taken with no attenuation and units operating at full load normal operating condition.
- Sound level will vary depending on a range of factors such as construction (acoustic absorption coefficient) of particular area in which the equipment is installed.
- Sound pressure levels are measured in dB(A)  $\pm 3$ .
- Tested in anechoic chamber per ISO Standard 3745.

Table 152: Sound Pressure Levels (dB[A]).

Model No.	Sound Pressure Levels (dB[A])	
	Cooling	Heating
LMU540HV	54	56

Figure 22: Sound Pressure Diagram.

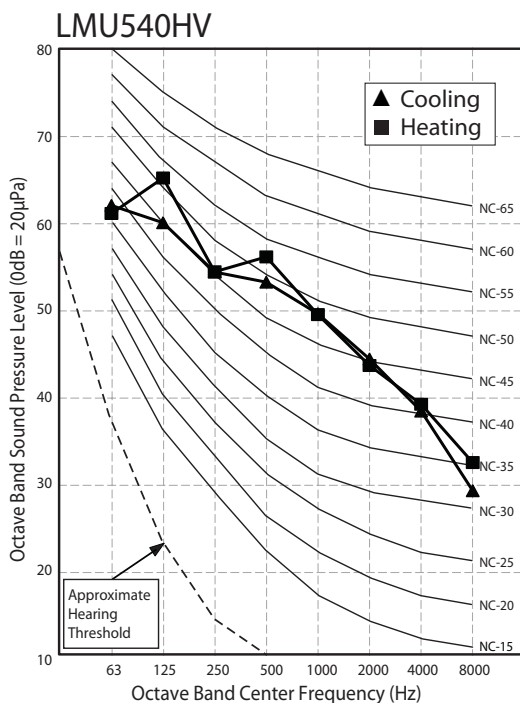

# MULTI F MAX OUTDOOR UNIT

MULTI F  
MULTI F MAX

## Refrigerant Flow Diagram

Figure 23: LMU540HV Refrigerant Flow Diagram.

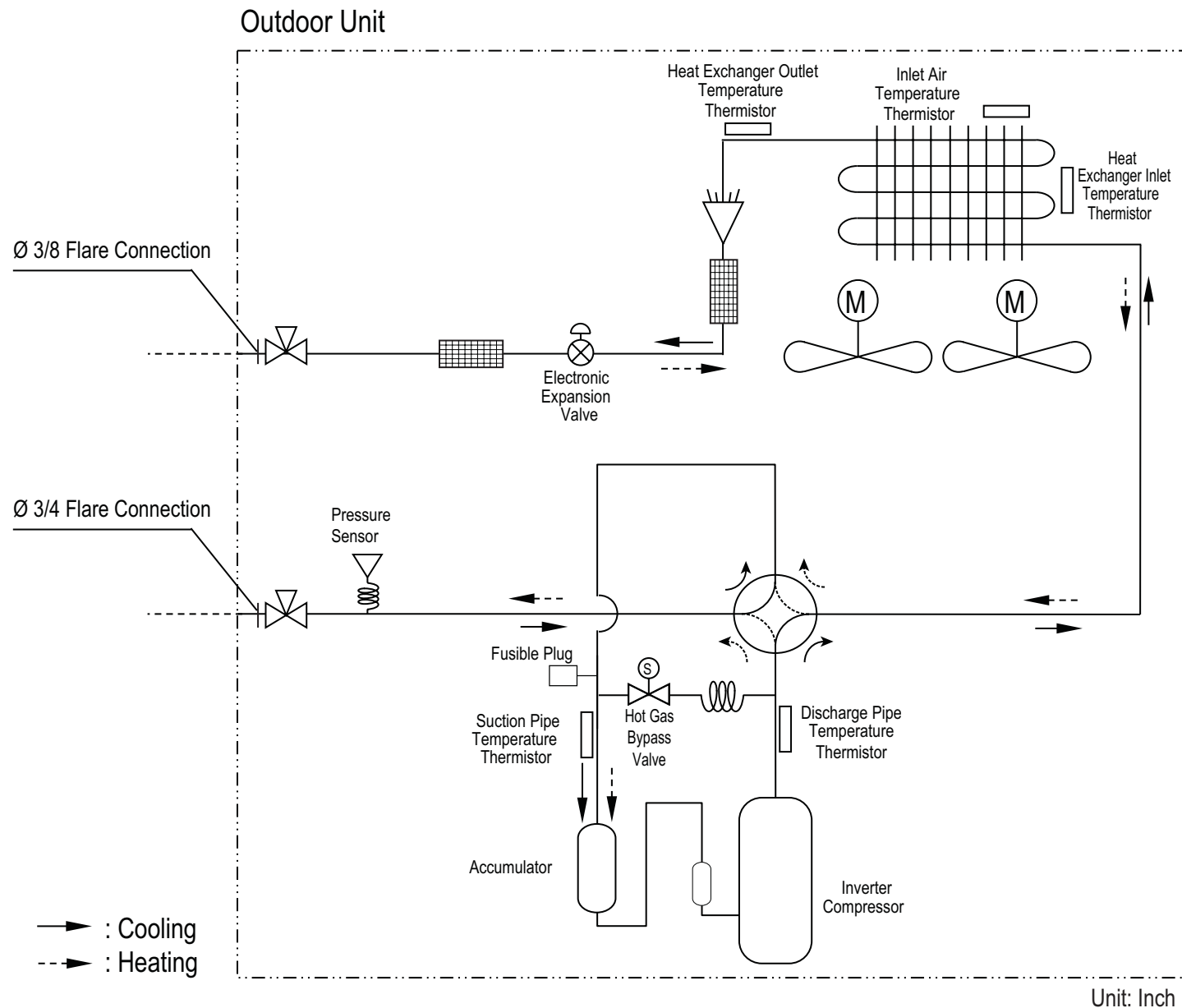
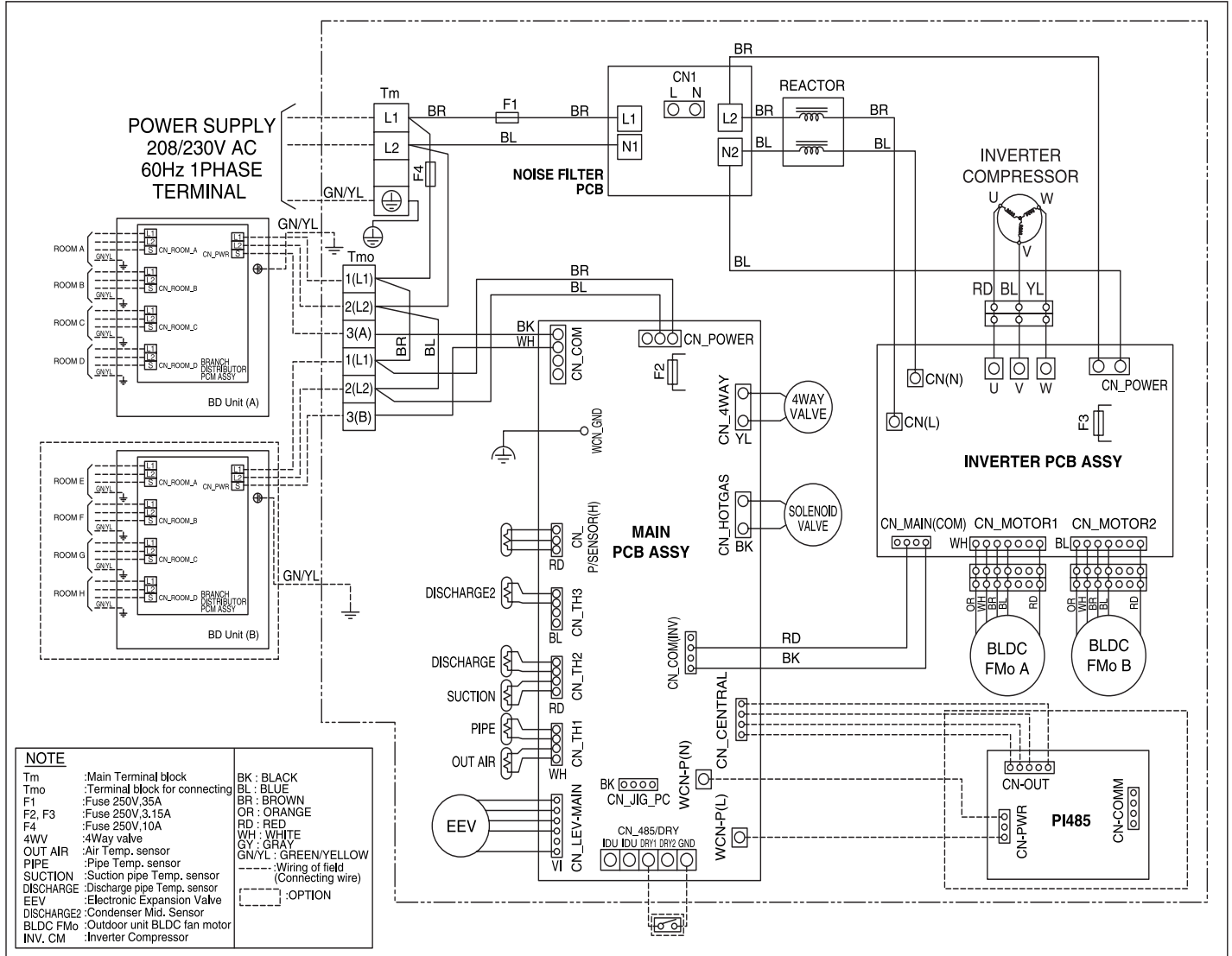

Table 153: LMU540HV Thermistor Details.

Description	PCB Connector
Heat Exchanger Inlet Temperature Thermistor	CN-TH3
Heat Exchanger Outlet Temperature Thermistor	CN-TH1
Inlet Air Temperature Thermistor	
Discharge Pipe Temperature Thermistor	CN-TH2
Suction Pipe Temperature Thermistor	
Pressure Sensor	CN-P/SENSOR(H)

Figure 24: LMU540HV Wiring Diagram.



# MULTI F MAX OUTDOOR UNIT

MULTI F  
MULTI F MAX

## Operation Ranges

Figure 25: LMU540HV Cooling and Heating Operation Ranges.

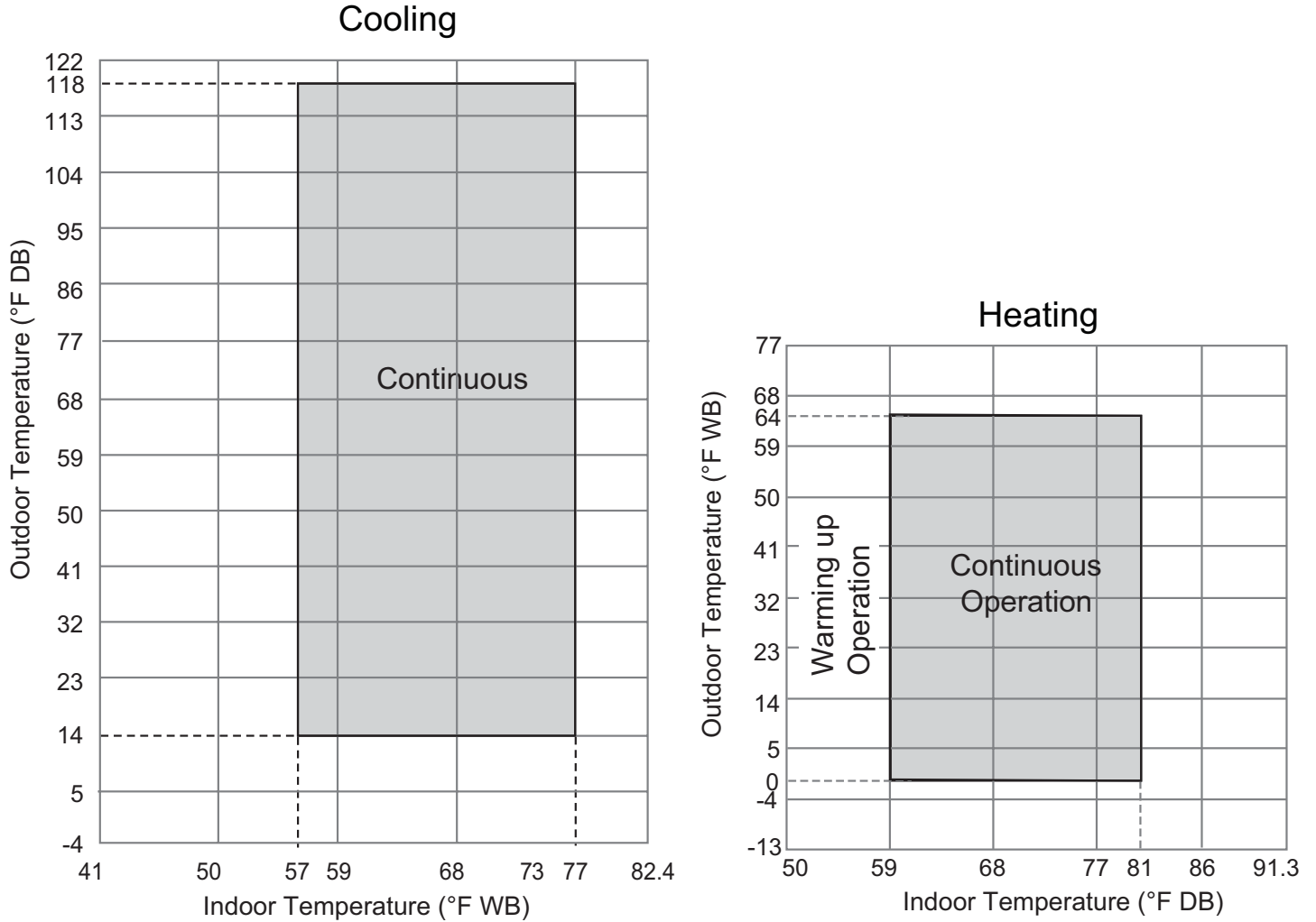

# MULTI F MAX BD UNIT DATA

**“Features and Benefits” on page 170**

**“Mechanical Specifications” on page 171**

**“General Data” on page 172**

**“Dimensions” on page 173**

**“Refrigerant Flow Diagram” on page 174**

**“Wiring Diagram” on page 175**

**“Y-Branch Accessory” on page 176**

**“Branch Distribution Unit Orientation” on page 177**

# MULTI F MAX BD UNIT

## Features and Benefits

MULTI F  
MULTI F MAX

The Branch Distribution (BD) unit is a required accessory of Multi F MAX inverter-driven heat pump systems. Choose from two (2) port, three (3) port, or four (4) port BD units.

Two (2) refrigerant pipes—one (1) liquid line and one (1) vapor line—run from the outdoor unit to the BD unit that is installed inside of a building. Two (2), three (3), or four (4) sets of refrigerant lines will run from the BD unit to the indoor units, depending on type of BD unit selected. A Multi F MAX system can include up to two BD units (installed with the use of the Y-branch accessory PMBL5620) that support a total of eight (8) indoor units (up to four [4] indoor units per BD unit).

Figure 26: Example of Multi F MAX Heat Pump Inverter System with two BD Units



## Branch Distribution Unit

### General

Branch distribution units are designed for use with LG Multi F MAX (LMU540HV) outdoor units, and are internally piped, wired, assembled and run-tested at the factory. The branch distribution unit is used as an intermediate refrigerant control device between the outdoor unit and the indoor units to effectively and efficiently control the heating or cooling operation of the system through the use of electronic expansion valves.

### Refrigerant System

System is designed for use with R410A refrigerant. All refrigerant lines from the outdoor unit to the branch distribution unit, and from the branch distribution unit to the indoor units, must be field insulated. The units may be connected to optional field-supplied and field-installed isolation valves for servicing without evacuating the entire system.

### Piping Capabilities

Maximum piping length from the branch distribution unit to the indoor unit is 49.2 equivalent feet. Maximum elevation difference between branch distribution unit and indoor unit is 32.8 feet. Maximum elevation difference between two parallel branch distribution units is 49.2 feet.

### Electrical

Each branch distribution unit is designed to operate using 208–230/60/1 power with voltage variances of  $\pm 10\%$ .

### Casing

The casing is designed to mount fully concealed above a finished ceiling, is manufactured of galvanized steel plate, and is internally insulated. Branch distribution units do not require a condensate drain.

### Port Assembly

Branch distribution units have a two-pipe system consisting of one vapor pipe and one liquid pipe. Units are available in a choice of two (PMBD3620), three (PMBD3630) or four ports (PMBD3640 and PMBD3641); branch distribution units include two, two-positioned solenoid valves per port. Each port for PMBD3620, PMBD3630, and PMBD3640 units connect to one indoor unit for a maximum nominal capacity of 24,000 Btu/h. For PMBD3641 units, ports A, B, C each connect to one indoor unit for a maximum nominal capacity of 24,000 Btu/h; port D connect to one indoor unit for a nominal capacity of 36,000 Btu/h. Maximum nominal capacity per branch distribution unit is 73,000 Btu/h. Two branch distribution units can be piped in parallel using accessory Y-branch kit PMBL5620.

### Controls

The unit is provided with factory-installed control boards and an integral microprocessor to communicate with the main control board in the outdoor unit. Communication between the branch distribution unit, the outdoor unit, and the indoor units is accomplished through a 18 AWG, four-core, stranded and shielded power / communication cable.

Figure 27: PMBD3620 Two-Port Branch Distribution Unit.



Figure 28: PMBD3630 Three-Port Branch Distribution Unit.



Figure 29: PMBD3640 and PMBD3641 Four-Port Branch Distribution Unit.



# MULTI F MAX BD UNIT

## General Data

MULTI F  
MULTI F MAX

Table 154: Multi F MAX BD Unit General Data.

Model Number	PMBD3620	PMBD3630	PMBD3640	PMBD3641
No. of Connectable Indoor Units <sup>1</sup>	1-2	1-3	1-4	1-4
Max. Nominal Capacity / Port (Btu/h) <sup>2</sup>	24,000	24,000	24,000	24,000 for A,B,C Ports; 36,000 for D Port
Max. Nominal Capacity / BD Unit (Btu/h)	48,000	72,000	73,000	73,000
Operation Temperature Range (°F DB)	0 ~ 122	0 ~ 122	0 ~ 122	0 ~ 122
<b>Unit Data</b>				
Refrigerant Type	R410A	R410A	R410A	R410A
Power Supply V, Ø, Hz	208-230, 1, 60	208-230, 1, 60	208-230, 1, 60	208-230, 1, 60
Power Input (W)	16	24	32	32
Rated Amps (A)	0.08	0.12	0.16	0.16
Dimensions W x H x D (in.)	17-3/32 x 6-13/32 x 10-23/32	17-3/32 x 6-13/32 x 10-23/32	17-3/32 x 6-13/32 x 10-23/32	17-3/32 x 6-13/32 x 10-23/32
Net Unit Weight (lbs.)	13	14.3	15.7	15.7
Shipping Weight (lbs.)	15	17	18	18
<b>Power Wiring / Communication Cables<sup>3</sup></b>				
From Outdoor Unit to BD Unit (Qty. x AWG) <sup>3</sup>	4 x 16	4 x 16	4 x 16	4 x 16
From BD Unit to Indoor Unit (Qty. x AWG) <sup>3</sup>	4 x 18	4 x 18	4 x 18	4 x 18
<b>Piping Connections</b>				
Outdoor Unit to BD Unit	Liquid (in., OD)	Ø3/8	Ø3/8	Ø3/8
	Vapor (in., OD)	Ø3/4	Ø3/4	Ø3/4
BD Unit to Indoor Units	Liquid (in., OD) x Qty.	Ø1/4 x 2	Ø1/4 x 3	Ø1/4 x 3 Ø3/8 x 1
	Vapor (in., OD) x Qty.	Ø3/8 x 2	Ø3/8 x 3	Ø3/8 x 3 Ø5/8 x 1
<b>Piping Lengths</b>				
Maximum Total System Piping (ft.) <sup>4</sup>	476	476	476	476
Maximum Main Pipe Length (Outdoor Unit to BD Units [ft.])	180	180	180	180
Total Branch Piping (BD Units to Indoor Units [ft.])	295	295	295	295
Maximum Branch Pipe Length Between BD Unit and Each Indoor Unit [ft.]	49	49	49	49
Maximum Outdoor Unit to Indoor Unit Pipe Length (ft.)	230	230	230	230
Piping Length (No Additional Refrigerant [ft.]; 16 ft. of Main Piping + 131 ft. of Branch Piping)	147	147	147	147
Maximum Elevation between BD Unit and Indoor Unit (ft.)	33	33	33	33
Maximum Elevation between BD Unit and BD Unit (ft.)	49	49	49	49

<sup>1</sup>At least one Branch Distribution Unit is required for system operation; a maximum of two can be installed per outdoor unit with use of Y-branch accessory (PMBL5620) To connect only one (1) indoor unit to a branch distribution unit, the system must include another branch distribution unit with at least one (1) connected indoor unit.

<sup>2</sup>Branch Distribution Unit can accommodate from one (1) indoor unit up to four (4) indoor units depending on the ports available on the Branch Distribution Unit.

<sup>3</sup>All power wiring / communication cables to be four-conductor, stranded, shielded, and must comply with applicable local and national codes.

<sup>4</sup>Piping lengths are equivalent.

Figure 30: PMBD3620, PMBD3630, PMBD3640, and PMBD3641 External Dimensions.

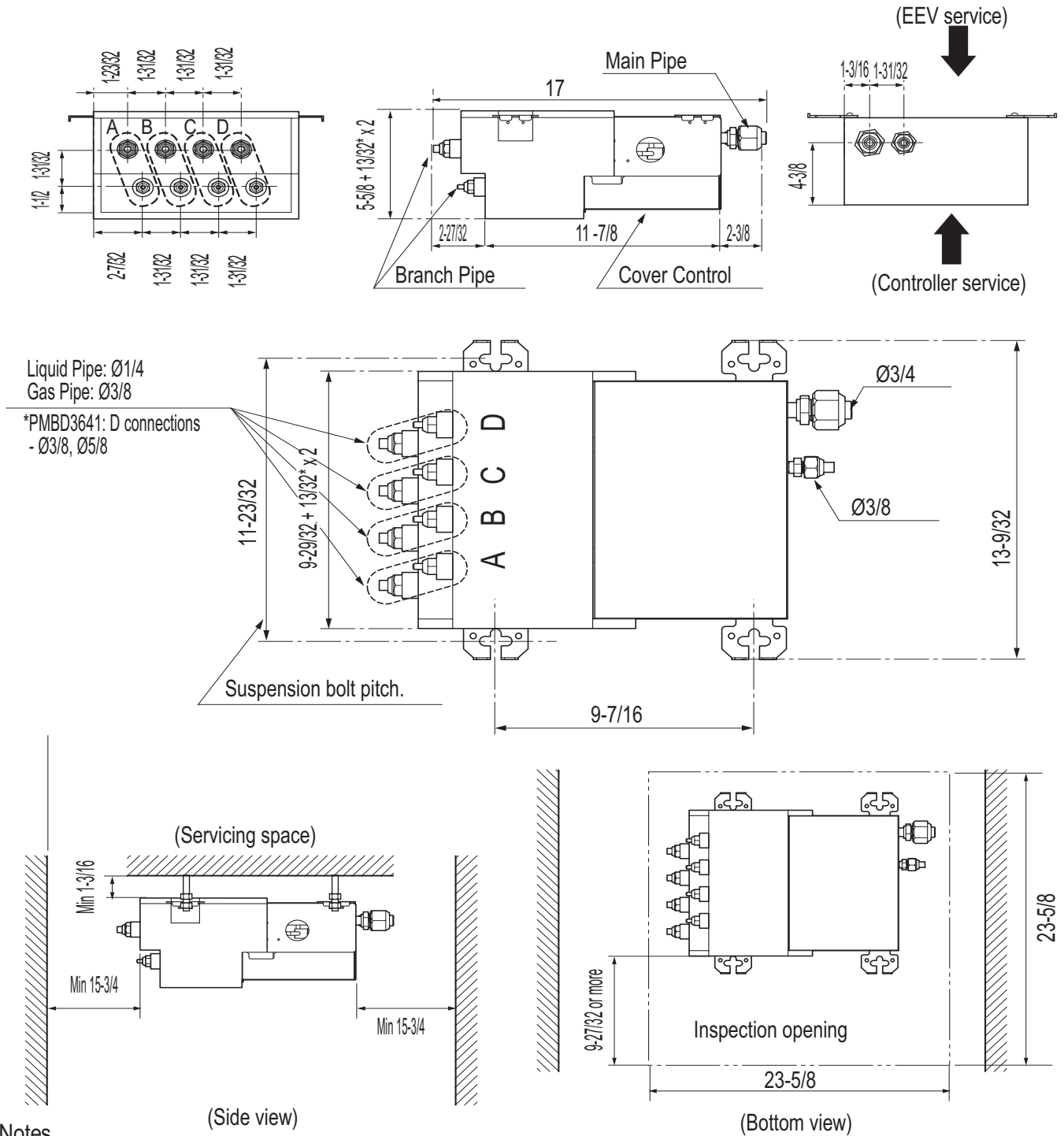

Branch Distribution (BD) Unit Data

Notes

1. PMBD3620 unit supplied with "A, B"
2. PMBD3630 unit supplied with "A, B, C"
3. PMBD3640, PMBD3641 unit supplied with "A, B, C, D"
4. \* Thickness of insulation

Unit: inch

# MULTI F MAX BD UNIT

## Refrigerant Flow Diagram

MULTI F  
MULTI F MAX

Figure 31: PMBD3620, PMBD3630, PMBD3640, PMBD3641 Refrigerant Flow Diagram.

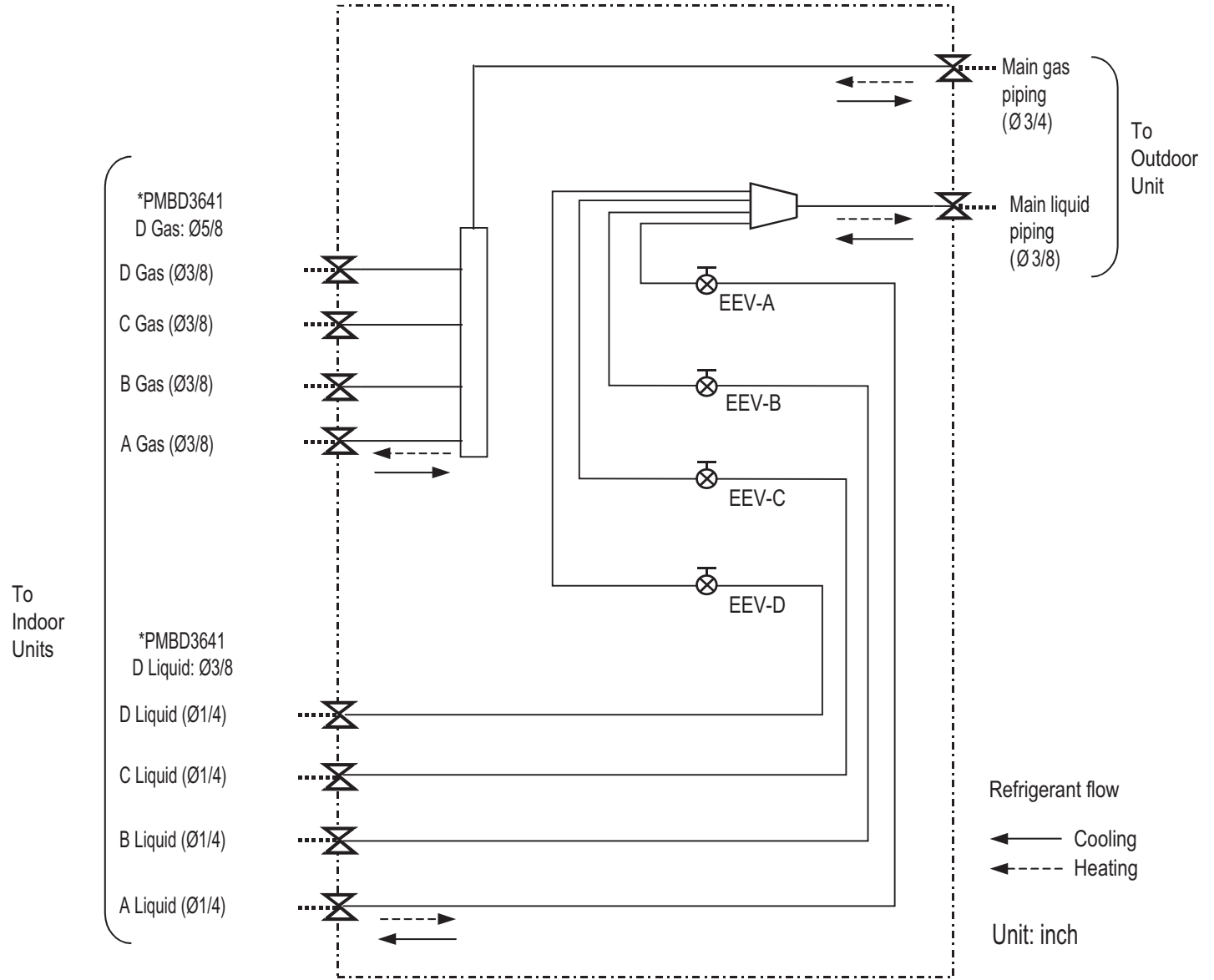

### Note:

1. Flare connections for field piping installation.
2. Match the BD ports to the indoor unit and outdoor unit piping sizes. Use an adapter if the piping size does not match the piping size of the connecting indoor unit.
3. EEV: Electronic Expansion Valve
4. PMBD3620 BD Unit supplied with "A, B".  
PMBD3630 BD Unit supplied with "A, B, C".  
PMBD3640 and PMBD3641 BD Units supplied with "A, B, C, D".

Figure 32: PMBD3620, PMBD3630, PMBD3640, PMBD3641 Wiring Diagram.

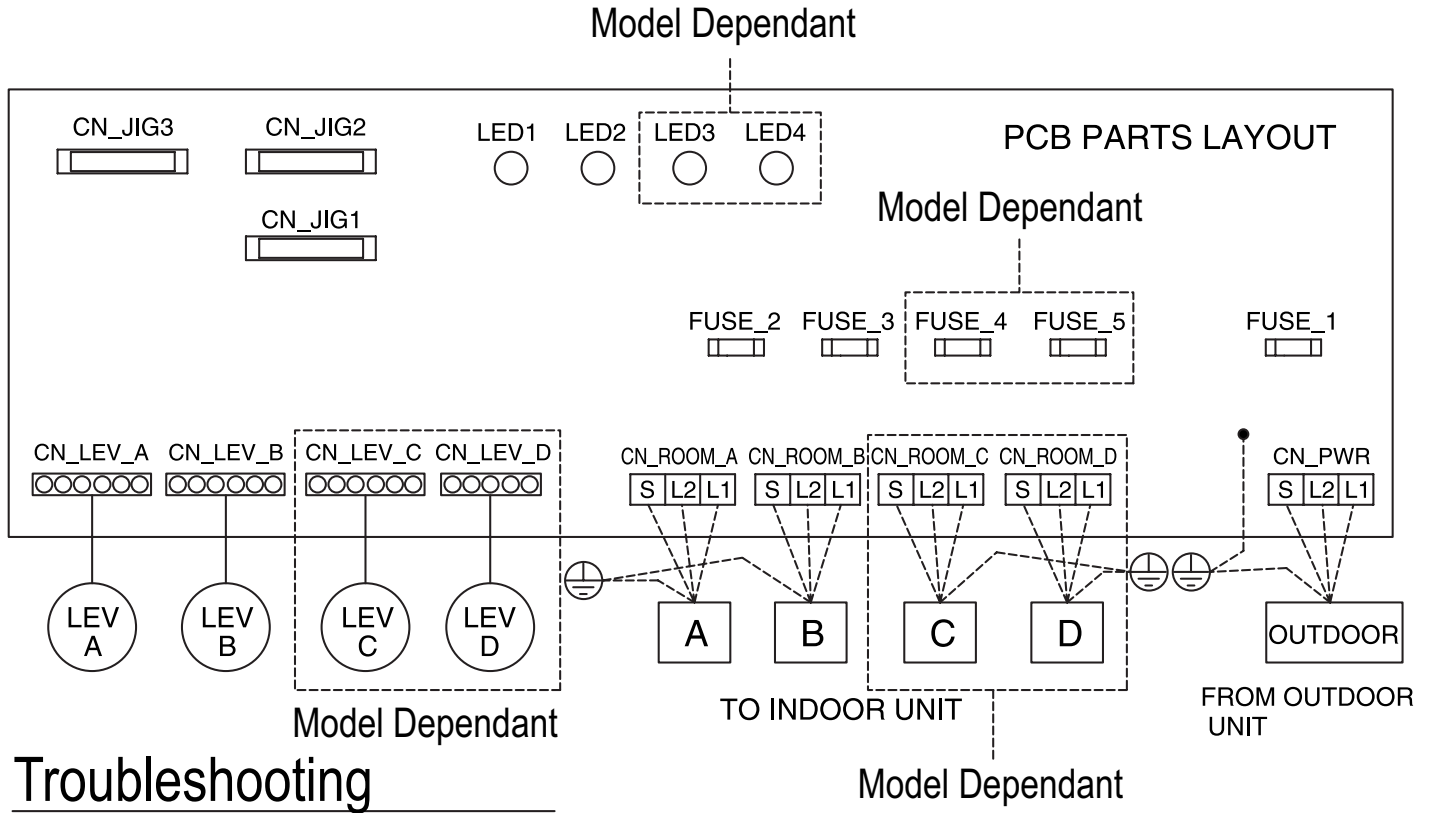

## Troubleshooting

LED	DIAGNOSIS
	NORMAL
	ABNORMALITY -->CHECK BRANCH DISTRIBUTOR UNIT
	ABNORMALITY -->CHECK INDOOR OR OUTDOOR UNIT CHECK CONNECTING CABLE

### Note:

PMBD3620 BD Unit supplied with "A, B".  
 PMBD3630 BD Unit supplied with "A, B, C".  
 PMBD3640 and PMBD3641 BD Units supplied with "A, B, C, D".

# MULTI F MAX BD UNIT

## Multi F MAX Y-Branch Accessory

MULTI F  
MULTI F MAX

Y-Branch accessory PMBL5620 is required when installing two branch distribution units in parallel on one Multi F MAX system.

Table 155: Multi F MAX Y-Branch Specifications.

Model	Y-Branch Type	Port Identifier (inch)		
		1	2	3
PMBL5620	Liquid	Ø3/8	Ø3/8	Ø3/8
	Vapor	Ø3/4	Ø3/4	Ø3/4
	Y-Branch Type	Dimensions (inch)		
		X	Y	
	Liquid	13.80	3.24	
Vapor	12.48	3.02		

Figure 33: Y-Branch Port Identifier Diagram.



Figure 34: Y-Branch Dimensions Diagram.

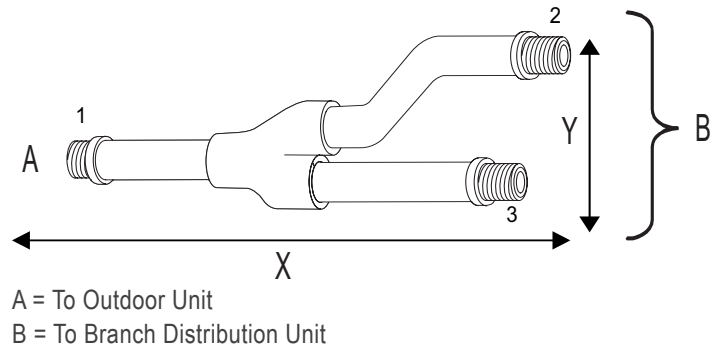

Multi F MAX Branch Distribution (BD) Units can be installed in a multitude of options to fit various building configurations and job or application requirements. Multi F MAX BD Units include electronic expansion valves that properly seat only if the BD Unit is installed in an acceptable orientation. Installations with improper BD Unit orientation risk incomplete valve seating and system performance degradation from potential refrigerant leakage through the electronic expansion valve.

**Note:**

*This material is for informational or educational purposes only. It is not intended to be a substitute for professional advice. Consult with your engineer or design professionals for specific applications to your system*

Figure 35: Acceptable BD Unit Ceiling Mount Orientations.

Ceiling Mounting Options

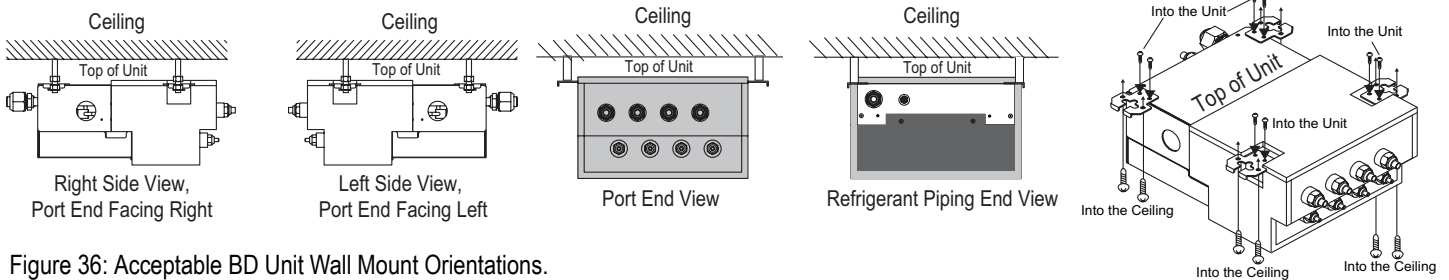

Figure 36: Acceptable BD Unit Wall Mount Orientations.

Wall Mounting Options

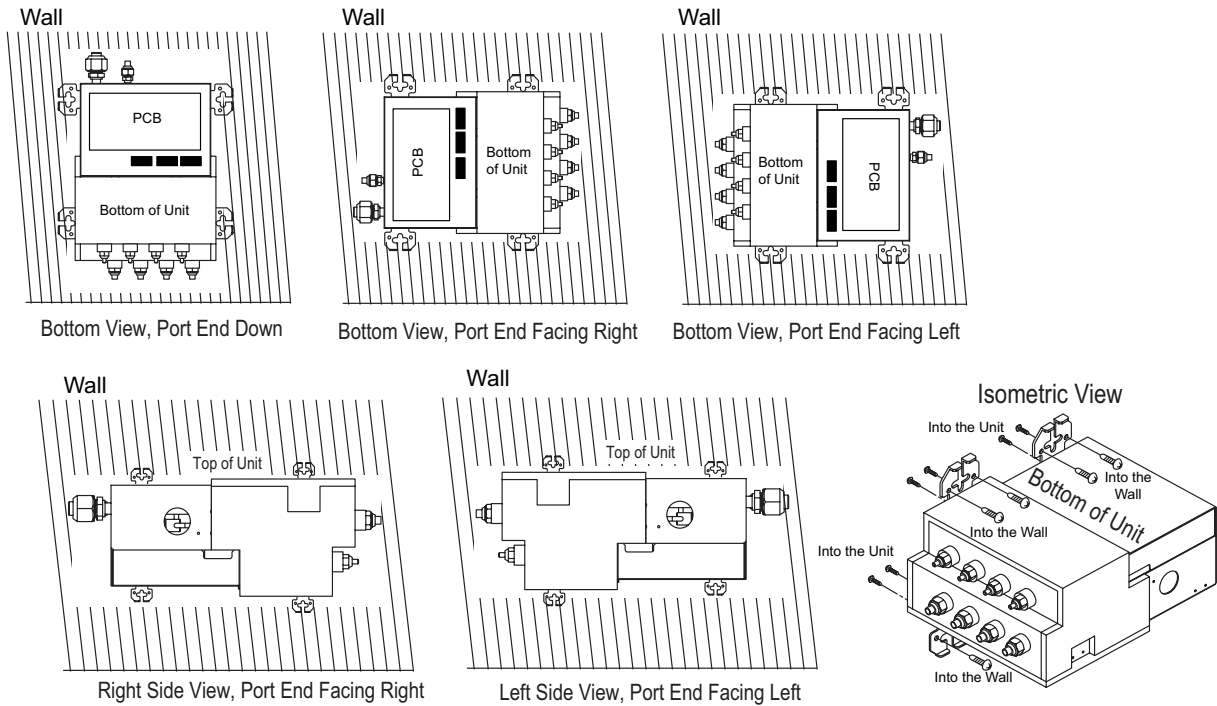
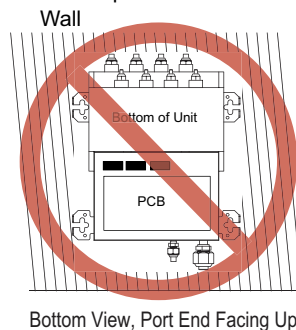

Figure 37: Unacceptable BD Unit Orientation.





# APPLICATION GUIDELINES

**“Equipment Selection Procedure” on page 180**

**“Building Ventilation Design Guide” on page 186**

**“Placement Considerations” on page 190**

To choose the multi-zone system that is the most appropriate for the space, as with traditional air-conditioning systems, follow similar protocols outlined in Manual J from the Air Conditioning Contractors of America (ACCA; see [www.acca.org](http://www.acca.org)).

1. Obtain the design conditions, and calculate the maximum cool and heat loads for the structure.
2. Select the equipment (choosing the appropriate indoor units and outdoor unit):
  - Determine number of zones.
  - Determine total number of indoor units (refer to zone load calculations when choosing indoor units).
  - Determine number of indoor units allocated to each outdoor unit, considering allowable indoor unit connections, both indoor unit and outdoor unit capacities, and system piping capabilities.
3. Determine the corrected capacity for the indoor units and outdoor unit using:
  - System Combination Tables.
  - Capacity Tables (it may be necessary to interpolate).
  - Capacity Coefficient Factors (such as refrigerant line length derates, design condition derates, defrost operation derate [heating mode], altitude derate [if applicable]).
4. Compare corrected capacities to load calculations.
5. Reselect equipment if necessary.

## Obtain Design Conditions, Calculate Maximum Cool / Heat Loads

Obtain the winter outdoor/indoor temperature and summer and winter outdoor/indoor temperature design parameters for the location in which the system is installed. Determine if summer or winter design gains, relative humidity, and building features like skylights, orientation, number of occupants, etc., would change the total heat loss / gain and sensible / latent heat gain, and then calculate the maximum cool and heat loads for the space (using Manual J, or energy modeling programs).

## Select the Equipment

### Determine the Number of Zones

Multi F heat pump systems can cool or heat, but not simultaneously. When designing larger-capacity Multi F heat pump systems or a Multi F MAX system, the designer may be able to combine spaces with similar load profiles located near or adjacent to each other into “thermal zones.” After combining like spaces into zones that will be served by a single (or grouped) indoor unit(s), calculate the peak cooling and heating loads for each zone.

### Choosing the Appropriate Indoor Units

Determine the appropriate indoor unit capacity that satisfies the given zone load calculations, choose how many (and which styles of) indoor units will be required. See Table 156 for allowable indoor unit to outdoor unit connections, and the maximum number of connectable indoor units on each Multi F and Multi F MAX outdoor unit. When choosing, also consider the cooling and heating CFM, featured airflow specifications, and static pressure (if applicable) for each indoor unit.

Avoid oversizing indoor units in an attempt to increase the air exchange rate in the space. Multi F and Multi F MAX systems are designed for minimum airflow over the coil to maximize latent capacity while cooling, maintain a comfortable, consistent discharge air temperature while heating, and minimize fan motor power consumption. In extreme cases, oversizing the indoor units may affect outdoor unit size selection and compromise the outdoor unit’s ability to effectively match the space load(s).

For proper system operation:

1. At least two indoor units must be connected to the outdoor unit.
2. Total connected indoor unit nominal capacity should be a minimum 40% and a maximum of 130% of outdoor unit nominal capacity.
3. To calculate the connected total indoor unit nominal capacity, simply sum up the nominal capacities of all indoor units. For 24,000 and 36,000 Btu/h indoor units, a 1.3 multiplier must first be applied before adding to the sum of other indoor units.

Table 156: Allowable Indoor Unit to Outdoor Unit Connections.

Indoor units		Outdoor units			
Model Type	Indoor Unit Nominal Capacity* (Btu/h)	LMU187HV	LMU247HV	LMU369HV	LMU540HV
	Btu/h	Maximum No. of Connectable Indoor Units			
ART COOL Mirror	9,000	0	0	0	0
	12,000	0	0	0	0
	18,000	-	0	0	0
ART COOL Gallery	9,000	0	0	0	0
	12,000	0	0	0	0
Wall Mounted	9,000	0	0	0	0
	12,000	0	0	0	0
	18,000	-	0	0	0
Ceiling Concealed Duct-Low Static	9,000	0	0	0	0
	12,000	0	0	0	0
	18,000	-	0	0	0
Ceiling Concealed Duct-High Static	24,000	-	-	0	0
	36,000	-	-	-	0
Four-Way Ceiling Cassette	12,000	0	0	0	0
	18,000	-	0	0	0
Vertical-Horizontal Air Handler	24,000	-	-	0	0
	36,000	-	-	-	0

**Choosing the Appropriate Outdoor Unit**

After all indoor units are properly sized to offset the applicable loads in each zone, select the outdoor unit by choosing a size that meets both the load-cooling requirement, and offsets the sum of the heating load. Then, the system's combination ratio should be evaluated and confirmed it is within the allowable range (the combination ratio compares the nominal capacity of all connected indoor units to the nominal capacity of the outdoor unit serving them). The total nominal capacity of all indoor units should be smaller than the total nominal capacity of the outdoor unit. If the combination ratio is more than 100%, the designer is undersizing the outdoor unit relative to the combined nominal capacity of the connected indoor units. In some designs, oversized indoor units may be unavoidable in the case where the smallest size indoor unit available from LG is larger than what is necessary to satisfy the zone load. This scenario may also occur when an indoor unit selection one size down from the selected unit is slightly short of fulfilling the design load requirements, and the designer must choose the next largest size unit. Sometimes it is recommended to choose a larger capacity outdoor unit if the installation space is big enough. Also, it may be prudent to oversize the outdoor unit to address those times when the weather conditions may exceed the design conditions, to minimize the possibility of ventilation systems that causes the space temperature to drift outside design parameters, or when the indoor unit's entering air temperature falls outside the approved design temperature range.

Table 157: Nominal Outdoor Unit Capacity.

		Outdoor Units			
		LMU187HV	LMU247HV	LMU369HV	LMU540HV
Nominal Capacity (Btu/h)	Cooling	15,600	19,200	34,000	52,500
	Heating	17,000	26,400	41,000	58,000
Connectable Indoor Units	Minimum No. of Connectable Indoor Units	2	2	2	2
	Maximum No. of Connectable Indoor Units	2	3	4	8
	Maximum Capacity Index	24,000	33,000	48,000	73,000

## Determine the Corrected Capacity

The *corrected* cooling / heating capacity is different from the nominal (rated) cooling / heating capacity. The corrected capacity includes changes in unit performance after considering design temperatures, available capacity that can be allocated from the outdoor unit, pressure drop due to refrigerant line length, defrost operation in heating mode, and (if applicable) altitude. Depending on the location of the building, additional capacity correction factors may need to be applied.

### Using the Outdoor Unit Cooling and Heating Capacity Tables

Nominal cooling capacity ratings are obtained with air entering the indoor unit at 80°F dry bulb (DB) and 67°F wet bulb (WB), and outdoor ambient conditions of 95°F dry bulb (DB) and 75°F wet bulb (WB). Nominal heating capacity ratings are obtained with air entering the indoor unit at 70°F dry bulb (DB) and 60°F wet bulb (WB) and outdoor ambient conditions of 47°F dry bulb (DB) and 43°F wet bulb (WB).

To evaluate the total outdoor unit capacity at design conditions, reference the Performance Data Capacity Tables found in the Multi F outdoor unit section in this manual. All design temperatures are not explicitly shown in the charts, therefore, interpolation may be necessary to calculate the capacity for specific design conditions. Based on the premise that capacity follows a linear curve, the following formula can be applied:

$$(y - y1) / (y2 - y1) = (x - x1) / (x2 - x1)$$

Where

- y = Missing Capacity (Capacity at the Design Temperature).<sup>1</sup>
- y1 = Capacity at Lower Temperature (Smaller value of the two nearest published TC datapoints).
- y2 = Capacity at Higher Temperature (Higher value of the two nearest published TC datapoints).
- x = Design Temperature (Temperature not shown in published capacity tables).<sup>2</sup>
- x1 = (Smaller value of the two nearest published temperature datapoints).
- x2 = (Larger value of the two nearest published temperature datapoints).

<sup>1</sup>Median between two published Total Capacity [TC] Btu/h datapoints in the capacity table.

<sup>2</sup>Median between two nearest published temperature datapoints.

### Using the Indoor Unit Cooling and Heating Capacity Tables

The datapoints shown in the indoor unit cooling and heating capacity charts are based on (and convey) an indoor unit operating with maximum possible refrigerant flow from the outdoor unit and before any derates are applied. In other words, the capacities displayed reflect what the indoor unit would produce if it was the only indoor unit that required capacity, and the outdoor unit did not have to allocate any capacity to another indoor unit.

System operation with a combination of indoor units is not conveyed in these charts, however, the information can be used to calculate indoor unit allocated capacity (without using the system combination tables). Simply calculate by using the formula:

$$Qidu(\text{combi}) = Qodu(\text{rated}) \times \frac{Qidu(\text{rated})}{\sum Qidu(\text{rated})}$$

Where

Qidu(combi) = Individual Indoor Unit Combination Capacity.

Qodu(rated) = Outdoor Unit Rated Capacity.

Qidu(rated) = Individual Indoor Unit Rated Capacity.

$\sum Qidu(\text{rated})$  = Total Connected Indoor Unit Rated Capacity.

### Note:

The formula can be used to find individual indoor unit capacity for Multi F MAX systems.

### Note:

A more accurate method to determine expected capacity would be to apply the outdoor unit's corrected capacity instead of rated capacity.

## Using the System Combination Tables

**Multi F system combination tables** illustrate how each indoor unit receives a percentage of total outdoor unit rated capacity. Allocation is based on:

- Combinations of Non-Ducted Indoor Units
- Combinations of Ducted Indoor Units
- Combinations of Mixed Non-Ducted and Ducted Indoor Units

**Multi F MAX system combination tables** only show the total connected indoor unit capacity, but individual indoor unit capacity can be calculated using the formula:

$$Q_{idu}(combi) = \frac{Q_{odu}(rated) \times Q_{idu}(rated)}{\sum Q_{idu}(rated)}$$

### Note:

A more accurate method to determine expected capacity would be to apply the outdoor unit's corrected capacity instead of rated capacity.

## Capacity Coefficient Factors

### Refrigerant Line Length Derates

For air-cooled systems, a capacity correction factor may have to be applied to account for the length of the system's refrigerant pipe. Rate of change in capacity due to increased piping lengths is shown in Tables 158 to 160.

Table 158: Multi F Outdoor Unit (Multiple Piping) to Indoor Unit Refrigerant Line Length Derates.

Piping Length (feet)	Cooling Capacity (%)	Heating Capacity (%)
<b>9,000 Btu/h Indoor Unit Models</b>		
25.0	100.0	100.0
32.8	98.0	99.0
49.2	94.8	97.4
65.6	91.6	95.8
82.0	88.4	94.2
<b>12,000 Btu/h Indoor Unit Models</b>		
25.0	100.0	100.0
32.8	97.6	98.6
49.2	93.8	96.4
65.6	89.9	94.1
82.0	86.1	91.9
<b>18,000 Btu/h Indoor Unit Models</b>		
25.0	100.0	100.0
32.8	98.6	99.6
49.2	96.4	99.0
65.6	94.1	98.3
82.0	91.9	97.7
<b>24,000 Btu/h Indoor Unit Models</b>		
25.0	100.0	100.0
32.8	98.2	99.2
49.2	95.4	98.0
65.6	92.4	96.6
82.0	89.6	95.4

Table 159: Multi F MAX Outdoor Unit to Branch Distribution Unit Refrigerant Line Length Derates.

Main Piping Length (feet)	16.4	32.8	49.2	65.6	82.0	98.4	114.8	131.2	147.6	164.0	180.4
Cooling Capacity (%)	100.0	98.8	97.3	95.8	94.3	92.8	91.3	89.8	88.3	86.8	85.3
Heating Capacity (%)	100.0	99.6	99.2	98.7	98.3	97.8	97.4	96.9	96.5	96.0	95.6

Figure 38: Multi F MAX Outdoor Unit to Branch Distribution Unit Refrigerant Line Length Derate Chart.

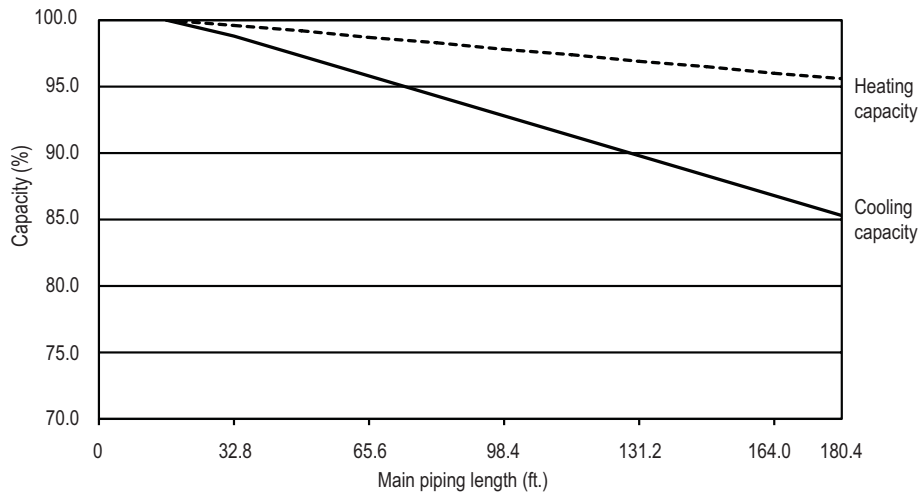

Table 160: Multi F MAX Branch Distribution Unit to Indoor Unit Refrigerant Line Length Derates.

Piping Length (feet)	Cooling Capacity (%)	Heating Capacity (%)
<b>9,000 Btu/h Indoor Unit Models</b>		
16.4	100.0	100.0
32.8	97.5	98.8
49.2	95.0	97.5
<b>12,000 Btu/h Indoor Unit Models</b>		
16.4	100.0	100.0
32.8	97.0	98.3
49.2	94.0	96.5
<b>18,000 Btu/h Indoor Unit Models</b>		
16.4	100.0	100.0
32.8	98.3	99.5
49.2	96.5	99.0
<b>24,000 Btu/h Indoor Unit Models</b>		
16.4	100.0	100.0
32.8	97.8	99.2
49.2	95.5	98.4
<b>36,000 Btu/h Indoor Unit Models</b>		
16.4	100.0	100.0
32.8	97.9	98.8
49.2	95.7	97.6

## Altitude Correction Factor

The impact of air density must be considered on systems installed at a significant altitude above sea level, therefore, locally accepted altitude correction factors must be applied.

## Defrost Correction Factor for Heating Operation

The outdoor unit heating capacity may need to be adjusted for frost accumulation on air-cooled systems. If design day conditions are below the dewpoint of the surrounding air, frost may not be a problem and no correction factor is needed. In certain weather conditions, however, frost may form and accumulate on the air-cooled outdoor unit coil and impact the coils ability to transfer heat. If significant frost accumulates on the outdoor unit coil, a defrost algorithm will start automatically. The timing between defrost periods is determined by the system's ability to achieve a target head pressure value.

Capacity and AHRI ratings tables do not factor in capacity reduction when frost has accumulated on the condenser coil, nor during defrost operation.

Integrated heating capacity values can be obtained using the formula:

$$A = B \times C$$

Where:

A = Integrated Heating Capacity.

B = Value found in the Capacity Table.

C = Correction Factor for Frost Accumulation Factor (from Table 161).

Table 161: Outdoor Unit Frost Accumulation Factor (Heating)<sup>1</sup>.

Entering DB (°F)	19.4	23.0	26.6	32.0	37.4	41.0	44.6
Derate factor	0.98	0.95	0.93	0.86	0.93	0.96	1.0

<sup>1</sup>At 85% outdoor air relative humidity.

The frost accumulation factor does not account for effects of snow accumulation restricting airflow through the outdoor unit coil.

## Note:

*There will be temporary reduction in capacity when frost / ice accumulates on the outside surface of the outdoor unit heat exchanger. The level of capacity reduction depends on a number of factors, for example, outdoor temperature (°F DB), relative humidity (RH), and the amount of frost present.*

## Check the Indoor and Outdoor Unit Selection(s)

Compare the corrected cooling and heating capacities to the load calculations. Is each capacity sufficient for the zone it serves?

For each indoor unit, the corrected capacity must be at least equal to the total of the cooling design load (plus ventilation load, if applicable) for the space(s) served by the indoor unit. For each indoor unit, the corrected capacity also must be at least equal to the total of the heating design load (plus ventilation load, if applicable) for the space(s) and / or thermal zones served by the indoor unit.

The outdoor unit selected should be large enough to offset the total cooling load for all spaces it serves (account for ventilation air cooling load if the ventilation air has not been pretreated to room neutral conditions). The outdoor unit should also be large enough to offset the total heating load for all spaces it serves.

If the corrected heating capacity ratio exceeds 100%, reselect the equipment, or change the system design by moving some of the load to another system.

## System Sizing Check Formulas

### 1. Outdoor Unit Rated Capacity.

$Q_{odu(rated)}$  (From capacity tables).

### 2. Outdoor Unit Capacity at $T_i$ , $T_o$ Temperature.

$Q_{odu(T_i, T_o)}$  (From capacity tables).

### 3. Outdoor Unit Capacity Coefficient Factor.

$$F_{(T_i, T_o)} = Q_{odu(T_i, T_o)} / Q_{odu(rated)}$$

### 4. Piping Correction Factor (From Capacity Coefficient Factor Tables).

$F_{(length)}$  for each piping length

### 5. Individual Indoor Unit Combination Capacity.

$$Q_{idu( combi)} = Q_{odu(rated)} \times Q_{idu(rated)} / Q_{idu(rated-total)}$$

### 6. Individual Indoor Unit Actual Capacity.

$$Q_{idu( actual)} = Q_{odu( combi)} \times F_{(T_i, T_o)} \times F_{(length, altitude)}$$

## Conclusions and Recommendations

- Understand the design safety factors.
- Reference load calculations for actual cooling and heating capacities (applies in 99% of applications – consider total load when latent load is greater than 30%).
- Verify that the sensible load of the zone is satisfied.

- Use caution when sizing to meet listed capacity specifications for the scheduled manufacturer's equipment.
- If further system design assistance is needed, or you have a unique application you would like to discuss, contact your LG sales rep.

ASHRAE Standards 62.1 and 62.2 (depending on if the building is residential or commercial), and local codes specify the minimum volume of airflow that must be provided to an occupied space. Outdoor air is required to minimize adverse health effects, and it provides acceptable indoor air quality for building occupants. Indoor units located within the zone typically require less airflow to condition the space. During the design phase, refer to the airflow capabilities listed in the specification tables for each product. Choose the best method for the application out of the five (5) ventilation options available.

## Note:

### Disclaimer

Although we believe that these building ventilation methods have been portrayed accurately, none of the methods have been tested, verified, or evaluated by LG Electronics, U.S.A., Inc., In all cases, the designer, installer, and contractor should understand if the suggested method is used, it is used at their own risk. LG Electronics U.S.A., Inc., takes no responsibility and offers no warranty, expressed or implied, of merchantability or fitness of purpose if this method fails to perform as stated or intended.

- For a complete copy of ASHRAE Standard 62.1 and 62.2, refer to the American Standard of Heating and Air Conditioning Engineers (ASHRAE) website at [www.ashrae.org](http://www.ashrae.org).

## Method 1: Natural Ventilation (Non-Ducted, Unconditioned Outdoor Air)

Natural ventilation devices, such as operable windows or louvers may be used to ventilate the building when local code permits.

### Advantages

- Occupants control the volume of the ventilation air manually.
- Useful for historic buildings that have no ceiling space available for outdoor air ductwork.
- May be used with the full lineup of Multi F indoor units.

### Disadvantages

- In some locations, it may be difficult to control humidity levels when windows are open.
- Thermal comfort levels may be substandard when windows are open.
- Indoor units may have to be oversized to account for the added heating and cooling loads when windows are open.
- Provides outdoor air to perimeter spaces only. Additional mechanical ventilation system may be required to satisfy requirements for interior spaces.
- Outdoor air loads may be difficult to calculate since the quantity of outdoor air is not regulated.
- May affect indoor unit proper operation when open.

Figure 39: Natural Ventilation (Non-Ducted, Unconditioned Outdoor Air).

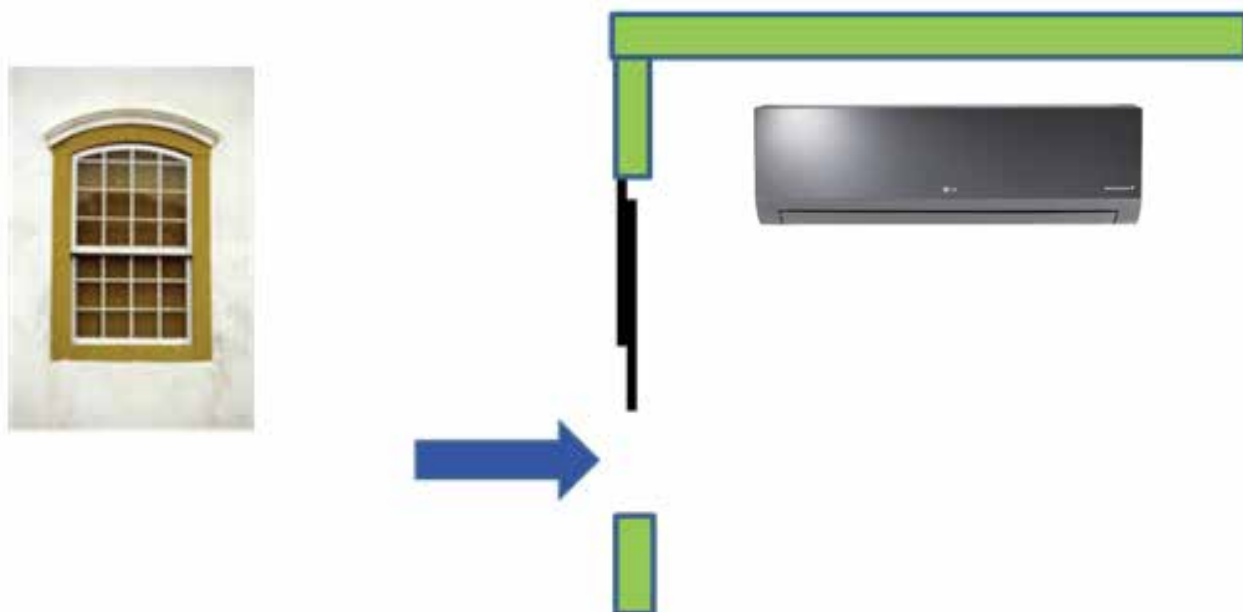

**Method 2: Unconditioned Outdoor Air (Non-Ducted, Fan Assisted Ventilation)**

When approved by local codes, the fan assisted ventilation method uses exhaust fans to remove air from the building, and outdoor air is drawn into occupied spaces through a wall louver or gravity roof intake hood. Supply fans can also be used to push the outdoor air into the space and building positive pressure will vent the exhaust air through louvers or roof-mounted exhaust hoods. Outdoor air is neither cooled nor heated before entering the building.

**Note:**

*This may result in loss of building pressurization control, increasing infiltration loads with adverse effects.*

**Advantages**

- Outdoor air may be manually controlled by the occupant or automatic controls may be installed to open/close outdoor air dampers or to turn on/off ventilation fans.
- Useful for large open spaces like warehouses, garages, and workshops.
- Outdoor air volume is a known quantity. Air loads may be easier to calculate since fans will regulate the amount of outdoor air.
- May be used with the full lineup of Multi F indoor units.

**Disadvantages**

- In some locations of the country, it may be difficult to control humidity levels.
- Indoor units may have to be oversized to account for the added heating/cooling loads when louvers/hoods are open.
- Hot, cold, and/or humid areas may be present if the outdoor air is not evenly distributed to the different spaces.

Figure 40: Unconditioned Outdoor Air (Non-Ducted, Fan Assisted Ventilation).

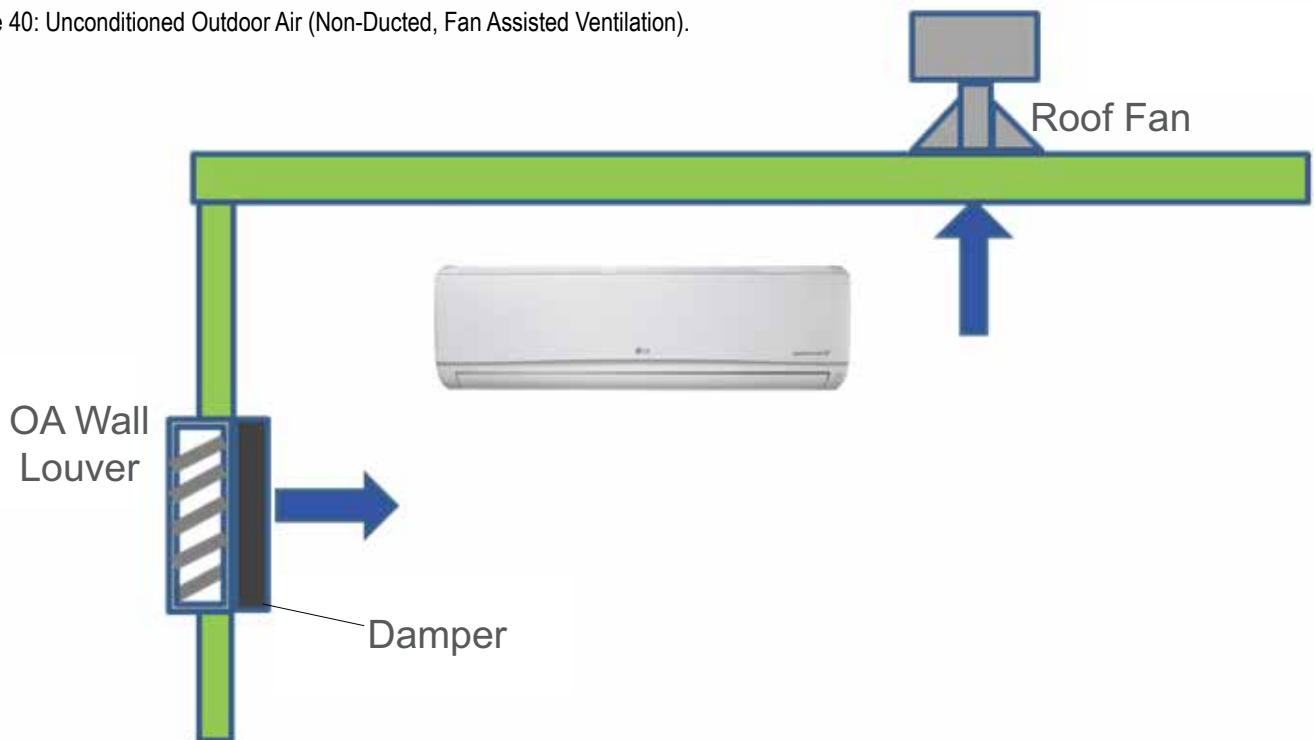

## Method 3: Unconditioned Outdoor Air Ducted to Indoor Units

Untreated outdoor air is channeled through a duct system that is piped to the return air duct on Multi F ducted indoor units or to the frame of Multi F four-way cassettes.

### Note:

Outside air may flow backward through the return air-filter grille when the indoor unit fan speed slows or stops in response to changes in the space load. This may result in captured particulate on the filter media being blown back into the conditioned space.

### Advantages

- May require less ductwork if indoor units are placed near outdoor walls or a roof deck.
- Controls must be interlocked to shut off the outdoor air supply fan when the space is unoccupied.
- Third-party demand-control ventilation controls may be installed to regulate outdoor intake based on the CO<sub>2</sub> levels of the occupied space.

### Disadvantages

- Fan(s) will be required to push outdoor air to the indoor unit to overcome the additional static pressure.
- Filter required to be added to the outdoor air duct.
- Ducted and four-way cassette models are the only indoor units that accept the connection of an outdoor air duct to the unit case.
- In most cases, in lieu of using the factory mounted return-air thermistor on indoor units, a remote wall temperature sensor or zone controller will be needed to provide an accurate reading of the conditioned area temperature.
- Unconditioned outdoor air may affect indoor unit performance, which may necessitate oversizing the indoor unit.

Figure 41: Unconditioned Outdoor Air Ducted to Indoor Units.

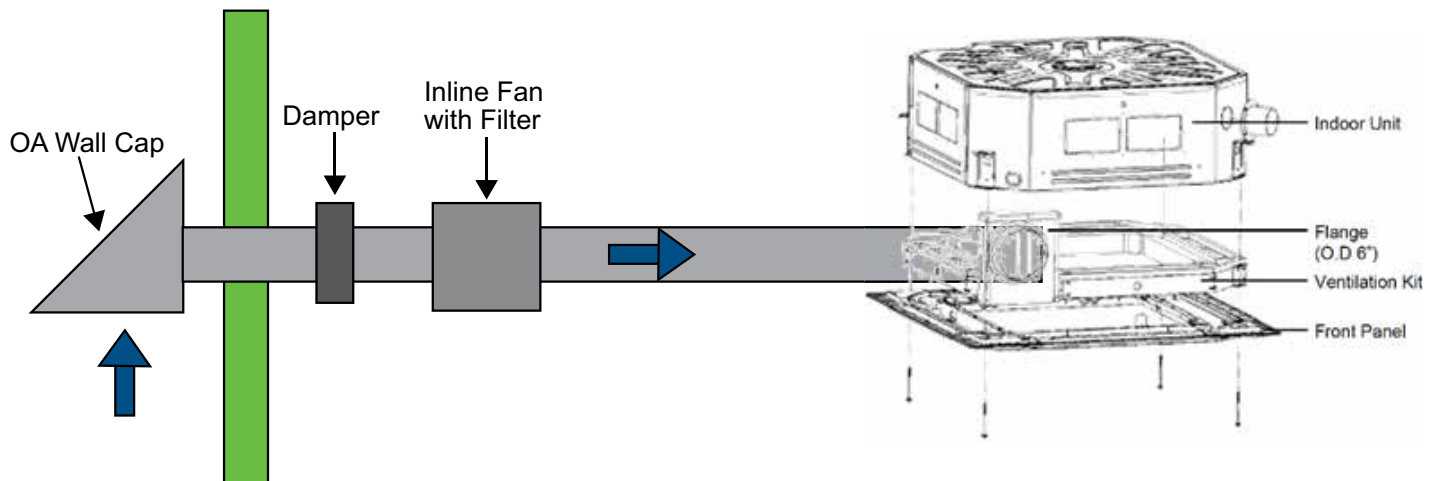

## Method 4: Coupled Dedicated Outdoor Air (CDOA)

A separate, dedicated outdoor air system delivers air directly to a Multi F indoor unit or to the return air duct system. After mixing with the return air stream, ventilation air passes through the indoor unit and into the conditioned space. The pretreatment system is capable of filtering, conditioning, and dehumidifying outdoor air to room neutral conditions.

### Note:

*Outside air may flow backward through the return air-filter grille when the indoor unit fan speed is reduced or stops when the space load is satisfied. This may result in captured particulate on the filter media being blown back into the conditioned space.*

### Advantages

- Indoor unit capacity may not need to be increased because of outdoor air.
- Fan and filter system is centralized to the main outdoor air unit.

### Disadvantages

- Ducted and four-way cassette indoor units are the only models designed for direct connection of an outside air duct.
- Ceiling space is required for ductwork.
- Failure of outdoor air may impact indoor unit operation.
- In lieu of using the factory mounted return-air thermistor, a remote wall temperature sensor or zone controller may be required to provide an accurate conditioned space temperature reading.

Figure 42: Coupled Dedicated Outdoor Air (CDOA).

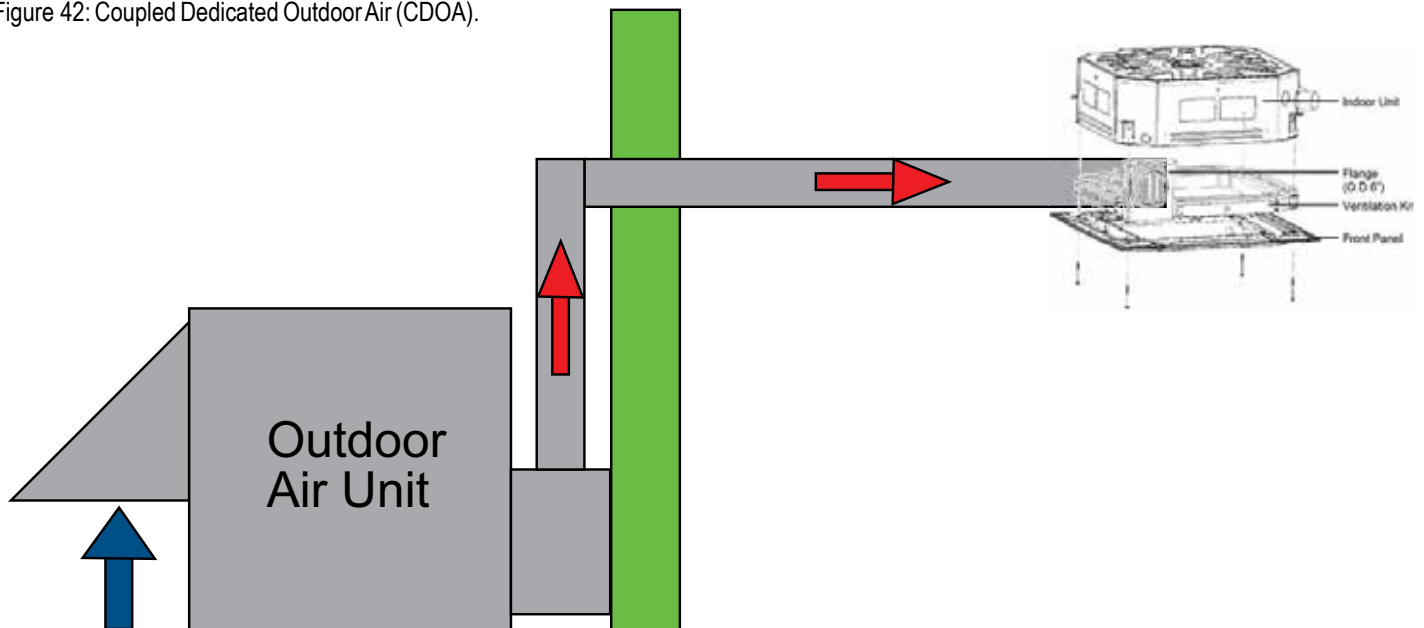

## Method 5: Decoupled Dedicated Outdoor Air System (DDOAS)

Provide a separate, dedicated outdoor-air system designed to filter, condition, and dehumidify ventilation air and deliver it directly to the conditioned space through a separate register or grille. This approach requires a separate independent ventilation duct system not associated with the Multi F system.

### Note:

LG recommends using the DDOAS method in all installations.

### Advantages

- Does not add additional heating or cooling loads to indoor units.
- May be used with the full lineup of Multi F indoor units.
- Failure of outdoor unit does not impact operation of indoor unit, the resulting untreated air will be readily noticed by the occupants.
- The outdoor air unit may supply “neutral” air to the occupant space even when the Multi F indoor unit fan changes speed or cycles on and off. DDOAS controls do not have to be interlocked with the Multi V F system.
- In lieu of installing localized smaller outside air treatment equipment throughout the building, this method centralizes the ventilation air source making service and filter changes easier and less disruptive for the building occupants.
- Third-party demand control ventilation controls are more readily accommodated.
- Indoor unit operation and performance will not be affected by the condition of outdoor air.

### Disadvantages

- Ceiling space is required to accommodate ductwork between the outdoor air unit and ceiling diffusers.

Figure 43: Decoupled Dedicated Outdoor Air System (DDOAS).

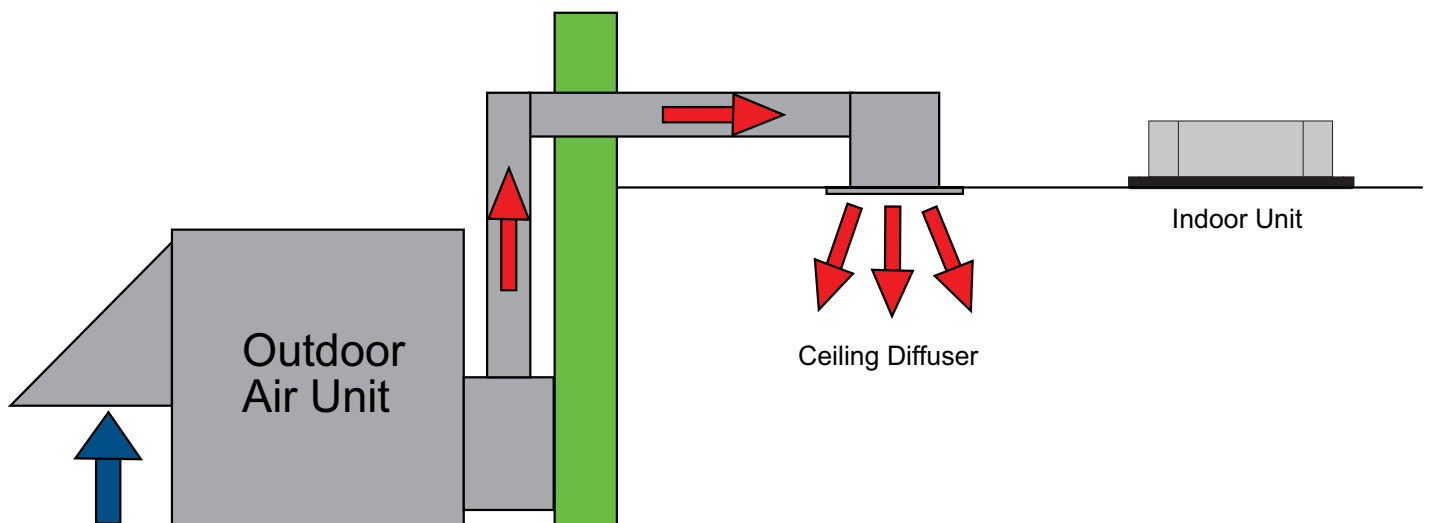

## Selecting the Best Location for the Indoor Units

Select a location for installing the indoor units that will meet the following conditions:

- Within allowable parameters for proper connection to the outdoor unit (or Branch Distribution unit, if a Multi F MAX system).
- No obstacles to air circulation around the unit; keep proper distances from ceilings, doorways, floor, walls, etc.
- So that condensation drainage can be conveniently routed away.
- Include enough space around the indoor unit so that it is accessible for maintenance and service purposes.
- Where electrical noise / electromagnetic waves will not affect indoor unit operation. Maintain proper distances between the indoor units and electric wires, audio and visual appliances, breaker / circuit panels, etc. If the frequency signal of the appliance is unstable, then install the indoor unit a minimum of ten (10) feet away, and run the power and transmission cables through a conduit.
- An area that is level and with enough strength to bear the weight of the indoor unit(s).
- An area where operation sound won't disturb occupants.
- An area that does not expose the indoor unit(s) to heat, water, steam, oil splattering or spray.

## Selecting the Best Location for the Branch Distribution (BD) Unit

BD units are used only with Multi F MAX systems to distribute the refrigerant from the outdoor unit to up to eight indoor units. Select location indoors that will meet the following conditions:

- Within allowable parameters for proper connection to the Multi F MAX outdoor unit and indoor unit(s); refrigerant piping and wire lengths must not exceed amounts specified by LG Electronics, U.S.A., Inc.
- No obstacles to air circulation around the unit; keep proper distances from ceilings, doorways, floor, walls, etc.
- Condensate drain piping is not required.
- Ensure there is enough space in the installation area for service purposes; install the refrigerant piping and electrical wiring system in an easily accessible location.
- Do not install the BD unit in a location where it would be subjected to strong radiation heat from heat sources.
- Avoid an installation environment where the BD unit would be exposed to heat, water, steam, oil splattering or spray.
- Where high-frequency electrical noise / electromagnetic waves will not affect operation. Maintain proper distances between the BD unit(s) and electric wires, audio and visual appliances, breaker / circuit panels, etc.
- Level where there is enough strength to bear the weight of the BD unit.
- Install the unit in a location where any sound it generates will not disturb occupants in the surrounding rooms.

## Selecting the Best Location for the Outdoor Unit

Select a location for installing the outdoor unit that will meet the following general conditions:

- A location strong enough to bear the weight of the outdoor unit.
- A location that allows for optimum air flow and is easily accessible for inspection, maintenance, and service.
- Where piping between the outdoor unit, indoor unit(s), and BD units (Multi F MAX systems only) are within allowable limits.
- Where it will not be subjected to direct thermal radiation from other heat sources, nor an area that would not expose the outdoor unit to heat or steam like discharge from boiler stacks, chimneys, steam relief ports, other air conditioning units, kitchen vents, plumbing vents, and other sources of extreme temperatures.
- Where operating sound from the unit will not disturb inhabitants of surrounding buildings.
- Where the unit will not be exposed to direct, strong winds.
- Where high-frequency electrical noise / electromagnetic waves will not affect operation.
- Include space for drainage to ensure condensate flows properly out of the unit when it is in heating mode. Avoid placing the outdoor unit in a low-lying area where water could accumulate.

### Note:

*When deciding on a location to place the outdoor unit, be sure to choose an area where run-off from defrost mode will not accumulate and freeze on sidewalks or driveways.*

- To avoid the possibility of fire, do not install the unit in an area where combustible gas may generate, flow, stagnate, or leak.
- Don't install the unit in a location where oil, acidic solutions, sprays, or dust (sulfur, carbon, other corrosive materials) are present / often used.

## Rooftop Installations

If the outdoor unit is installed on a roof structure, be sure to level the unit. Ensure the roof structure and anchoring method are adequate for the unit location. Consult local codes regarding rooftop mounting.

## Oceanside Installation Precautions

- Avoid installing the outdoor unit where it would be directly exposed to ocean winds.
- Install the outdoor unit on the side of the building opposite from direct ocean winds.
- Select a location with good drainage.
- Periodically clean dust or salt particles off of the heat exchanger with water.

### Note:

*Additional anti-corrosion treatment may need to be applied to the outdoor unit at oceanside locations.*

### Note:

*Ocean winds may cause corrosion, particularly on the condenser and evaporator fins, which, in turn could cause product malfunction or inefficient performance.*

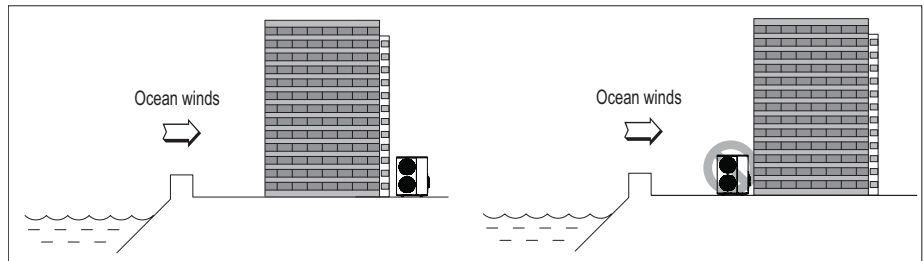

If the outdoor unit must be placed in a location where it would be subjected to direct ocean winds, install a concrete windbreaker strong enough to block any winds. Windbreaker height and width should be more than 150% of the outdoor unit, and be installed at least 27-1/2 inches away from the outdoor unit to allow for airflow.

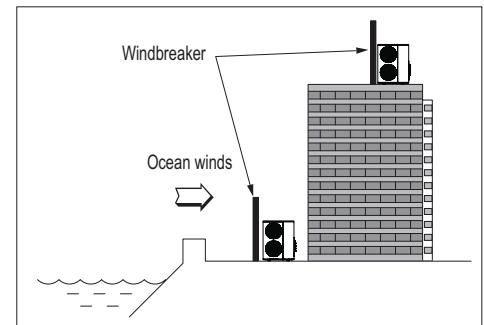

## Planning for Snow and Ice

In climates that experience snow buildup, place the unit on a suitably high platform to ensure proper condenser airflow. The raised support platform must be high enough to allow the unit to remain above possible snow drifts. Mount the unit on a field-provided snow stand at a minimum height that is equal to the average annual snowfall, plus 20 inches. Design the mounting base to prevent snow accumulation on the platform in front or back of the unit case. If necessary, provide a field fabricated hood to keep snow and ice and/or drifting snow from accumulating on the coil surfaces. Use inlet and discharge duct or hoods to prevent snow or rain from accumulating on the fan inlet and outlet guards. Best practice prevents snow from accumulating on top of the unit. Consider tie-down requirements in case of high winds or where required by local codes.

## Outdoor Unit Platform Requirements

Figure 44: Outdoor Unit Foundation Requirements.

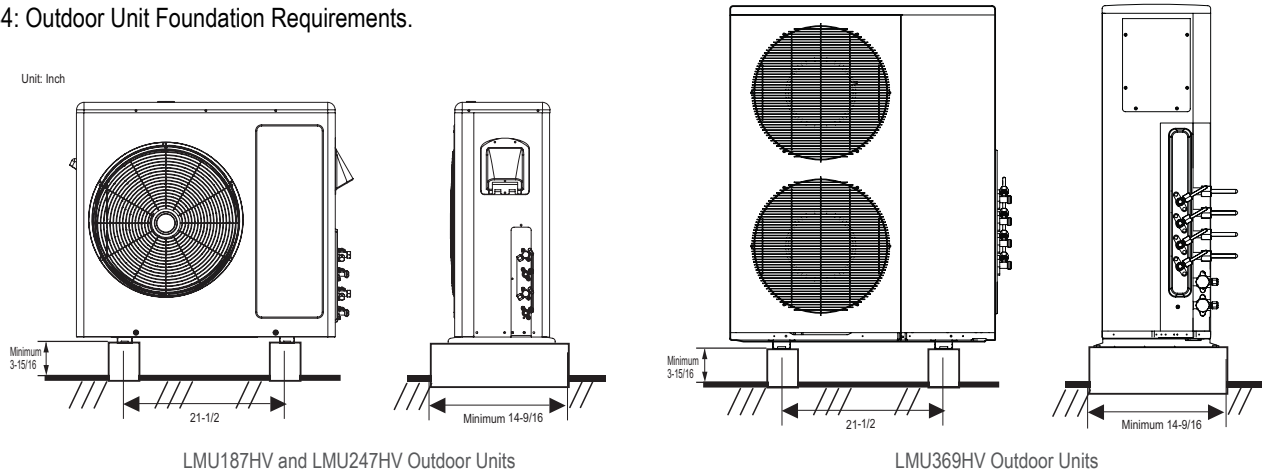
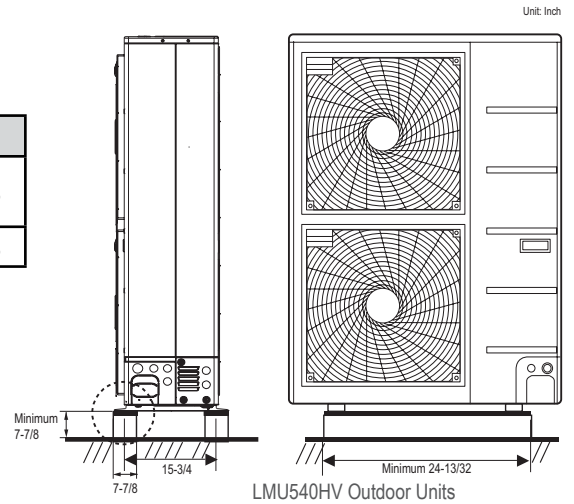

Table 162: Outdoor Unit Foundation Specifications.

Outdoor Unit Type	Bolt Type	Concrete Height	Bolt Depth
LMU187HV, LMU247HV, LMU369HV	M10-J	Minimum 3-15/16 inches	Minimum 2-3/4 inches
LMU540HV	M10-J	Minimum 7-7/8 inches	Minimum 2-3/4 inches



### Bolting the Outdoor Unit to the Platform

1. Ensure that the concrete platform will not degrade easily, and has enough strength to bear the weight of the unit.
2. Include an H-beam support. Firmly attach the corners, otherwise the support will bend.
3. Use a hexagon nut.
4. Use anti-vibration material.
5. Include enough space around the concrete foundation for condensate drainage.
6. Seal all wiring and piping access holes to prevent bugs from entering the unit.

### Concrete Platform Specifications

- Concrete foundations should be made of one part cement, two parts sand, and four parts gravel.
- The surface of the foundation should be finished with mortar with rounded edges, and weatherproofed.

Figure 45: Bolting the Outdoor Unit to the Platform.

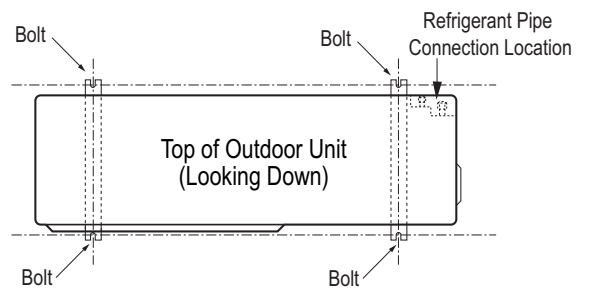
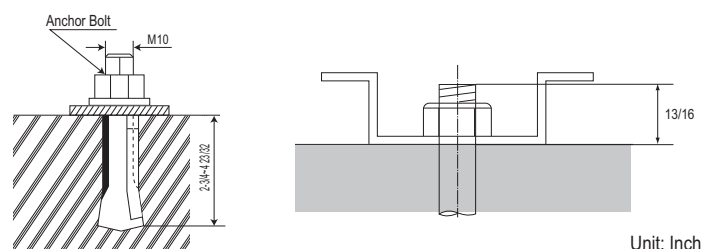

Figure 46: Close up of Bolt Attachment.



Unit: Inch

## Tie-Downs and Lightning Protection

### Tie-Downs

- The strength of the roof must be checked before installing the outdoor units.
- If the installation site is prone to high winds or earthquakes, when installing on the wall or roof, securely anchor the mounting base using a field-provided tie-down configuration approved by a local professional engineer.
- The overall tie-down configuration must be approved by a local professional engineer. Always refer to local code when using a wind restraint system.

### Lightening Protection

- To protect the outdoor unit from lightning, it should be placed within the specified lightning safety zone.

Table 163: Safety Zone Specifications.

Building Height (feet)	66	98	148	197
Protection Angle (°)	55	45	35	25

- Power cable and communication cable should be installed five (5) feet away from lightning rod.
- A high-resistance ground system should be included to protect against induced lightning or indirect strike.

Figure 47: Lightning Protection Diagram.

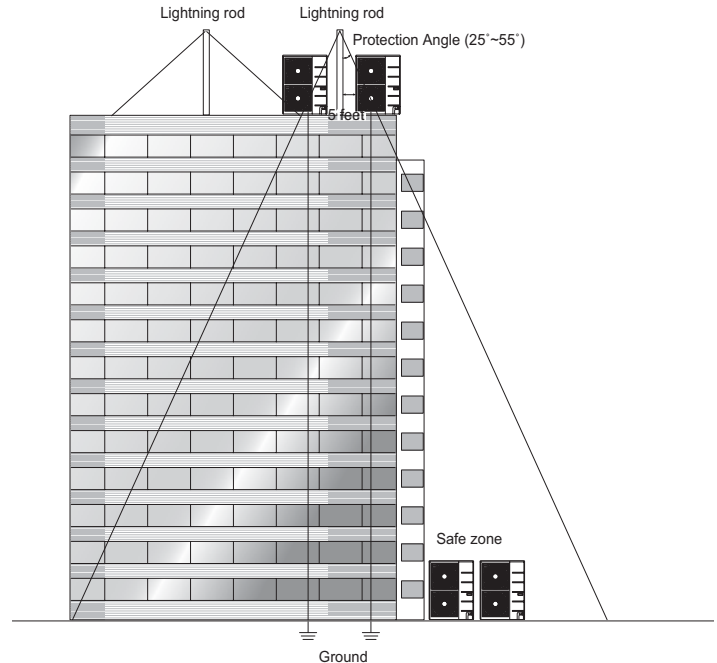

### Note:

*If the building does not include lightning protection, the outdoor unit may be damaged from a lightning strike. Inform the customer of this possibility in advance.*

## Outdoor Unit Service Access and Allowable Clearances

Appropriate airflow through the outdoor unit coil is critical for proper unit operation.

- Include enough space for airflow and for service access. If installing multiple outdoor units, avoid placing the units where the discharge of one unit will blow into the inlet side of an adjacent unit.
- No obstacles to air circulation around the unit; keep proper distances from ceilings, fences, floor, walls, etc. (Install a fence to prevent pests from damaging the unit or unauthorized individuals from accessing it.)
- If an awning is built over the unit to prevent direct sunlight or rain exposure, make sure that the discharge air of the outdoor unit isn't restricted.

When installing the outdoor unit, consider service, inlet, and outlet, and minimum allowable space requirements as illustrated in the following diagrams.

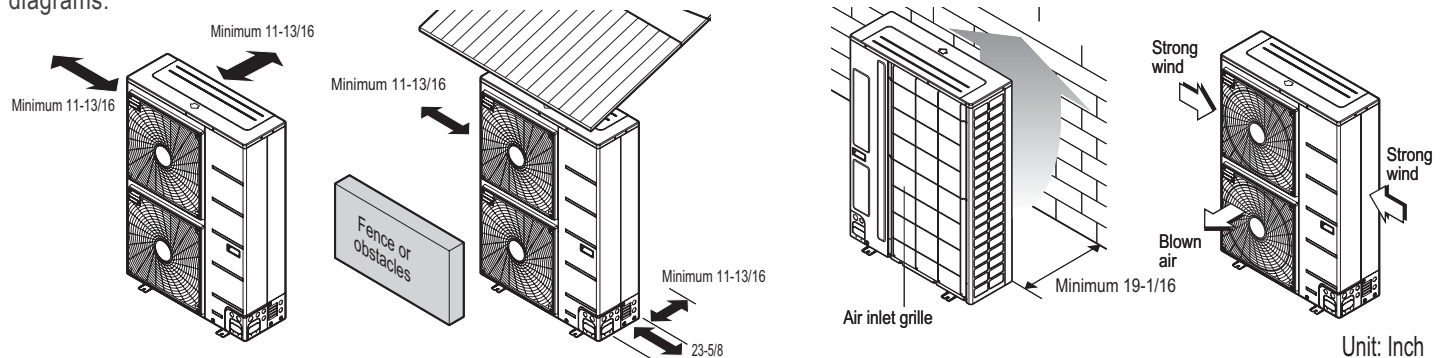

Ensure that the space at the back of the outdoor unit is a minimum of 11-13/16 inches, and include a minimum of 23-5/8 inches at the right side of the unit for service.

If the outdoor unit discharge side faces a wall, include a minimum of 19-11/16 inches between the outdoor unit and the wall. Install the outdoor unit so that the discharge port is set at a right angle to the wind direction.

Clearance Requirements when Different Obstacles are Present (Unit: Inch).

Obstacle on the suction side only.

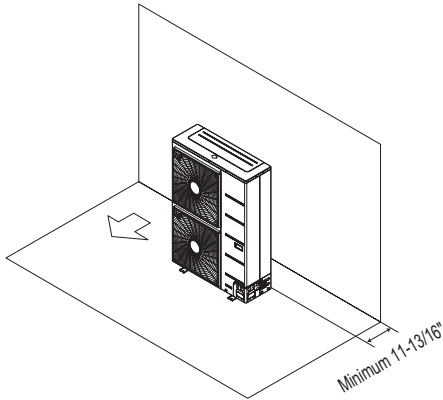

Obstacles on the suction side and on both left and right sides.

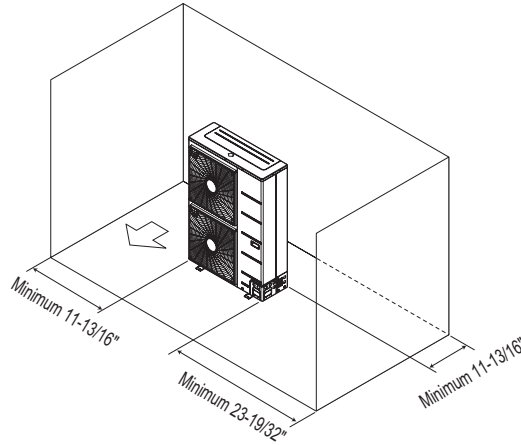

Obstacles above and on the air intake side.

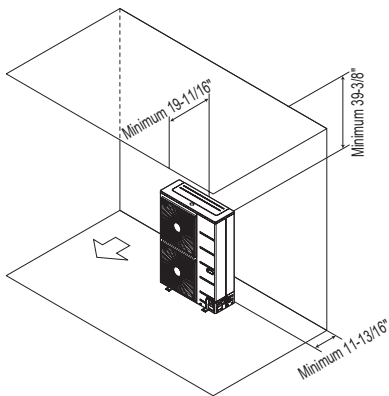

Obstacles above, on the air intake side, and on both left and right sides

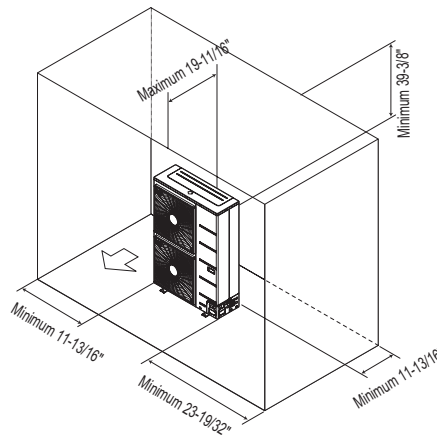

Obstacle just on the air discharge side.

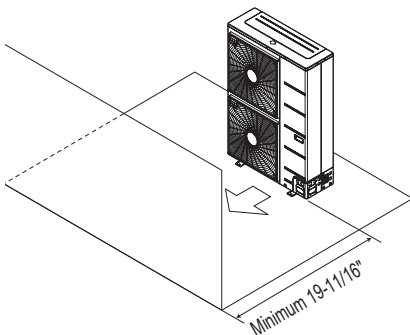

Obstacles above and on the air discharge side.

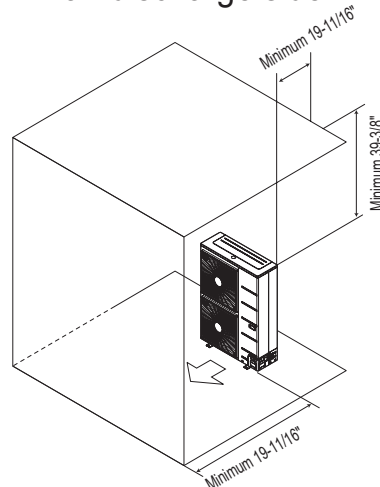

# PLACEMENT CONSIDERATIONS

MULTI F  
MULTI F MAX

## Clearance Requirements when Different Obstacles are Present, continued. (Unit: Inch)

Where there are obstacles on both suction and discharge sides (discharge side obstacle is higher than the outdoor unit).

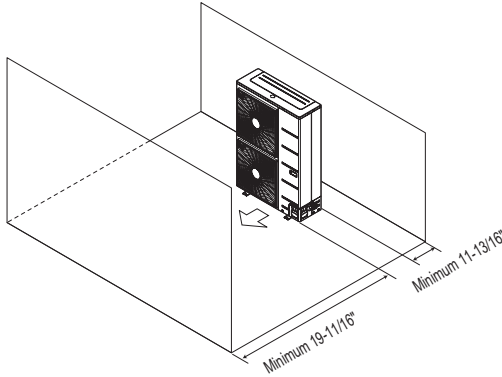

Where there are obstacles above, and on both suction and discharge sides (discharge side obstacle is higher than the outdoor unit).

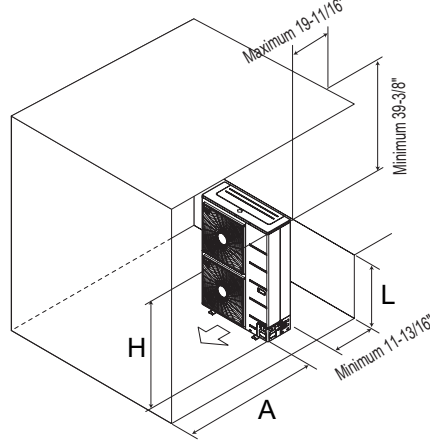
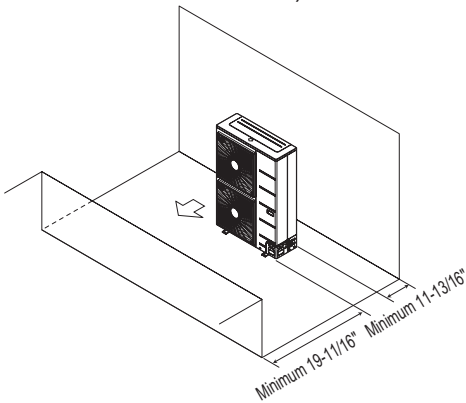

Table 164: Ratio among H, A, and L.

	L	A
L ≤ H	0 < L ≤ 1/2 H	29-1/32 inches
	1/2 H < L	39-3/8 inches
H < L	Set Stand as: L ≤ H	

If a stand is necessary, it should be contained (not open frame) to prevent the discharge air from short cycling.

Where there are obstacles on both suction and discharge sides (discharge side obstacle is lower than the outdoor unit).



Where there are obstacles above, and on both suction and discharge sides (discharge side obstacle is lower than the outdoor unit).

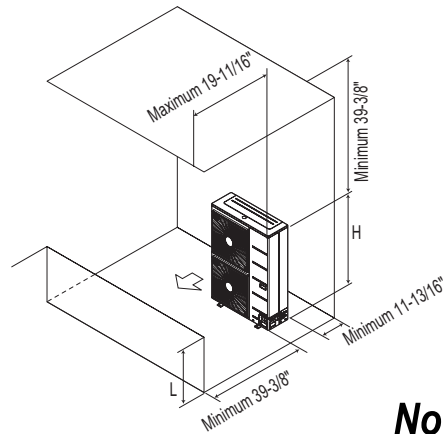

### Series installation

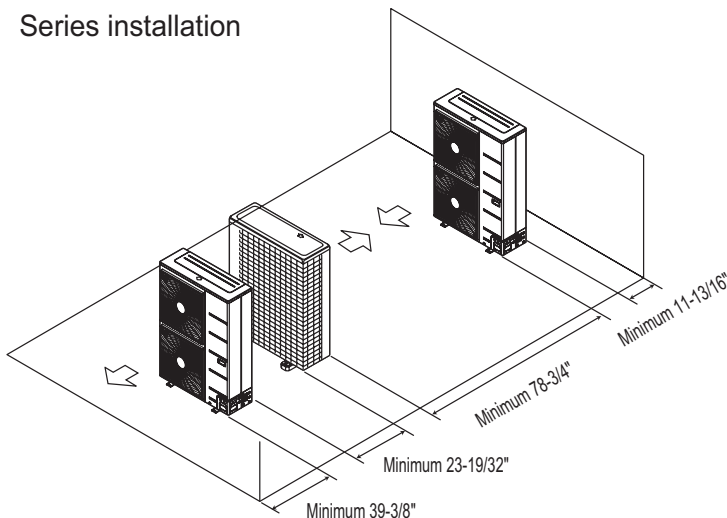

### Note:

"L" should be lower than "H". If a stand is necessary, it should be contained (not open frame) to prevent the discharge air from short cycling.

# REFRIGERANT PIPING DESIGN & LAYOUT BEST PRACTICES

**“Design Guideline Summary” on page 198**

**“Creating a Balanced / Quality Piping System” on page 200**

**“Manual Layout Procedure” on page 200**

**“LG Engineered Multi F MAX Y-Branch Kits” on page 201**

**“Refrigerant Charge” on page 202**

**“Selecting Field-Supplied Copper Tubing” on page 204**

**“Refrigerant Piping System Layout” on page 206**

**“Piping Insulation” on page 214**

**“Condensate Drain Piping” on page 215**

**“Cut Sheet” on page 217**

# REFRIGERANT PIPING DESIGN

MULTI F  
MULTI F MAX

## Design Guideline Summary

The following are examples of manual pipe size calculations. Designers are highly encouraged to use LATS for Multi F systems.

### Device Connection Limitations

- The minimum number of connected and operating indoor units to Multi F / Multi F MAX systems is two, taking into consideration of the minimum combination ratio.
- The maximum number of indoor units for each Multi F / Multi F MAX heat pump systems is:

LMU187HV = 2      LMU247HV = 3      LMU369HV = 4      LMU540HV = 8

One of the most critical elements of multi-zone systems is the refrigerant piping. The following pages list pipe length limits that must be followed in the design of Multi F and Multi F MAX refrigerant pipe systems:

### Using Refrigerant Components

Field-supplied elbows are allowed as long as they are designed for use with R410A refrigerant. The designer, however, should be cautious with the quantity and size of fittings used, and must account for the additional pressure losses in equivalent pipe length calculation for each branch. The equivalent pipe length of each elbow must be added to each pipe segment.

Table 165: Equivalent Piping Length for Elbows, Y-branches, and Branch Distribution Units.

Component	Size (Inches)				
	1/4	3/8	1/2	5/8	3/4
Elbow (ft.)	0.5	0.6	0.7	0.8	1.2
Y-Branch Kit (ft., Multi F MAX systems only) <sup>1</sup>	1.6				
Branch Distribution Unit (ft., Multi F MAX systems only)	8.2				

<sup>1</sup>Kit contains two Y-branches: one for liquid and one for vapor.

### Multi F System

Example: LMU369HV outdoor unit with four (4) indoor units connected.

ODU: Outdoor Unit.

IDU: Indoor Unit.

A, B, C, D: Pipes from Outdoor Unit to Indoor Unit.

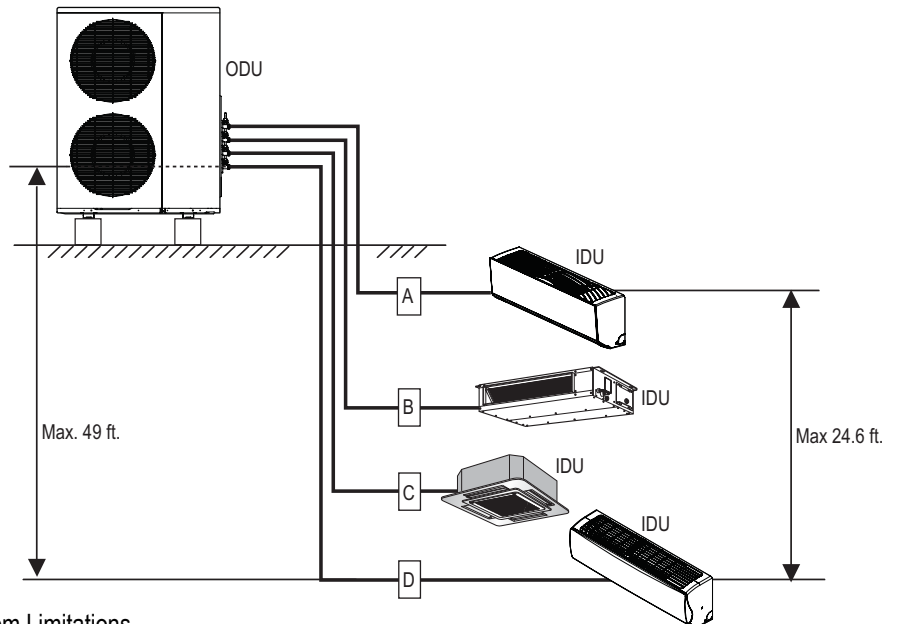

Table 166: Multi F Outdoor Unit Refrigerant Piping System Limitations.

Outdoor Unit	Minimum Length for Each Pipe (ft.)	Maximum Piping Length to Each Indoor Unit (ft.)				Maximum Total Piping Length for Each System (ft.)
		A	B	C	D	
LMU187HV	10	82	82	-	-	164
LMU247HV	10	82	82	82	-	246
LMU369HV	10	82	82	82	82	246

The following are examples of manual pipe size calculations. Designers are highly encouraged to use LATS for Multi F systems.

### Multi F MAX System with One Branch Distribution Unit

Example: LMU540HV outdoor unit with four (4) indoor units, and one (1) branch distribution unit connected.

ODU: Outdoor Unit.

IDU: Indoor Unit.

BDU: Branch Distribution Unit.

A: Main Pipe.

B: Branch Pipe (Branch Distribution Unit to Indoor Unit[s]).

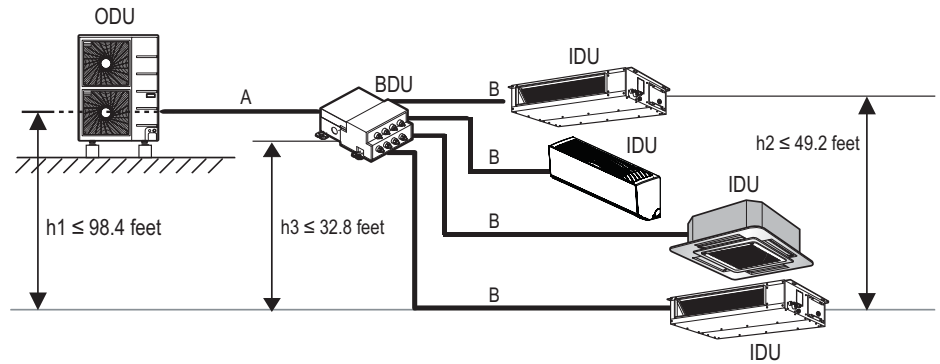

### Multi F MAX System with Two Branch Distribution Units

Example: LMU540HV outdoor unit with seven (7) indoor units, and two (2) branch distribution units connected.

ODU: Outdoor Unit.

IDU: Indoor Unit.

BD: Branch Distribution Unit(s).

$\Sigma A$ : Main Pipe.

$\Sigma B$ : Branch Pipe (Branch Distribution Unit[s] to Indoor Unit[s]).

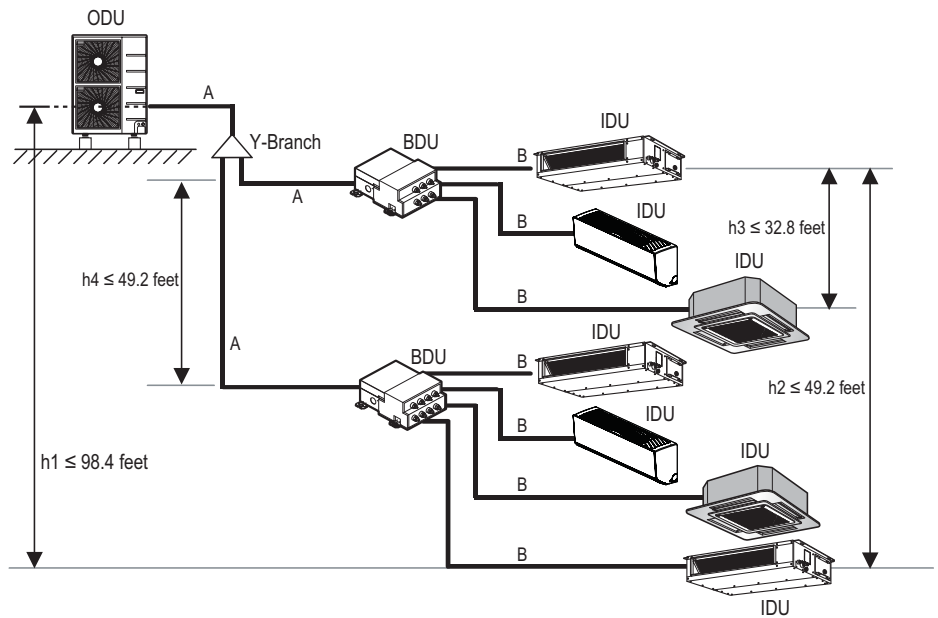

Table 167: Multi F MAX Outdoor Unit Refrigerant Piping System Limitations.

Pipe Length (ELF = Equivalent Length of pipe in Feet)	Total piping length ( $\Sigma A + \Sigma B$ )		≤475.7 feet
	Main pipe (Outdoor Unit to Branch Distribution Units: $\Sigma A$ )	Minimum	10 feet
		Maximum	≤180.4 feet
	Total branch piping length ( $\Sigma B$ )		≤295.3 feet
Branch pipe (Branch Distribution Units to Indoor Units: B)	Minimum	10 feet	
	Maximum	≤49.2 feet	
Elevation Differential (All Elevation Limitations are Measured in Actual Feet)	If outdoor unit is above or below indoor unit (h1)		≤98.4 feet
	Between the farthest two indoor units (h2)		≤42.9 feet
	Between branch distribution unit and farthest indoor unit(s) (h3)		≤32.8 feet
	Between branch distribution units (h4)		≤42.9 feet

Table 168: Multi F MAX Piping Sizes.

Piping	Main Pipe A (inch)	Branch Pipe B
Liquid	Ø3/8	Depends on the size of the indoor unit piping
Gas	Ø3/4	

### Creating a Balanced / Quality Piping System

Unlike designing duct-work or chilled and hot water pipe systems where balancing dampers, ball valves, orifices, circuit setters, or other flow control devices can be installed to modify or balance the flow of cooling medium, these cannot be used in a Multi F system. Therefore, variable refrigerant flow systems have to be designed to be “self balanced.” Balanced liquid refrigerant distribution is solely dependent on the designer using the correct pipe size for each segment. Pipe sizing considerations include pipe length, pipe segment pressure drop relative to other pipe segments in the system, type and quantity of elbows, bends present, fitting installation orientation, and end use device elevation differences.

#### Note:

*The designer should avoid creating excessive pressure drop. When liquid refrigerant is subjected to excessive pressure drop, liquid refrigerant will change state and “flash” to vapor. Vapor present in a stream of liquid refrigerant before reaching the indoor unit coil (or branch distribution unit for Multi F MAX systems) results in a loss of system control and causes damage to the components. The pipe system must be designed in a manner that avoids the creation of unwanted vapor.*

### Refrigerant Piping System Verification

To ensure that the refrigerant piping design is suitable for the system, a LATS refrigerant piping design software report must be provided with every Multi F order. Following the installation, if any changes or variations to the design were necessary, an “as-built” LATS piping design software report must be provided to LG prior to system commissioning. User should always check the LATS report actual pipe layout versus pipe limits.

#### Note:

*Any field changes, such as re-routing, shortening or lengthening a pipe segment, adding or eliminating elbows and/or fittings, re-sizing, adding, or eliminating indoor units, changing the mounting height or moving the location of a device or fitting during installation should be done with caution and ALWAYS VERIFIED in LATS MULTI SOFTWARE before supplies are purchased or installed. Doing so ensures profitable installation, eliminates rework, and ensures easier system commissioning.*

### Manual Layout Procedure

1. Choose the location of the indoor units on the building drawing.
2. Choose the location of all Y-branch and branch distribution units (if a Multi F MAX system) and note them on the building drawing. Verify that all fittings are positioned per the guideline limitations set forth in “Y-branch Kits” on page 201.
3. Plan the route for interconnecting piping. Draw a one-line depiction of the pipe route chosen on the building drawing.
4. Calculate the actual length of each pipe segment and note it on the building drawing.
5. Using the data obtained while selecting the system components on page 180 to 185, list the corrected cooling capacity next to each indoor unit on the drawing.
6. Starting at the indoor unit located farthest from the outdoor unit, sum the corrected cooling capacity of all indoor units served by the pipe segment for each branch and runout pipe (indoor units and branch distribution units [Multi F MAX systems only]). Record these values next to each segment.
7. Verify the size of the liquid and vapor lines.
8. If a Multi F MAX system, refer to Cut-Sheets “Y-branch Kits” on page 217 and branch distribution units on page 172 to verify the part number of each Y-branch and branch distribution unit based on the connected downstream nominal capacity served.
9. Calculate the equivalent pipe length in feet of each pipe segment. If a Multi F MAX system, Y-branch equivalent lengths should be totaled with the upstream segment only. Use equivalent pipe length data when it is provided with field-purchased fittings. If not available, use the data provided on page 165 to estimate the equivalent length of field-provided pipe and fittings for each segment. Equivalent lengths should be totaled with the upstream segment only.
10. Verify if the equivalent pipe length complies with the limitations in the “Multi F and Multi F MAX Refrigerant Piping System Limitations” tables on pages 166 and 167. If the limitations are exceeded, either reroute the pipe or change the location of the indoor unit, Y-branch fittings and branch distribution units (if Multi F MAX systems), so the design conforms with all limitations.
11. If adjusted as per Step 10 above, verify again if the length of the design complies with the limitations set in “Multi F and Multi F MAX Refrigerant Piping System Limitations” tables on pages 166 and 167.
12. Verify that the manually sized pipe design is acceptable using LATS Multi. When entering the length of pipe segments in LATS Multi software, enter the equivalent pipe length. Account for the additional pressure drop created by elbows, valves, and other fittings present in each segment by adding their respective equivalent pipe length to the actual pipe length.

### Multi F MAX Y-Branch Kit PMBL5620

The LG supplied Y-Branch Kit PMBL5620 MUST be used when two branch distribution units are connected on one Multi F MAX system. Field-supplied fittings are not permitted. Each Y-Branch kit comes with two (2) Y-branches (one for the liquid line and one for the vapor line) and insulation covers.

Y-branches may be installed in horizontal or vertical configurations. When installed vertically, position the Y-branch so the straight-through leg is  $\pm 3^\circ$  of plumb (Figure 50). When installed horizontally, position the Y-branch so the take-off leg is level and shares the same horizontal plane as the straight-through leg  $\pm 10^\circ$  rotation as shown in Figure 50.

Y-branches must be properly installed following instructions in the applicable LG manual. Y-branches should always be installed with the single port facing the outdoor unit and the two-port end facing the branch distribution units (see Figure 48). Do not install Y-branches backwards as refrigerant flow cannot make U-turns. The Y-branch kit must be located at least three (3) feet from the outdoor unit. Provide a minimum of 20 inches between a Y-branch and the branch distribution unit.

It is recommended that when a Y-branch is located in a pipe chase or other concealed space, access doors should be provided for inspection access.

The equivalent pipe length of each Y-branch (1.6') must be added to the main pipe segment entered into LATS piping design software.

Figure 50: Horizontal Configuration End View.

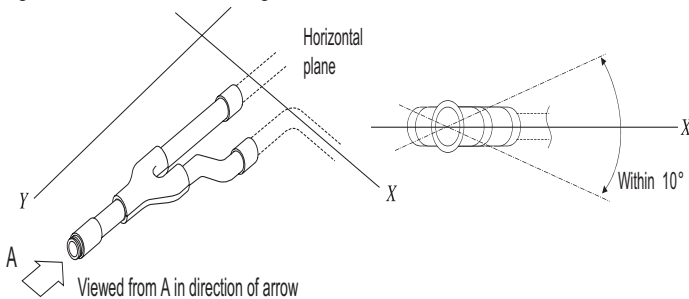

### Y-Branch Kit Insulation

Each Y-branch kit comes with clam-shell type peel-and-stick insulation jackets molded to fit the Y-branch fittings as shown in Figure 51—one for the liquid line, one for the vapor line.

- Check the fit of the Y-branch clam-shell insulation jacket after the Y-branch is installed.
- Mark the pipe where the insulation jacket ends.
- Remove the jacket.
- Install field-provided insulation on the pipes first.
- Peel the adhesive glue protector slip and install the clam-shell jacket over the fitting

Figure 48: Y-Branch Connections.

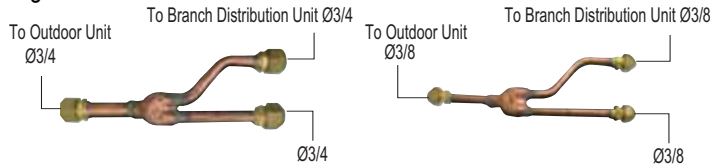
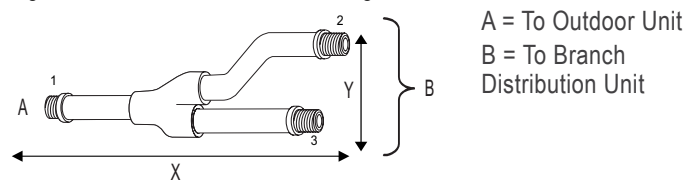

Table 169: Y-Branch Connection Diameters.

Model	Y-Branch Type	Port Identifier (inch)			Dimensions	
		1	2	3	X	Y
PMBL5620	Liquid	3/8	3/8	3/8	13.80	3.24
	Vapor	3/4	3/4	3/4	12.48	3.02

Figure 49: Y-Branch Dimensions Diagram.



### Note:

- Design pressure is 551 psig.
- All dimensions in inches. Tolerance  $\pm 1/4$  inch.
- Images are not to scale.

Figure 51: Y-branch Installation Alignment Specification.

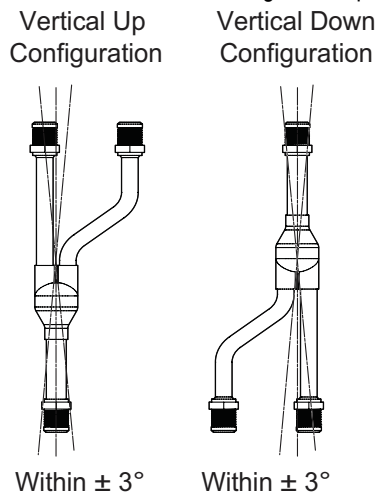
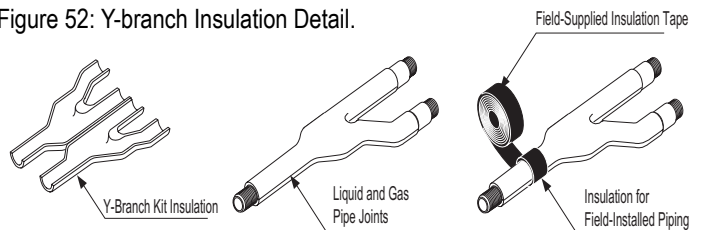

Figure 52: Y-branch Insulation Detail.



# REFRIGERANT PIPING DESIGN

MULTI F  
MULTI F MAX

## Refrigerant Charge

LG Multi F and Multi F MAX outdoor units ship from the factory with a charge of R410A refrigerant. A trim charge may need to be added to take into account additional piping length.

To determine the additional refrigerant that is needed, apply the formulas below, and record the results. If the total additional refrigerant charge value is a negative number, then an additional trim charge does not need to be added to the system.

Table 170: Outdoor Unit Factory Charge.

Outdoor Unit	Factory Charge lbs. of R410A
LMU187HV	4.19
LMU247HV	4.63
LMU369HV	7.72
LMU540HV	9.7

### Multi F Systems

$$\begin{aligned} \text{Additional charge (lbs.)} &= (\text{Installed Length of Branch [A]} - \text{Chargeless Pipe Length [A]}) \times a \\ &+ (\text{Installed Length of Branch [B]} - \text{Chargeless Pipe Length [A]}) \times a \\ &+ (\text{Installed Length of Branch [C]} - \text{Chargeless Pipe Length [A]}) \times a \\ &+ (\text{Installed Length of Branch [D]} - \text{Chargeless Pipe Length [A]}) \times a \\ &- CF (\text{Correction Factor}) \times 5.29 \end{aligned}$$

#### Note:

- Number of installed length of branches depends on the specifications of the outdoor unit model.
- CF = Maximum number of connectable indoor units – Total number of connected indoor units

Table 171: Multi F Outdoor Unit Piping Specifications.

Outdoor Unit Model	Max. Piping Length for One Branch (ft.)	Max. Total System Piping Length (ft.)	Chargeless Pipe Length per Branch (A) (ft.)	Additional Charge Needed (a) (oz./ft.)
LMU187HV	82	164	24.6	0.22
LMU247HV	82	246	24.6	0.22
LMU369HV	82	246	24.6	0.22

Figure 53: Multi F Additional Refrigerant Charge Example.

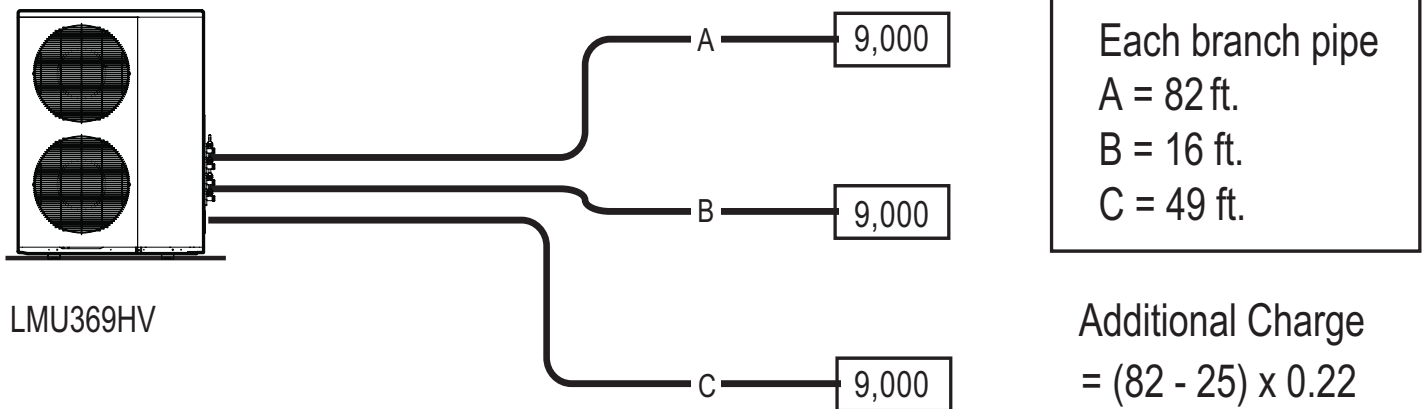

$$\begin{aligned} \text{Additional Charge} &= (82 - 25) \times 0.22 \\ &+ (16 - 25) \times 0.22 \\ &+ (49 - 25) \times 0.22 \\ &- (4 - 3) \times 5.29 \\ &= 10.55 \text{ oz.} \end{aligned}$$

### Multi F MAX Systems

Additional charge (lbs.) = (Total Main Piping Length [A] - Chargeless Pipe Length of Main Pipe [A]) x a  
 + (Installed Length of Branch [B1] - Chargeless Pipe Length [B]) x b  
 + (Installed Length of Branch [B2] - Chargeless Pipe Length [B]) x b  
 + (Installed Length of Branch [B3] - Chargeless Pipe Length [B]) x b ...  
 - CF (Correction Factor) x 3.53

**Note:**

- Number of installed length of branches depends on system specifications.
- CF = Maximum number of connectable indoor units - Total number of connected indoor units

Table 172: Multi F MAX Outdoor Unit Piping Specifications.

Outdoor Unit Model	Main Piping Length		Branch Piping Length	
	Chargeless Pipe Length of Main Pipe (A) (ft.)	Additional Charge Needed (a) (oz./ft.)	Chargeless Pipe Length per Branch Pipe (B) (ft.)	Additional Charge Needed (b) (oz./ft.)
LMU540HV	16.4	0.54	16.4	0.22

Figure 54: Multi F MAX Additional Refrigerant Charge Example.

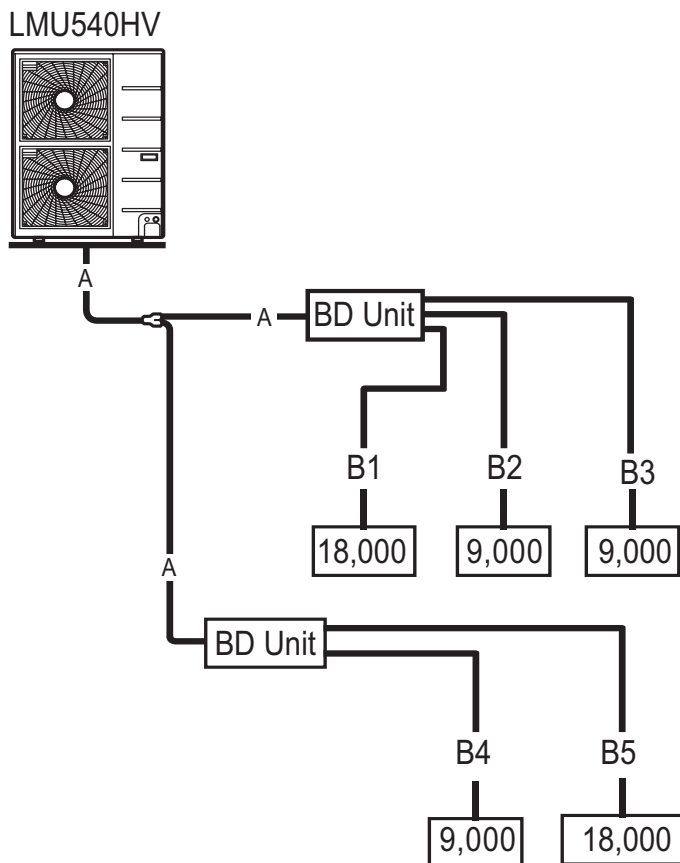

- Total main pipe (A) = 60 ft.
- Each branch pipe  
 B1 = 49 ft.  
 B2 = 17 ft.  
 B3 = 17 ft.  
 B4 = 10 ft.  
 B5 = 23 ft.

Additional Charge  
 = (60 - 16.4) x 0.54  
 + (49 - 16.4) x 0.22  
 + (17 - 16.4) x 0.22  
 + (17 - 16.4) x 0.22  
 + (10 - 16.4) x 0.22  
 + (23 - 16.4) x 0.22  
 - (8 - 5) x 3.53  
 = 20.43 oz.

# REFRIGERANT PIPING DESIGN

MULTI F  
MULTI F MAX

## Selecting Field-Supplied Copper Tubing

Copper is the only approved refrigerant pipe material for use with LG Multi F air conditioning products, and LG recommends hard-drawn rigid type “K” or “L”, or annealed-tempered, copper pipe.

- Drawn temper (rigid) ACR copper tubing is available in sizes 3/8 through 2-1/8 inches (ASTM B 280, clean, dry, and capped).
- Annealed temper (soft) ACR copper tubing is available in sizes 1/4 through 2-1/8 inches (ASTM B 280, clean, dry, and capped).

Tube wall thickness should meet local code requirements and be approved for an operating pressure of 551 psi. If local code does not specify wall thickness, LG suggests using tube thickness per the table below. When bending tubing, use the largest radii possible to reduce the equivalent length of installed pipe; also, bending radii greater than ten (10) pipe diameters can minimize pressure drop. Be sure no traps or sags are present when rolling out soft copper tubing coils.

Table 173: ACR Copper Tubing Material.

Type	Seamless Phosphorous Deoxidized
Class	UNS C12200 DHP
Straight Lengths	H58 Temper
Coils	O60 Temper

Table 174: Piping Tube Thicknesses.

OD (in)	1/4	3/8	1/2	5/8	3/4
Material	Rigid Type “K” or “L” - Soft ACR Acceptable			Rigid Type “K” or “L” Only	
Min. Bend Radius (in)	.563	.9375	1.5	2.25	3.0
Min. Wall Thickness (in)	.031	.031	.031	.039	.039

## Copper Expansion and Contraction

Under normal operating conditions, the vapor pipe temperature of a Multi F system can vary as much as 280°F. With this large variance in pipe temperature, the designer must consider pipe expansion and contraction to avoid pipe and fitting fatigue failures. Refrigerant pipe, along with the insulation jacket, form a cohesive unit that expands and contracts together. During system operation, thermal heat transfer occurs between the pipe and the surrounding insulation.

If the pipe is mounted in free air space, no natural restriction to movement is present if mounting clamps are properly spaced and installed. When the refrigerant pipe is mounted underground in a utility duct stacked among other pipes, natural restriction to linear movement is present. In extreme cases, the restrictive force of surface friction between insulating jackets could become so great that natural expansion ceases and the pipe is “fixed” in place. In this situation, opposing force caused by change in refrigerant fluid/vapor temperature can lead to pipe/fitting stress failure.

The refrigerant pipe support system must be engineered to allow free expansion to occur. When a segment of pipe is mounted between two fixed points, provisions must be provided to allow pipe expansion to naturally occur. The most common method is the inclusion of expansion Loop or U-bends. See Figure 55 on page 205. Each segment of pipe has a natural fixed point where no movement occurs. This fixed point is located at the center point of the segment assuming the entire pipe is insulated in a similar fashion. The natural fixed point of the pipe segment is typically where the expansion Loop or U-bend should be. Linear pipe expansion can be calculated using the following formula:

$$LE = C \times L \times (T_r - T_a) \times 12$$

LE	=	Anticipated linear tubing expansion (in.)
C	=	Constant (For copper = $9.2 \times 10^{-6}$ in./in.°F)
L	=	Length of pipe (ft.)
T <sub>R</sub>	=	Refrigerant pipe temperature (°F)
T <sub>a</sub>	=	Ambient air temperature (°F)
12	=	Inches to feet conversion (12 in./ft.)

1. From Table 175, find the row corresponding with the actual length of the straight pipe segment.
2. Estimate the minimum and maximum temperature of the pipe. In the column showing the minimum pipe temperature, look up the anticipated expansion distance. Do the same for the maximum pipe temperature.
3. Calculate the difference in the two expansion distance values. The result will be the anticipated change in pipe length.

### Example:

A Multi F MAX system is installed and the design shows that there is a 100 foot straight segment of tubing between a Y-branch and a branch distribution unit. In heating, this pipe transports hot gas vapor to the indoor units at 120°F. In cooling, the same tube is a suction line returning refrigerant vapor to the outdoor unit at 40°F. Look up the copper tubing expansion at each temperature and calculate the difference.

### Vapor Line

Transporting Hot Vapor: 100 ft. pipe at 120°F = 1.40 in.  
Transporting Suction Vapor: 100 ft. pipe at 40°F = 0.40 in.  
Anticipated Change in Length: 1.40 in. – 0.40 in. = 1.00 in.

### Liquid Line

The liquid temperature remains the same temperature; only the direction of flow will reverse. Therefore, no significant change in length of the liquid line is anticipated.

When creating an expansion joint, the joint height should be a minimum of two times the joint width. Although different types of expansion arrangements are available, the data for correctly sizing an Expansion Loop is provided in Table 176. Use soft copper with long radius bends on longer runs or long radius elbows for shorter pipe segments. Using the anticipated linear expansion (LE) distance calculated, look up the Expansion Loop or U-bend minimum design dimensions. If other types of expansion joints are chosen, design per ASTM B-88 Standards.

Table 175: Linear Thermal Expansion of Copper Tubing in Inches.

Pipe Length <sup>1</sup>	Fluid Temperature °F																			
	35°	40°	45°	50°	55°	60°	65°	70°	75°	80°	85°	90°	95°	100°	105°	110°	115°	120°	125°	130°
10	0.04	0.04	0.05	0.06	0.06	0.07	0.08	0.08	0.09	0.09	0.10	0.10	0.11	0.11	0.11	0.12	0.13	0.14	0.15	0.15
20	0.08	0.08	0.10	0.12	0.13	0.14	0.15	0.16	0.17	0.18	0.19	0.20	0.21	0.22	0.22	0.23	0.26	0.28	0.29	0.30
30	0.12	0.12	0.15	0.18	0.20	0.21	0.23	0.24	0.26	0.27	0.29	0.30	0.32	0.33	0.32	0.35	0.39	0.42	0.44	0.45
40	0.16	0.16	0.20	0.24	0.26	0.28	0.30	0.32	0.34	0.36	0.38	0.40	0.42	0.44	0.43	0.46	0.52	0.56	0.58	0.60
50	0.20	0.20	0.25	0.30	0.33	0.35	0.38	0.40	0.43	0.45	0.48	0.50	0.53	0.55	0.54	0.58	0.65	0.70	0.73	0.75
60	0.24	0.24	0.30	0.36	0.39	0.42	0.45	0.48	0.51	0.54	0.57	0.60	0.63	0.66	0.65	0.69	0.78	0.84	0.87	0.90
70	0.28	0.28	0.35	0.42	0.46	0.49	0.53	0.56	0.60	0.63	0.67	0.70	0.74	0.77	0.76	0.81	0.91	0.98	1.02	1.05
80	0.32	0.32	0.40	0.48	0.52	0.56	0.60	0.64	0.68	0.72	0.76	0.80	0.84	0.88	0.86	0.92	1.04	1.12	1.16	1.20
90	0.36	0.36	0.45	0.54	0.59	0.63	0.68	0.72	0.77	0.81	0.86	0.90	0.95	0.99	0.97	1.04	1.17	1.26	1.31	1.35
100	0.40	0.40	0.50	0.60	0.65	0.70	0.75	0.80	0.85	0.90	0.95	1.00	1.05	1.10	1.08	1.15	1.30	1.40	1.45	1.50
120	0.48	0.48	0.60	0.72	0.78	0.84	0.90	0.96	1.02	1.08	1.14	1.20	1.26	1.32	1.30	1.38	1.56	1.68	1.74	1.80
140	0.56	0.56	0.70	0.84	0.91	0.98	1.05	1.12	1.19	1.26	1.33	1.40	1.47	1.54	1.51	1.61	1.82	1.96	2.03	2.10
160	0.64	0.64	0.80	0.96	1.04	1.12	1.20	1.28	1.36	1.44	1.52	1.60	1.68	1.76	1.73	1.84	2.08	2.24	2.32	2.40
180	0.72	0.72	0.90	1.08	1.17	1.26	1.35	1.44	1.53	1.62	1.71	1.80	1.89	1.98	1.94	2.07	2.34	2.52	2.61	2.70

<sup>1</sup>Pipe length baseline temperature = 0°F. "Expansion of Carbon, Copper and Stainless Steel Pipe," *The Engineers' Toolbox*, www.engineeringtoolbox.com.

Figure 55: Coiled Expansion Loops and Offsets.

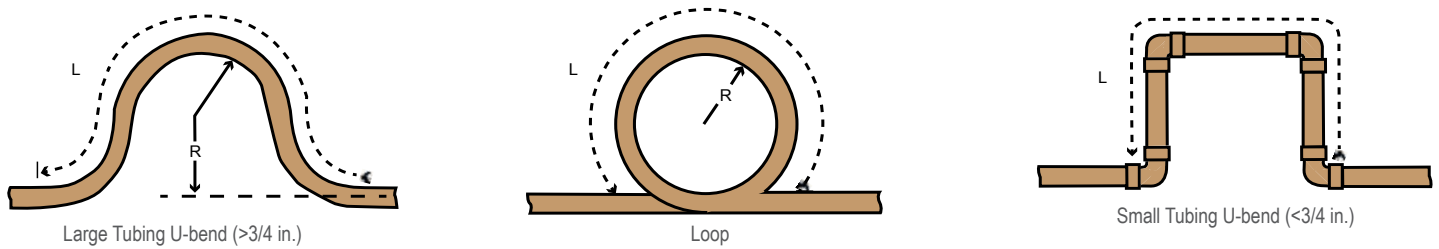

Table 176: Radii of Coiled Expansion Loops and Developed Lengths of Expansion Offsets.

Anticipated Linear Expansion (LE) (inches)		Nominal Tube Size (OD) inches			
		1/4	3/8	1/2	3/4
1/2	R <sup>1</sup>	6	7	8	9
	L <sup>2</sup>	38	44	50	59
1	R <sup>1</sup>	9	10	11	13
	L <sup>2</sup>	54	63	70	83
1-1/2	R <sup>1</sup>	11	12	14	16
	L <sup>2</sup>	66	77	86	101
2	R <sup>1</sup>	12	14	16	19
	L <sup>2</sup>	77	89	99	117
2-1/2	R <sup>1</sup>	14	16	18	21
	L <sup>2</sup>	86	99	111	131
3	R <sup>1</sup>	15	17	19	23
	L <sup>2</sup>	94	109	122	143
3-1/2	R <sup>1</sup>	16	19	21	25
	L <sup>2</sup>	102	117	131	155
4	R <sup>1</sup>	17	20	22	26
	L <sup>2</sup>	109	126	140	166

<sup>1</sup>R = Centerline Length of Pipe.

<sup>2</sup>L = Centerline Minimum Radius (inches).

### Field-Provided Isolation Ball Valves

LG recommends installing field-supplied ball valves with Schrader ports at each indoor unit. Full-port isolation ball valves with Schrader ports (positioned between valve and indoor unit) rated for use with R410A refrigerant should be used on both the liquid and vapor lines.

If valves are not installed and a single indoor unit needs to be removed or repaired, the entire system must be shut down and evacuated. If isolation ball valves are installed, and an indoor unit needs to be repaired, the unaffected indoor units can remain operational with readdressing and the proper combination ratio. Reclamation of refrigerant, then, can be restricted to a single indoor unit.

For Multi F MAX systems, position valves with a minimum distance of three (3) to six (6) inches of pipe on either side of the valve, and placed between six (6) and twelve (12) inches from the first upstream Y-branch or branch distribution unit. If ball valves are installed away from the first Y-branch and / or branch distribution unit and closer to the indoor unit, oil may accumulate where it cannot be returned to the outdoor unit and may cause a shortage of oil in the compressor.

Valves shall be easily accessible for service. If necessary, install drywall access doors or removable ceiling panels, and position the valves to face the access door or ceiling panel opening. Mount valves with adequate space between them to allow for placement of adequate pipe insulation around the valves. Recommended best practice is to clearly label and document locations of all service valves, Y-branches, and branch distribution units. The equivalent pipe length of each ball valve must be added to each pipe segment entered into the LATS program.

### Obstacles

When an obstacle, such as an I-beam or concrete T, is in the path of the planned refrigerant pipe run, it is best practice to route the pipe over the obstacle. If adequate space is not available to route the insulated pipe over the obstacle, then route the pipe under the obstacle. In either case, it is imperative the horizontal section of pipe above or below the obstacle be a minimum of three (3) times greater than the longest vertical rise (or fall) distance.

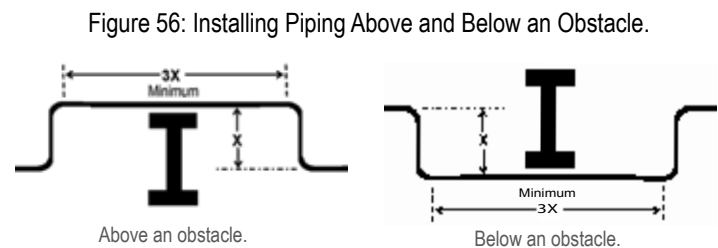

### Pipe Slope

The horizontal pipe slope cannot exceed 10° up or down.

### In-line Refrigeration Components

Components such as oil traps, solenoid valves, filter-dryers, sight glasses, tee fittings, and other after-market accessories are not permitted on the refrigerant piping system between the outdoor units and the indoor / branch distribution units. Multi F and Multi F MAX systems are provided with redundant systems that assure oil is properly returned to the compressor. Sight-glasses and solenoid valves may cause vapor to form in the liquid stream. Over time, dryers may deteriorate and introduce debris into the system. The designer and installer should verify the refrigerant piping system is free of traps, sagging pipes, sight glasses, filter dryers, etc.

### No Pipe Size Substitutions

Use only the pipe size selected by the LATS Multi pipe system design software or as conveyed in the product installation instructions. Using a different size is prohibited and may result in a system malfunction or failure to work at all.

### Inserts and Pipe Supports

#### Inserts

An insert can be installed into a floor or beam before the concrete sets so that fittings such as ducts, pipes, or suspension bolts can be added at a later time. Decide where the inserts should be placed before support installation.

#### Pipe Supports

#### Note:

*A properly installed pipe system should be adequately supported to avoid pipe sagging. Sagging pipes become oil traps that lead to equipment malfunction.*

Pipe supports should never touch the pipe wall; supports shall be installed outside (around) the primary pipe insulation jacket (see Figure 57). Insulate the pipe first because pipe supports shall be installed outside (around) the primary pipe insulation jacket. Clevis hangers should be used with shields between the hangers and insulation.

Field provided pipe supports should be designed to meet local codes. If allowed by code, use fiber straps or split-ring hangers suspended from the ceiling on all-thread rods (fiber straps or split ring hangers can be used as long as they do not compress the pipe insulation). Place a second layer of insulation over the pipe insulation jacket to prevent chafing and compression of the primary insulation within the confines of the support pipe clamp.

A properly installed pipe system will have sufficient supports to avoid pipes from sagging during the life of the system. As necessary, place supports closer for segments where potential sagging could occur. Maximum spacing of pipe supports shall meet local codes. If local codes do not specify pipe support spacing, pipe shall be supported a maximum of 5 feet on center for straight segments of pipe up to 3/4" outside diameter size.

Wherever the pipe changes direction, place a hanger within twelve (12) inches on one side and within twelve to nineteen (12 to 19) inches of the bend on the other side as shown in Figure 59. Support piping at indoor units as shown in Figure 60. Support Y-Branch fittings as shown in Figure 61.

Figure 57: Installing an Insert Into a Concrete Beam.

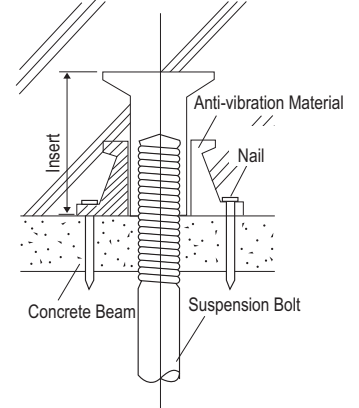

Figure 58: Pipe Hanger Details.

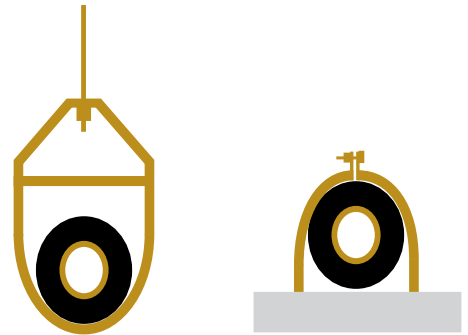

Figure 59: Typical Pipe Support Location—Change in Pipe Direction.

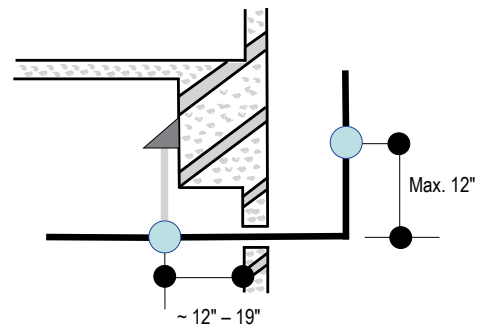

Figure 60: Pipe Support at Indoor Unit.

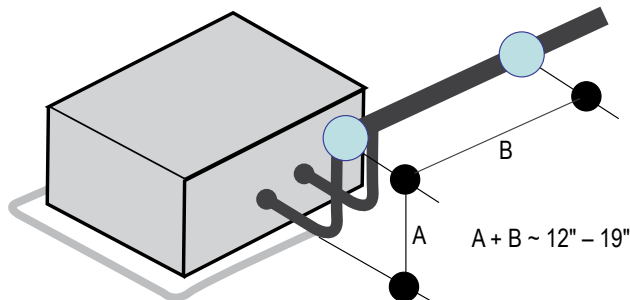
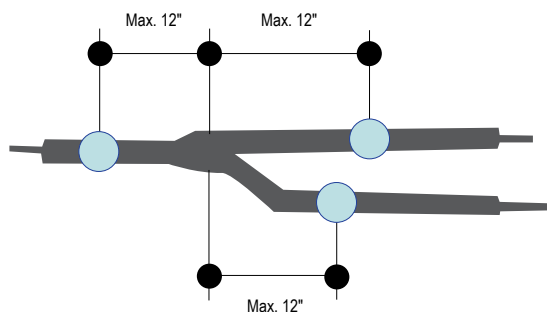

Figure 61: Pipe Support at Y-branch Fitting.



### Examples of Supports

Figure 62: U-Bolt Support with Insulation.

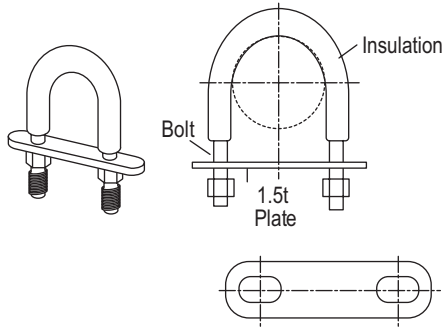

Figure 63: O-Ring Support with Insulation.

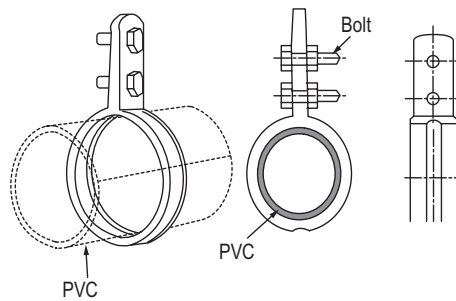
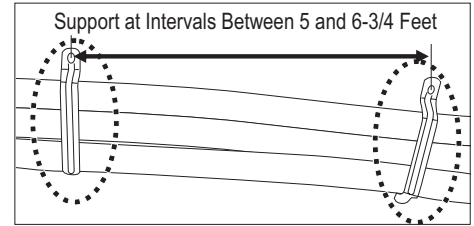

Figure 64: Saddle-Type Support.



### Note:

*Do not compress the insulation with the saddle-type support. If the insulation is compressed, it may tear open and allow condensation to generate during product operation.*

Figure 65: U-Bolt Support with an Insulated Pipe.

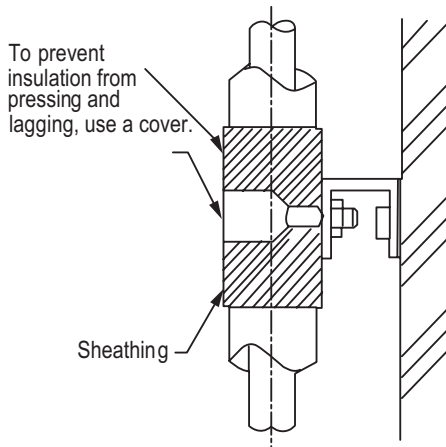

Figure 66: O-Ring Band Support with an Insulated Pipe.

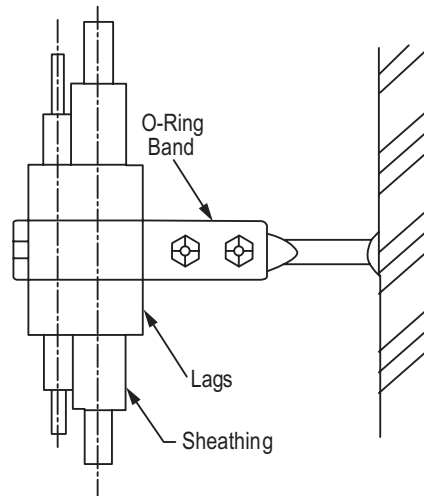

Figure 67: One-Point Down-Stop Support (>441 lbs.).

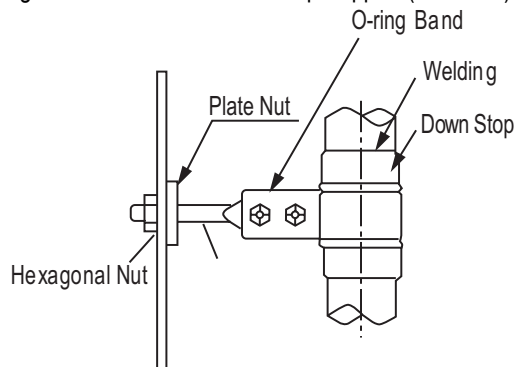
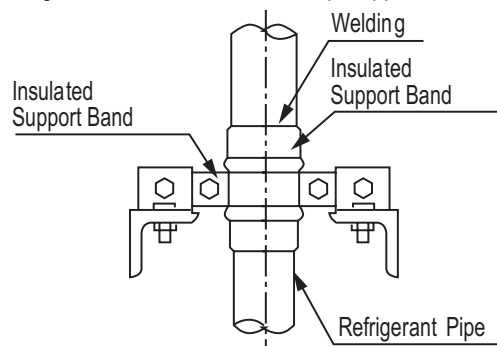

Figure 68: Two-Point Down-Stop Support.



### Pipe Sleeves at Penetrations

LG requires that all pipe penetrations through walls, floors, and pipes buried underground be routed through a properly insulated sleeve that is sufficiently sized to provide free movement of the pipe and does not compress the insulation. Underground refrigerant pipe shall be routed inside a protective sleeve to prevent insulation deterioration. Also follow federal, state, and local regulations and codes when choosing a sleeve type.

### Note:

*Diameter of penetrations shall be determined by pipe diameter plus the thickness of the insulation.*

### For example:

Diameter of Gas Piping:	1/2"
Diameter of Liquid Piping:	1/4"
Thickness of Gas Piping Insulation:	0.4" x 2
Thickness of Liquid Piping Insulation:	0.4" x 2
Surplus:	0.8"
Sleeve diameter (total):	3.1" minimum

Figure 69: Pipe Sleeve Options.

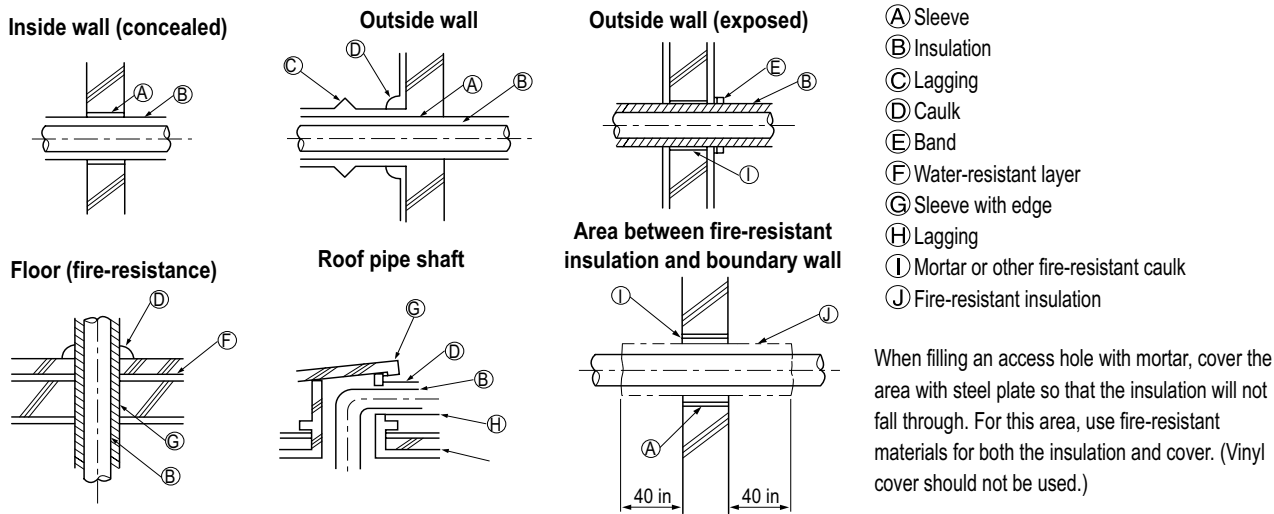

### Underground Refrigerant Piping

Refrigerant pipe installed underground should be routed inside a vapor tight protective sleeve to prevent insulation deterioration and water infiltration. Refrigerant pipe installed inside underground casing must be continuous without any joints. Underground refrigerant pipe must be located at a level below the frost line.

Figure 70: Typical Arrangement of Refrigerant Pipe and Cable(s) in a Utility Conduit.

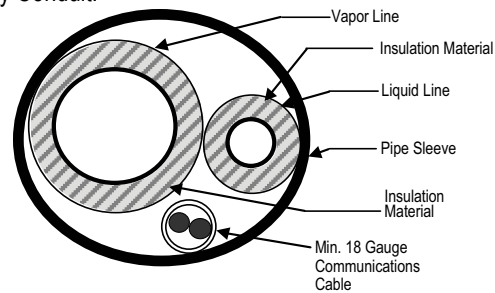

Figure 71: Underground Refrigerant Piping.



Table 177: Utility Conduit Sizes.

Liquid Pipe <sup>1</sup>	Vapor Pipe <sup>1</sup>		
	1/2 (2.0 <sup>2,5</sup> )	5/8 (2-1/8 <sup>2,5</sup> )	3/4 (2-1/4 <sup>2,5</sup> )
1/4 (1.0) <sup>3</sup>	4	4	4
3/8 (1-1/8) <sup>3</sup>	4	4	5
1/2 (1-1/2) <sup>4</sup>	5	5	5
5/8 (1-5/8) <sup>4</sup>	5	5	5
3/4 (1-3/4) <sup>4</sup>	5	5	5

<sup>1</sup>OD pipe diameter in inches; Values in parenthesis ( ) indicate OD of pipe with insulation jacket.

<sup>2</sup>Diameter of pipe with insulation. Thickness of pipe insulation is typical. Actual required thickness may vary based on surrounding ambient conditions and should be calculated and specified by the design engineer.

<sup>3</sup>Insulation thickness (value in parenthesis) = 3/8 inch.

<sup>4</sup>Insulation thickness (value in parenthesis) = 1 inch.

<sup>5</sup>Insulation thickness (value in parenthesis) = 3/4 inch.

### Multi F Outdoor Unit to Indoor Unit Piping Connections

#### Note:

##### Avoid Pipe Damage

- When routing field-provided piping, avoid damaging the outdoor unit from excessive vibration.
- Correctly route the piping so it does not make contact with mounting bolts. Allow room for field installation.
- Properly insulate the liquid and gas lines separately up to the point of connection at the unit frame.
- See Table 179 for Multi F outdoor unit connection types.

Table 178: Outdoor Unit Piping Connections.

Outdoor Unit Piping Connections	LMU187HV	LMU247HV	LMU369HV
Liquid Line Connection (in., OD) x Qty.	1/4 x 2	1/4 x 3	1/4 x 4
Vapor Line Connection (in., OD) x Qty.	3/8 x 2	3/8 x 3	3/8 x 4

Table 179: Indoor Unit Piping Connections.

Indoor Unit Capacity	Vapor Line Connection (in., OD)	Liquid Line Connection (in., OD)
9,000 Btu/h	Ø3/8	Ø1/4
12,000 Btu/h		
18,000 Btu/h	Ø1/2	
24,000 Btu/h		

Figure 72: Multi F Refrigerant Pipe Connections (LMU369HV shown as example).

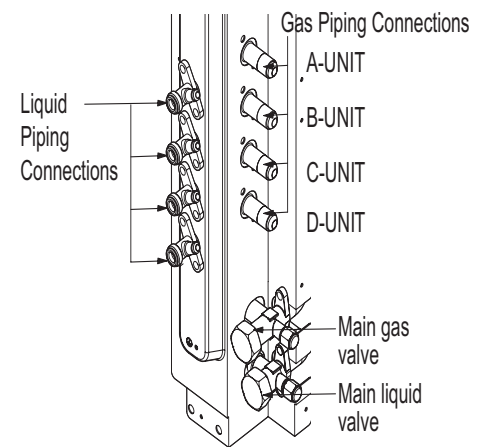

Connection sockets (included as a factory-supplied accessory with the indoor units) may need to be used when piping the indoor units to the outdoor unit.

Table 180: Connection Socket Dimensions.

Indoor Unit Capacity	Vapor (in., OD)		Liquid (in., OD)	
	A	B	A	B
18,000 Btu/h	Ø3/8 → Ø1/2		N/A	
24,000 Btu/h				

Figure 73: Connection Socket Diagram.

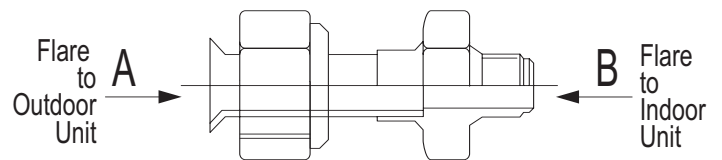

#### Using the Connection Socket

1. Align the center of the piping sections and tighten the flare nut by hand.
2. Tighten the flare nut with a torque wrench, using the arrows on the wrench as a guide, until a click is heard.

Figure 74: Performing Connections.

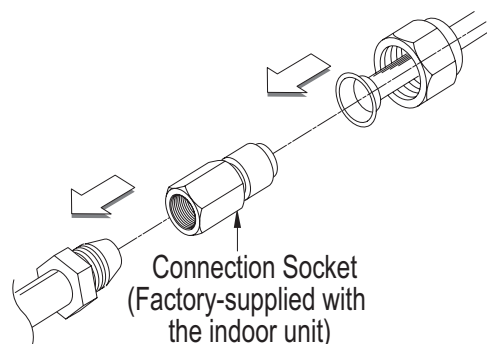

### Multi F MAX Outdoor Unit System Piping Connections

**Note:**

**Avoid Pipe Damage**

- When routing field-provided piping, avoid damaging the outdoor unit from excessive vibration.
- Correctly route the piping so it does not make contact with mounting bolts. Allow room for field installation.
- Properly insulate the liquid and gas lines separately up to the point of connection at the unit frame.
- See Table 181 for Multi F MAX outdoor unit connection types.

Table 181: Outdoor Unit Piping Connections.

Outdoor Unit Piping Connections	LMU540HV
Liquid Line Connection (in., OD) x Qty.	3/8 x 1
Vapor Line Connection (in., OD) x Qty.	3/4 x 1

### Branch Distribution to Indoor Unit Piping Connections

- Install indoor unit liquid and vapor refrigerant pipes (and connection wiring) to the appropriate branch distribution ports.
- Clearly note on the indoor unit's refrigerant piping (liquid, vapor) which branch distribution port it is connected to (A, B, C, D).

Table 182: Branch Distribution Unit Piping Connections.

Branch Distribution Unit	PMBD3620	PMBD3630	PMBD3640	PMBD3641
<b>Piping Connections to Outdoor Unit</b>				
Liquid (in., OD) x Qty.	Ø3/8 x 1			
Vapor (in., OD) x Qty.	Ø3/4 x 1			
<b>Piping Connections to Indoor Units</b>				
Liquid (in., OD) x Qty.	Ø1/4 x 2	Ø1/4 x 3	Ø1/4 x 4	Ø1/4 x 3, Ø3/8 x 1
Vapor (in., OD) x Qty.	Ø3/8 x 2	Ø3/8 x 3	Ø3/8 x 4	Ø3/8 x 3, Ø5/8 x 1

Figure 75: Branch Distribution Ports to Indoor Units.

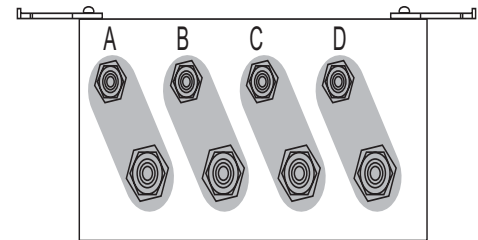

Table 183: Indoor Unit Piping Connections.

Indoor Unit Capacity	Vapor Line Connection (in., OD)	Liquid Line Connection (in., OD)
9,000 Btu/h	Ø3/8	Ø1/4
12,000 Btu/h		
18,000 Btu/h	Ø1/2	
24,000 Btu/h		
36,000 Btu/h	Ø5/8	Ø3/8

Connection sockets (included as a factory-supplied accessory with the indoor units) may need to be used when piping the indoor units to the branch distribution unit.

Table 184: Connection Socket Dimensions.

Indoor Unit Capacity	Vapor (in., OD)		Liquid (in., OD)	
	A	B	A	B
18,000 Btu/h	Ø3/8 → Ø1/2		N/A	
24,000 Btu/h				
36,000 Btu/h	Ø1/2 → Ø5/8		Ø1/4 → Ø3/8	

Figure 76: Connection Socket Diagram.

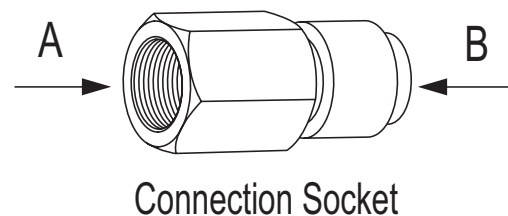

### Multi F MAX Outdoor Unit System Piping Connections, continued.

1. Align the center of the piping sections and tighten the flare nut by hand.
2. Tighten the flare nut with a torque wrench, using the arrows on the wrench as a guide, until a click is heard.
3. Wrap insulation around the connection.

Figure 77: Possible Branch Distribution Unit to Indoor Unit Connections.

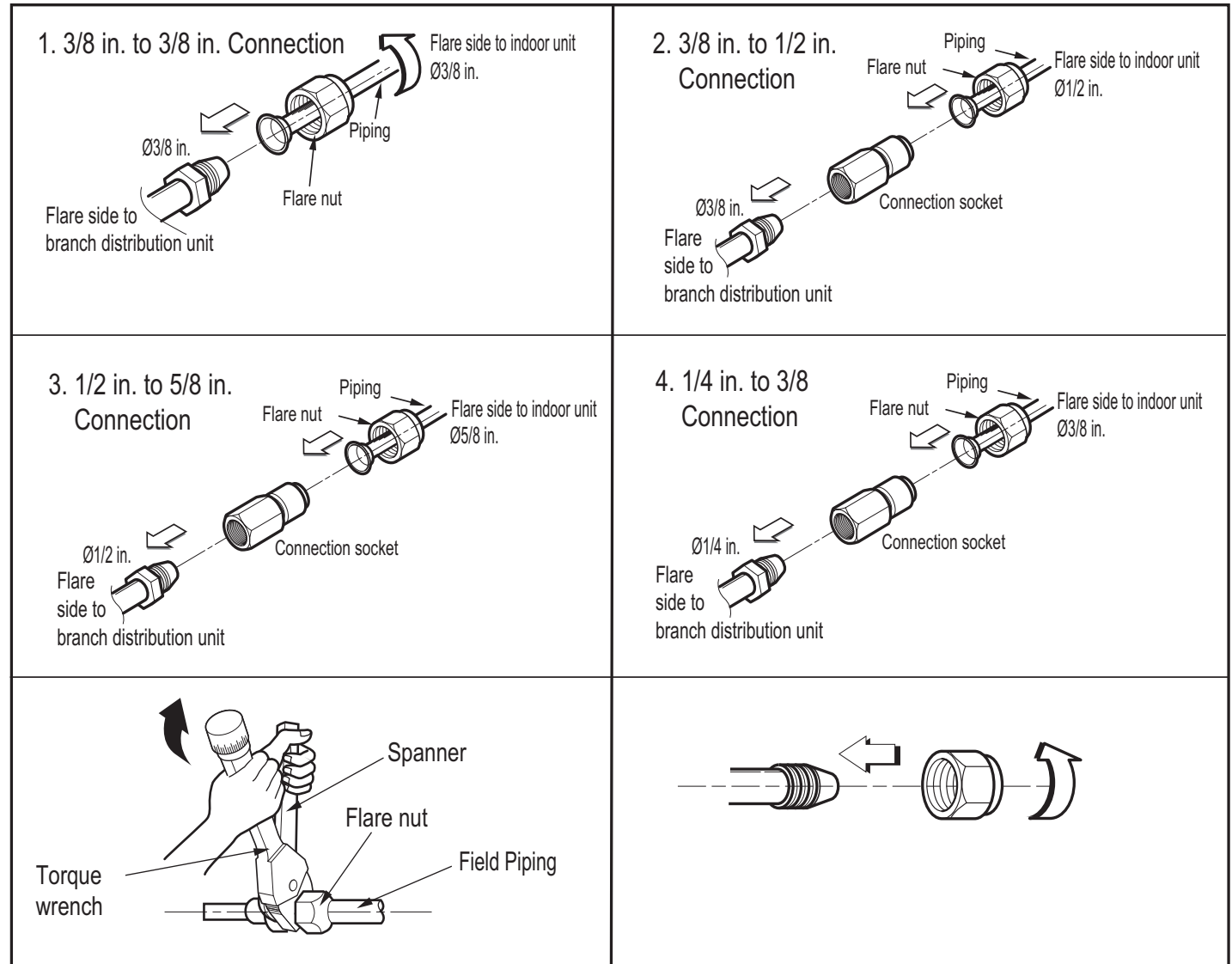

### Brazing Practices

**Note:**

Keep the piping system free of contaminants and debris such as copper burrs, slag, or carbon dust during installation.

- All joints are brazed in the field. Multi F refrigeration system components contain very small capillary tubes, small orifices, electronic expansion valves, oil separators, and heat exchangers that can easily become blocked.
  - Store pipe stock in a dry place; keep stored pipe capped and clean.
  - Blow clean all pipe sections with dry nitrogen before assembly.
- Proper system operation depends on the installer using best practices and utmost care while assembling the piping system.
  - Use adapters to assemble different sizes of pipe.
  - Do not use flux, soft solder, or anti-oxidant agents.
  - Use a tubing cutter; do not use a saw to cut pipe. De-burr and clean all cuts before assembly.

Figure 78: Refrigerant Pipe Brazing.

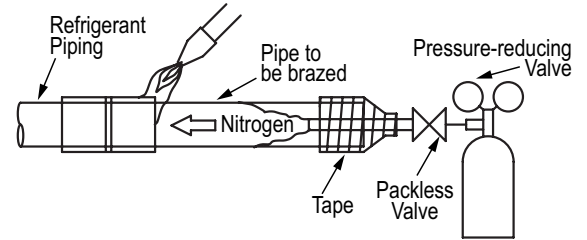

3. Brazing Joints:

- Use a dry nitrogen purge operating at a minimum pressure of three (3) psig and maintain a steady flow.
- Use a 15% silver phosphorous copper brazing alloy to avoid overheating and produce good flow.
- Protect isolation valves, electronic expansion valves, and other heat-sensitive control components from excessive heat with a wet rag or a heat barrier spray product

### Flare Connection Practices

**Note:**

Improperly installed flare connections can lead to refrigerant leaks.

- Place a couple of drops of refrigerant oil on the opening rim of the flare before assembling. Take care not to add any contaminants.
- Align the center of the refrigerant pipe and corresponding connection and tighten the flare nut by hand.
- Following the guidelines as outlined in Table 185 for the amount of torque to use, tighten the flare nut with a torque wrench until the wrench clicks.
- When flare is sufficiently tightened and the system has been tested for refrigerant leaks, wrap insulation around the connection.

Figure 79: Flare Connection, Isometric View.

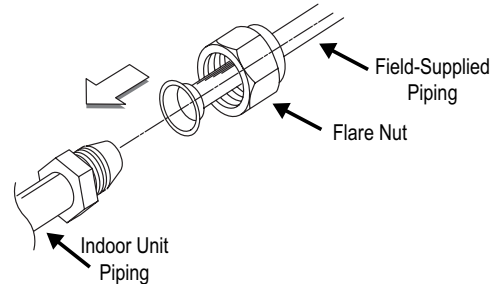
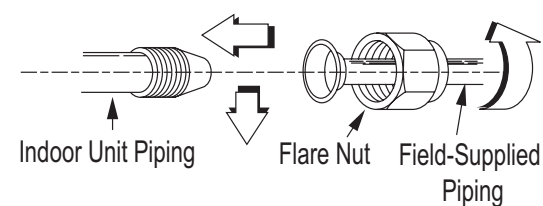

Figure 80: Flare Connection, Side View.



⚠ When tightening the flare unit with a torque wrench, ensure the direction for tightening follows the arrow on the wrench.

Figure 81: Using the Torque Wrench.

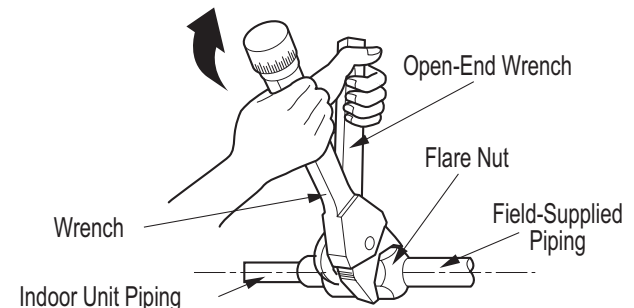

Table 185: Torque Wrench Tightening.

Piping O.D. (in.)	Torque (lbs. / ft.)
1/4	13-18
3/8	24.6-30.4
1/2	39.8-47.7
5/8	45.6-59.3
3/4	71.6-87.5

## Piping Insulation

### Refrigerant Piping System Insulation

All refrigerant piping including Y-branch connections, field-provided isolation ball valves, service valves, and elbows shall be completely insulated using closed cell pipe insulation.

To prevent heat loss/heat gain through the refrigerant piping, all refrigerant piping including liquid lines and vapor lines shall be insulated separately. Insulation shall be a minimum 1/2" thick, and thickness may need to be increased based on ambient conditions and local codes.

All insulation joints shall be glued with no air gaps. Insulation material shall fit snugly against the refrigeration pipe with no air space between it and the pipe. Insulation passing through pipe hangers, inside conduit, and/or sleeves must not be compressed. Protect insulation inside hangers and supports with a second layer. All pipe insulation exposed to the sun and outdoor elements shall be properly protected with PVC, aluminum vapor barrier, or alternatively placed in a weather-resistant enclosure such as a pipe rack with a top cover; and meet local codes. Pay special attention to insulating the pipes installed in the ceiling plenum.

LG-provided Y-branches are shipped from the factory with pre-formed peel-and-stick foam insulation jackets, with a 1.84 lb./ft.<sup>3</sup> density, 1/2" thickness, and meet UL94 MF-1 flammability.

The design engineer should perform calculations to determine if the factory-supplied insulation jackets are sufficient to meet local codes and avoid sweating. Maximum refrigerant piping temperature is +227°F; minimum refrigerant piping temperature is -4°F. Add additional insulation if necessary. Check the fit of the insulation jacket after the header fitting and all run-out pipes are installed. Mark all pipes at the point where the insulation jacket ends. Remove the jacket. Install field provided insulation on the run-out and main trunk pipes first. Install the LG-provided insulation plugs on the ends of all unused header ports. Peel the adhesive glue protector slip from the insulation jacket and install the clam-shell jacket over the fitting.

### Minimum Refrigerant Pipe Ethylene Propylene Diene Methylene (EPDM) Insulation Wall Thickness Requirements

**Note:**

*Follow local codes when selecting EPDM insulation wall thickness.*

Table 186: Insulation Guidelines for Typical and Special Circumstances.

Classification		Air-conditioned location		Non-air conditioned location	
		1. Typical location	2. Special location	3. Typical location	4. Special location
Liquid pipe	ø1/4 inches	1/2 inches	1/2 inches	1/2 inches	1/2 inches
	ø3/8 inches				
	≥ø1/2 inches				
Vapor pipe	ø3/8 inches	1/2 inches	3/4 inches	3/4 inches	1 inch
	ø1/2 inches				
	ø5/8 inches				
	ø3/4 inches				

**1. Air-conditioned, Typical location: When the piping passes through an indoor area where the indoor unit operates.**

- Apartment, classroom, office, mall, hospital, etc.

**2. Air-conditioned, Special location**

1. When the location is air conditioned, but there is severe temperature/humidity difference due to high ceilings
  - Church, auditorium, theater, lobby, etc.
2. When the location is air conditioned, but internal temperature/humidity are high
  - Bathroom, swimming pool, locker room, etc.

**3. Non-air conditioned, Typical location: When the piping passes through an indoor area where the indoor unit does not operate.**

- Hallway or a dormitory or school, etc.

**4. Non-air conditioned, Special location: If conditions 1 and 2 below are present.**

1. When the piping passes through an indoor area where the indoor unit does not operate.
2. When the humidity is high and there is no air flow in the location where the piping is installed.
  - The thickness of the above insulation material is based on heat conductivity of 0.61 Btu/in/h/ft<sup>2</sup>/°F.

### Condensate Drain Piping

#### Outdoor Units

Outdoor unit requires condensate drain piping. Condensate drain pipe is constructed with materials approved by local code. See pages 191 to 196 for information in reference to outdoor unit placement and condensate drainage.

#### Indoor Units

All indoor units generate water during cooling operation, therefore, how to properly handle this condensation must be considered. Some indoor units include factory-installed drain pumps; others apply the gravity drain method.

Depending on the location of the indoor unit, condensation can be drained directly to the outside of the building, or a common indoor unit drainage piping system can be installed, both incorporating PVC piping.

Table 187: Indoor Unit Drain Piping Specifications.

Indoor Unit	Drain Type	Drain Pipe Diameter (OD / ID, in.)	Drain Amount (gal. / min. at 0.033 ft. height)
Art Cool Wall-Mounted	Gravity	13/16 / 5/8	—
Art Cool Gallery	Gravity	13/16 / 5/8	—
Standard Wall-Mounted	Gravity	13/16 / 5/8	—
Ceiling-Concealed Ducted (Low Static and High Static)	27-1/2 in. Lift Drain Pump, Factory Installed	Ø1-1/4 / Ø1	0.105
Four-Way Ceiling Cassette	27-1/2 in. Lift Drain Pump, Factory Installed	Ø1-1/4 / Ø1	0.105
Vertical-Horizontal Air Handling Unit	Gravity	Ø3/4 / —	—

Figure 82: Diagram of an Indoor Unit with a Gravity Drain.

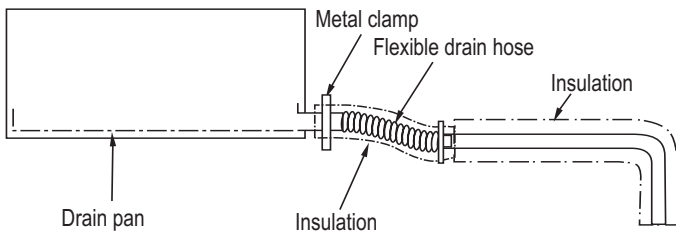
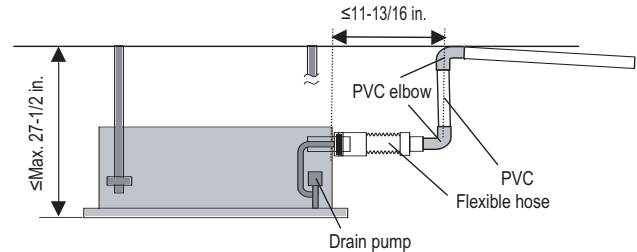

Figure 83: Diagram of an Indoor Unit with a Drain Pump.



#### Note:

Ensure the indoor unit, refrigerant piping, power wiring / communication cables, and drain piping is properly supported with anchor bolts and clamp hangers positioned at 3.3 to 4.9 foot intervals.

#### Flexible Drain Hose

Some indoor units include a factory-provided flexible drain pipe for installation.

- Install the flexible drain pipe as straight as possible; sharp angles may cause the pipe to deteriorate and may crack over time.
- Connect the flexible drain pipe with a round clamp. If the flexible drain pipe is not installed properly, water will leak from the connection.
- Do not include a reverse slope in the drain connection.

Figure 84: Flexible Drain Hose Connection.



Clamp the Flexible Drain Hose Connection

#### Drainage Gradient

The gradient for drain piping should be at least 1/50 to 1/10. Ensure any holes through ceilings, walls, etc., are large enough to accommodate both the drain piping and any insulation.

Figure 85: Drain Piping Gradient Recommendation.

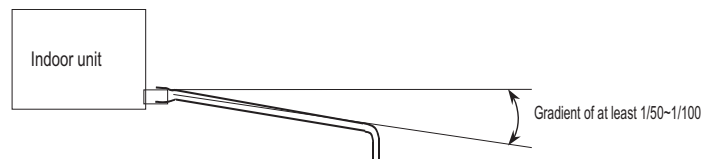

## Condensate Drain Piping

### Common Indoor Unit Drainage System

It is usual work practice to connect individual indoor unit drain pipes to one common indoor unit drainage system. The diameter of the common vertical drain pipe should be as large as necessary. (For systems with <80,000 Btu/h total capacity of all connected indoor units, the standard size for the common vertical drain pipe is 0.98 ID, in. and 1.26 OD, in.) The diameter of the horizontal pipe should be the same or larger than the vertical drain pipe. To avoid property damage in the event of the primary drain becoming clogged, and to optimize drain system performance, it may be prudent to install a secondary drain line. Design the drain system to plan for winter operation (condensate line may freeze up if condensate does not properly drain away). Drain all generated condensate from the external condensate pan to an appropriate area. Install a trap in the condensate lines as near to the indoor unit coil as possible; to prevent overflow the outlet of each trap should be positioned below its connection to the condensate pan. All traps should be primed, insulated, and leak tested if located above an inhabited space.

Figure 86: Example of a Common Indoor Unit Drainage System.

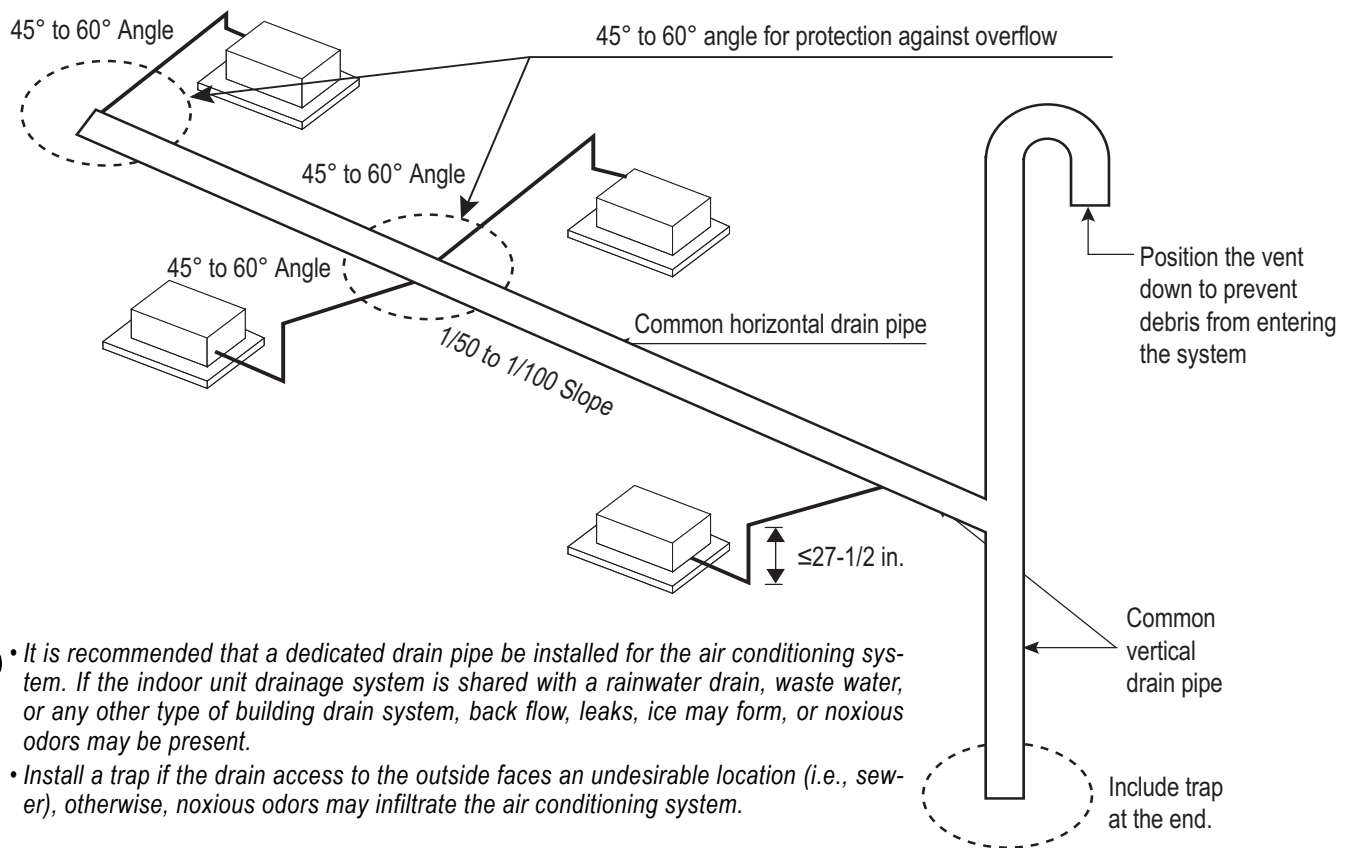

- It is recommended that a dedicated drain pipe be installed for the air conditioning system. If the indoor unit drainage system is shared with a rainwater drain, waste water, or any other type of building drain system, back flow, leaks, ice may form, or noxious odors may be present.
- Install a trap if the drain access to the outside faces an undesirable location (i.e., sewer), otherwise, noxious odors may infiltrate the air conditioning system.

### Drain Leak Test

A leak test should be performed 24 hours after the drainage system has been installed. Only use water for the test; other liquids are unacceptable.

### Drain Pipe Insulation

To prevent condensate from forming on the drain piping, install field-supplied 0.4 inch thick polyethylene. The insulation should be securely fastened with all connected joints and ends properly covered.

Figure 87: Properly Insulating the Drainage Piping.

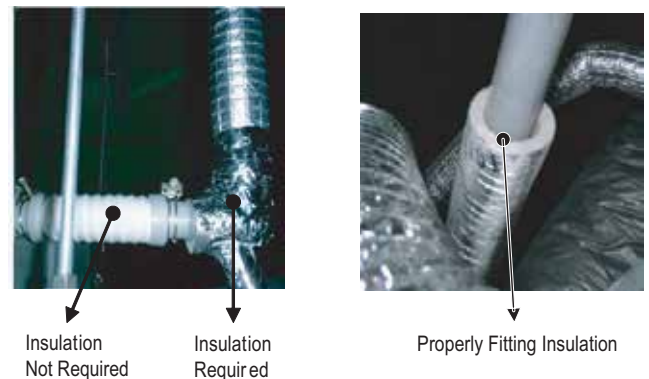

- LG Y-Branch Kit PMBL5620 is required when installing two branch distribution units in parallel on one LG Multi F MAX system.
- The kit must be properly installed following instructions in the applicable LG manual. Field-supplied branch fittings are not permitted.
- Kit components must be kept free of debris and be dry before installation.
- All Y-Branch Kits include a clam shell, peel-and-stick insulation jacket.



Table 188: Fitting Properties.

Material	Copper
Design Pressure	551 psig

Table 189: Multi F MAX Y-Branch Connection Diameters.

Model	Y-Branch Type	Port Identifier (inch)		
		1	2	3
PMBL5620	Liquid	Ø3/8	Ø3/8	Ø3/8
	Vapor	Ø3/4	Ø3/4	Ø3/4
	Y-Branch Type	Dimensions (inch)		
		X	Y	
	Liquid	13.80	3.24	
	Vapor	12.48	3.02	

Figure 88: Y-Branch Port Identifier Diagram.

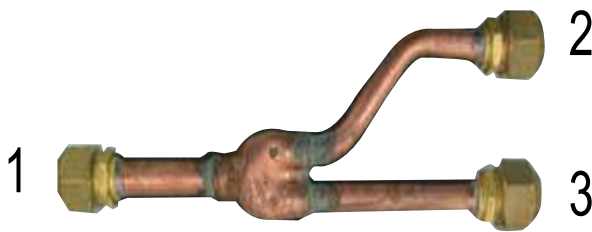

Figure 89: Y-Branch Dimensions Diagram.

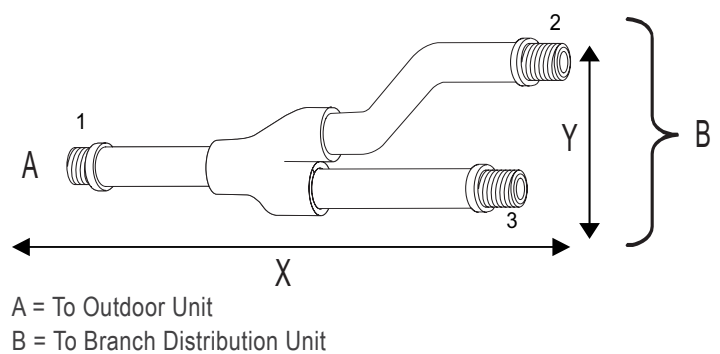
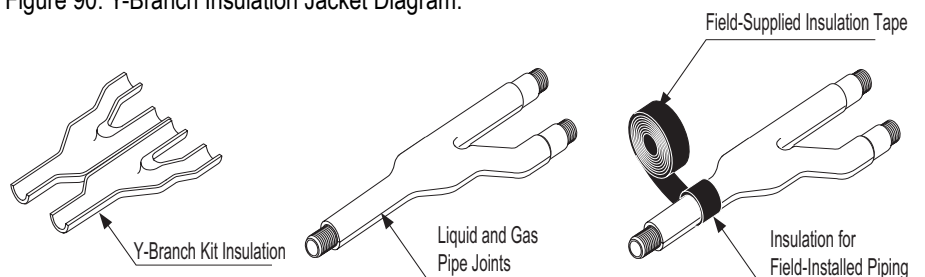

Table 190: Insulation Jacket Properties.

Material	Polyolefin Foam
UL94 Flame Classification	HF-1
Density	1.84 lbs./ft. <sup>3</sup>
Thermal Conductivity	.0208 Btu/h/ft. °R
Thickness	1/2 inch

Figure 90: Y-Branch Insulation Jacket Diagram.





# WIRING CONNECTIONS

**“General Information” on page 220**

**“Power Wiring (208-230V) and Communications Cable  
Details” on page 223**

**“Indoor Unit Group Control” on page 228**

### ⚠ WARNING

- Only qualified technicians—in accordance with federal, state, and local codes, and manufacturer product diagrams and requirements—should install the power wiring and communication cables.
- Use only copper wiring that is stranded, shielded with the wires separately insulated.
- Do not use a multi-conductor cable with more than five (5) wires in one (1) core.
- Power wiring and communications cable sizes must comply with applicable federal UL / ETL, state, and local codes.
- Verify that the branch switch and circuit breaker are set to OFF before installing the wiring system.
- Do not operate the air conditioning system until the refrigerant piping installation is complete. Operating the system before refrigerant piping is finalized may damage the compressor.
- Install a ground wire for the outdoor units, indoor units, and branch distribution units.
- Install a main shutoff switch or circuit breaker that interrupts all power sources simultaneously (circuit breaker should be resistant to electromagnetic currents).
- To avoid the possibility of explosion, fire, etc., do not connect the ground wiring to gas or sewage pipes, lightning rods, and telephone wires. Use clamps to prevent the wires from touching the piping.
- Use ring terminals to attach the wiring. Verify that all power wiring and communications cable terminals are securely attached; ensure enough slack is included in the wiring and cables to avoid damaging the connections.
- Use a conduit to protect the power wiring.
- Do not install a phase-advancing capacitor; the outdoor unit may overheat.

## Power Wiring and Communications Cable Installation

For both Multi F and Multi F MAX systems, power is wired to the outdoor unit only. The outdoor unit will supply power to the branch distribution units (Multi F MAX systems only) and the indoor units through the power wiring / communications cable.

### Electrical Specifications

1. Multi F and Multi F MAX Outdoor Units: 1Ø, 208-230V, 60Hz
2. Indoor units / Branch Distribution Units (Multi F MAX systems only): 1Ø, 208-230V, 60Hz from the outdoor unit (Indoor units draw minimal power.)
3. Power supply wire type and size should be selected based on NEC and local codes. Maximum allowable voltage fluctuation  $\pm 10\%$  of the nameplate rated value.
4. Properly ground the outdoor unit per NEC and / or local code.
5. Use only copper wiring that is stranded and shielded with the wires separately insulated.

### Power Wiring / Communications Cable Specifications

- From Multi F Outdoor Units to Indoor Units = 4 x 18AWG
- From Multi F MAX Outdoor Units to Branch Distribution Units = 4 x 16AWG
- From Multi F MAX Branch Distribution Units to Indoor Units = 4 x 18AWG
- Maximum Allowable Temperature: 194°F
- Multi F System Maximum Cable Length: 88.6 ft.
- Multi F MAX System Maximum Cable Length:
  - Outdoor Unit to Branch Distribution Unit(s): 180.4 ft.
  - Branch Distribution Unit(s) to Indoor Unit(s): 49.2 ft.
- Indoor Unit(s) to Wired Controller: Three-core cable

Figure 91: Power Wiring to Multi F and Multi F MAX ODU.

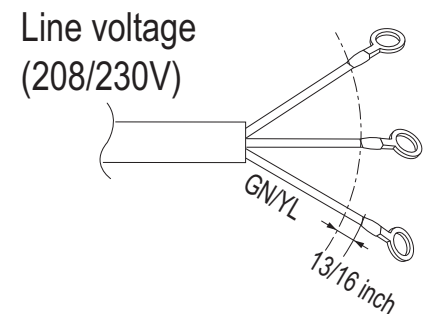
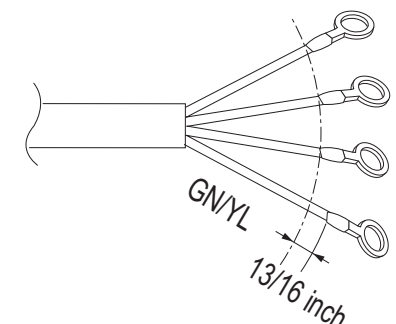

Figure 92: Power Wiring and Communications Cable from the Multi F ODU to the IDUs, or from the Multi F MAX ODU to the BDUs and from the BD Unit to the IDUs.



## Connecting the Power Wiring / Communications Cable

Best practice dictates using ring or spade terminals to terminate power wiring at the power terminal block. If ring terminals or spade clips are not available, then:

- Do not terminate different gauge wires to the power terminal block. (Slack in the wiring may generate heat.)
- When terminating wires of the same thickness, follow the instructions demonstrated in the figures below.
- Firmly attach the wire; secure in a way to prevent external forces from being imparted on the terminal block.
- Use an appropriately sized screwdriver for tightening the terminals.
- Do not overtighten the connections; overtightening may damage the terminals.

Figure 93: Close up of a Typical Ring Terminal.

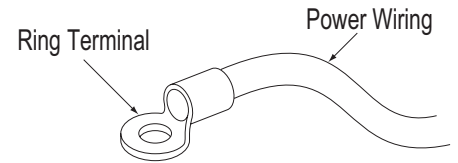

Figure 94: Close up of the Indoor Unit Terminal Block.

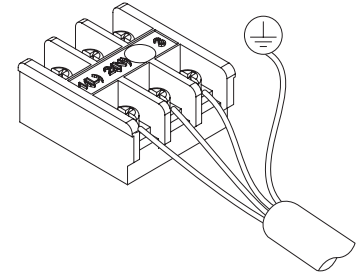
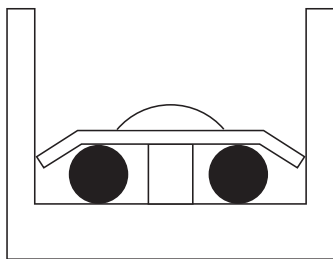
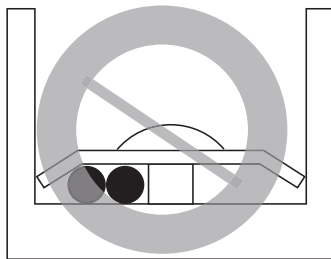

Figure 95: Proper and Improper Power Wiring Connections.



Terminate multiple power wires of the same gauge to both sides.



Do not terminate two wires on one side.

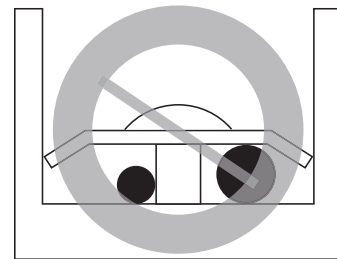

Do not terminate different gauge wires to a terminal block.

● :Copper Wire

### ⚠ WARNING

*If power wires are not properly terminated and firmly attached, there is risk of fire, electric shock, and physical injury or death.*

### Note:

- Never apply line voltage power to the communications cable terminal block. If contact is made, the PCBs may be damaged.
- Always include some allowance in the wiring length when terminating. Provide some slack to facilitate removing the electrical panels while servicing.

# WIRING CONNECTIONS

## General Information

MULTI F  
MULTI F MAX

Figure 96: Multi F System General Power / Communications System Schematic.

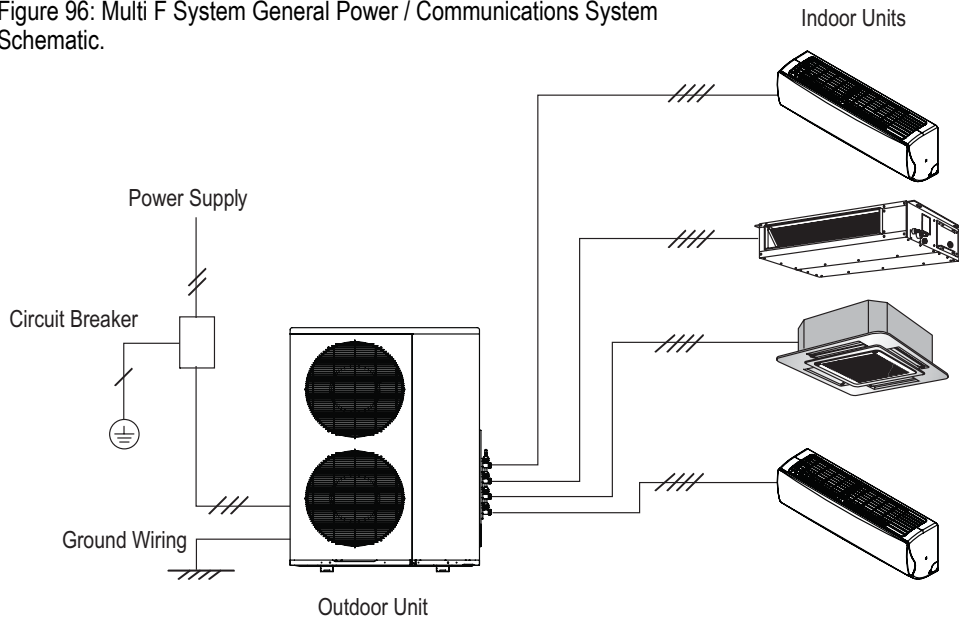
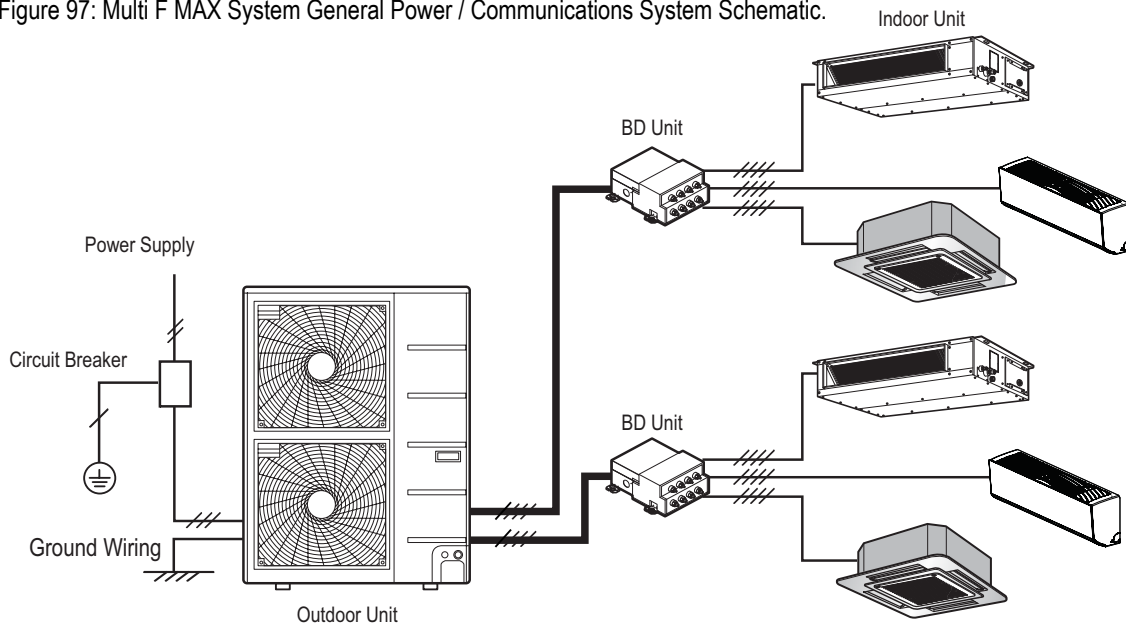

Figure 97: Multi F MAX System General Power / Communications System Schematic.



### Note:

- Secure the separate wires in the control box panel using zip ties.
- Secure wiring with accessory clamps so that it does not touch piping.
- Use a conduit for the cable
- Outside the unit, make sure the communications cable and the power wiring are separately shielded, otherwise, the outdoor unit operation may be affected by electrical noise and will malfunction or fail.

- Find the outdoor unit terminal block by unscrewing the control access panel.
- Side panel of the outdoor unit has knockout holes for the conduits. After install is complete, seal up any gaps between the panel and the conduits.
- Clamp is included near the terminal block to help protect the connections from strain on the cables.

### ⚠ WARNING

- Always have a trained technician properly ground the outdoor unit. If the outdoor unit is not properly grounded, there is a risk of electric shock.
- Use a conduit for the power wiring.
- The communications cable should be separated and isolated from the outdoor unit power wiring, computers, radio and television broadcasting facilities, as well as medical imaging equipment.

Figure 98: Example of Power Wiring and Communications Cable Terminations.

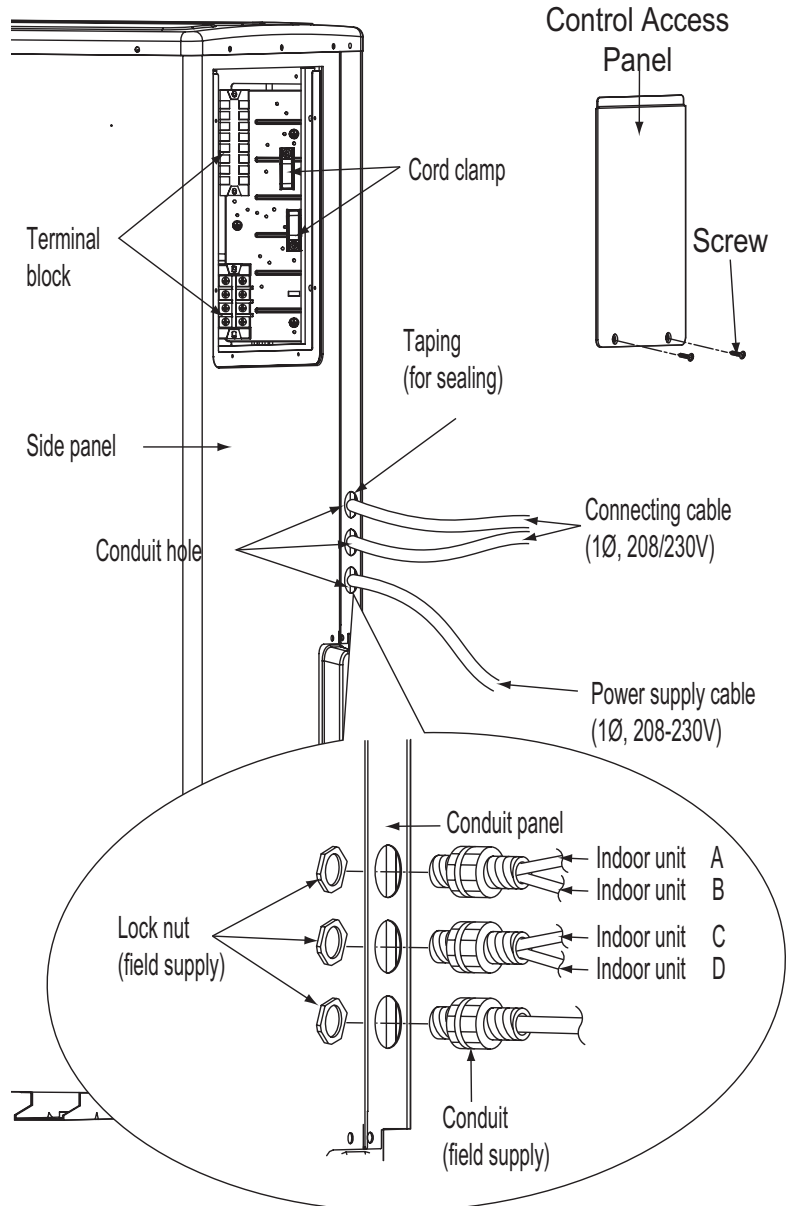

# WIRING CONNECTIONS

Power Wiring (208-230V) and Communications Cable Details

MULTI F  
MULTI F MAX

Figure 99: Multi F LMU187HV System Power Wiring and Communications Cable.

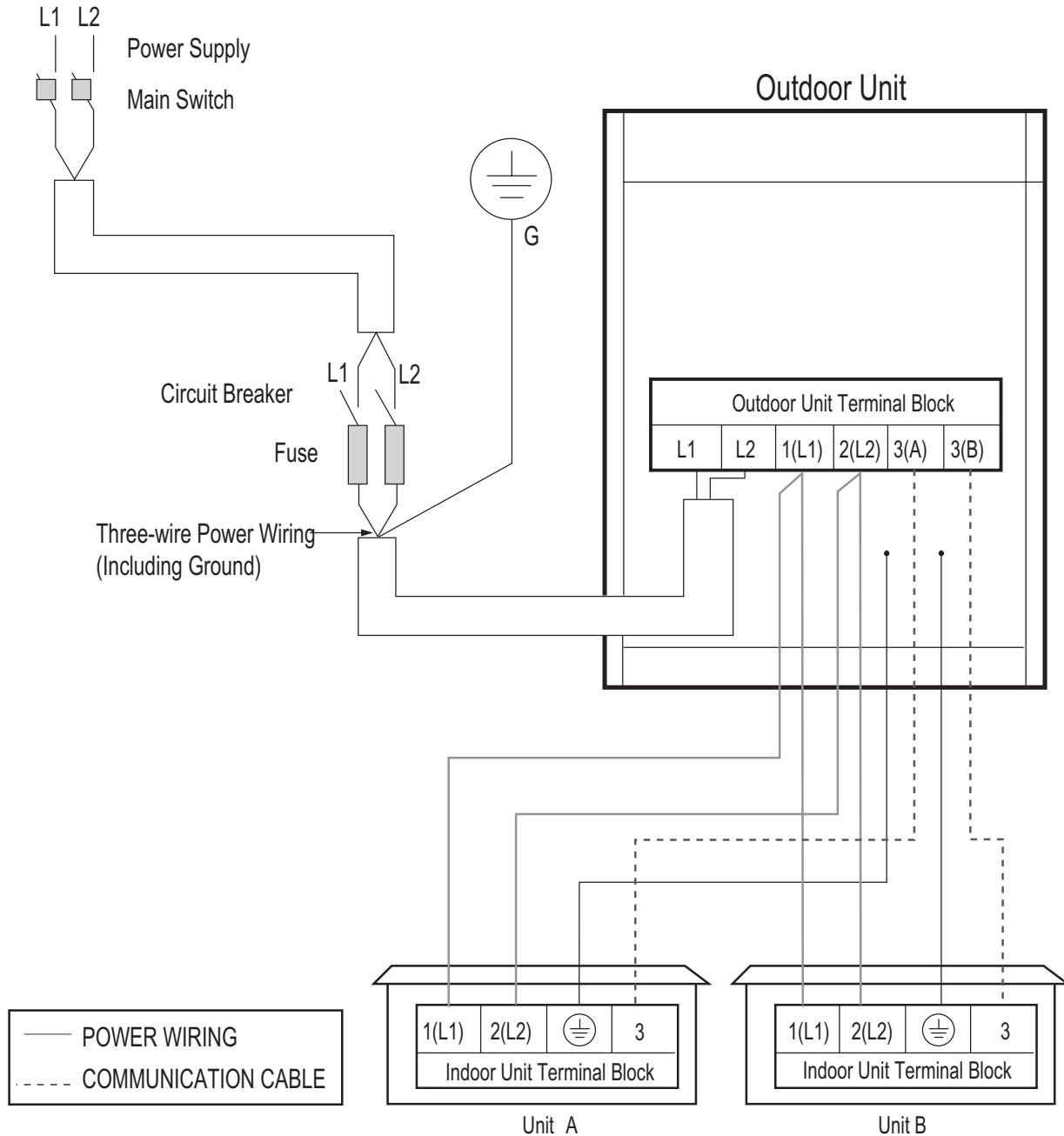

## ⚠️ WARNING

- All field-supplied wiring, components, and materials should follow national, state, and local codes and requirements.
- Use only stranded, shielded copper conductor.
- Ground wiring is required to prevent accidental electrical shock during current leakage, communication problems from electrical noise, and motor current leakage. Do not connect the ground line to the pipes.
- Install a main shutoff switch or circuit breaker that interrupts all power sources simultaneously.
- Wiring cable size must comply with applicable national, state, and local codes.

Figure 100: Multi F LMU247HV System Power Wiring and Communications Cable.

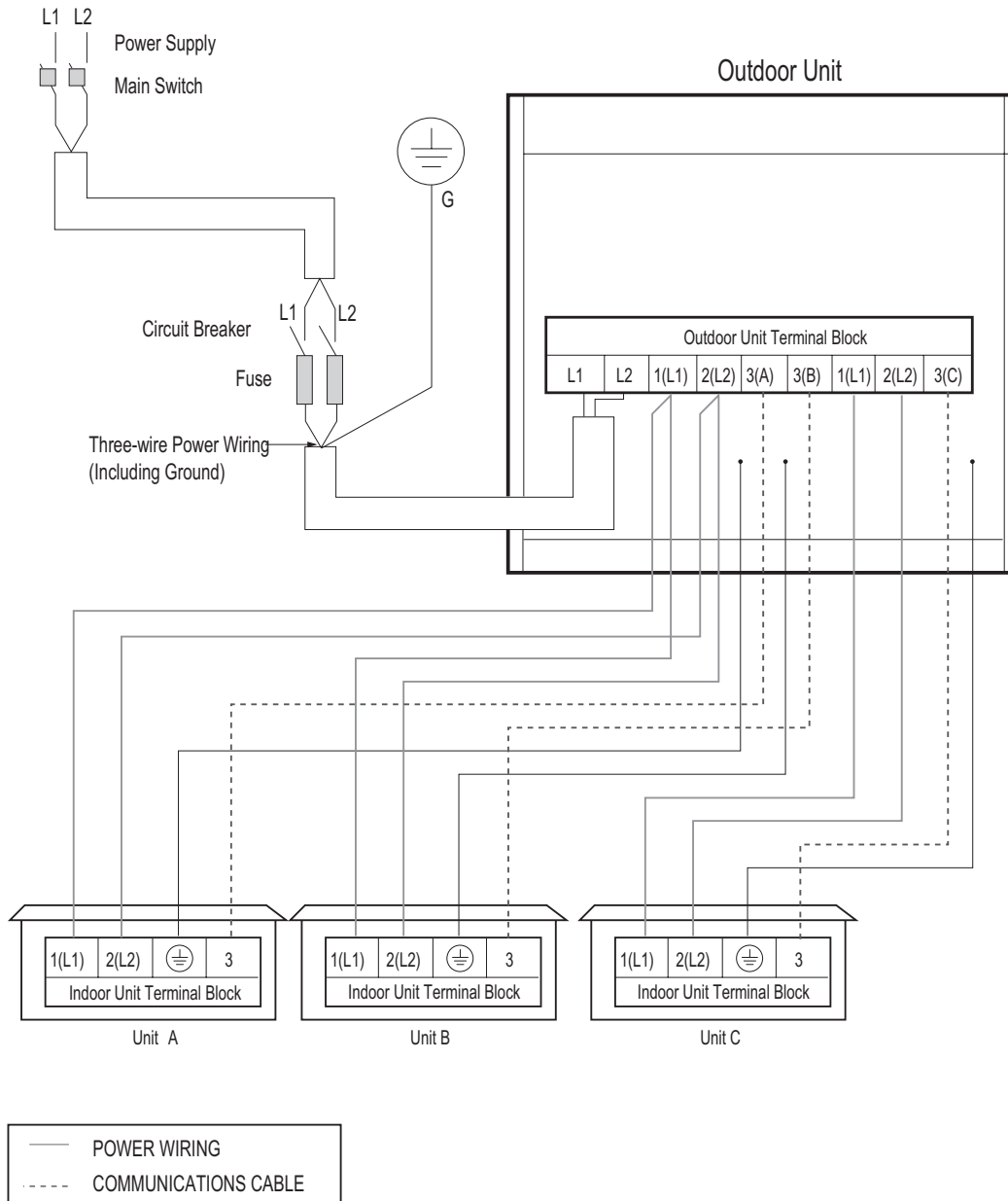

**⚠ WARNING**

- All field-supplied wiring, components, and materials should follow national, state, and local codes and requirements.
- Use only stranded, shielded copper conductor.
- Ground wiring is required to prevent accidental electrical shock during current leakage, communication problems from electrical noise, and motor current leakage. Do not connect the ground line to the pipes.
- Install a main shutoff switch or circuit breaker that interrupts all power sources simultaneously.
- Wiring cable size must comply with applicable national, state, and local codes.

# WIRING CONNECTIONS

## Power Wiring (208-230V) and Communications Cable Details

MULTI F  
MULTI F MAX

Figure 101: Multi F LMU369HV System Power Wiring and Communications Cable.

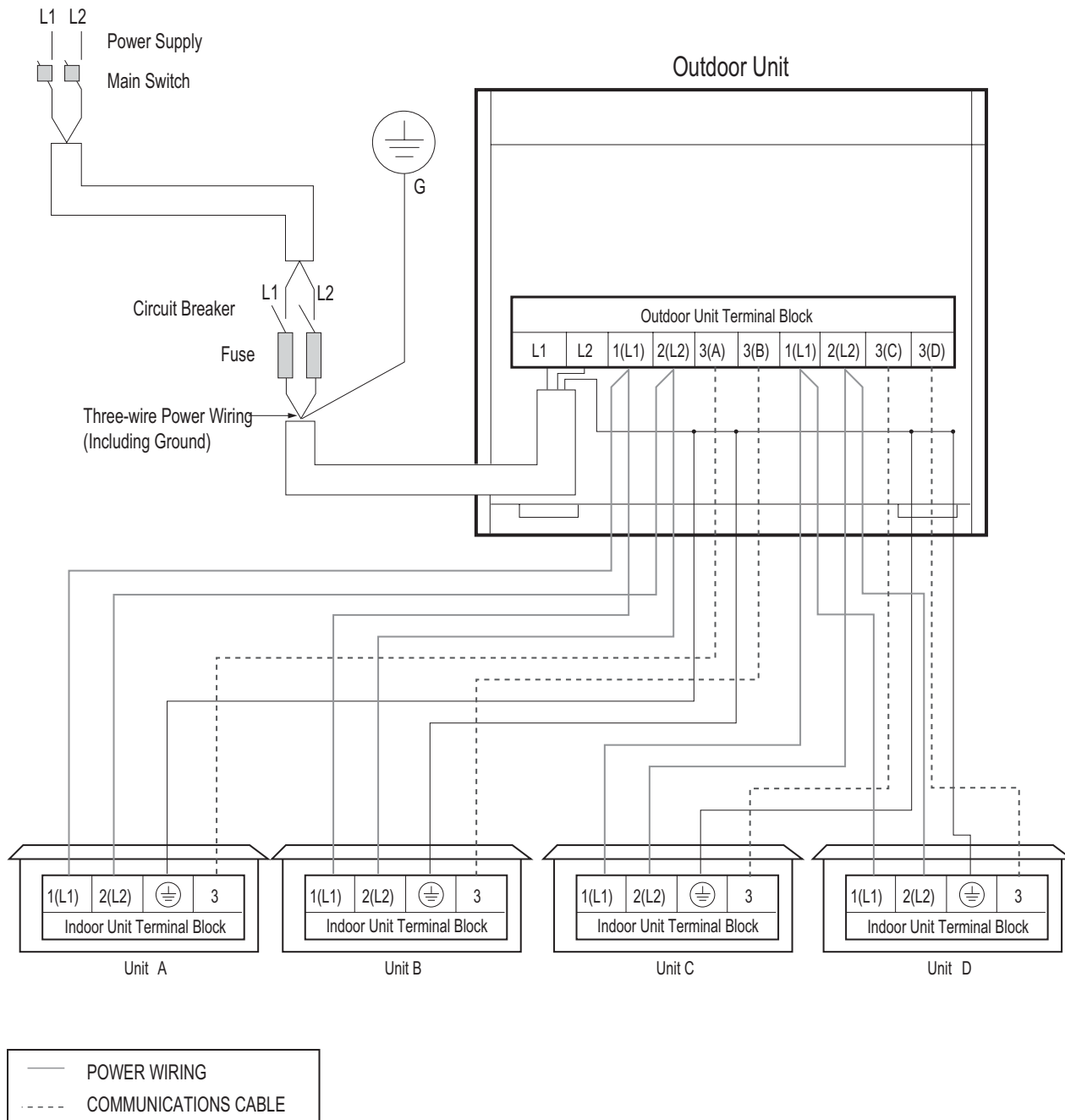

### ⚠ WARNING

- All field-supplied wiring, components, and materials should follow national, state, and local codes and requirements.
- Use only stranded, shielded copper conductor.
- Ground wiring is required to prevent accidental electrical shock during current leakage, communication problems from electrical noise, and motor current leakage. Do not connect the ground line to the pipes.
- Install a main shutoff switch or circuit breaker that interrupts all power sources simultaneously.
- Wiring cable size must comply with applicable national, state, and local codes.

Figure 102: Multi F MAX LMU540HV System Power Wiring and Communications Cable.

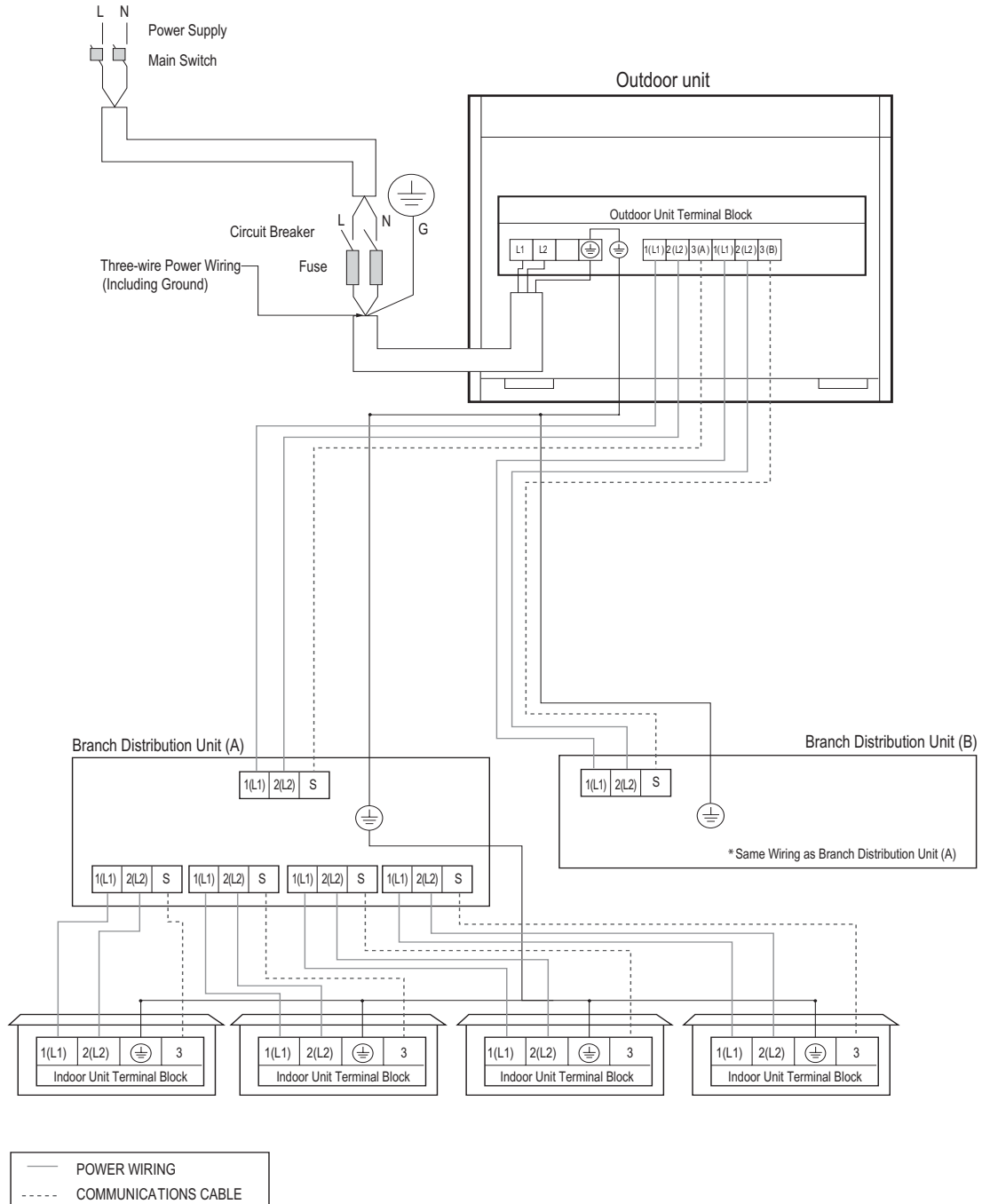

**⚠ WARNING**

- All field-supplied wiring, components, and materials should follow national, state, and local codes and requirements.
- Use only stranded, shielded copper conductor.
- Ground wiring is required to prevent accidental electrical shock during current leakage, communication problems from electrical noise, and motor current leakage. Do not connect the ground line to the pipes.
- Install a main shutoff switch or circuit breaker that interrupts all power sources simultaneously.
- Wiring cable size must comply with applicable national, state, and local codes.

### Communication Cables Between Multiple Indoor Units Operating as a Group (Group Control)

1. If any indoor units were specified to operate in unison, use one (or multiple) three-core Group Control Kit (sold separately) containing extension and Y-splitter cables. One (1) group control cable kit for each indoor unit in the group except for the last indoor unit.
2. Always use an LG provided group control communications cable (Group Control Kit; sold separately) between the indoor unit and the wall-mounted zone controller.
3. NEVER splice, cut, or extend cable length with field provided cable.
4. A maximum of 16 indoor units can be connected to a wired remote controller (maximum wire length: 164 feet). Before running cable, decide which indoor unit will be the "Master;" set the remaining as "Slave." The zone controller will be connected to the "Master."
5. Identify each indoor unit operating as a group as "Master" or "Slave". Adjust the pertinent DIP switch at each indoor unit. On wall mounted indoor unit models, set the assignment using the handheld remote controller.
6. Use a daisy chain configuration and connect all of the group's indoor units together starting at the "Master" unit.

#### General Specifications

- Wired remote controllers can be connected to all indoor unit types.
- Wireless handheld controllers can be used in conjunction with wired remote controllers.
- A dry contact unit can be connected with a central controller simultaneously.
  - The master indoor unit is recognized by the dry contact unit and the central controller.
  - Group Control only available for indoor units manufactured after February 2009.
  - The central controller can control indoor units after setting the address of the master indoor unit only.
  - Slave indoor unit cannot be individually controlled by central controller.
  - Slave indoor unit will operate like master indoor unit.
- If an error occurs with the indoor unit, the error will be displayed on the wired remote controller.
- The following functions are available with group control:
  - Selection of operation options (operation/mode/set temperature)
  - Control of air flow rate (High/Medium/Low)

Figure 103: Indoor Unit Group to Zone Controller Connections.

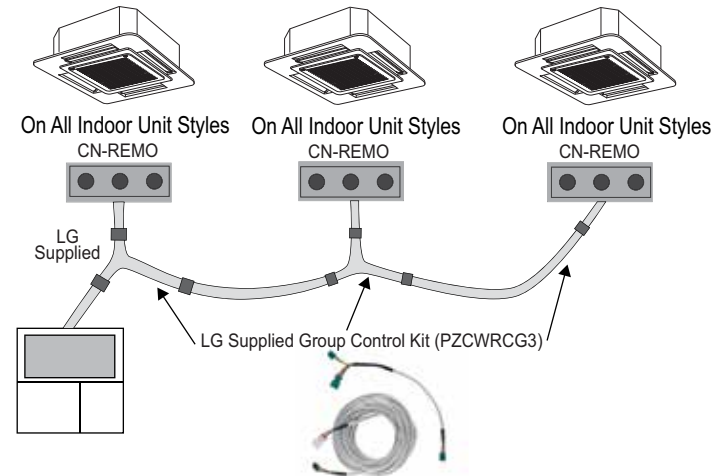

#### Note:

Cable connected to Zone Controller is the factory default connection.

Table 191: Accessories Required for Group Control.

Accessory	Model Number	Image
Wired Remote Group Control Cable Assembly - Required for connecting multiple indoor units to a control group	PZCWRCG3	
Wired Remote/Wired Remote Extension Cable - Required for extending the distance between indoor units or remote controllers in a control group	PZCWRC1	

Table 192: Table of Acronyms.

ABS	Acrylonitrile Butadiene Styrene	IAQ	Indoor Air Quality
AC	Air Conditioner	IDU	Indoor Unit
ACP	Advanced Control Platform	IUCF	Indoor Unit Correction Factor
ARI	Air Conditioning and Refrigeration Institute	KTL	Korea Testing Laboratories
ASHRAE	American Society of Heating, Refrigeration, and Air Conditioning	LATS	LG Air Conditioning Technical Solution
AWG	American Wire Gauge	LGAP	LG Air Conditioner Protocol
BDU	Branch Distribution (Unit)	MAT	Mixed Air Temperature
Btu/h	British Thermal Units per hour	MBh	Thousands BTUs per hour
CCR	Corrected Capacity Ratio	MCA	Maximum Circuit Ampacity
CDOA	Coupled Dedicated Outdoor Air	MFS	Maximum Fuse Size
CFM	Cubic Feet per Minute	NEC	National Electrical Code
CR	Combination Ratio	OAT	Outdoor Air Temperature
DB	Dry Bulb	ODU	Outdoor Unit
dB(A)	Decibels with "A" frequency weighting	OUCF	Outdoor Unit Correction Factor
DDOAS	Decoupled Dedicated Outdoor Air	PDI	Power Distribution Indicator
DFS	Duct-Free Split	PI	Power Input
DI	Digital Input	PTAC	Packaged Terminal Air Conditioner
DO	Digital Output	PVE	Polyvinyl Ether
EEV	Electronic Expansion Valve	RAT	Return Air Temperature
ELF	Equivalent Length in Feet	RCL	Refrigerant Concentration Limit
EPDM	Ethylene Propylene Diene M-Class Rubber	SC	Sensible Capacity
ESP	External Static Pressure	TC	Total Capacity
ETL	Electronic Testing Laboratories	VAV	Variable Air Volume
HACR	Heating, Air Conditioning, and Refrigeration	VRF	Variable Refrigerant Flow
H/M/L	High / Medium / Low	VRP	Ventilation Rate Procedure





*Inverter*

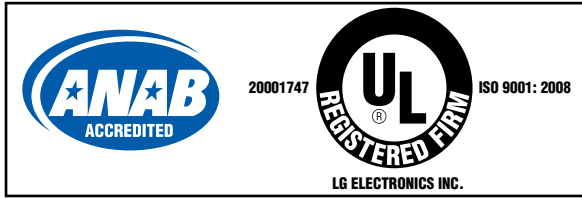

LG Electronics  
Commercial Air Conditioning Division  
11405 Old Roswell Road  
Alpharetta, Georgia 30009  
www.lg-dfs.com

LG Electronics Products Support  
1-888-865-3026 USA  
Follow the prompts for HVAC products.

DFS-EM-AJ-001-US 014C25  
Supersedes DFS-EM-AJ-001-US 014A03  
Supersedes DFS-EM-AJ-001-US 013M09  
Supersedes DFS-EM-AJ-001-US 013K30



OWNER'S MANUAL

# AIR CONDITIONER

---

Read the IMPORTANT SAFETY INSTRUCTIONS completely first.

In order to use the product safely and conveniently, please read the owner's manual before using the product.

ENGLISH FRANÇAIS ESPAÑOL

TYPE: WALL MOUNTED

K\*UAB\*\*1A, K\*UAK\*\*1A, KNMAB\*\*1A



MFL69491110  
Rev.01\_100824

[www.lghvac.com](http://www.lghvac.com)  
[www.lg.com](http://www.lg.com)

Copyright © 2024 LG Electronics. All Rights Reserved

## TABLE OF CONTENTS

### 3 OPERATION

---

- 3 SEE MORE INFORMATION
- 3 Installing LG ThinQ Application and Connecting an LG Appliance (On Some Models)
- 4 WIRELESS REMOTE CONTROL
- 7 NEW FUNCTIONS
- 9 HELPFUL TIP

### 9 PRODUCT OVERVIEWS

---

- 9 Wall Mounted

### 10 MAINTENANCE

---

- 10 Removing and Replacing the Air Filter
- 11 Cleaning the Air Filter

### 12 TROUBLESHOOTING

---

- 12 Before Calling for Service

### 14 APPENDIX

---

- 14 Open Source Software Notice Information

### 15 LIMITED WARRANTY

---

- 15 USA
- 17 CANADA

# OPERATION

## SEE MORE INFORMATION

- 1 Check the model name on the label.

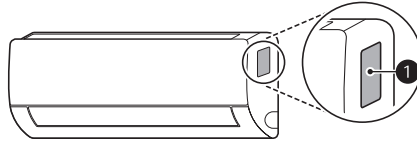

- 1 Label

- 2 Search for the model name at [www.lg.com](http://www.lg.com).

### NOTE

- The image may differ depending on the product.

## Installing LG ThinQ Application and Connecting an LG Appliance (On Some Models)

### NOTE

- This feature is only available on models with Wi-Fi.

### Models with QR Code

Scan the QR code attached to the product using the camera or a QR code reader application on your smartphone.

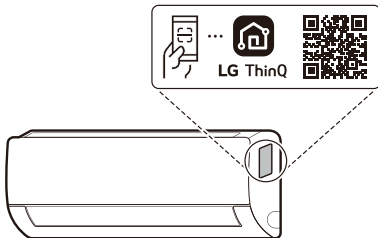

### Models without QR Code

Search for and install the **LG ThinQ** application from the Google Play Store or Apple App Store on a smartphone.

Run the **LG ThinQ** application and sign in with your existing account or create an LG account to sign in.

Touch the add (+) button on the **LG ThinQ** application to connect your LG appliance. Follow the instructions in the application to complete the process.

## 4 OPERATION





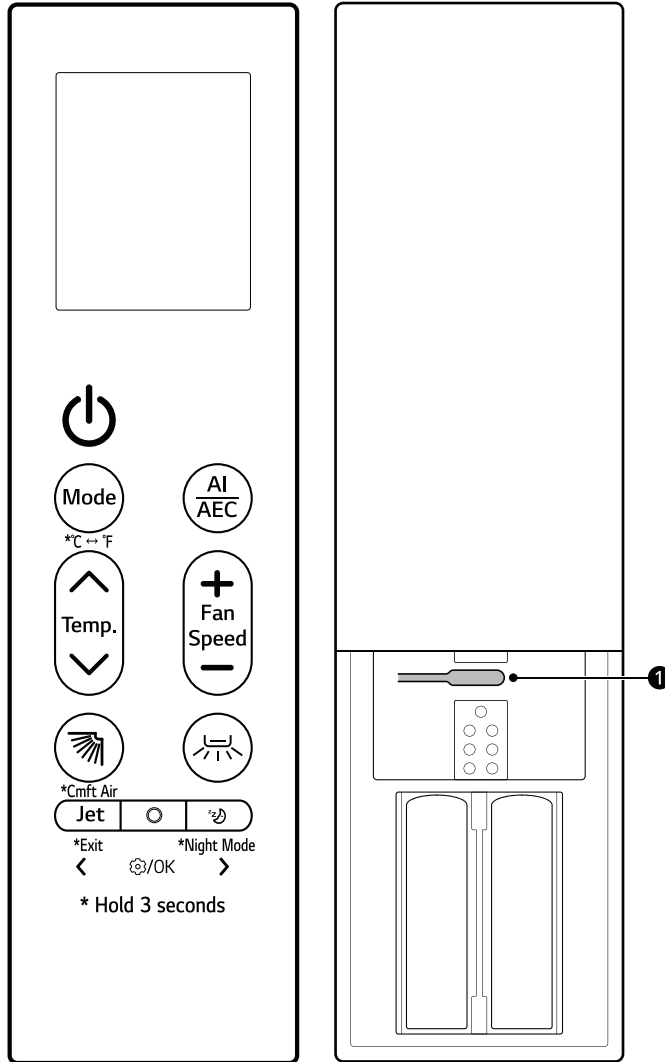

### WIRELESS REMOTE CONTROL

You can operate the appliance more conveniently with the wireless remote control.  
For more detailed instructions, please refer to the Web-manual.



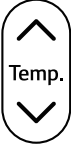





#### NOTE

- Some functions may not be supported, depending on the model.

Image	Description
	<p><b>Power</b> Turns the appliance on or off.</p>
	<p><b>Connecting to LG ThinQ</b> Press and hold the <b>Power</b> button for about 3 seconds to prepare for connecting appliance and Wi-Fi.</p>
	<p><b>Mode</b> Selects the desired operating mode.</p> <ul style="list-style-type: none"> <li>Each press changes the mode in this order: <b>Cooling</b> → <b>Auto</b> → <b>Dehumidification</b> → <b>Heating</b> → <b>Fan</b></li> </ul> <p>°C ↔ °F</p> <p>Press and hold the <b>Mode</b> button for about 3 seconds to change units between °C and °F</p>
	<p><b>AI/AEC</b> Selects <b>AI Smart Care</b> or <b>Active Energy Control</b> to decrease the power input.</p> <p><b>NOTE</b></p> <ul style="list-style-type: none"> <li>When connected to the Multi Outdoor unit, <b>Active Energy Control</b> function may not be supported.</li> </ul>
	<p><b>Temperature ^, v</b> Adjusts the desired room temperature.</p>
	<p><b>Fan Speed +, -</b> Adjusts the fan speed.</p>
	<p><b>(Up-Down Swing)</b> Adjusts the airflow direction up and down.</p> <p><b>Cmft Air</b></p> <p>Press and hold the  button for about 3 seconds to adjust the airflow direction. This will help minimize direct contact with airflow.</p>

## 6 OPERATION

Image	Description
	<b>左右 (Left-Right Swing)</b> Adjusts the airflow direction left and right.
	<b>Jet</b> Changes the room temperature quickly and operates at maximum fan speed. <b>Exit</b> When entering the settings, press and hold the <b>Jet</b> button for about 3 seconds to return the previous setting.
	<b>Function</b> Selects the desired function. <b>NOTE</b> <ul style="list-style-type: none"><li>When connected to the Multi Outdoor unit, <b>Low Ambient Heating</b> function may not be supported.</li></ul>
	<b>睡眠 (Sleep)</b> Automatically turns the appliance off at a desired time. Use it before sleeping. <b>Night Mode</b> Press and hold the  button for about 3 seconds to turn off the display and the beep sound.
	<b>1 Reset</b> Resets the wireless remote control setting.

## NEW FUNCTIONS

### All Cleaning (On Some Models/LG ThinQ)

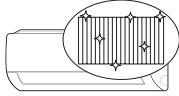

By repeatedly freezing and thawing the heat exchanger of the air conditioner, contaminants such as dust are washed away and the appliance is kept clean.

After cleaning, it reduces moisture inside the indoor unit.

On some indoor units, RL appears on the display of the indoor unit.

#### NOTE

- The **All Cleaning** function will end after the appliance has dried.
- If the humidity in the room is high when the **All Cleaning** function is operating, the area near the indoor unit may become foggy.
- The **All Cleaning** function can be used indoors at 70 °F (21 °C) to 90 °F (32 °C) and outdoors at 70 °F (21 °C) to 99 °F (37 °C). The **All Cleaning** function is a hygiene management function, not a cooling function, so the usage conditions may vary from the verified operation range of the appliance.
- If the **All Cleaning** function is operated at a temperature outside of the allowable range, alarms in the **LG ThinQ** application and the function does not work.
- The **All Cleaning** function is available even when the appliance is running.
- If you press the  button on the appliance or on the remote control during the **All Cleaning**, the **All Cleaning** function is deactivated.
- During the **All Cleaning**, a “tick-tick-” or “tack-tack” noise may be heard as the appliance expands or contracts.
- After the **All Cleaning**, the appliance will automatically shut off. When the power is turned back on, it will operate in **Cooling** mode.
- If the **Timer** function is set, the **All Cleaning** function may not operate properly.
- Cool air comes out of the outlet when the **All Cleaning** function is activated.
- When connected to the Multi Outdoor unit, this functions may not be supported.

### kW Manager (On Some Models/LG ThinQ)

The air conditioner power consumption is automatically adjusted based on a schedule and target power consumption set by the user.

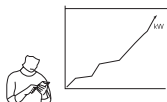

Ⓚ appears on the display of the indoor unit on some models.

#### NOTE

- When using **kW Manager** function, the output of cold air may be reduced, depending on the remaining target power amount.
- When the target electricity consumption is exceeded, the **kW Manager** function is disabled.
- When using the **Heating** and **Auto** modes, the **kW Manager** function is disabled.
- When connected to the Multi Outdoor unit, this functions may not be supported.
- The power usage shown through the **LG ThinQ** application may differ from the actual power usage shown on your utility bill.
- Power consumption information may vary depending on the appliance.
- Power consumption may differ from results measured using other measuring devices.
- Depending on the environment in which the device is installed, measured power consumption may vary.
- Measured power consumption may vary depending on the usage environment or usage method of the home appliance.
- When setting the usage time, the appliance does not automatically turn on or off.
- Even during the operation of the **kW Manager** function, the function set with the remote control is reflected first.
- Actual usage may differ.

### Sleep+ (On Some Models/LG ThinQ)



Use it before sleeping. The appliance will automatically learn and adjust the temperature and fan speed to create an even more personalized sleep environment.

#### NOTE

- This function can be set when the appliance is turned on.
- This function is available with the **Cooling** mode.
- When connected to the Multi Outdoor unit, this functions may not be supported.

## HELPFUL TIP

### Manual Operation

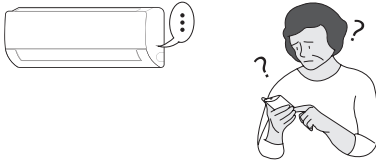

If your wireless remote control is unavailable, you can turn the appliance on and off by pressing the **POWER** button ① on the indoor unit.

- 1 Open the up-down vane.
- 2 Press the **POWER** button ①.

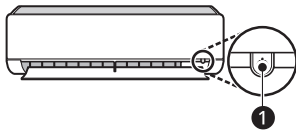

## PRODUCT OVERVIEWS

### Wall Mounted

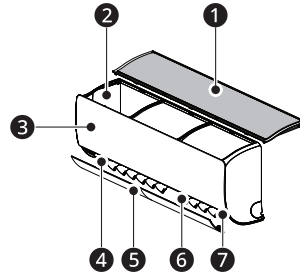

- ① Air Filter
- ② Air Intake Vents
- ③ Front Cover
- ④ Air Outlet Vents
- ⑤ Air Deflector (Up-Down Vane)
- ⑥ Air Deflector (Left-Right Louver)
- ⑦ Power Button

### NOTE

- The number and location of parts may vary depending on the model of the appliance.
- Features may change depending on the model type.

# MAINTENANCE

## Removing and Replacing the Air Filter

- 1 Turn off the power to the appliance.
- 2 Locate the knobs of the air filter on the top front of the appliance.

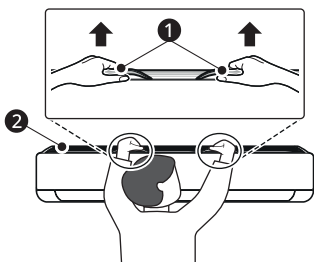

- 1 Knobs
- 2 Air Filter

- 3 Pull the knobs upward slightly and then lift the entire filter to remove it.

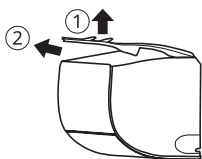

- 4 Insert the hooks on the air filter into the slots on the back of the front panel.

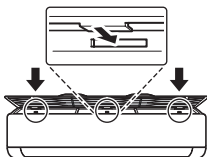

- 5 Push the hooks down until they click into place.

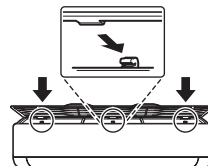

- 6 To make sure the filter is assembled properly, press down along the entire front length of the filter.

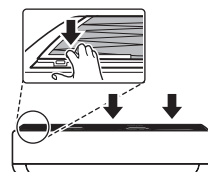

## Cleaning the Air Filter

- 1 Remove the air filter from the appliance.
- 2 Clean the air filter with a vacuum cleaner or wash it with lukewarm water and a mild detergent.

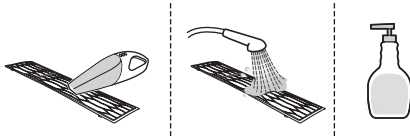

- 3 Dry the filter in the shade.

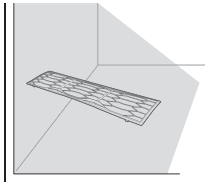

### NOTE

- Clean the air filter once every 2 weeks, or more if needed.
- Do not bend the air filter, as it may break.
- Do not operate the appliance without the filter in place.
- Assemble the air filter properly to prevent dust and other substances from entering the appliance.

# TROUBLESHOOTING

## Before Calling for Service

Please check the following before you contact the service centre. If the problem persists, contact your local service centre.

## Self-Diagnosis Function

This appliance has a built-in **self-diagnosis** function. If an error occurs, the lamp of the indoor unit will flash in 2-second intervals. If this occurs, contact your local dealer or service centre.

### The appliance does not work normally.

- Burning smell and strange sounds are coming from the appliance.
- Water leaks from the indoor unit even when the humidity level is low.
- The power cable is damaged or it is generating excessive heat.
- A switch, a circuit breaker (safety, ground) or a fuse is not operating properly.
- The appliance generates an error code from its self-diagnosis.
  - Turn off the appliance, switch off or disconnect the power supply, and contact the service centre.
- R32 refrigerant leakage detecting system is activated.
  - If there are error code such as 228,229 and 230, ventilate the room and contact authorized personnel immediately.
  - If there is an error code of 236, the refrigerant leak detector has a lifetime of less than 6 months. Contact authorized personnel immediately.

### The fan speed cannot be adjusted.

- The Jet mode or Auto Operation mode is selected.
  - In some operating modes, you cannot adjust the fan speed. Select an operating mode in which you can adjust the fan speed.

### The temperature cannot be adjusted.

- The Fan mode or Jet mode is selected.
  - In some operating modes, you cannot adjust the temperature. Select an operating mode in which you can adjust the temperature.

### The appliance does not work.

- The appliance is unplugged.
  - Check whether the power cord is plugged into the outlet or the power isolators are switched on.
- A fuse exploded or the power supply is blocked.
  - Replace the fuse or check if the circuit breaker has tripped.
- A power failure has occurred.
  - Turn off the appliance when a power failure occurs.
  - When the power is restored, wait 3 minutes, and then turn on the appliance.

- The voltage is too high or too low.
  - Check if the circuit breaker has tripped.
- The appliance was turned off automatically at a preset time.
  - Turn the appliance on.
- The battery setting in the wireless remote control is incorrect.
  - Make sure that the batteries are inserted correctly in your wireless remote control.
  - If the batteries are placed correctly, but the appliance still does not operate, replace the batteries and try again.

#### The appliance does not emit cool air.

- Air is not circulating properly.
  - Make sure that there are no curtains, blinds, or pieces of furniture blocking the front of the appliance.
- The air filter is dirty.
  - Clean the air filter once every 2 weeks.
  - See “**Cleaning the Air Filter**” for more information.
- The room temperature is too high.
  - In summer, cooling the indoor air fully may take some time. In this case, select the **Jet** mode to cool the indoor air quickly.
- Cold air is escaping from the room.
  - Make sure that no cold air is escaping through the ventilation points in the room.
- The desired temperature is higher than the current temperature.
  - Set the desired temperature to a level lower than the current temperature.
- There is a heating source nearby.
  - Avoid using heat generators like electric ovens or gas hobs while the air conditioner is in operation.
- Fan mode is selected.
  - During **Fan** mode, air blows from the appliance without cooling or heating the indoor air.
  - Switch the operating mode to cooling operation.

#### The indoor unit is still operating even when the appliance has been turned off.

- The Auto Clean+ function is being operated.
  - Allow the **Auto Clean+** function to continue since it reduces any remaining moisture inside the indoor unit. If you do not want this function, you can turn the indoor unit off.

#### The appliance does not emit warm air.

- When the Heating mode starts, the vane is almost closed, and no air comes out, even though the outdoor unit is operating.
  - This is normal. Please wait until the appliance has generated enough warm air to blow through the indoor unit.
- The outdoor unit is in Defrosting mode.
  - In **Heating** mode, ice and frost is built up on the coils when the outside temperature falls. The **Defrosting** mode reduces a layer of frost on the coil, and it should finish in approximately 15 minutes.

# APPENDIX

## Open Source Software Notice Information

To obtain the source code that is contained in this product, under GPL, LGPL, MPL, and other open source licenses that have the obligation to disclose source code, and to access all referred license terms, copyright notices and other relevant documents, please visit <https://opensource.lge.com>.

LG Electronics will also provide open source code to you on CD-ROM for a charge covering the cost of performing such distribution (such as the cost of media, shipping, and handling) upon email request to [opensource@lge.com](mailto:opensource@lge.com).

This offer is valid to anyone in receipt of this information for a period of three years after our last shipment of this product.

# LIMITED WARRANTY

## USA

### TERMS AND CONDITIONS

ARBITRATION NOTICE: THIS LIMITED WARRANTY CONTAINS AN ARBITRATION PROVISION THAT REQUIRES YOU AND LG ELECTRONICS (“LG”) TO RESOLVE DISPUTES BY BINDING ARBITRATION INSTEAD OF IN COURT, UNLESS YOU CHOOSE TO OPT OUT. IN ARBITRATION, CLASS ACTIONS AND JURY TRIALS ARE NOT PERMITTED. PLEASE SEE THE SECTION TITLED “PROCEDURE FOR RESOLVING DISPUTES” BELOW.

ENGLISH

### PROCEDURE FOR RESOLVING DISPUTES:

ALL DISPUTES BETWEEN YOU AND LG ARISING OUT OF OR RELATING IN ANY WAY TO THIS LIMITED WARRANTY OR THE PRODUCT SHALL BE RESOLVED EXCLUSIVELY THROUGH BINDING ARBITRATION, AND NOT IN A COURT OF GENERAL JURISDICTION. BINDING ARBITRATION MEANS THAT YOU AND LG ARE EACH WAIVING THE RIGHT TO A JURY TRIAL AND TO BRING OR PARTICIPATE IN A CLASS ACTION.

**Definitions.** For the purposes of this section, references to “LG” mean LG Electronics U.S.A., Inc., its parents, subsidiaries and affiliates, and each of their officers, directors, employees, agents, beneficiaries, predecessors in interest, successors, assigns and suppliers; references to “dispute” or “claim” shall include any dispute, claim or controversy of any kind whatsoever (whether based in contract, tort, statute, regulation, ordinance, fraud, misrepresentation or any other legal or equitable theory) arising out of or relating in any way to the sale, condition or performance of the product or this Limited Warranty.

**Notice of Dispute.** In the event you intend to commence an arbitration proceeding, you must first notify LG in writing at least 30 days in advance of initiating the arbitration by sending a letter to LG at LG Electronics, USA, Inc. Attn: Legal Department-Arbitration 111 Sylvan Avenue, Englewood Cliffs, NJ 07632. You and LG agree to engage in good faith discussions in an attempt to amicably resolve your claim. The notice must provide your name, address, and telephone number; identify the product that is the subject of the claim; and describe the nature of the claim and the relief being sought. If you and LG are unable to resolve the dispute within 30 days, either party may proceed to file a claim for arbitration.

**Agreement to Binding Arbitration and Class Action Waiver.** Upon failure to resolve the dispute during the 30 day period after sending written notice to LG, you and LG agree to resolve any claims between us only by binding arbitration on an individual basis, unless you opt out as provided below. Any dispute between you and LG shall not be combined or consolidated with a dispute involving any other person’s or entity’s product or claim. More specifically, without limitation of the foregoing, any dispute between you and LG shall not under any circumstances proceed as part of a class or representative action. Instead of arbitration, either party may bring an individual action in small claims court, but that small claims court action may not be brought on a class or representative basis.

## 16 LIMITED WARRANTY

---

**Arbitration Rules and Procedures.** To begin arbitration of a claim, either you or LG must make a written demand for arbitration. The arbitration will be administered by the American Arbitration Association (“AAA”) and will be conducted before a single arbitrator under the AAA’s Consumer Arbitration Rules that are in effect at the time the arbitration is initiated (referred to as the “AAA Rules”) and under the procedures set forth in this section. The AAA Rules are available online at [www.adr.org/](http://www.adr.org/) consumer. Send a copy of your written demand for arbitration, as well as a copy of this provision, to the AAA in the manner described in the AAA Rules. You must also send a copy of your written demand to LG at LG Electronics, USA, Inc. Attn: Legal Department-Arbitration 111 Sylvan Avenue, Englewood Cliffs, NJ 07632. If there is a conflict between the AAA Rules and the rules set forth in this section, the rules set forth in this section will govern. This arbitration provision is governed by the Federal Arbitration Act. Judgment may be entered on the arbitrator’s award in any court of competent jurisdiction. All issues are for the arbitrator to decide, except that issues relating to the scope and enforceability of the arbitration provision and to the arbitrability of the dispute are for the court to decide. The arbitrator is bound by the terms of this provision.

**Governing Law.** The law of the state of your residence shall govern this Limited Warranty and any disputes between us except to the extent that such law is preempted by or inconsistent with applicable federal law.

**Fees/Costs.** You do not need to pay any fee to begin an arbitration. Upon receipt of your written demand for arbitration, LG will promptly pay all arbitration filing fees to the AAA unless you seek more than \$25,000 in damages, in which case the payment of these fees will be governed by the AAA Rules. Except as otherwise provided for herein, LG will pay all AAA filing, administration and arbitrator fees for any arbitration initiated in accordance with the AAA Rules and this arbitration provision. If you prevail in the arbitration, LG will pay your attorneys’ fees and expenses as long as they are reasonable, by considering factors including, but not limited to, the purchase amount and claim amount. Notwithstanding the foregoing, if applicable law allows for an award of reasonable attorneys’ fees and expenses, an arbitrator can award them to the same extent that a court would. If the arbitrator finds either the substance of your claim or the relief sought in the demand is frivolous or brought for an improper purpose (as measured by the standards set forth in Federal Rule of Civil Procedure 11(b)), then the payment of all arbitration fees will be governed by the AAA Rules. In such a situation, you agree to reimburse LG for all monies previously disbursed by it that are otherwise your obligation to pay under the AAA Rules. Except as otherwise provided for, LG waives any rights it may have to seek attorneys’ fees and expenses from you if LG prevails in the arbitration.

**Hearings and Location.** If your claim is for \$25,000 or less, you may choose to have the arbitration conducted solely on the basis of (1) documents submitted to the arbitrator, (2) through a telephonic hearing, or (3) by an in-person hearing as established by the AAA Rules. If your claim exceeds \$25,000, the right to a hearing will be determined by the AAA Rules. Any in-person arbitration hearings will be held at a location within the federal judicial district in which you reside unless we both agree to another location or we agree to a telephonic arbitration.

**Opt Out.** You may opt out of this dispute resolution procedure. If you opt out, neither you nor LG can require the other to participate in an arbitration proceeding. To opt out, you must send notice to LG no later than 30 calendar days from the date of the first consumer purchaser’s purchase of the product by either: (i) sending an e-mail to [optout@lge.com](mailto:optout@lge.com), with the subject line: “Arbitration Opt Out” or (ii) calling 1-800-980-2973. You must include in the opt out e-mail or provide by telephone: (a) your name and address; (b) the date on which the product was purchased; (c) the product model name or model number; and (d) the serial number (the serial number can be found (i) on the product; or (ii) online by accessing <https://www.lg.com/us/support/repair-service/schedule-repair-continued> and clicking on “Find My Model & Serial Number”).

You may only opt out of the dispute resolution procedure in the manner described above (that is, by e-mail or telephone); no other form of notice will be effective to opt out of this dispute resolution procedure. Opting out of this dispute resolution procedure will not affect the coverage of the Limited Warranty in any way, and you will continue to enjoy the full benefits of the Limited Warranty. If you keep this product and do not opt out, then you accept all terms and conditions of the arbitration provision described above.

## CANADA

### TERMS AND CONDITIONS

THE PRODUCT'S FULL LIMITED WARRANTY TERMS AND CONDITIONS ARE AVAILABLE AT [HTTPS://WWW.LGHVAC.COM](https://www.lghvac.com)

ARBITRATION NOTICE: THIS LIMITED WARRANTY CONTAINS AN ARBITRATION PROVISION THAT REQUIRES YOU AND LG TO RESOLVE DISPUTES BY BINDING ARBITRATION INSTEAD OF IN COURT, UNLESS THE LAWS OF YOUR PROVINCE OR TERRITORY DO NOT PERMIT THAT, OR, IN OTHER JURISDICTIONS, IF YOU CHOOSE TO OPT OUT. FOR FURTHER CLARITY, THIS ARBITRATION PROVISION IS NOT APPLICABLE TO CUSTOMERS RESIDING IN ONTARIO. IN ARBITRATION, CLASS ACTIONS AND JURY TRIALS ARE NOT PERMITTED. PLEASE SEE THE SECTION TITLED "PROCEDURE FOR RESOLVING DISPUTES" BELOW.

ENGLISH

### PROCEDURE FOR RESOLVING DISPUTES:

EXCEPT WHERE PROHIBITED BY LAW, ALL DISPUTES BETWEEN YOU AND LG ARISING OUT OF OR RELATING IN ANY WAY TO THIS LIMITED WARRANTY OR THE PRODUCT SHALL BE RESOLVED EXCLUSIVELY THROUGH BINDING ARBITRATION, AND NOT IN A COURT OF GENERAL JURISDICTION. EXCEPT WHERE PROHIBITED AT LAW, YOU AND LG BOTH IRREVOCABLY AGREE TO WAIVE THE RIGHT TO A JURY TRIAL AND TO BRING OR PARTICIPATE IN A CLASS ACTION. FOR CLARITY, THIS PROVISION DOES NOT APPLY TO CONSUMERS RESIDING IN ONTARIO.

**Definitions.** For the purposes of this section, references to "LG" mean LG Electronics Canada, Inc., its parents, subsidiaries and affiliates, and each of their officers, directors, employees, agents, beneficiaries, predecessors in interest, successors, assigns and suppliers; references to "dispute" or "claim" shall include any dispute, claim or controversy of any kind whatsoever (whether based in contract, tort, statute, regulation, ordinance, fraud, misrepresentation or any other legal or equitable theory) arising out of or relating in any way to the sale, condition or performance of the product or this Limited Warranty.

**Notice of Dispute.** In the event you intend to commence an arbitration proceeding, you must first notify LG in writing at least 30 days in advance of initiating the arbitration by sending a letter to LGECI Legal Team at 20 Norelco Drive, North York, Ontario, Canada M9L 2X6 (the "Notice of Dispute"). You and LG agree to engage in good faith discussions in an attempt to amicably resolve your claim. The notice must provide your name, address, and telephone number; identify the product that is the subject of the claim; and describe the nature of the claim and the relief being sought. If you and LG are unable to resolve the dispute within 30 days of LG's receipt of the Notice of Dispute, the dispute shall be resolved by binding arbitration in accordance with the procedure set out herein. You and LG both agree that, during the arbitration proceeding, the terms (including any amount) of any settlement offer made by either you or LG will not be disclosed to the arbitrator until the arbitrator determines the dispute.

**Agreement to Binding Arbitration and Class Action Waiver.** Upon failure to resolve the dispute during the 30 day period after LG's receipt of the Notice of Dispute, you and LG agree to resolve any claims between you and LG only by binding arbitration on an individual basis, unless you opt out as provided below, or you reside in a jurisdiction that prevents full application of this clause in the circumstances of the claims at issue (in which case if you are a consumer, this clause will only apply if you expressly agree to the arbitration). To the extent permitted by applicable law, any dispute between you and LG shall not be combined or consolidated with a dispute involving any other person's or entity's product or claim. Morespecifically, without limitation of the foregoing, except to the extent such a prohibition is not permitted at law, any dispute between you and LG shall not under any circumstances proceed as part of a class or representative action. Instead of arbitration, either party may bring an individual action in small claims court, but that small claims court action may not be brought on a class or representative basis except to the extent this prohibition is not permitted at law in your province or territory of jurisdiction as it relates to the claims at issue between you and LG. This does not apply to consumers in Ontario. In accordance with provincial legislation, the consumer and LG may agree to resolve the dispute using any procedure available, including commencing the action in the Superior Court of Justice.

## 18 LIMITED WARRANTY

---

**Arbitration Rules and Procedures.** To begin arbitration of a claim, either you or LG must make a written demand for arbitration. The arbitration will be private and confidential, and conducted on a simplified and expedited basis before a single arbitrator chosen by the parties under the provincial or territorial commercial arbitration law and rules of the province or territory of your residence. You must also send a copy of your written demand to LG at LG Electronics, Canada, Inc., Attn: Legal Department-Arbitration, 20 Norelco Drive, North York, Ontario M9L 2X6. This arbitration provision is governed by your applicable provincial or territorial commercial arbitration legislation. For consumers in Ontario, the applicable arbitration legislation only applies if consumers agree to submit the dispute to arbitration. Judgment may be entered on the arbitrator's award in any court of competent jurisdiction. All issues are for the arbitrator to decide, except that, issues relating to the scope and enforceability of the arbitration provision and to the arbitrability of the dispute are for the court to decide. The arbitrator is bound by the terms of this provision.

**Governing Law.** The law of the province or territory of your purchase shall govern this Limited Warranty and any disputes between you and LG except to the extent that such law is preempted by or inconsistent with applicable federal or provincial/territorial law. Should arbitration not be permitted for any claim, action, dispute or controversy between you and LG, you and LG attorn to the exclusive jurisdiction of the courts of the province or territory of your purchase for the resolution of the claim, action, dispute or controversy between you and LG.

**Fees/Costs.** You do not need to pay any fee to begin an arbitration. Upon receipt of your written demand for arbitration, LG will promptly pay all arbitration filing fees unless you seek more than \$25,000 in damages, in which case the payment of these fees will be governed by the applicable arbitration rules. Except as otherwise provided for herein, LG will pay all filing, administration and arbitrator fees for any arbitration initiated in accordance with the applicable arbitration rules and this arbitration provision. If you prevail in the arbitration, LG will pay your attorneys' fees and expenses as long as they are reasonable, by considering factors including, but not limited to, the purchase amount and claim amount. Notwithstanding the foregoing, if applicable law allows for an award of reasonable attorneys' fees and expenses, an arbitrator can award them to the same extent that a court would. If the arbitrator finds either the substance of your claim or the relief sought in the demand is frivolous or brought for an improper purpose (as measured by the applicable laws), then the payment of all arbitration fees will be governed by the applicable arbitration rules. In such a situation, you agree to reimburse LG for all monies previously disbursed by it that are otherwise your obligation to pay under the applicable arbitration rules. Except as otherwise provided for, LG waives any rights it may have to seek attorneys' fees and expenses from you if LG prevails in the arbitration.

**Hearings and Location.** If your claim is for \$25,000 or less, you may choose to have the arbitration conducted solely (1) on the basis of documents submitted to the arbitrator, (2) through a telephonic hearing, or (3) by an in-person hearing as established by the applicable arbitration rules. If your claim exceeds \$25,000, the right to a hearing will be determined by the applicable arbitration rules. Any in-person arbitration hearings will be held at the nearest, most mutually-convenient arbitration location available within the province or territory in which you reside unless you and LG both agree to another location or agree to a telephonic arbitration.

**Severability and Waiver.** If any portion of this Limited Warranty (including these arbitration procedures) is unenforceable, the remaining provisions will continue in full force and effect to the maximum extent permitted by applicable law. Should LG fail to enforce strict performance of any provision of this Limited Warranty (including these arbitration procedures), it does not mean that LG intends to waive or has waived any provision or part of this Limited Warranty.

**Opt Out.** The arbitration provision requires you and LG to resolve disputes by binding arbitration instead of court, unless the laws of your province or territory do not permit that, or, in other jurisdictions, if you choose to opt out. The arbitration provision does not apply to consumers in Ontario. For individuals that fall within the binding arbitration provisions, you may opt out of this dispute resolution procedure. If you opt out, neither you nor LG can require the other to participate in an arbitration proceeding. To opt out, you must send notice to LG no later than 30 calendar days from the date of the first consumer purchaser's purchase of the product by either (i) sending an e-mail to [optout@lge.com](mailto:optout@lge.com), with the subject line: "Arbitration Opt Out;" or (ii) calling 1-800-980-2973. You must include in the opt out e-mail or provide by telephone: (a) your name and address; (b) the date on which the product was purchased; (c) the product model name or model number; and (d) the serial number (the serial number can be found (i) on the product; or (ii) online by accessing [https://www.lg.com/ca\\_en/findmodel\\_serial/](https://www.lg.com/ca_en/findmodel_serial/)).

In the event that you "Opt Out", the law of the province or territory of your residence shall govern this Limited Warranty and any disputes between you and LG except to the extent that such law is preempted by or inconsistent with applicable federal or provincial/territorial law. Should arbitration not be permitted for any claim, action, dispute or controversy between you and LG, you and LG agree to attorn to the exclusive jurisdiction of the courts of the province or territory of your residence for the resolution of the claim, action, dispute or controversy between you and LG.

You may only opt out of the dispute resolution procedure in the manner described above (that is, by e-mail or telephone); no other form of notice will be effective to opt out of this dispute resolution procedure. Opting out of this dispute resolution procedure will not affect the coverage of the Limited Warranty in any way, and you will continue to enjoy the full benefits of the Limited Warranty. If you keep this product and do not opt out, then you accept all terms and conditions of the arbitration provision described above.

**Conflict of Terms.** In the event of a conflict or inconsistency between the terms of this Limited Warranty and the End User License Agreement ("EULA") in regards to dispute resolution, the terms of this Limited Warranty shall control and govern the rights and obligations of the parties and shall take precedence over the EULA.





## MANUEL D'UTILISATION

# CLIMATISEUR

---

Lea primeramente las INSTRUCCIONES DE SEGURIDAD IMPORTANTE en su totalidad.

Afin d'utiliser le produit de manière sûre et pratique, veuillez lire le manuel d'utilisation avant de l'utiliser.

### FRANÇAIS

TYPE: MONTAGE MURAL

K\*UAB\*\*1A, K\*UAK\*\*1A, KNMAB\*\*1A

[www.lghvac.com](http://www.lghvac.com)

[www.lg.com](http://www.lg.com)

Copyright © 2024 LG Electronics. Tous droits réservés

## **TABLE DES MATIÈRES**

### **3 FONCTIONNEMENT**

---

- 3 VOIR PLUS D'INFORMATIONS
- 3 Installation de l'application LG ThinQ et connexion d'un appareil LG (sur certains modèles)
- 4 TÉLÉCOMMANDE SANS FIL
- 7 NOUVELLES FONCTIONS
- 9 CONSEIL UTILE

### **9 APERÇU DU PRODUIT**

---

- 9 Montage mural

### **10 ENTRETIEN**

---

- 10 Retrait et remplacement du filtre à air
- 11 Nettoyage du filtre à air

### **12 DÉPANNAGE**

---

- 12 Avant d'appeler le réparateur

### **14 ANNEXE**

---

- 14 Renseignements sur l'avis de logiciel libre

### **15 GARANTIE LIMITÉE**

---

- 15 CANADA

# FONCTIONNEMENT

## VOIR PLUS D'INFORMATIONS

- 1 Le nom du modèle a été vérifié sur l'étiquette.

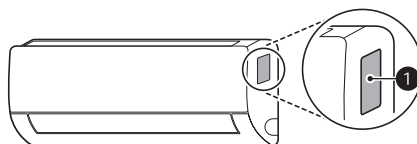

- 1 Étiquette

- 2 Recherche du nom du modèle sur [www.lg.com](http://www.lg.com).

### REMARQUE

- L'image peut varier en fonction du produit.

## Installation de l'application LG ThinQ et connexion d'un appareil LG (sur certains modèles)

### REMARQUE

- Cette fonction n'est offerte que sur les modèles dotés du Wi-Fi.

### Modèles avec code QR

Scannez le code QR joint au produit à l'aide de l'appareil photo ou d'une application de lecture de code QR sur votre smartphone.

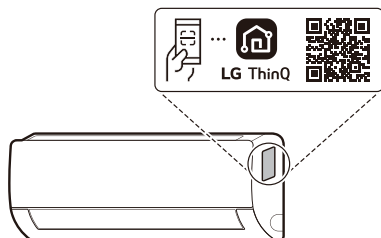

### Modèles sans code QR

Recherchez et installez l'application **LG ThinQ** depuis le Google Play Store ou l'Apple App Store sur un smartphone.

Exécutez l'application **LG ThinQ** et connectez-vous avec votre compte existant ou créez un compte LG pour vous connecter.

Touchez le bouton d'ajout (+) de l'application **LG ThinQ** pour connecter votre appareil LG. Suivez les instructions de l'application pour terminer le processus.

## 4 FONCTIONNEMENT





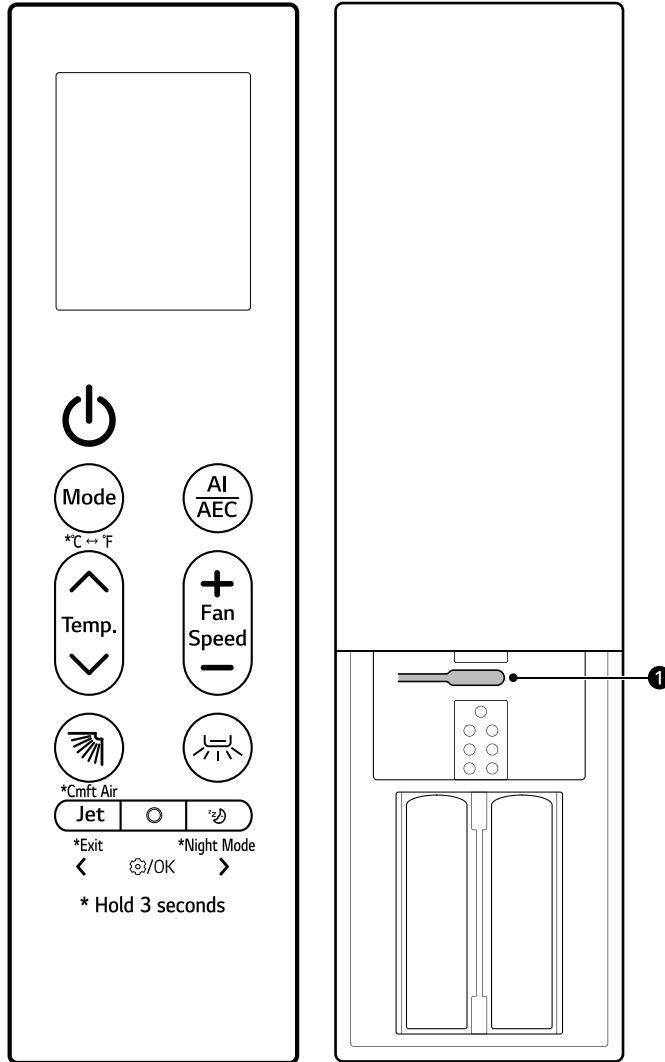

# TÉLÉCOMMANDE SANS FIL

Vous pouvez utiliser l'appareil plus facilement avec la télécommande sans fil.  
Pour des instructions plus détaillées, veuillez vous référer au manuel web.



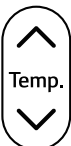



### REMARQUE

- Certaines fonctions ne sont pas prises en charge, selon le modèle concerné.

Image	Description
	<p><b>Marche/arrêt</b> Permet de mettre en marche ou d'arrêter l'appareil.</p> <hr/> <p><b>Connexion à LG ThinQ</b> Appuyez sur le bouton <b>Marche/arrêt</b> et maintenez-le enfoncé pendant environ 3 secondes pour préparer la connexion de l'appareil et du Wi-Fi.</p>
	<p><b>Mode</b> Sélectionne le mode de fonctionnement souhaité</p> <ul style="list-style-type: none"> <li>Chaque pression du doigt permet de changer de mode dans cet ordre : <b>Refroidissement</b> → <b>Automatique</b> → <b>Déshumidification</b> → <b>Chauffage</b> → <b>Ventilateur</b>.</li> </ul> <hr/> <p>°C ↔ °F</p> <p>Appuyez sur le bouton <b>Mode</b> et maintenez-le enfoncé pendant environ 3 secondes pour changer d'unité entre °C et °F.</p>
	<p><b>AI/AEC</b> Sélectionne <b>AI Smart Care</b> ou <b>Contrôle de l'énergie active</b> pour réduire la puissance absorbée.</p> <p><b>REMARQUE</b></p> <ul style="list-style-type: none"> <li>En cas de connexion à l'unité extérieure Multi, il se peut que <b>Contrôle de l'énergie active</b> fonctions ne soient pas prises en charge.</li> </ul>
	<p><b>Température ▲, ▼</b> Permet de régler la température de la pièce.</p>
	<p><b>Fan Speed +, -</b> Permet de régler la vitesse de ventilation.</p>
	<p> (<b>Oscillation haut/bas</b>) Permet de régler la direction du débit d'air vers le haut et vers le bas</p> <hr/> <p><b>Cmft Air</b> Appuyez sur le bouton  et maintenez-le enfoncé pendant environ 3 secondes pour régler la direction du flux d'air. Cela permet de minimiser le contact direct avec le flux d'air.</p>

## 6 FONCTIONNEMENT

Image	Description
	<b>↔ (Oscillation gauche/droite)</b> Permet de régler la direction du débit d'air vers la gauche ou la droite.
	<b>Jet</b> Modifie rapidement la température ambiante et fonctionne à la vitesse maximale du ventilateur. <b>Exit</b> Lorsque vous entrez dans les réglages, appuyez sur le bouton <b>Jet</b> et maintenez-le enfoncé pendant environ 3 secondes pour revenir au réglage précédent.
	<b>Fonction</b> Permet de sélectionner la fonction souhaitée. <b>REMARQUE</b> <ul style="list-style-type: none"><li>En cas de connexion à l'unité extérieur Multi, il se peut que <b>Chauffage à basse température</b> fonctions ne soient pas prises en charge.</li></ul>
	<b>☾ (Sommeil)</b> Éteint automatiquement l'appareil à l'heure souhaitée. À utiliser avant de dormir. <b>Night Mode</b> Appuyez sur le bouton ☾ et maintenez-le enfoncé pendant environ 3 secondes pour éteindre l'écran et le signal sonore.
	<b>① Réinitialiser</b> Réinitialise le réglage de la télécommande sans fil.

## NOUVELLES FONCTIONS

### Nettoyage intégral (sur certains modèles/LG ThinQ)

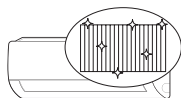

La congélation et la décongélation répétées de l'échangeur de chaleur du climatiseur permettent d'éliminer les contaminants tels que la poussière et de maintenir l'appareil propre.

Après le nettoyage, il réduit l'humidité à l'intérieur de l'unité intérieure.

Sur certaines unités intérieures, RL apparaît sur l'écran de l'unité intérieure.

#### REMARQUE

- La fonction de **Nettoyage intégral** s'arrête lorsque l'appareil a séché.
- Si l'humidité de la pièce est élevée lorsque la fonction **Nettoyage intégral** est activée, la zone située à proximité de l'unité intérieure peut s'embuer.
- La fonction **Nettoyage intégral** peut être utilisée à l'intérieur à une température comprise entre 70 °F (21 °C) et 90 °F (32 °C) et à l'extérieur à une température comprise entre 70 °F (21 °C) et 99 °F (37 °C). La fonction **Nettoyage intégral** est une fonction de gestion de l'hygiène et non une fonction de refroidissement. Les conditions d'utilisation peuvent donc varier par rapport à la plage de fonctionnement vérifiée de l'appareil.

- Si la fonction **Nettoyage intégral** est utilisée à une température en dehors de la plage autorisée, les alarmes de l'application **LG ThinQ** et la fonction ne fonctionnent pas.
- La fonction **Nettoyage intégral** est disponible même lorsque l'appareil est en marche.
- Si vous appuyez sur le bouton  de l'appareil ou de la télécommande pendant le **Nettoyage intégral**, la fonction **Nettoyage intégral** est désactivée.
- Pendant le **Nettoyage intégral**, un bruit de « tic-tac » ou de « tac-tac » peut se faire entendre lorsque l'appareil se dilate ou se contracte.
- Après le **Nettoyage intégral**, l'appareil s'éteint automatiquement. Lorsqu'il est remis sous tension, il fonctionne en mode **Refroidissement**.
- Si la fonction **Minuterie** est activée, la fonction **Nettoyage intégral** risque de ne pas fonctionner correctement.
- De l'air frais sort de la sortie lorsque la fonction **Nettoyage intégral** est activée.
- En cas de connexion à l'unité extérieur Multi, il se peut que ces fonctions ne soient pas prises en charge.

### Gestionnaire kW (sur certains modèles/LG ThinQ)

La consommation électrique du climatiseur est automatiquement ajustée en fonction d'un horaire et d'une consommation électrique cible définis par l'utilisateur.

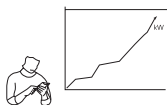

☐ apparaît sur l'écran de l'unité intérieure sur certains modèles.

#### REMARQUE

- Lors de l'utilisation de la fonction **Gestionnaire kW**, le débit d'air froid peut être réduit en fonction de la puissance cible restante.
- Lorsque la consommation d'électricité cible est dépassée, la fonction **Gestionnaire kW** est désactivée.
- Lorsque les modes **Chauffage** et **Automatique** sont utilisés, la fonction **Gestionnaire kW** est désactivée.
- En cas de connexion à l'unité extérieur Multi, il se peut que ces fonctions ne soient pas prises en charge.
- La consommation d'énergie indiquée par l'application **LG ThinQ** peut différer de la consommation d'énergie réelle indiquée sur votre facture d'électricité.
- Les informations relatives à la consommation d'énergie peuvent varier en fonction de l'appareil.
- La consommation d'énergie peut différer des résultats obtenus avec d'autres appareils de mesure.
- La consommation électrique mesurée peut varier en fonction de l'environnement dans lequel l'appareil est installé.
- La consommation d'énergie mesurée peut varier en fonction de l'environnement ou de la méthode d'utilisation de l'appareil domestique.
- Lors du réglage de la durée d'utilisation, l'appareil ne s'allume pas ou ne s'éteint pas automatiquement.
- Même pendant l'utilisation de la fonction **Gestionnaire kW**, la fonction réglée à l'aide de la télécommande est reflétée en premier.
- L'utilisation réelle peut différer.

### Sommeil+ (sur certains modèles/LG ThinQ)



Utilisez ce mode avant de dormir. L'appareil apprend et ajuste automatiquement la température et la vitesse du ventilateur pour créer un environnement de sommeil encore plus personnalisé.

#### REMARQUE

- Cette fonction peut être réglée lorsque l'appareil est sous tension.
- Cette fonction est disponible avec le mode **Refroidissement**.
- En cas de connexion à l'unité extérieur Multi, il se peut que ces fonctions ne soient pas prises en charge.

## CONSEIL UTILE

### Fonctionnement manuel

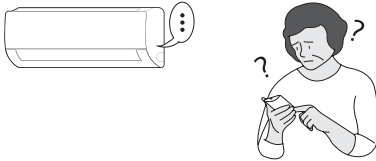

Si votre télécommande sans fil est indisponible, il est possible d'allumer ou d'éteindre l'appareil en appuyant sur le bouton **MARCHE/ARRÊT** ① de l'unité intérieure.

- 1 Ouvrez le volet haut/bas.
- 2 Appuyez sur le bouton **MARCHE/ARRÊT** ①.

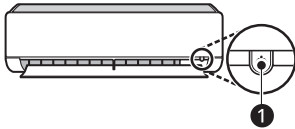

## APERÇU DU PRODUIT

### Montage mural

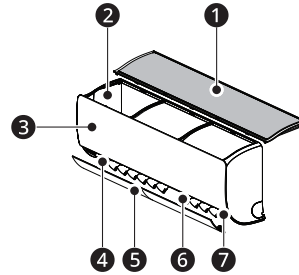

- ① Filtre à air
- ② Évents d'entrée d'air
- ③ Couvercle avant
- ④ Évents de sortie d'air
- ⑤ Déflecteur d'air (volet haut/bas)
- ⑥ Déflecteur d'air (ailettes gauche/droite)
- ⑦ Bouton Marche/arrêt

### REMARQUE

- Le nombre de pièces et leur emplacement peuvent varier en fonction du modèle de l'appareil.
- Les fonctionnalités peuvent varier en fonction du type de modèle.

# ENTRETIEN

## Retrait et remplacement du filtre à air

- 1 Coupez l'alimentation électrique de l'appareil.
- 2 Repérez les boutons du filtre à air situés sur la partie supérieure frontale du produit.

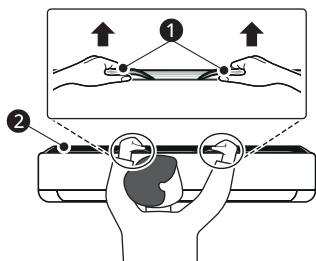

- 1 Boutons
- 2 Filtre à air

- 3 Tirez légèrement les boutons vers le haut, puis soulevez tout le filtre pour le retirer.

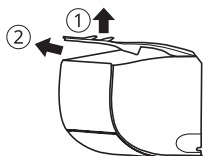

- 4 Insérez les crochets du filtre à air dans les fentes situées derrière le panneau frontal.

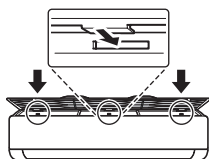

- 5 Abaissez les crochets jusqu'à ce qu'un déclic retentisse, indiquant qu'ils sont en place.

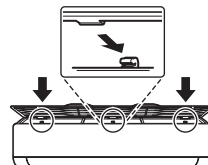

- 6 Pour vous assurer que le filtre est correctement installé, appuyez sur toute sa longueur frontale.

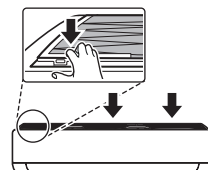

## Nettoyage du filtre à air

- 1 Retirez le filtre à air de l'appareil.
- 2 Nettoyez le filtre à air à l'aide d'un aspirateur ou lavez-le avec de l'eau tiède et un détergent doux.

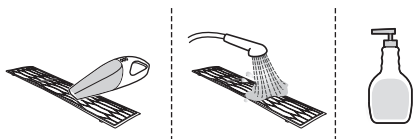

- 3 Laissez sécher le filtre à l'ombre.

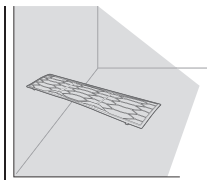

### REMARQUE

- Nettoyez le filtre à air toutes les deux semaines ou plus souvent, si nécessaire.
- Ne pliez pas le filtre à air, car il pourrait se casser.
- Ne faites pas fonctionner l'appareil sans que le filtre soit en place.
- Assemblez correctement le filtre à air, de sorte que ni poussière, ni d'autres substances ne s'infiltreront dans le produit.

# DÉPANNAGE

## Avant d'appeler le réparateur

Veillez vérifier les éléments suivants avant de communiquer avec le centre de service. Si le problème persiste, communiquez avec votre centre de service local.

### Fonction de diagnostic automatique

Cet appareil est équipé d'une fonction de **Diagnostic automatique** intégrée. En cas d'erreur, le voyant de l'appareil intérieur clignote par intervalles de 2 secondes. Si cela se produit, contactez votre revendeur ou centre de service local.

#### L'appareil ne fonctionne pas normalement.

- Une odeur de roussi ou un bruit étrange provient de l'appareil.
- De l'eau s'échappe de l'appareil intérieur même lorsque le niveau d'humidité est faible.
- Le câble d'alimentation est endommagé ou produit une chaleur excessive.
- Un commutateur, un disjoncteur (sécurité, mise à la masse) ou un fusible ne fonctionne pas correctement.
- La fonction de diagnostic automatique de l'appareil génère un code d'erreur.
  - Mettez l'appareil hors tension ou débranchez le câble d'alimentation, puis communiquez avec le centre de service.
- Système de détection de fuite de réfrigérant R32 est activé.
  - En cas de codes d'erreur tels que 228, 229 et 230, aérez la pièce et contactez immédiatement le personnel autorisé.
  - Si le code d'erreur est 236, la durée de vie du détecteur de fuites de réfrigérant est inférieure à 6 mois. Contactez immédiatement le personnel autorisé.

#### La vitesse de ventilation ne peut pas être réglée.

- Le mode Jet ou le mode Fonctionnement automatique est sélectionné.
  - Certains modes de fonctionnement ne permettent pas de régler la vitesse de ventilation. Sélectionnez un mode de fonctionnement qui vous permet de le faire.

#### Il est impossible de régler la température.

- Le mode Ventilateur ou le mode Jet est sélectionné.
  - Certains modes de fonctionnement ne permettent pas de régler la température. Sélectionnez un mode de fonctionnement qui vous permet de le faire.

#### L'appareil ne fonctionne pas.

- L'appareil est débranché.
  - Vérifiez si le cordon d'alimentation est branché dans la prise de courant ou si les isolateurs de courant sont activés.
- Un fusible a sauté ou l'alimentation est coupée.
  - Remplacez le fusible ou vérifiez si le disjoncteur s'est déclenché.
- Une panne d'électricité est survenue.
  - Mettez l'appareil hors tension lorsque survient une panne d'électricité.
  - Lorsque l'alimentation est restaurée, patientez pendant trois minutes, puis remettez l'appareil en marche.

- La tension est trop élevée ou trop faible.
  - Vérifiez si le disjoncteur s'est déclenché.
- L'appareil s'est arrêté automatiquement à une heure prédéfinie.
  - Allumez l'appareil.
- La pile de la télécommande sans fil n'est pas dans le bon sens ou mal insérée.
  - Vérifiez que les piles sont insérées correctement dans la télécommande sans fil.
  - Si les piles sont installées correctement et que l'appareil ne fonctionne toujours pas, remplacez les piles et essayez à nouveau.

### L'appareil ne génère pas d'air frais.

- L'air ne circule pas normalement.
  - Assurez-vous que des rideaux, des stores ou des meubles ne bloquent pas l'avant de l'appareil.
- Le filtre à air est sale.
  - Nettoyez le filtre à air une fois toutes les deux semaines.
  - Consultez la rubrique « **Nettoyage du filtre à air** » pour obtenir plus de renseignements.
- La température ambiante est trop élevée.
  - En été, le refroidissement de tout l'air intérieur peut demander un certain temps. Dans ce cas, sélectionnez le mode **Jet** pour refroidir rapidement l'air intérieur.
- L'air froid s'échappe de la pièce.
  - Assurez-vous qu'il n'y ait pas de fuite d'air froid au niveau des points de ventilation de la pièce.
- La température souhaitée est supérieure à la température actuelle.
  - Réglez la température souhaitée à un niveau inférieur à la température actuelle.
- Une source de chauffage se trouve à proximité du climatiseur.
  - Évitez d'utiliser un générateur de chaleur, comme les fours électriques ou les tables de cuisson, lorsque le climatiseur est en marche.
- Le mode Ventilateur est sélectionné.
  - En mode **Ventilateur**, l'appareil expulse de l'air sans refroidir ou chauffer l'air intérieur.
  - Basculez le mode de fonctionnement sur une opération de refroidissement.

### L'appareil intérieur continue de fonctionner même après avoir été éteint.

- La fonction Nettoyage automatique+ est en cours d'utilisation.
  - Laissez la fonction **Nettoyage automatique+** se poursuivre, car elle permet de réduire l'humidité qui reste dans l'unité intérieure. Si vous ne souhaitez pas utiliser cette fonction, vous pouvez arrêter l'unité intérieure.

### L'appareil ne génère pas d'air chaud.

- Lorsque le mode Chauffage démarre, le volet est presque fermé et aucun air ne sort, même si l'appareil extérieur fonctionne.
  - Cette situation est normale. Veuillez attendre jusqu'à ce que l'appareil ait généré suffisamment d'air chaud pour qu'il sorte de l'appareil.
- L'appareil extérieur est réglé sur le mode Dégivrage.
  - En mode **Chauffage**, de la glace et du givre s'accumulent sur les serpentins lorsque la température extérieure chute. Le mode **Dégivrage** réduit la couche de givre sur les serpentins et se termine en 15 minutes environ.

# ANNEXE

## Renseignements sur l'avis de logiciel libre

Pour obtenir le code source contenu dans ce produit, conformément aux dispositions de la licence publique générale, de la licence publique générale limitée, de la licence publique Mozilla et de toute autre licence régissant les logiciels à code source libre exigeant la divulgation du code source, visitez le site <https://opensource.lge.com>. En plus du code source, toutes les dispositions de licence, les avis de droits d'auteurs et autres documents pertinents peuvent aussi être consultés.

LG Electronics mettra également à votre disposition le code source libre sur CD-ROM pour un prix couvrant le coût de la distribution (coût du support, de l'expédition et de la manutention) sur simple demande par courriel à l'adresse [opensource@lge.com](mailto:opensource@lge.com).

Cette offre est valable pour une période de trois ans après notre dernière expédition de ce produit et s'applique à toute personne ayant reçu ces renseignements.

# GARANTIE LIMITÉE

## CANADA

### CONDITIONS GÉNÉRALES

LES TERMES ET CONDITIONS COMPLÈTES DE LA GARANTIE LIMITÉE DU PRODUIT SE TROUVENT SUR [HTTPS://WWW.LGHVAC.COM](https://www.lghvac.com).

AVIS D'ARBITRAGE : LA PRÉSENTE GARANTIE LIMITÉE CONTIENT UNE DISPOSITION RELATIVE À L'ARBITRAGE STIPULANT QUE VOUS ET LG DEVEZ RÉSOUDRE TOUT DIFFÉREND PAR ARBITRAGE PLUTÔT QUE DEVANT UN TRIBUNAL, À MOINS QUE LES LOIS DE VOTRE PROVINCE OU TERRITOIRE NE LE PERMETTENT PAS OU, DANS LE CAS D'AUTRES JURIDICTIONS, SI VOUS CHOISISSEZ DE VOUS RETIRER. PRÉCISONS QUE CETTE DISPOSITION D'ARBITRAGE N'EST PAS APPLICABLE AUX CLIENTS QUI RÉSIDENT EN ONTARIO. EN ARBITRAGE, LES RECOURS COLLECTIFS ET LES PROCÈS DEVANT JURY NE SONT PAS AUTORISÉS. VEUILLEZ CONSULTER LA SECTION INTITULÉE « PROCÉDURE DE RÈGLEMENT DES DIFFÉRENDS » CI-DESSOUS.

### PROCÉDURE DE RÈGLEMENT DE DIFFÉREND :

SAUF LÀ OÙ LA LOI L'INTERDIT, TOUTS LES DIFFÉRENDS ENTRE VOUS ET LG DÉCOULANT OU SE RAPPORTANT DE QUELQUE MANIÈRE QUE CE SOIT À CETTE GARANTIE LIMITÉE OU AU PRODUIT SERONT RÉSOLUS EXCLUSIVEMENT PAR ARBITRAGE EXÉCUTOIRE, ET NON DEVANT UN TRIBUNAL DE DROIT COMMUN. SAUF LÀ OÙ LA LOI L'INTERDIT, VOUS ET LG RENONCEZ IRRÉVOCABLEMENT AU DROIT À UN PROCÈS DEVANT JURY ET À INTENTER OU À PARTICIPER À UN RECOURS COLLECTIF. PRÉCISONS QUE CETTE DISPOSITION NE S'APPLIQUE PAS AUX CONSOMMATEURS QUI RÉSIDENT EN ONTARIO.

**Définitions.** Aux fins du présent article, « LG » désigne LG Electronics Canada Inc., ses sociétés mères, ses filiales et ses sociétés affiliées et tous leurs dirigeants, administrateurs, employés, agents, bénéficiaires, détenteurs précédents des mêmes droits, successeurs, cessionnaires et fournisseurs; « différend » et « réclamation » englobent tout différend, toute réclamation ou tout litige de quelque sorte que ce soit (fondés sur une responsabilité contractuelle, délictuelle, légale, réglementaire ou découlant d'une ordonnance, par fraude, fausse représentation ou sous quelque régime de responsabilité que ce soit) découlant de quelque façon que ce soit de la vente, des conditions ou de l'exécution du produit ou de la présente garantie limitée.

**Avis de différend.** Si vous prévoyez engager une procédure d'arbitrage, vous devez d'abord envoyer à LG un préavis écrit d'au moins 30 jours à l'adresse suivante : Équipe juridique LGEC1, 20 Norelco Drive, North York, Ontario, Canada M9L 2X6 (l'« avis de différend »). Vous et LG convenez de discuter en toute bonne foi pour tenter de régler le différend à l'amiable. L'avis doit mentionner votre nom, votre adresse, votre numéro de téléphone, le produit faisant l'objet de la réclamation, la nature de la réclamation et la réparation demandée. Si vous et LG ne parvenez pas à régler le différend dans les 30 jours suivant la réception de l'avis de différend par LG, le différend doit être réglé par arbitrage exécutoire conformément à la procédure établie aux présentes. Vous et LG convenez que, tout au long du processus d'arbitrage, les modalités (y compris les montants) de toute offre de règlement formulée par vous ou par LG ne seront pas divulguées à l'arbitre, jusqu'à ce que l'arbitre règle le différend.

## 16 GARANTIE LIMITÉE

**Accord sur l'arbitrage exécutoire et renonciation à un recours collectif.** À défaut de résoudre le différend au cours de la période de 30 jours suivant la réception par LG de l'avis de différend, vous et LG acceptez de résoudre toute réclamation entre vous et LG uniquement par arbitrage exécutoire sur une base individuelle, à moins que vous choisissiez de vous retirer, comme il est indiqué ci-dessous, ou que vous résidiez dans une province ou un territoire qui empêche la pleine application de cette clause dans les circonstances des réclamations en question (dans ce cas, si vous êtes un consommateur, cette clause ne s'appliquera que si vous acceptez expressément l'arbitrage). Dans la mesure permise par la loi applicable, tout différend entre vous et LG ne doit pas être combiné ou consolidé avec un différend impliquant le produit ou la réclamation de toute autre personne ou entité. Plus précisément, sans limitation de ce qui précède, sauf dans la mesure où une telle interdiction n'est pas permise par la loi, tout différend entre vous et LG ne pourra en aucun cas se poursuivre sous forme de recours collectif ou d'action dérivée. Au lieu de l'arbitrage, l'une ou l'autre des parties peut tenter une demande en justice auprès de la Cour des petites créances, mais cette demande auprès de la Cour des petites créances ne peut être intentée sous forme de recours collectif ou d'action dérivée, sauf dans la mesure où une telle interdiction n'est pas autorisée par la loi dans votre province ou territoire de compétence pour une réclamation en cause entre vous et LG. Cette disposition ne s'applique pas aux consommateurs de l'Ontario. Conformément à la législation provinciale, le consommateur et LG peuvent convenir de résoudre le litige en utilisant toute procédure disponible, y compris l'amorce d'une action devant la Cour supérieure de justice.

**Règles et procédures d'arbitrage.** Pour engager l'arbitrage d'une réclamation, une demande écrite d'arbitrage doit être soumise par vous ou LG. L'arbitrage sera privé et confidentiel, et se déroulera sur une base simplifiée et accélérée devant un arbitre unique choisi par les parties en vertu de la loi et des règles provinciales ou territoriales sur l'arbitrage commercial de la province ou du territoire où vous résidez. Vous devez également envoyer une copie de votre demande écrite à LG à l'adresse LG Electronics, Canada, Inc., Attn: Legal Department- Arbitration, 20, Norelco Drive, North York (Ontario), M9L 2X6. Cette disposition relative à l'arbitrage est régie par la législation provinciale ou territoriale applicable en matière d'arbitrage commercial. Pour les consommateurs de l'Ontario, la législation applicable en matière d'arbitrage ne s'applique que si les consommateurs acceptent de soumettre le litige à l'arbitrage. Un jugement peut être rendu sur décision de l'arbitre devant tout tribunal compétent. Toute question doit être tranchée par l'arbitre, à l'exception des questions relatives à la portée et à l'applicabilité de la disposition relative à l'arbitrage et à l'arbitrabilité du différend, qui doivent être tranchées par la cour. L'arbitre est lié par les modalités de cette disposition.

**Droit applicable.** Les lois de votre province ou territoire d'achat régissent la présente garantie limitée et tout différend entre vous et LG, sauf dans la mesure où de telles lois sont supplantées par des lois fédérales, provinciales ou territoriales applicables ou sont incompatibles avec ces dernières. Si l'arbitrage n'est pas autorisé pour régler une réclamation, une poursuite, un différend ou un litige entre vous et LG, vous et LG vous en remettez à la compétence exclusive des tribunaux de votre province ou territoire d'achat pour le règlement de la réclamation, de la poursuite, du différend ou du litige entre vous et LG.

**Frais et coûts.** Aucuns frais ne sont exigibles pour entamer une procédure d'arbitrage. À la réception de votre demande d'arbitrage écrite, LG règlera rapidement la totalité des frais de dépôt de la demande d'arbitrage, sauf si vous réclamez des dommages-intérêts supérieurs à 25 000 \$. Dans ce cas, le paiement de ces frais sera régi par les règles d'arbitrage applicables. Sauf disposition contraire aux présentes, LG paiera tous les frais de dépôt de demande et d'administration ainsi que les honoraires de l'arbitre conformément aux règles d'arbitrage applicables et à la présente disposition sur l'arbitrage. Si vous remportez l'arbitrage, LG règlera vos frais et honoraires juridiques après avoir déterminé s'ils sont raisonnables en se fondant sur des facteurs comme, entre autres, le montant de l'achat et le montant de la réclamation. Si l'arbitre juge que le motif de la réclamation ou les réparations demandées sont futiles ou se fondent sur des motifs déplacés (au regard des lois applicables), le paiement de tous les frais d'arbitrage sera régi par les règles d'arbitrage applicables. Dans un tel cas, vous acceptez de rembourser à LG la totalité des montants versés qu'il vous revient autrement de payer en vertu des règles d'arbitrage applicables. Sauf disposition contraire et si elle remporte l'arbitrage, LG renonce à tous ses droits de vous réclamer des frais et honoraires juridiques.

**Audience et lieu de l'arbitrage.** Si votre réclamation est égale ou inférieure à 25 000 \$, vous pouvez opter pour un arbitrage conduit selon l'une des modalités suivantes uniquement : 1) sur examen des documents remis à l'arbitre, 2) par audience téléphonique ou 3) par audience en personne selon les dispositions des règles d'arbitrage applicables. Si votre réclamation dépasse 25 000 \$, le droit à une audience sera défini par les règles d'arbitrage applicables. Les audiences arbitrales en personne se tiendront à l'endroit le plus proche et le plus pratique pour les deux parties situé dans votre province ou votre territoire de résidence, sauf si vous et LG convenez mutuellement d'un autre lieu ou d'un arbitrage par téléphone.

**Dissociabilité et renoncement.** Si une partie de la présente garantie limitée (y compris les présentes procédures d'arbitrage) n'est pas applicable, les dispositions restantes demeurent en vigueur dans toute la mesure permise par la loi applicable. Le fait de ne pas exiger la stricte exécution d'une disposition de la présente garantie limitée (y compris les présentes procédures d'arbitrage) ne signifie pas que LG renonce ou a l'intention de renoncer à toute disposition ou partie de la présente garantie limitée.

**Option de retrait.** La disposition d'arbitrage stipule que vous et LG devez résoudre tout différend par arbitrage exécutoire plutôt que devant un tribunal, à moins que les lois de votre province ou territoire ne le permettent pas, ou, dans le cas d'autres systèmes juridiques, si vous choisissez de vous retirer. Cette disposition d'arbitrage ne s'applique pas aux consommateurs de l'Ontario. Pour les personnes qui relèvent des dispositions relatives à l'arbitrage obligatoire, vous pouvez choisir de vous retirer de la présente procédure de résolution des différends. Si vous choisissez de vous retirer, ni vous ni LG ne pouvez obliger l'autre partie à participer à une procédure d'arbitrage. Pour vous retirer, vous devez envoyer un avis à LG dans les 30 jours civils à compter de la date d'achat du produit par le premier acheteur (i) en envoyant un courriel à [optout@lge.com](mailto:optout@lge.com) avec pour objet : « Retrait de l'arbitrage » ou (ii) en composant le 1-800-980-2973. Vous devez indiquer dans le courriel de retrait ou fournir par téléphone : (a) votre nom et adresse; (b) la date à laquelle le produit a été acheté; (c) le nom de modèle du produit ou le numéro de modèle; et (d) le numéro de série (le numéro de série se trouve (i) sur le produit ou (ii) en ligne en vous rendant au [https://www.lg.com/ca\\_en/findmodel\\_serial/](https://www.lg.com/ca_en/findmodel_serial/)).

Si vous vous prévaliez de l'option de retrait, les lois de votre province ou territoire de résidence régissent la présente garantie limitée et tout différend entre vous et LG, sauf dans la mesure où de telles lois sont supplantées par des lois fédérales, provinciales ou territoriales applicables ou sont incompatibles avec ces dernières. Si l'arbitrage n'est pas autorisé pour régler une réclamation, une poursuite, un différend ou un litige entre vous et LG, vous et LG vous en remettez à la compétence exclusive des tribunaux de votre province ou territoire de résidence pour le règlement de la réclamation, de la poursuite, du différend ou du litige entre vous et LG.

Vous ne pouvez vous prévaloir de l'option de retrait que de la manière décrite ci-dessus (c'est-à-dire par courriel ou par téléphone). Aucun autre type d'avis ne sera pris en compte pour le retrait de la présente procédure de règlement de différend. Le fait de se retirer de la présente procédure de règlement de différend ne compromet en aucune façon la protection accordée en vertu de la garantie limitée, et vous continuerez à jouir de tous les avantages prévus par la garantie limitée. Si vous conservez ce produit sans vous prévaloir de l'option de retrait, vous acceptez alors les conditions générales de la disposition sur l'arbitrage énoncée ci-dessus.

**Conflit de modalités.** En cas de conflit ou d'incompatibilité entre les modalités de la présente garantie limitée et le contrat de licence d'utilisation (« CLU ») en ce qui concerne le règlement des différends, les modalités de la présente garantie limitée contrôlent et régissent les droits et obligations des parties et ont préséance sur le CLU.

## 18 AIDE-MÉMOIRE

---



MANUAL DEL PROPIETARIO

# AIRE ACONDICIONADO

---

Lisez d'abord entièrement les CONSIGNES DE SÉCURITÉ  
IMPORTANTES.

Para utilizar el producto con seguridad y comodidad, lea el manual de  
instrucciones antes de utilizarlo.

**ESPAÑOL**

TIPO: MONTADO EN LA PARED

K\*UAB\*\*1A, K\*UAK\*\*1A, KNMAB\*\*1A

[www.lghvac.com](http://www.lghvac.com)

[www.lg.com](http://www.lg.com)

Copyright © 2024 LG Electronics. Todos los derechos reservados

## ÍNDICE

### 3 FUNCIONAMIENTO

---

- 3 VER MÁS INFORMACIÓN
- 3 Instalación de la aplicación LG ThinQ y conexión de un electrodoméstico LG (en algunos modelos)
- 4 CONTROL REMOTO INALÁMBRICO
- 7 NUEVAS FUNCIONES
- 9 CONSEJO ÚTIL

### 9 DESCRIPCIÓN GENERAL DEL PRODUCTO

---

- 9 Montado a la pared

### 10 MANTENIMIENTO

---

- 10 Eliminación y reemplazo del filtro de aire
- 11 Limpieza del filtro de aire

### 12 SOLUCIÓN DE PROBLEMAS

---

- 12 Antes de llamar al servicio técnico

### 14 APÉNDICE

---

- 14 Software de código abierto

### 15 GARANTÍA LIMITADA

---

- 15 EE. UU.

# FUNCIONAMIENTO

## VER MÁS INFORMACIÓN

- 1 Se revisó el nombre del modelo en la etiqueta.

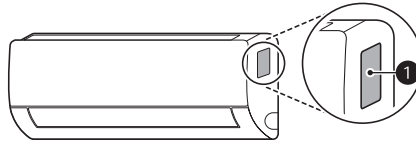

- 1 Etiqueta

- 2 Buscando el nombre del modelo en [www.lg.com](http://www.lg.com).

### NOTA

- La imagen podría variar dependiendo del producto.

## Instalación de la aplicación LG ThinQ y conexión de un electrodoméstico LG (en algunos modelos)

### NOTA

- Esta característica solo está disponible en modelos con Wi-Fi.

### Modelos con código QR

Escanee el código QR adjunto al producto utilizando la cámara o una aplicación lectora de códigos QR de su smartphone.

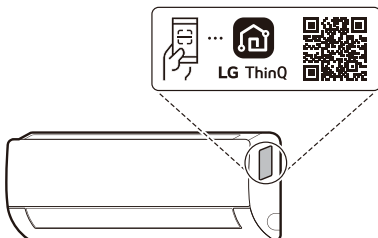

### Modelos sin código QR

Busque la aplicación **LG ThinQ** en la tienda Google Play o App Store e instálela en su teléfono inteligente.

Ejecute la aplicación **LG ThinQ** e inicie sesión con su cuenta existente o cree una cuenta LG para iniciar sesión.

Toque el botón para agregar (+) de la aplicación **LG ThinQ** para conectar su electrodoméstico LG. Siga las instrucciones de la aplicación para completar el proceso.

## 4 FUNCIONAMIENTO

# CONTROL REMOTO INALÁMBRICO





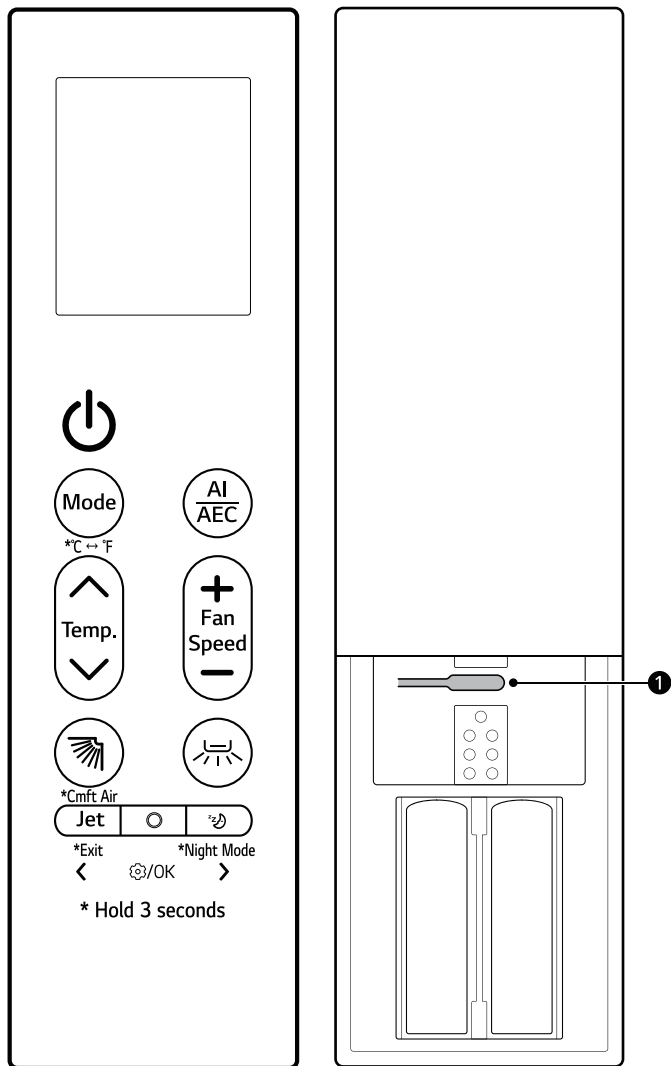

Puede operar el electrodoméstico con mayor comodidad utilizando el control remoto inalámbrico.

Para obtener instrucciones más detalladas, consulte el manual web.



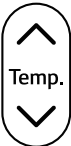





### NOTA

- De acuerdo con el modelo, es posible que algunas funciones no sean compatibles.

Imagen	Descripción
	<p><b>Encendido</b> Enciende o apaga el electrodoméstico.</p>
	<p><b>Conexión con LG ThinQ</b> Mantenga presionado el botón <b>Encendido</b> por unos 3 segundos para preparar la conexión del electrodoméstico y Wi-Fi.</p>
	<p><b>Mode</b> Selecciona el modo de funcionamiento que desee.</p> <ul style="list-style-type: none"> <li>• Cada pulsación cambia los modos en el siguiente orden: <b>Refrigeración</b> → <b>Automático</b> → <b>Deshumidificación</b> → <b>Calefacción</b> → <b>Ventilador</b></li> </ul> <p>°C ↔ °F</p> <p>Mantenga pulsado el botón <b>Mode</b> por 3 segundos aproximadamente para cambiar las unidades entre °C y °F</p>
	<p><b>AI/AEC</b> Seleccione <b>AI Smart Care</b> o <b>Control de energía activa</b> para disminuir la entrada de corriente eléctrica.</p> <p><b>NOTA</b></p> <ul style="list-style-type: none"> <li>• Cuando está conectado a la unidad exterior Multi, <b>Control de energía activa</b> función podría no ser compatible.</li> </ul>
	<p><b>Temperatura ▲, ▼</b> Ajusta la temperatura de ambiente deseada.</p>
	<p><b>Fan Speed +, -</b> Ajusta la velocidad del ventilador.</p>
	<p> <b>(Barrido arriba-abajo)</b> Ajusta la dirección del flujo de aire hacia arriba o hacia abajo.</p> <p><b>Cmft Air</b> Mantenga presionado el botón  por unos 3 segundos para ajustar la dirección del flujo de aire. Esto le ayudará a minimizar el contacto directo con el fujo de aire.</p>

## 6 FUNCIONAMIENTO

Imagen	Descripción
	<b>↔ (Barrido izquierda-derecha)</b> Ajusta la dirección del flujo de aire hacia la izquierda y hacia la derecha.
	<b>Jet</b> Cambia la temperatura de la habitación rápidamente. <b>Exit</b> Al establecer los ajustes, mantenga presionado el botón <b>Jet</b> por unos 3 segundos para regresar al ajuste anterior.
 	<b>Función</b> Selecciona la función deseada. <b>NOTA</b> <ul style="list-style-type: none"><li>• Cuando está conectado a la unidad exterior Multi, <b>Calefacción de ambiente baja</b> función podría no ser compatible.</li></ul>
	<b>☾ (Sueño)</b> Apaga automáticamente el electrodoméstico a la hora deseada. Úselo antes de dormir. <b>Night Mode</b> Mantenga pulsado el botón ☾ por unos 3 segundos para apagar la pantalla y el sonido de bip.
	<b>1 Restablecer</b> Restablece la configuración del control remoto inalámbrico.

## NUEVAS FUNCIONES

### Limpieza total (En algunos modelos/LG ThinQ)

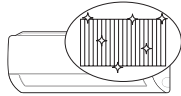

Al congelar y descongelar repetidamente el intercambiador de calor del aire acondicionado, se arrastran contaminantes como el polvo y el electrodoméstico se mantiene limpio.

Luego de la limpieza, reduce la humedad dentro de la unidad interior.

En algunas unidades interiores, **RiL** aparece en la pantalla de la unidad interior.

#### NOTA

- La función **Limpieza total** finalizará cuando el electrodoméstico se haya secado.
- Si la humedad de la habitación es alta cuando la función **Limpieza total** está en funcionamiento, el área cercana a la unidad interior podría empañarse.
- La función **Limpieza total** puede ser usada en interiores desde 70 °F (21 °C) a 90 °F (32 °C) y en exteriores desde 70 °F (21 °C) a 99 °F (37 °C). La función **Limpieza total** es una función de gestión de la higiene, y no una función de refrigeración, por lo que las condiciones de uso podrían variar comparadas con el rango de funcionamiento verificado del electrodoméstico.
- Si la función **Limpieza total** se hace funcionar a una temperatura fuera del rango permisible, la función y las alarmas de la aplicación **LG ThinQ** no funcionarán.
- La función **Limpieza total** está disponible incluso cuando el electrodoméstico está en funcionamiento.
- Si presiona el botón en el electrodoméstico o el control remoto durante **Limpieza total**, la función **Limpieza total** se desactiva.
- Durante la **Limpieza total**, un ruido de "tick-tick-" o "tack-tack" podría oírse al expandirse o contraerse el electrodoméstico.
- Después de la **Limpieza total**, el electrodoméstico se apagará automáticamente. Cuando se enciende de nuevo, funcionará en el modo **Refrigeración**.
- Si la función **Temporizador** se establece, la función **Limpieza total** podría no funcionar adecuadamente.
- La salida emite aire frío cuando la función **Limpieza total** se activa.
- Cuando está conectado a la unidad exterior Multi, esta función podría no ser compatible.

### Gerente de KW (En algunos modelos/LG ThinQ)

El consumo de energía del aire acondicionado se ajusta automáticamente en base a una programación y un consumo de energía objetivo establecido por el usuario.

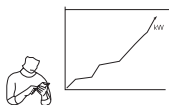

☐ aparece en la pantalla de la unidad interior en algunos modelos.

#### NOTA

- Cuando se usa la función **Gerente de KW**, la producción de aire frío podría reducirse, dependiendo de la cantidad de energía objetivo remanente.
- Cuando el consumo de electricidad objetivo se excede, la función **Gerente de KW** se deshabilita.
- Cuando se usan los modos **Calefacción y Automático**, la función **Gerente de KW** se deshabilita.
- Cuando está conectado a la unidad exterior Multi, esta función podría no ser compatible.
- El consumo de energía que se muestra a través de la aplicación **LG ThinQ** podría diferir del consumo de energía real que se muestre en su factura de electricidad.
- La información sobre el consumo de energía podría variar dependiendo del electrodoméstico.
- El consumo de energía podría diferir de los resultados medidos usando otros dispositivos de medición.
- Dependiendo del entorno en el que se instale el dispositivo, el consumo de energía medido podría variar.
- El consumo de energía medido podría variar dependiendo del entorno de consumo o el método de consumo del electrodoméstico.
- Al establecer el tiempo de uso, el electrodoméstico no se enciende o apaga automáticamente.
- Incluso durante el funcionamiento de la función **Gerente de KW**, la función establecida con el control remoto se refleja en primer lugar.
- El consumo real podría ser diferente.

### Sueño+ (En algunos modelos/LG ThinQ)



Usar antes de ir a dormir. El electrodoméstico aprenderá automáticamente y cambiará la temperatura y la velocidad del ventilador para crear un entorno incluso más personalizado durante el sueño.

#### NOTA

- Esta función puede configurarse cuando el electrodoméstico está encendido.
- Esta función está disponible en el modo **Enfriamiento**.
- Cuando está conectado a la unidad exterior Multi, esta función podría no ser compatible.

## CONSEJO ÚTIL

### Funcionamiento manual

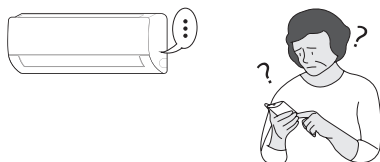

Si su control remoto inalámbrico no está disponible, puede encender o apagar el electrodoméstico con el botón **ENCENDIDO** ① en la unidad interior.

- 1 Abra el deflector ascendente-descendente.
- 2 Pulse el botón de **Encendido** ①.

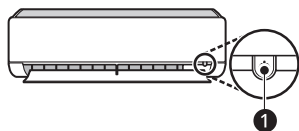

## DESCRIPCIÓN GENERAL DEL PRODUCTO

### Montado a la pared

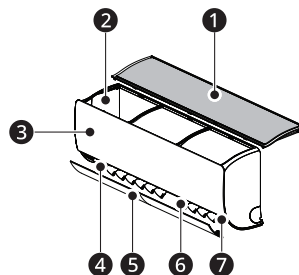

- ① Filtro de aire
- ② Conductos de entrada de aire
- ③ Cubierta delantera
- ④ Conductos de salida de aire
- ⑤ Deflector de aire (aleta ascendente-descendente)
- ⑥ Deflector de aire (rejilla izquierda y derecha)
- ⑦ Botón de encendido

### NOTA

- El número y la ubicación de las piezas pueden variar según el modelo de electrodoméstico.
- Las características pueden variar según el tipo de modelo.

# MANTENIMIENTO

## Eliminación y reemplazo del filtro de aire

- 1 Desconecte la electricidad del electrodoméstico.
- 2 Coloque las perillas del filtro de aire en la parte superior delantera del producto.

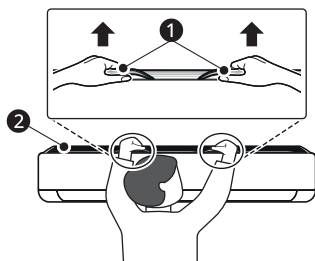

- 1 Perillas
- 2 Filtro de aire

- 3 Tire ligeramente hacia arriba de las perillas y, a continuación, levante el filtro completo para retirarlo.

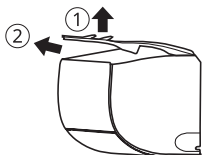

- 4 Inserte los ganchos en las ranuras de la parte trasera del panel delantero del filtro de aire.

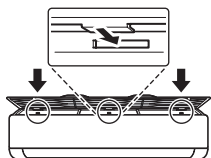

- 5 Tire de los ganchos hacia abajo hasta que encajen en su sitio.

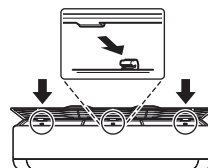

- 6 Para asegurarse de que el filtro esté montado correctamente, presione hacia abajo a lo largo de toda la parte delantera del filtro.

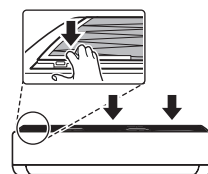

## Limpieza del filtro de aire

- 1 Retire el filtro de aire del electrodoméstico.
- 2 Limpie el filtro con una aspiradora o con agua tibia con detergente neutro.

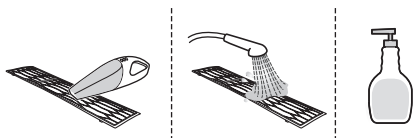

- 3 Deje secar el filtro a la sombra.

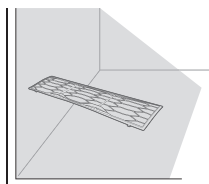

### NOTA

- Limpie los filtros de aire cada 2 semanas o con más frecuencia si es necesario.
- No doble el filtro de aire, ya que se puede romper.
- No haga funcionar el electrodoméstico sin el filtro en su lugar.
- Monte el filtro de aire correctamente para evitar que el polvo y otras sustancias entren en el producto.

# SOLUCIÓN DE PROBLEMAS

## Antes de llamar al servicio técnico

Verifique lo siguiente antes de comunicarse con el centro de servicio. Si el problema persiste, póngase en contacto con el centro de servicio local.

## Función de autodiagnóstico

Este electrodoméstico tiene incorporada una función de **Autodiagnóstico**. Si se produce un error, la luz de la unidad interior parpadeará en intervalos de 2 segundos. Si esto ocurre, póngase en contacto con su distribuidor o centro de servicio local.

### El electrodoméstico no funciona normalmente.

- La unidad emite olor a quemado y ruidos extraños.
- Sale agua de la unidad interior, incluso cuando el nivel de humedad es bajo.
- El cable de alimentación está dañado o genera un calor excesivo.
- Un interruptor, un disyuntor (de seguridad o a tierra) o un fusible no funciona correctamente.
- La unidad genera un código de error a partir del autodiagnóstico.
  - Apague el electrodoméstico, apague o desconecte el suministro de electricidad y comuníquese con el centro de servicio técnico.
- Se activa un sistema de detección de fugas de refrigerante R32.
  - Si aparecen códigos de error como 228, 229 y 230, ventile la habitación y póngase en contacto con el personal autorizado inmediatamente.
  - Si hay un código de error de 236, el detector de fugas de refrigerante dispone de una vida útil de menos de 6 meses. Póngase en contacto con personal autorizado inmediatamente.

### No se puede ajustar la velocidad del ventilador.

- Está seleccionado el modo Alta potencia o el modo Funcionamiento automático.
  - En algunos modos de funcionamiento, no se puede ajustar la velocidad del ventilador. Seleccione un modo de funcionamiento en el que se pueda ajustar la velocidad del ventilador.

### No se puede ajustar la temperatura.

- Está seleccionado el modo Alta potencia o el modo Ventilador.
  - En algunos modos de funcionamiento, no es posible ajustar la temperatura. Seleccione un modo de funcionamiento en el que se pueda ajustar la temperatura.

### El electrodoméstico no funciona.

- El electrodoméstico está desenchufado.
  - Compruebe que el cable de alimentación esté enchufado al tomacorriente y que los interruptores estén encendidos.
- Un fusible se fundió o el suministro de electricidad está bloqueado.
  - Reemplace el fusible o compruebe si no se activó el disyuntor.
- Se ha producido una falla en el suministro eléctrico.
  - Apague el electrodoméstico cuando se produzca un corte de energía.
  - Cuando vuelva la electricidad, espere tres minutos y luego vuelva a encenderlo.

- El voltaje es demasiado alto o demasiado bajo.
  - Compruebe si se activó el disyuntor.
- El electrodoméstico se apagó automáticamente a una hora predeterminada.
  - Encienda el electrodoméstico.
- La configuración de las baterías es incorrecta en el control remoto inalámbrico.
  - Asegúrese de que las baterías estén colocadas correctamente en el control remoto inalámbrico.
  - Si las baterías están colocadas correctamente y el electrodoméstico sigue sin funcionar, reemplace las baterías y vuelva a intentarlo.

#### El electrodoméstico no emite aire frío.

- El aire no circula correctamente.
  - Asegúrese de que no haya cortinas, persianas ni muebles que bloqueen el frente del electrodoméstico.
- El filtro de aire está sucio.
  - Limpie el filtro de aire cada dos semanas.
  - Para obtener más información, consulte la sección “**Limpieza del filtro de aire**”.
- La temperatura de la habitación es demasiado alta.
  - En verano, enfriar totalmente el aire del interior puede demorar. En este caso, seleccione el modo **Alta potencia** para enfriar el aire del interior rápidamente.
- El aire frío se escapa de la habitación.
  - Asegúrese de que el aire frío no se escape a través de los puntos de ventilación de la habitación.
- La temperatura deseada es mayor que la temperatura actual.
  - Configure la temperatura deseada en un nivel inferior que la temperatura actual.
- Hay una fuente de calor en las cercanías.
  - Evite el uso de generadores de calor, como hornos eléctricos o estufas de gas, mientras el aire acondicionado está en funcionamiento.
- Está seleccionado el modo Ventilador.
  - En el modo **Ventilador**, el aire sale del electrodoméstico sin refrigerar o calentar el aire interior.
  - Cambie el modo de operación a Enfriamiento.

#### La unidad interior sigue funcionando incluso cuando se ha apagado el electrodoméstico.

- Se está ejecutando la función Limpieza automática+.
  - Permita que la función **Limpieza automática+** continúe, ya que elimina cualquier resto de humedad dentro de la unidad interior. Si no desea que se ejecute esta función, puede apagar la unidad interior.

#### El electrodoméstico no emite aire caliente.

- Cuando se inicia el modo Calefacción, el deflector está casi cerrado y no sale aire, a pesar de que la unidad exterior está en funcionamiento.
  - Esto es normal. Espere hasta que la unidad haya generado suficiente aire caliente como para soplarlo a través de la unidad interior.
- La unidad exterior está en modo Descongelamiento.
  - En el modo **Calefacción**, cuando la temperatura exterior baja, se genera hielo/escarcha en las serpentinas. La función **Descongelamiento** elimina la capa de escarcha de la serpentina y debe terminar en aproximadamente 15 minutos.

# APÉNDICE

## Software de código abierto

Para obtener el código fuente bajo GPL, LGPL, MPL y otras licencias de código abierto que tienen la obligación de divulgar el código fuente, que está contenido en este producto, y para acceder a todos los términos de la licencia, avisos sobre derechos de autor y otros documentos relevantes, visite <https://opensource.lge.com>.

LG Electronics también le proporcionará el código abierto en un CD-ROM por un costo que cubra los gastos de dicha distribución (como el costo del medio, del envío y de la manipulación) una vez realizado el pedido por correo electrónico a la dirección [opensource@lge.com](mailto:opensource@lge.com).

Esta oferta es válida para todo aquel que reciba esta información durante un período de tres años después de que se envíe el último cargamento de este producto.

# GARANTÍA LIMITADA

## EE. UU.

### TÉRMINOS Y CONDICIONES

AVISO DE ARBITRAJE: ESTA GARANTÍA LIMITADA CONTIENE UNA DISPOSICIÓN DE ARBITRAJE QUE EXIGE QUE USTED Y LG ELECTRONICS ("LG" DE AQUÍ EN ADELANTE) RESUELVAN LOS CONFLICTOS MEDIANTE UN ARBITRAJE VINCULANTE EN LUGAR DE HACERLO ANTE TRIBUNALES, A MENOS QUE DECIDA NO PARTICIPAR. EN EL ARBITRAJE, LAS DEMANDAS COLECTIVAS Y LOS JUICIOS POR JURADOS NO ESTÁN PERMITIDOS. CONSULTE LA SECCIÓN TITULADA "PROCEDIMIENTO PARA RESOLVER CONFLICTOS" A CONTINUACIÓN.

### PROCEDIMIENTO PARA RESOLVER CONFLICTOS:

TODOS LOS CONFLICTOS ENTRE USTED Y LG QUE SURJAN EN RELACIÓN CON ESTA GARANTÍA LIMITADA O CON EL PRODUCTO SE RESOLVERÁN EXCLUSIVAMENTE A TRAVÉS DE UN ARBITRAJE VINCULANTE Y NO ANTE UN TRIBUNAL DE JURISDICCIÓN GENERAL. "ARBITRAJE VINCULANTE" SIGNIFICA QUE USTED Y LG RENUNCIAN AL DERECHO DE UN JUICIO CON JURADO Y A REALIZAR O PARTICIPAR EN UNA DEMANDA COLECTIVA.

**Definiciones.** Para el propósito de esta sección, las referencias a "LG" significan: LG Electronics U.S.A., Inc., sus empresas matrices, subsidiarias y filiales y cada uno de sus directivos, directores, empleados, agentes, beneficiarios, predecesores en interés, sucesores, cesionarios y proveedores; las referencias a "conflicto" o "reclamo" incluirán cualquier conflicto, reclamo o controversia de cualquier tipo (ya sea basado en contrato, agravio, estatuto, regulación, ordenanza, fraude, falsa representación o cualquier teoría legal o equitativa) que esté relacionada con cualquier forma de venta, condición o rendimiento del producto o de esta Garantía limitada.

**Aviso de conflicto.** En caso de que usted desee iniciar un procedimiento de arbitraje, primero debe notificar a LG por escrito al menos 30 días antes de iniciar el arbitraje; este aviso se presentará por carta a LG y se enviará a LG Electronics, USA, Inc., a la atención de Legal Department- Arbitration 111 Sylvan Avenue, Englewood Cliffs, NJ 07632. Usted y LG aceptan participar en discusiones de buena fe en un intento de resolver su reclamo de manera amistosa. En la carta debe indicar su nombre, dirección y número de teléfono, identificar el producto objeto del reclamo, y describir la naturaleza del reclamo y la solución que busca. Si usted y LG no pueden resolver el conflicto en un plazo de 30 días, cualquiera de las partes puede proceder a presentar una demanda de arbitraje.

**Acuerdo de arbitraje vinculante y renuncia de demanda colectiva.** En caso de no resolver el conflicto durante el período de 30 días después de enviar una notificación por escrito a LG, usted y LG se comprometen a resolver cualquier reclamo solamente a través de arbitraje vinculante sobre una base individual, a menos que usted se excluya, conforme a lo dispuesto a continuación. Cualquier conflicto entre usted y LG no se combinará ni consolidará con un conflicto relacionado con cualquier otro producto o reclamo de otra persona o entidad. Específicamente y sin perjuicio de lo anterior, no procederá bajo ninguna circunstancia cualquier conflicto entre usted y LG como parte de una demanda colectiva o representativa. En lugar del arbitraje, cualquiera de las partes podrá iniciar una acción individual ante un tribunal de reclamos menores, pero tales acciones en el tribunal de reclamos menores no podrán tomarse en una demanda colectiva o representativa.

## 16 GARANTÍA LIMITADA

**Normas y procedimientos de arbitraje.** Para comenzar con el arbitraje de un reclamo, usted o LG deben presentar una demanda escrita para arbitraje. El arbitraje será administrado por la Asociación Americana de Arbitraje (AAA) y se llevará a cabo ante un árbitro único de conformidad con las Normas de Arbitraje del Consumidor de la AAA, que tienen efecto al momento de inicio del arbitraje (en adelante, las "Normas de la AAA") y según los procedimientos establecidos en esta sección. Las Normas de la AAA están disponibles en línea en [www.adr.org/consumer](http://www.adr.org/consumer). Envíe una copia de su solicitud de arbitraje por escrito, así como una copia de esta disposición, a la AAA de la forma descrita en las Normas de la AAA. También debe enviar una copia de su solicitud por escrito a LG en LG Electronics, USA, Inc., a la atención de Legal Department- Arbitration 111 Sylvan Avenue, Englewood Cliffs, NJ 07632. Si hay un conflicto entre las Normas de la AAA y las reglas establecidas en esta sección, prevalecerán las reglas de esta sección. Esta disposición de arbitraje se rige por la Ley Federal de Arbitraje. El juicio se puede introducir en el laudo arbitral en cualquier tribunal de jurisdicción competente. El árbitro tomará su decisión en todas las cuestiones, excepto aquellos asuntos relativos al alcance y aplicabilidad de la cláusula de arbitraje y de la capacidad de arbitraje del conflicto para que el tribunal determine. El árbitro se regirá por los términos de esta disposición.

**Legislación vigente.** La legislación del estado de su residencia regirá esta Garantía limitada, así como todos los conflictos entre nosotros, salvo que sea invalidada o incoherente con leyes federales aplicables.

**Tarifas/costos.** No debe pagar ninguna tarifa para iniciar un arbitraje. Al recibir su solicitud de arbitraje por escrito, LG pagará todos los gastos administrativos rápidamente a la AAA, a menos que usted solicite más de \$25.000,00 por daños, en cuyo caso el pago de estos gastos se regirá por las Normas de la AAA. Salvo disposición contraria prevista en el presente documento, LG pagará a la AAA todos los gastos documentales, administrativos y de arbitraje para cualquier arbitraje iniciado, de conformidad con las Normas de la AAA y esta disposición de arbitraje. Si usted prevalece en el arbitraje, LG cubrirá los honorarios y gastos de sus abogados, siempre y cuando sean razonables, de conformidad con ciertos factores que incluyen, entre otros, el monto de la compra y el monto del reclamo. No obstante lo indicado, si la ley aplicable permite una adjudicación de honorarios y gastos razonables de abogados, un árbitro puede otorgarlos en la misma medida que lo haría un tribunal. Si el árbitro considera que el fondo de su reclamo o la reparación solicitada en la demanda es frívola o se utiliza para un propósito inadecuado (calificado según las normas establecidas en la Norma Federal de Procedimiento Civil 11 (b)), el pago de todos los honorarios de arbitraje se regirá por las Normas de la AAA. En tal situación, usted se compromete a reembolsar a LG todos los fondos que haya erogado previamente, cuyo pago es, por otra parte, su obligación según las Normas de la AAA. Salvo disposición contraria, LG renuncia a cualquier derecho que pudiera tener para solicitarle los honorarios y gastos de sus abogados, si LG prevalece en el arbitraje.

**Audiencias y ubicación.** Si su reclamo es por \$25.000 o menos, puede optar por que el arbitraje sea realizado únicamente sobre la base de lo siguiente: (1) documentos presentados al árbitro; (2) a través de una audiencia telefónica; o (3) mediante una audiencia presencial, según lo establecido por las Normas de la AAA. Si su reclamo excede los \$25.000, el derecho a una audiencia estará determinado por las Normas de la AAA. Cualquier audiencia de arbitraje presencial se realizará en un lugar dentro del distrito judicial federal en el cual resida, a menos que ambas partes acuerden llevarla a cabo en otra ubicación o mediante un arbitraje telefónico.

**Exclusión.** Puede excluirse de este procedimiento de resolución del conflicto. Si se excluye, ni usted ni LG pueden solicitar al otro que participe en un procedimiento de arbitraje. Para excluirse, debe enviar una notificación a LG en un plazo de hasta 30 días continuos a partir de la fecha de la primera compra del consumidor del producto, por alguno de estos medios: (i) el envío de un correo electrónico a [optout@lge.com](mailto:optout@lge.com) con el siguiente Asunto: "Exclusión del arbitraje"; o (ii) por teléfono si llama al 1-800-980-2973. Debe incluir la siguiente información en el correo electrónico de exclusión o suministrarla por teléfono: (a) su nombre y dirección; (b) la fecha en la cual se compró el producto; (c) el nombre o el número del modelo del producto; y (d) el número de serie (puede encontrarse (i) en el producto o (ii) en el sitio <https://www.lg.com/us/support/repair-service/schedule-repair-continued> al hacer clic en "Find My Model & Serial Number" [Buscar mi modelo y número de serie]).

Solo puede excluirse del procedimiento de resolución de conflictos en la forma descrita anteriormente (es decir, por correo electrónico o por teléfono); ninguna otra forma de notificación será efectiva para hacerlo. Excluirse de este procedimiento de resolución de conflictos no afectará de ninguna manera la cobertura de la Garantía limitada, por lo que usted continuará disfrutando de todos sus beneficios. Si conserva este producto y no se excluye, acepta todos los términos y condiciones de la cláusula de arbitraje descrita anteriormente.





US	Please call the installing contractor of your product, as warranty service will be provided by them.
CANADA	Service call Number # : (888) LG Canada, (888) 542-2623 Numéro pour les appels de service : LG Canada, 1-888-542-2623



OWNER'S MANUAL

# AIR CONDITIONER

---

Read the IMPORTANT SAFETY INSTRUCTIONS completely first.

In order to use the product safely and conveniently, please read the owner's manual before using the product.

ENGLISH FRANÇAIS ESPAÑOL

TYPE: WALL MOUNTED

K\*UAB\*\*1A, K\*UAK\*\*1A, KNMAB\*\*1A



MFL69491110  
Rev.01\_100824

[www.lghvac.com](http://www.lghvac.com)  
[www.lg.com](http://www.lg.com)

Copyright © 2024 LG Electronics. All Rights Reserved

## TABLE OF CONTENTS

### 3 OPERATION

---

- 3 SEE MORE INFORMATION
- 3 Installing LG ThinQ Application and Connecting an LG Appliance (On Some Models)
- 4 WIRELESS REMOTE CONTROL
- 7 NEW FUNCTIONS
- 9 HELPFUL TIP

### 9 PRODUCT OVERVIEWS

---

- 9 Wall Mounted

### 10 MAINTENANCE

---

- 10 Removing and Replacing the Air Filter
- 11 Cleaning the Air Filter

### 12 TROUBLESHOOTING

---

- 12 Before Calling for Service

### 14 APPENDIX

---

- 14 Open Source Software Notice Information

### 15 LIMITED WARRANTY

---

- 15 USA
- 17 CANADA

# OPERATION

## SEE MORE INFORMATION

- 1 Check the model name on the label.

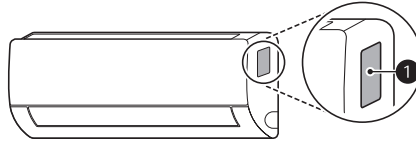

- 1 Label

- 2 Search for the model name at [www.lg.com](http://www.lg.com).

### NOTE

- The image may differ depending on the product.

## Installing LG ThinQ Application and Connecting an LG Appliance (On Some Models)

### NOTE

- This feature is only available on models with Wi-Fi.

### Models with QR Code

Scan the QR code attached to the product using the camera or a QR code reader application on your smartphone.

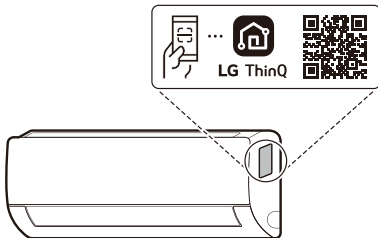

### Models without QR Code

Search for and install the **LG ThinQ** application from the Google Play Store or Apple App Store on a smartphone.

Run the **LG ThinQ** application and sign in with your existing account or create an LG account to sign in.

Touch the add (+) button on the **LG ThinQ** application to connect your LG appliance. Follow the instructions in the application to complete the process.

## 4 OPERATION

### WIRELESS REMOTE CONTROL



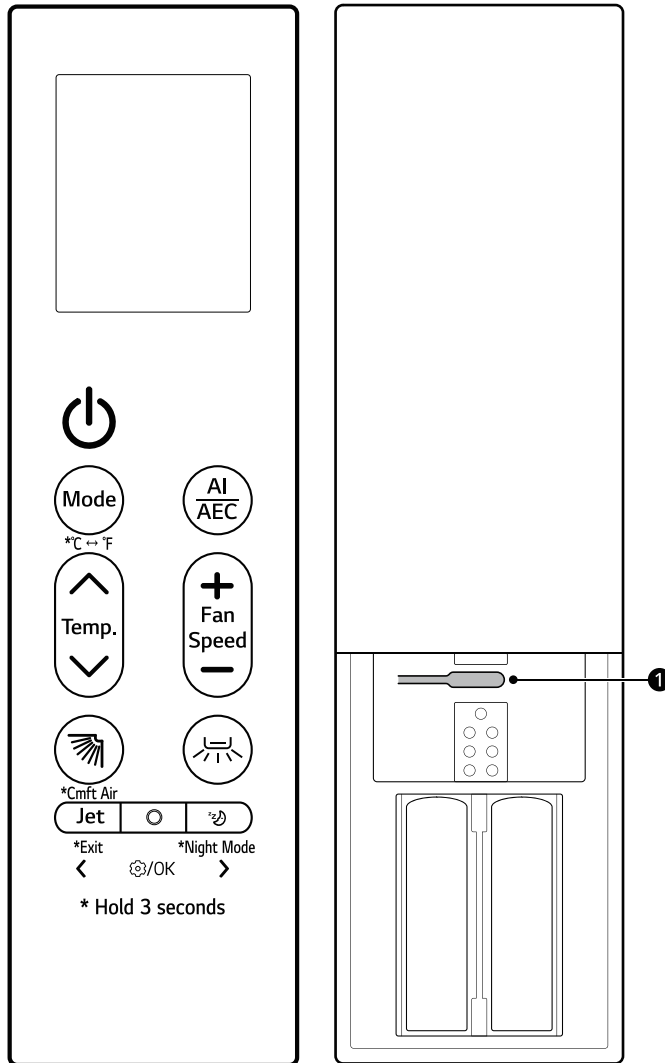

You can operate the appliance more conveniently with the wireless remote control.

For more detailed instructions, please refer to the Web-manual.





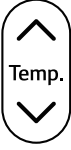







#### NOTE

- Some functions may not be supported, depending on the model.

Image	Description
	<p><b>Power</b> Turns the appliance on or off.</p>
	<p><b>Connecting to LG ThinQ</b> Press and hold the <b>Power</b> button for about 3 seconds to prepare for connecting appliance and Wi-Fi.</p>
	<p><b>Mode</b> Selects the desired operating mode.</p> <ul style="list-style-type: none"> <li>Each press changes the mode in this order: <b>Cooling</b> → <b>Auto</b> → <b>Dehumidification</b> → <b>Heating</b> → <b>Fan</b></li> </ul> <p>°C ↔ °F</p> <p>Press and hold the <b>Mode</b> button for about 3 seconds to change units between °C and °F</p>
	<p><b>AI/AEC</b> Selects <b>AI Smart Care</b> or <b>Active Energy Control</b> to decrease the power input.</p> <p><b>NOTE</b></p> <ul style="list-style-type: none"> <li>When connected to the Multi Outdoor unit, <b>Active Energy Control</b> function may not be supported.</li> </ul>
	<p><b>Temperature ▲, ▼</b> Adjusts the desired room temperature.</p>
	<p><b>Fan Speed +, -</b> Adjusts the fan speed.</p>
	<p><b>🌀 (Up-Down Swing)</b> Adjusts the airflow direction up and down.</p> <p><b>Cmft Air</b></p> <p>Press and hold the 🌀 button for about 3 seconds to adjust the airflow direction. This will help minimize direct contact with airflow.</p>

## 6 OPERATION

Image	Description
	<p> <b>(Left-Right Swing)</b> Adjusts the airflow direction left and right.</p>
	<p><b>Jet</b> Changes the room temperature quickly and operates at maximum fan speed.</p> <p><b>Exit</b> When entering the settings, press and hold the <b>Jet</b> button for about 3 seconds to return the previous setting.</p>
 	<p><b>Function</b> Selects the desired function.</p> <p><b>NOTE</b></p> <ul style="list-style-type: none"><li>When connected to the Multi Outdoor unit, <b>Low Ambient Heating</b> function may not be supported.</li></ul>
 	<p> <b>(Sleep)</b> Automatically turns the appliance off at a desired time. Use it before sleeping.</p> <p><b>Night Mode</b> Press and hold the  button for about 3 seconds to turn off the display and the beep sound.</p>
	<p><b>1 Reset</b> Resets the wireless remote control setting.</p>

## NEW FUNCTIONS

### All Cleaning (On Some Models/LG ThinQ)

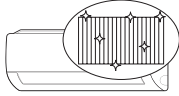

By repeatedly freezing and thawing the heat exchanger of the air conditioner, contaminants such as dust are washed away and the appliance is kept clean.

After cleaning, it reduces moisture inside the indoor unit.

On some indoor units, RL appears on the display of the indoor unit.

#### NOTE

- The **All Cleaning** function will end after the appliance has dried.
  - If the humidity in the room is high when the **All Cleaning** function is operating, the area near the indoor unit may become foggy.
  - The **All Cleaning** function can be used indoors at 70 °F (21 °C) to 90 °F (32 °C) and outdoors at 70 °F (21 °C) to 99 °F (37 °C). The **All Cleaning** function is a hygiene management function, not a cooling function, so the usage conditions may vary from the verified operation range of the appliance.
- If the **All Cleaning** function is operated at a temperature outside of the allowable range, alarms in the **LG ThinQ** application and the function does not work.
  - The **All Cleaning** function is available even when the appliance is running.
  - If you press the  button on the appliance or on the remote control during the **All Cleaning**, the **All Cleaning** function is deactivated.
  - During the **All Cleaning**, a “tick-tick-” or “tack-tack” noise may be heard as the appliance expands or contracts.
  - After the **All Cleaning**, the appliance will automatically shut off. When the power is turned back on, it will operate in **Cooling** mode.
  - If the **Timer** function is set, the **All Cleaning** function may not operate properly.
  - Cool air comes out of the outlet when the **All Cleaning** function is activated.
  - When connected to the Multi Outdoor unit, this functions may not be supported.

### kW Manager (On Some Models/LG ThinQ)

The air conditioner power consumption is automatically adjusted based on a schedule and target power consumption set by the user.

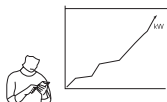

Ⓚ appears on the display of the indoor unit on some models.

#### NOTE

- When using **kW Manager** function, the output of cold air may be reduced, depending on the remaining target power amount.
- When the target electricity consumption is exceeded, the **kW Manager** function is disabled.
- When using the **Heating** and **Auto** modes, the **kW Manager** function is disabled.
- When connected to the Multi Outdoor unit, this functions may not be supported.
- The power usage shown through the **LG ThinQ** application may differ from the actual power usage shown on your utility bill.
- Power consumption information may vary depending on the appliance.
- Power consumption may differ from results measured using other measuring devices.
- Depending on the environment in which the device is installed, measured power consumption may vary.
- Measured power consumption may vary depending on the usage environment or usage method of the home appliance.
- When setting the usage time, the appliance does not automatically turn on or off.
- Even during the operation of the **kW Manager** function, the function set with the remote control is reflected first.
- Actual usage may differ.

### Sleep+ (On Some Models/LG ThinQ)



Use it before sleeping. The appliance will automatically learn and adjust the temperature and fan speed to create an even more personalized sleep environment.

#### NOTE

- This function can be set when the appliance is turned on.
- This function is available with the **Cooling** mode.
- When connected to the Multi Outdoor unit, this functions may not be supported.

## HELPFUL TIP

### Manual Operation

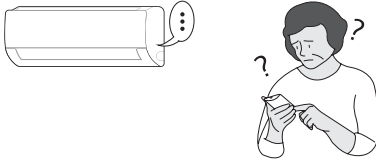

If your wireless remote control is unavailable, you can turn the appliance on and off by pressing the **POWER** button ① on the indoor unit.

- 1 Open the up-down vane.
- 2 Press the **POWER** button ①.

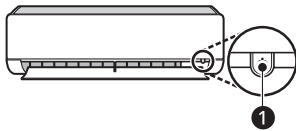

## PRODUCT OVERVIEWS

### Wall Mounted

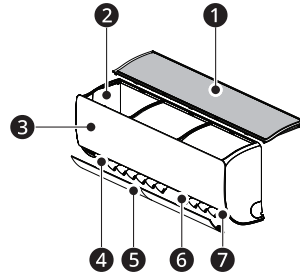

- ① Air Filter
- ② Air Intake Vents
- ③ Front Cover
- ④ Air Outlet Vents
- ⑤ Air Deflector (Up-Down Vane)
- ⑥ Air Deflector (Left-Right Louver)
- ⑦ Power Button

### NOTE

- The number and location of parts may vary depending on the model of the appliance.
- Features may change depending on the model type.

# MAINTENANCE

## Removing and Replacing the Air Filter

- 1 Turn off the power to the appliance.
- 2 Locate the knobs of the air filter on the top front of the appliance.

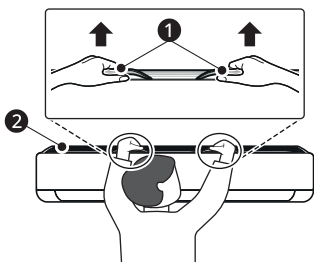

- 1 Knobs
- 2 Air Filter

- 3 Pull the knobs upward slightly and then lift the entire filter to remove it.

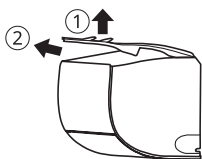

- 4 Insert the hooks on the air filter into the slots on the back of the front panel.

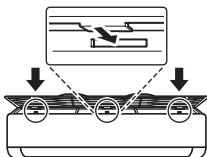

- 5 Push the hooks down until they click into place.

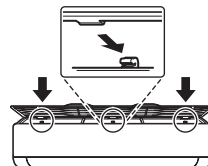

- 6 To make sure the filter is assembled properly, press down along the entire front length of the filter.

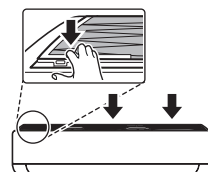

## Cleaning the Air Filter

- 1 Remove the air filter from the appliance.
- 2 Clean the air filter with a vacuum cleaner or wash it with lukewarm water and a mild detergent.

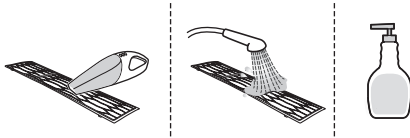

- 3 Dry the filter in the shade.

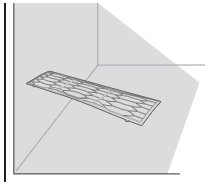

### NOTE

- Clean the air filter once every 2 weeks, or more if needed.
- Do not bend the air filter, as it may break.
- Do not operate the appliance without the filter in place.
- Assemble the air filter properly to prevent dust and other substances from entering the appliance.

# TROUBLESHOOTING

## Before Calling for Service

Please check the following before you contact the service centre. If the problem persists, contact your local service centre.

## Self-Diagnosis Function

This appliance has a built-in **self-diagnosis** function. If an error occurs, the lamp of the indoor unit will flash in 2-second intervals. If this occurs, contact your local dealer or service centre.

### The appliance does not work normally.

- Burning smell and strange sounds are coming from the appliance.
- Water leaks from the indoor unit even when the humidity level is low.
- The power cable is damaged or it is generating excessive heat.
- A switch, a circuit breaker (safety, ground) or a fuse is not operating properly.
- The appliance generates an error code from its self-diagnosis.
  - Turn off the appliance, switch off or disconnect the power supply, and contact the service centre.
- R32 refrigerant leakage detecting system is activated.
  - If there are error code such as 228,229 and 230, ventilate the room and contact authorized personnel immediately.
  - If there is an error code of 236, the refrigerant leak detector has a lifetime of less than 6 months. Contact authorized personnel immediately.

### The fan speed cannot be adjusted.

- The Jet mode or Auto Operation mode is selected.
  - In some operating modes, you cannot adjust the fan speed. Select an operating mode in which you can adjust the fan speed.

### The temperature cannot be adjusted.

- The Fan mode or Jet mode is selected.
  - In some operating modes, you cannot adjust the temperature. Select an operating mode in which you can adjust the temperature.

### The appliance does not work.

- The appliance is unplugged.
  - Check whether the power cord is plugged into the outlet or the power isolators are switched on.
- A fuse exploded or the power supply is blocked.
  - Replace the fuse or check if the circuit breaker has tripped.
- A power failure has occurred.
  - Turn off the appliance when a power failure occurs.
  - When the power is restored, wait 3 minutes, and then turn on the appliance.

- The voltage is too high or too low.
  - Check if the circuit breaker has tripped.
- The appliance was turned off automatically at a preset time.
  - Turn the appliance on.
- The battery setting in the wireless remote control is incorrect.
  - Make sure that the batteries are inserted correctly in your wireless remote control.
  - If the batteries are placed correctly, but the appliance still does not operate, replace the batteries and try again.

#### The appliance does not emit cool air.

- Air is not circulating properly.
  - Make sure that there are no curtains, blinds, or pieces of furniture blocking the front of the appliance.
- The air filter is dirty.
  - Clean the air filter once every 2 weeks.
  - See “**Cleaning the Air Filter**” for more information.
- The room temperature is too high.
  - In summer, cooling the indoor air fully may take some time. In this case, select the **Jet** mode to cool the indoor air quickly.
- Cold air is escaping from the room.
  - Make sure that no cold air is escaping through the ventilation points in the room.
- The desired temperature is higher than the current temperature.
  - Set the desired temperature to a level lower than the current temperature.
- There is a heating source nearby.
  - Avoid using heat generators like electric ovens or gas hobs while the air conditioner is in operation.
- Fan mode is selected.
  - During **Fan** mode, air blows from the appliance without cooling or heating the indoor air.
  - Switch the operating mode to cooling operation.

#### The indoor unit is still operating even when the appliance has been turned off.

- The Auto Clean+ function is being operated.
  - Allow the **Auto Clean+** function to continue since it reduces any remaining moisture inside the indoor unit. If you do not want this function, you can turn the indoor unit off.

#### The appliance does not emit warm air.

- When the Heating mode starts, the vane is almost closed, and no air comes out, even though the outdoor unit is operating.
  - This is normal. Please wait until the appliance has generated enough warm air to blow through the indoor unit.
- The outdoor unit is in Defrosting mode.
  - In **Heating** mode, ice and frost is built up on the coils when the outside temperature falls. The **Defrosting** mode reduces a layer of frost on the coil, and it should finish in approximately 15 minutes.

# APPENDIX

## Open Source Software Notice Information

To obtain the source code that is contained in this product, under GPL, LGPL, MPL, and other open source licenses that have the obligation to disclose source code, and to access all referred license terms, copyright notices and other relevant documents, please visit <https://opensource.lge.com>.

LG Electronics will also provide open source code to you on CD-ROM for a charge covering the cost of performing such distribution (such as the cost of media, shipping, and handling) upon email request to [opensource@lge.com](mailto:opensource@lge.com).

This offer is valid to anyone in receipt of this information for a period of three years after our last shipment of this product.

# LIMITED WARRANTY

## USA

### TERMS AND CONDITIONS

ARBITRATION NOTICE: THIS LIMITED WARRANTY CONTAINS AN ARBITRATION PROVISION THAT REQUIRES YOU AND LG ELECTRONICS (“LG”) TO RESOLVE DISPUTES BY BINDING ARBITRATION INSTEAD OF IN COURT, UNLESS YOU CHOOSE TO OPT OUT. IN ARBITRATION, CLASS ACTIONS AND JURY TRIALS ARE NOT PERMITTED. PLEASE SEE THE SECTION TITLED “PROCEDURE FOR RESOLVING DISPUTES” BELOW.

ENGLISH

### PROCEDURE FOR RESOLVING DISPUTES:

ALL DISPUTES BETWEEN YOU AND LG ARISING OUT OF OR RELATING IN ANY WAY TO THIS LIMITED WARRANTY OR THE PRODUCT SHALL BE RESOLVED EXCLUSIVELY THROUGH BINDING ARBITRATION, AND NOT IN A COURT OF GENERAL JURISDICTION. BINDING ARBITRATION MEANS THAT YOU AND LG ARE EACH WAIVING THE RIGHT TO A JURY TRIAL AND TO BRING OR PARTICIPATE IN A CLASS ACTION.

**Definitions.** For the purposes of this section, references to “LG” mean LG Electronics U.S.A., Inc., its parents, subsidiaries and affiliates, and each of their officers, directors, employees, agents, beneficiaries, predecessors in interest, successors, assigns and suppliers; references to “dispute” or “claim” shall include any dispute, claim or controversy of any kind whatsoever (whether based in contract, tort, statute, regulation, ordinance, fraud, misrepresentation or any other legal or equitable theory) arising out of or relating in any way to the sale, condition or performance of the product or this Limited Warranty.

**Notice of Dispute.** In the event you intend to commence an arbitration proceeding, you must first notify LG in writing at least 30 days in advance of initiating the arbitration by sending a letter to LG at LG Electronics, USA, Inc. Attn: Legal Department-Arbitration 111 Sylvan Avenue, Englewood Cliffs, NJ 07632. You and LG agree to engage in good faith discussions in an attempt to amicably resolve your claim. The notice must provide your name, address, and telephone number; identify the product that is the subject of the claim; and describe the nature of the claim and the relief being sought. If you and LG are unable to resolve the dispute within 30 days, either party may proceed to file a claim for arbitration.

**Agreement to Binding Arbitration and Class Action Waiver.** Upon failure to resolve the dispute during the 30 day period after sending written notice to LG, you and LG agree to resolve any claims between us only by binding arbitration on an individual basis, unless you opt out as provided below. Any dispute between you and LG shall not be combined or consolidated with a dispute involving any other person’s or entity’s product or claim. More specifically, without limitation of the foregoing, any dispute between you and LG shall not under any circumstances proceed as part of a class or representative action. Instead of arbitration, either party may bring an individual action in small claims court, but that small claims court action may not be brought on a class or representative basis.

## 16 LIMITED WARRANTY

---

**Arbitration Rules and Procedures.** To begin arbitration of a claim, either you or LG must make a written demand for arbitration. The arbitration will be administered by the American Arbitration Association (“AAA”) and will be conducted before a single arbitrator under the AAA’s Consumer Arbitration Rules that are in effect at the time the arbitration is initiated (referred to as the “AAA Rules”) and under the procedures set forth in this section. The AAA Rules are available online at [www.adr.org/](http://www.adr.org/) consumer. Send a copy of your written demand for arbitration, as well as a copy of this provision, to the AAA in the manner described in the AAA Rules. You must also send a copy of your written demand to LG at LG Electronics, USA, Inc. Attn: Legal Department-Arbitration 111 Sylvan Avenue, Englewood Cliffs, NJ 07632. If there is a conflict between the AAA Rules and the rules set forth in this section, the rules set forth in this section will govern. This arbitration provision is governed by the Federal Arbitration Act. Judgment may be entered on the arbitrator’s award in any court of competent jurisdiction. All issues are for the arbitrator to decide, except that issues relating to the scope and enforceability of the arbitration provision and to the arbitrability of the dispute are for the court to decide. The arbitrator is bound by the terms of this provision.

**Governing Law.** The law of the state of your residence shall govern this Limited Warranty and any disputes between us except to the extent that such law is preempted by or inconsistent with applicable federal law.

**Fees/Costs.** You do not need to pay any fee to begin an arbitration. Upon receipt of your written demand for arbitration, LG will promptly pay all arbitration filing fees to the AAA unless you seek more than \$25,000 in damages, in which case the payment of these fees will be governed by the AAA Rules. Except as otherwise provided for herein, LG will pay all AAA filing, administration and arbitrator fees for any arbitration initiated in accordance with the AAA Rules and this arbitration provision. If you prevail in the arbitration, LG will pay your attorneys’ fees and expenses as long as they are reasonable, by considering factors including, but not limited to, the purchase amount and claim amount. Notwithstanding the foregoing, if applicable law allows for an award of reasonable attorneys’ fees and expenses, an arbitrator can award them to the same extent that a court would. If the arbitrator finds either the substance of your claim or the relief sought in the demand is frivolous or brought for an improper purpose (as measured by the standards set forth in Federal Rule of Civil Procedure 11(b)), then the payment of all arbitration fees will be governed by the AAA Rules. In such a situation, you agree to reimburse LG for all monies previously disbursed by it that are otherwise your obligation to pay under the AAA Rules. Except as otherwise provided for, LG waives any rights it may have to seek attorneys’ fees and expenses from you if LG prevails in the arbitration.

**Hearings and Location.** If your claim is for \$25,000 or less, you may choose to have the arbitration conducted solely on the basis of (1) documents submitted to the arbitrator, (2) through a telephonic hearing, or (3) by an in-person hearing as established by the AAA Rules. If your claim exceeds \$25,000, the right to a hearing will be determined by the AAA Rules. Any in-person arbitration hearings will be held at a location within the federal judicial district in which you reside unless we both agree to another location or we agree to a telephonic arbitration.

**Opt Out.** You may opt out of this dispute resolution procedure. If you opt out, neither you nor LG can require the other to participate in an arbitration proceeding. To opt out, you must send notice to LG no later than 30 calendar days from the date of the first consumer purchaser’s purchase of the product by either: (i) sending an e-mail to [optout@lge.com](mailto:optout@lge.com), with the subject line: “Arbitration Opt Out” or (ii) calling 1-800-980-2973. You must include in the opt out e-mail or provide by telephone: (a) your name and address; (b) the date on which the product was purchased; (c) the product model name or model number; and (d) the serial number (the serial number can be found (i) on the product; or (ii) online by accessing <https://www.lg.com/us/support/repair-service/schedule-repair-continued> and clicking on “Find My Model & Serial Number”).

You may only opt out of the dispute resolution procedure in the manner described above (that is, by e-mail or telephone); no other form of notice will be effective to opt out of this dispute resolution procedure. Opting out of this dispute resolution procedure will not affect the coverage of the Limited Warranty in any way, and you will continue to enjoy the full benefits of the Limited Warranty. If you keep this product and do not opt out, then you accept all terms and conditions of the arbitration provision described above.

## CANADA

### TERMS AND CONDITIONS

THE PRODUCT'S FULL LIMITED WARRANTY TERMS AND CONDITIONS ARE AVAILABLE AT [HTTPS://WWW.LGHVAC.COM](https://www.lghvac.com)

ARBITRATION NOTICE: THIS LIMITED WARRANTY CONTAINS AN ARBITRATION PROVISION THAT REQUIRES YOU AND LG TO RESOLVE DISPUTES BY BINDING ARBITRATION INSTEAD OF IN COURT, UNLESS THE LAWS OF YOUR PROVINCE OR TERRITORY DO NOT PERMIT THAT, OR, IN OTHER JURISDICTIONS, IF YOU CHOOSE TO OPT OUT. FOR FURTHER CLARITY, THIS ARBITRATION PROVISION IS NOT APPLICABLE TO CUSTOMERS RESIDING IN ONTARIO. IN ARBITRATION, CLASS ACTIONS AND JURY TRIALS ARE NOT PERMITTED. PLEASE SEE THE SECTION TITLED "PROCEDURE FOR RESOLVING DISPUTES" BELOW.

ENGLISH

### PROCEDURE FOR RESOLVING DISPUTES:

EXCEPT WHERE PROHIBITED BY LAW, ALL DISPUTES BETWEEN YOU AND LG ARISING OUT OF OR RELATING IN ANY WAY TO THIS LIMITED WARRANTY OR THE PRODUCT SHALL BE RESOLVED EXCLUSIVELY THROUGH BINDING ARBITRATION, AND NOT IN A COURT OF GENERAL JURISDICTION. EXCEPT WHERE PROHIBITED AT LAW, YOU AND LG BOTH IRREVOCABLY AGREE TO WAIVE THE RIGHT TO A JURY TRIAL AND TO BRING OR PARTICIPATE IN A CLASS ACTION. FOR CLARITY, THIS PROVISION DOES NOT APPLY TO CONSUMERS RESIDING IN ONTARIO.

**Definitions.** For the purposes of this section, references to "LG" mean LG Electronics Canada, Inc., its parents, subsidiaries and affiliates, and each of their officers, directors, employees, agents, beneficiaries, predecessors in interest, successors, assigns and suppliers; references to "dispute" or "claim" shall include any dispute, claim or controversy of any kind whatsoever (whether based in contract, tort, statute, regulation, ordinance, fraud, misrepresentation or any other legal or equitable theory) arising out of or relating in any way to the sale, condition or performance of the product or this Limited Warranty.

**Notice of Dispute.** In the event you intend to commence an arbitration proceeding, you must first notify LG in writing at least 30 days in advance of initiating the arbitration by sending a letter to LGECI Legal Team at 20 Norelco Drive, North York, Ontario, Canada M9L 2X6 (the "Notice of Dispute"). You and LG agree to engage in good faith discussions in an attempt to amicably resolve your claim. The notice must provide your name, address, and telephone number; identify the product that is the subject of the claim; and describe the nature of the claim and the relief being sought. If you and LG are unable to resolve the dispute within 30 days of LG's receipt of the Notice of Dispute, the dispute shall be resolved by binding arbitration in accordance with the procedure set out herein. You and LG both agree that, during the arbitration proceeding, the terms (including any amount) of any settlement offer made by either you or LG will not be disclosed to the arbitrator until the arbitrator determines the dispute.

**Agreement to Binding Arbitration and Class Action Waiver.** Upon failure to resolve the dispute during the 30 day period after LG's receipt of the Notice of Dispute, you and LG agree to resolve any claims between you and LG only by binding arbitration on an individual basis, unless you opt out as provided below, or you reside in a jurisdiction that prevents full application of this clause in the circumstances of the claims at issue (in which case if you are a consumer, this clause will only apply if you expressly agree to the arbitration). To the extent permitted by applicable law, any dispute between you and LG shall not be combined or consolidated with a dispute involving any other person's or entity's product or claim. Morespecifically, without limitation of the foregoing, except to the extent such a prohibition is not permitted at law, any dispute between you and LG shall not under any circumstances proceed as part of a class or representative action. Instead of arbitration, either party may bring an individual action in small claims court, but that small claims court action may not be brought on a class or representative basis except to the extent this prohibition is not permitted at law in your province or territory of jurisdiction as it relates to the claims at issue between you and LG. This does not apply to consumers in Ontario. In accordance with provincial legislation, the consumer and LG may agree to resolve the dispute using any procedure available, including commencing the action in the Superior Court of Justice.

## 18 LIMITED WARRANTY

---

**Arbitration Rules and Procedures.** To begin arbitration of a claim, either you or LG must make a written demand for arbitration. The arbitration will be private and confidential, and conducted on a simplified and expedited basis before a single arbitrator chosen by the parties under the provincial or territorial commercial arbitration law and rules of the province or territory of your residence. You must also send a copy of your written demand to LG at LG Electronics, Canada, Inc., Attn: Legal Department-Arbitration, 20 Norelco Drive, North York, Ontario M9L 2X6. This arbitration provision is governed by your applicable provincial or territorial commercial arbitration legislation. For consumers in Ontario, the applicable arbitration legislation only applies if consumers agree to submit the dispute to arbitration. Judgment may be entered on the arbitrator's award in any court of competent jurisdiction. All issues are for the arbitrator to decide, except that, issues relating to the scope and enforceability of the arbitration provision and to the arbitrability of the dispute are for the court to decide. The arbitrator is bound by the terms of this provision.

**Governing Law.** The law of the province or territory of your purchase shall govern this Limited Warranty and any disputes between you and LG except to the extent that such law is preempted by or inconsistent with applicable federal or provincial/territorial law. Should arbitration not be permitted for any claim, action, dispute or controversy between you and LG, you and LG attorn to the exclusive jurisdiction of the courts of the province or territory of your purchase for the resolution of the claim, action, dispute or controversy between you and LG.

**Fees/Costs.** You do not need to pay any fee to begin an arbitration. Upon receipt of your written demand for arbitration, LG will promptly pay all arbitration filing fees unless you seek more than \$25,000 in damages, in which case the payment of these fees will be governed by the applicable arbitration rules. Except as otherwise provided for herein, LG will pay all filing, administration and arbitrator fees for any arbitration initiated in accordance with the applicable arbitration rules and this arbitration provision. If you prevail in the arbitration, LG will pay your attorneys' fees and expenses as long as they are reasonable, by considering factors including, but not limited to, the purchase amount and claim amount. Notwithstanding the foregoing, if applicable law allows for an award of reasonable attorneys' fees and expenses, an arbitrator can award them to the same extent that a court would. If the arbitrator finds either the substance of your claim or the relief sought in the demand is frivolous or brought for an improper purpose (as measured by the applicable laws), then the payment of all arbitration fees will be governed by the applicable arbitration rules. In such a situation, you agree to reimburse LG for all monies previously disbursed by it that are otherwise your obligation to pay under the applicable arbitration rules. Except as otherwise provided for, LG waives any rights it may have to seek attorneys' fees and expenses from you if LG prevails in the arbitration.

**Hearings and Location.** If your claim is for \$25,000 or less, you may choose to have the arbitration conducted solely (1) on the basis of documents submitted to the arbitrator, (2) through a telephonic hearing, or (3) by an in-person hearing as established by the applicable arbitration rules. If your claim exceeds \$25,000, the right to a hearing will be determined by the applicable arbitration rules. Any in-person arbitration hearings will be held at the nearest, most mutually-convenient arbitration location available within the province or territory in which you reside unless you and LG both agree to another location or agree to a telephonic arbitration.

**Severability and Waiver.** If any portion of this Limited Warranty (including these arbitration procedures) is unenforceable, the remaining provisions will continue in full force and effect to the maximum extent permitted by applicable law. Should LG fail to enforce strict performance of any provision of this Limited Warranty (including these arbitration procedures), it does not mean that LG intends to waive or has waived any provision or part of this Limited Warranty.

**Opt Out.** The arbitration provision requires you and LG to resolve disputes by binding arbitration instead of court, unless the laws of your province or territory do not permit that, or, in other jurisdictions, if you choose to opt out. The arbitration provision does not apply to consumers in Ontario. For individuals that fall within the binding arbitration provisions, you may opt out of this dispute resolution procedure. If you opt out, neither you nor LG can require the other to participate in an arbitration proceeding. To opt out, you must send notice to LG no later than 30 calendar days from the date of the first consumer purchaser's purchase of the product by either (i) sending an e-mail to [optout@lge.com](mailto:optout@lge.com), with the subject line: "Arbitration Opt Out;" or (ii) calling 1-800-980-2973. You must include in the opt out e-mail or provide by telephone: (a) your name and address; (b) the date on which the product was purchased; (c) the product model name or model number; and (d) the serial number (the serial number can be found (i) on the product; or (ii) online by accessing [https://www.lg.com/ca\\_en/findmodel\\_serial/](https://www.lg.com/ca_en/findmodel_serial/)).

In the event that you "Opt Out", the law of the province or territory of your residence shall govern this Limited Warranty and any disputes between you and LG except to the extent that such law is preempted by or inconsistent with applicable federal or provincial/territorial law. Should arbitration not be permitted for any claim, action, dispute or controversy between you and LG, you and LG agree to attorn to the exclusive jurisdiction of the courts of the province or territory of your residence for the resolution of the claim, action, dispute or controversy between you and LG.

You may only opt out of the dispute resolution procedure in the manner described above (that is, by e-mail or telephone); no other form of notice will be effective to opt out of this dispute resolution procedure. Opting out of this dispute resolution procedure will not affect the coverage of the Limited Warranty in any way, and you will continue to enjoy the full benefits of the Limited Warranty. If you keep this product and do not opt out, then you accept all terms and conditions of the arbitration provision described above.

**Conflict of Terms.** In the event of a conflict or inconsistency between the terms of this Limited Warranty and the End User License Agreement ("EULA") in regards to dispute resolution, the terms of this Limited Warranty shall control and govern the rights and obligations of the parties and shall take precedence over the EULA.





## MANUEL D'UTILISATION

# CLIMATISEUR

---

Lea primeramente las INSTRUCCIONES DE SEGURIDAD IMPORTANTE en su totalidad.

Afin d'utiliser le produit de manière sûre et pratique, veuillez lire le manuel d'utilisation avant de l'utiliser.

### FRANÇAIS

TYPE: MONTAGE MURAL

K\*UAB\*\*1A, K\*UAK\*\*1A, KNMAB\*\*1A

[www.lghvac.com](http://www.lghvac.com)  
[www.lg.com](http://www.lg.com)

Copyright © 2024 LG Electronics. Tous droits réservés

## **TABLE DES MATIÈRES**

### **3 FONCTIONNEMENT**

---

- 3 VOIR PLUS D'INFORMATIONS
- 3 Installation de l'application LG ThinQ et connexion d'un appareil LG (sur certains modèles)
- 4 TÉLÉCOMMANDE SANS FIL
- 7 NOUVELLES FONCTIONS
- 9 CONSEIL UTILE

### **9 APERÇU DU PRODUIT**

---

- 9 Montage mural

### **10 ENTRETIEN**

---

- 10 Retrait et remplacement du filtre à air
- 11 Nettoyage du filtre à air

### **12 DÉPANNAGE**

---

- 12 Avant d'appeler le réparateur

### **14 ANNEXE**

---

- 14 Renseignements sur l'avis de logiciel libre

### **15 GARANTIE LIMITÉE**

---

- 15 CANADA

# FONCTIONNEMENT

## VOIR PLUS D'INFORMATIONS

- 1 Le nom du modèle a été vérifié sur l'étiquette.

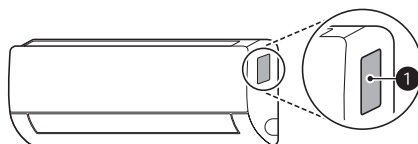

- 1 Étiquette

- 2 Recherche du nom du modèle sur [www.lg.com](http://www.lg.com).

### REMARQUE

- L'image peut varier en fonction du produit.

## Installation de l'application LG ThinQ et connexion d'un appareil LG (sur certains modèles)

### REMARQUE

- Cette fonction n'est offerte que sur les modèles dotés du Wi-Fi.

### Modèles avec code QR

Scannez le code QR joint au produit à l'aide de l'appareil photo ou d'une application de lecture de code QR sur votre smartphone.

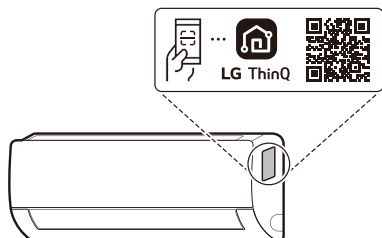

### Modèles sans code QR

Recherchez et installez l'application **LG ThinQ** depuis le Google Play Store ou l'Apple App Store sur un smartphone.

Exécutez l'application **LG ThinQ** et connectez-vous avec votre compte existant ou créez un compte LG pour vous connecter.

Touchez le bouton d'ajout (+) de l'application **LG ThinQ** pour connecter votre appareil LG. Suivez les instructions de l'application pour terminer le processus.

## 4 FONCTIONNEMENT





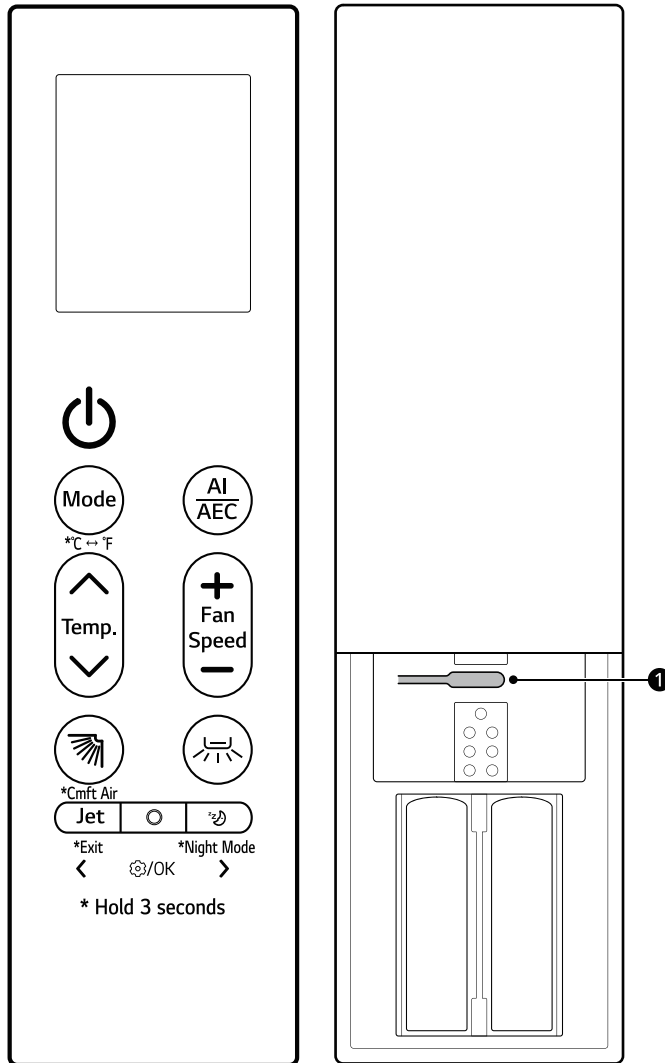

# TÉLÉCOMMANDE SANS FIL

Vous pouvez utiliser l'appareil plus facilement avec la télécommande sans fil.  
Pour des instructions plus détaillées, veuillez vous référer au manuel web.



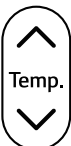



### REMARQUE

- Certaines fonctions ne sont pas prises en charge, selon le modèle concerné.

Image	Description
	<p><b>Marche/arrêt</b> Permet de mettre en marche ou d'arrêter l'appareil.</p> <hr/> <p><b>Connexion à LG ThinQ</b> Appuyez sur le bouton <b>Marche/arrêt</b> et maintenez-le enfoncé pendant environ 3 secondes pour préparer la connexion de l'appareil et du Wi-Fi.</p>
	<p><b>Mode</b> Sélectionne le mode de fonctionnement souhaité</p> <ul style="list-style-type: none"> <li>• Chaque pression du doigt permet de changer de mode dans cet ordre : <b>Refroidissement</b> → <b>Automatique</b> → <b>Déshumidification</b> → <b>Chauffage</b> → <b>Ventilateur</b>.</li> </ul> <hr/> <p>°C ↔ °F</p> <p>Appuyez sur le bouton <b>Mode</b> et maintenez-le enfoncé pendant environ 3 secondes pour changer d'unité entre °C et °F.</p>
	<p><b>AI/AEC</b> Sélectionne <b>AI Smart Care</b> ou <b>Contrôle de l'énergie active</b> pour réduire la puissance absorbée.</p> <p><b>REMARQUE</b></p> <ul style="list-style-type: none"> <li>• En cas de connexion à l'unité extérieur Multi, il se peut que <b>Contrôle de l'énergie active</b> fonctions ne soient pas prises en charge.</li> </ul>
	<p><b>Température ▲, ▼</b> Permet de régler la température de la pièce.</p>
	<p><b>Fan Speed +, -</b> Permet de régler la vitesse de ventilation.</p>
	<p> (<b>Oscillation haut/bas</b>) Permet de régler la direction du débit d'air vers le haut et vers le bas</p> <hr/> <p><b>Cmft Air</b> Appuyez sur le bouton  et maintenez-le enfoncé pendant environ 3 secondes pour régler la direction du flux d'air. Cela permet de minimiser le contact direct avec le flux d'air.</p>

## 6 FONCTIONNEMENT

Image	Description
	<b>↔ (Oscillation gauche/droite)</b> Permet de régler la direction du débit d'air vers la gauche ou la droite.
	<b>Jet</b> Modifie rapidement la température ambiante et fonctionne à la vitesse maximale du ventilateur. <b>Exit</b> Lorsque vous entrez dans les réglages, appuyez sur le bouton <b>Jet</b> et maintenez-le enfoncé pendant environ 3 secondes pour revenir au réglage précédent.
	<b>Fonction</b> Permet de sélectionner la fonction souhaitée. <b>REMARQUE</b> <ul style="list-style-type: none"><li>En cas de connexion à l'unité extérieur Multi, il se peut que <b>Chauffage à basse température</b> fonctions ne soient pas prises en charge.</li></ul>
	<b>☾ (Sommeil)</b> Éteint automatiquement l'appareil à l'heure souhaitée. À utiliser avant de dormir. <b>Night Mode</b> Appuyez sur le bouton ☾ et maintenez-le enfoncé pendant environ 3 secondes pour éteindre l'écran et le signal sonore.
	<b>1 Réinitialiser</b> Réinitialise le réglage de la télécommande sans fil.

## NOUVELLES FONCTIONS

### Nettoyage intégral (sur certains modèles/LG ThinQ)

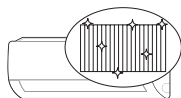

La congélation et la décongélation répétées de l'échangeur de chaleur du climatiseur permettent d'éliminer les contaminants tels que la poussière et de maintenir l'appareil propre.

Après le nettoyage, il réduit l'humidité à l'intérieur de l'unité intérieure.

Sur certaines unités intérieures, PL apparaît sur l'écran de l'unité intérieure.

#### REMARQUE

- La fonction de **Nettoyage intégral** s'arrête lorsque l'appareil a séché.
- Si l'humidité de la pièce est élevée lorsque la fonction **Nettoyage intégral** est activée, la zone située à proximité de l'unité intérieure peut s'embuer.
- La fonction **Nettoyage intégral** peut être utilisée à l'intérieur à une température comprise entre 70 °F (21 °C) et 90 °F (32 °C) et à l'extérieur à une température comprise entre 70 °F (21 °C) et 99 °F (37 °C). La fonction **Nettoyage intégral** est une fonction de gestion de l'hygiène et non une fonction de refroidissement. Les conditions d'utilisation peuvent donc varier par rapport à la plage de fonctionnement vérifiée de l'appareil.

- Si la fonction **Nettoyage intégral** est utilisée à une température en dehors de la plage autorisée, les alarmes de l'application **LG ThinQ** et la fonction ne fonctionnent pas.
- La fonction **Nettoyage intégral** est disponible même lorsque l'appareil est en marche.
- Si vous appuyez sur le bouton  de l'appareil ou de la télécommande pendant le **Nettoyage intégral**, la fonction **Nettoyage intégral** est désactivée.
- Pendant le **Nettoyage intégral**, un bruit de « tic-tac » ou de « tac-tac » peut se faire entendre lorsque l'appareil se dilate ou se contracte.
- Après le **Nettoyage intégral**, l'appareil s'éteint automatiquement. Lorsqu'il est remis sous tension, il fonctionne en mode **Refroidissement**.
- Si la fonction **Minuterie** est activée, la fonction **Nettoyage intégral** risque de ne pas fonctionner correctement.
- De l'air frais sort de la sortie lorsque la fonction **Nettoyage intégral** est activée.
- En cas de connexion à l'unité extérieur Multi, il se peut que ces fonctions ne soient pas prises en charge.

### Gestionnaire kW (sur certains modèles/LG ThinQ)

La consommation électrique du climatiseur est automatiquement ajustée en fonction d'un horaire et d'une consommation électrique cible définis par l'utilisateur.

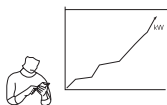

☐ apparaît sur l'écran de l'unité intérieure sur certains modèles.

#### REMARQUE

- Lors de l'utilisation de la fonction **Gestionnaire kW**, le débit d'air froid peut être réduit en fonction de la puissance cible restante.
- Lorsque la consommation d'électricité cible est dépassée, la fonction **Gestionnaire kW** est désactivée.
- Lorsque les modes **Chauffage** et **Automatique** sont utilisés, la fonction **Gestionnaire kW** est désactivée.
- En cas de connexion à l'unité extérieur Multi, il se peut que ces fonctions ne soient pas prises en charge.
- La consommation d'énergie indiquée par l'application **LG ThinQ** peut différer de la consommation d'énergie réelle indiquée sur votre facture d'électricité.
- Les informations relatives à la consommation d'énergie peuvent varier en fonction de l'appareil.
- La consommation d'énergie peut différer des résultats obtenus avec d'autres appareils de mesure.
- La consommation électrique mesurée peut varier en fonction de l'environnement dans lequel l'appareil est installé.
- La consommation d'énergie mesurée peut varier en fonction de l'environnement ou de la méthode d'utilisation de l'appareil domestique.
- Lors du réglage de la durée d'utilisation, l'appareil ne s'allume pas ou ne s'éteint pas automatiquement.
- Même pendant l'utilisation de la fonction **Gestionnaire kW**, la fonction réglée à l'aide de la télécommande est reflétée en premier.
- L'utilisation réelle peut différer.

### Sommeil+ (sur certains modèles/LG ThinQ)



Utilisez ce mode avant de dormir. L'appareil apprend et ajuste automatiquement la température et la vitesse du ventilateur pour créer un environnement de sommeil encore plus personnalisé.

#### REMARQUE

- Cette fonction peut être réglée lorsque l'appareil est sous tension.
- Cette fonction est disponible avec le mode **Refroidissement**.
- En cas de connexion à l'unité extérieur Multi, il se peut que ces fonctions ne soient pas prises en charge.

## CONSEIL UTILE

### Fonctionnement manuel

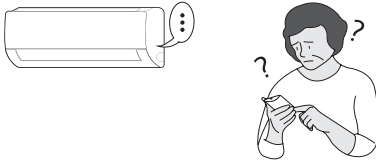

Si votre télécommande sans fil est indisponible, il est possible d'allumer ou d'éteindre l'appareil en appuyant sur le bouton **MARCHE/ARRÊT** ① de l'unité intérieure.

- 1 Ouvrez le volet haut/bas.
- 2 Appuyez sur le bouton **MARCHE/ARRÊT** ①.

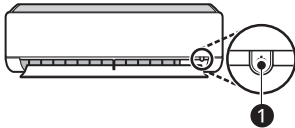

## APERÇU DU PRODUIT

### Montage mural

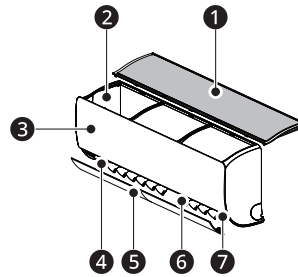

- ① Filtre à air
- ② Évents d'entrée d'air
- ③ Couvercle avant
- ④ Évents de sortie d'air
- ⑤ Déflecteur d'air (volet haut/bas)
- ⑥ Déflecteur d'air (ailettes gauche/droite)
- ⑦ Bouton Marche/arrêt

### REMARQUE

- Le nombre de pièces et leur emplacement peuvent varier en fonction du modèle de l'appareil.
- Les fonctionnalités peuvent varier en fonction du type de modèle.

# ENTRETIEN

## Retrait et remplacement du filtre à air

- 1 Coupez l'alimentation électrique de l'appareil.
- 2 Repérez les boutons du filtre à air situés sur la partie supérieure frontale du produit.

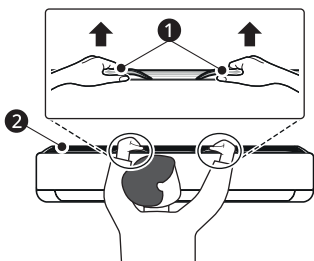

- 1 Boutons
- 2 Filtre à air

- 3 Tirez légèrement les boutons vers le haut, puis soulevez tout le filtre pour le retirer.

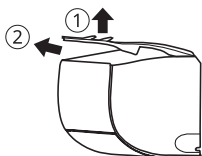

- 4 Insérez les crochets du filtre à air dans les fentes situées derrière le panneau frontal.

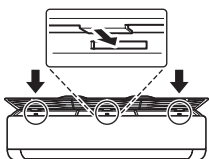

- 5 Abaissez les crochets jusqu'à ce qu'un déclic retentisse, indiquant qu'ils sont en place.

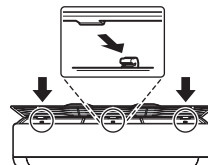

- 6 Pour vous assurer que le filtre est correctement installé, appuyez sur toute sa longueur frontale.

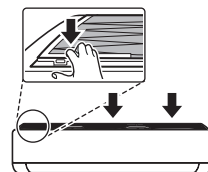

## Nettoyage du filtre à air

- 1 Retirez le filtre à air de l'appareil.
- 2 Nettoyez le filtre à air à l'aide d'un aspirateur ou lavez-le avec de l'eau tiède et un détergent doux.

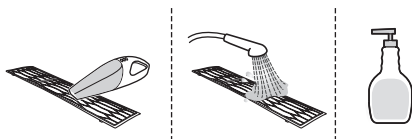

- 3 Laissez sécher le filtre à l'ombre.

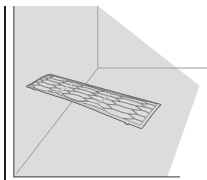

### REMARQUE

- Nettoyez le filtre à air toutes les deux semaines ou plus souvent, si nécessaire.
- Ne pliez pas le filtre à air, car il pourrait se casser.
- Ne faites pas fonctionner l'appareil sans que le filtre soit en place.
- Assemblez correctement le filtre à air, de sorte que ni poussière, ni d'autres substances ne s'infiltreront dans le produit.

# DÉPANNAGE

## Avant d'appeler le réparateur

Veillez vérifier les éléments suivants avant de communiquer avec le centre de service. Si le problème persiste, communiquez avec votre centre de service local.

### Fonction de diagnostic automatique

Cet appareil est équipé d'une fonction de **Diagnostic automatique** intégrée. En cas d'erreur, le voyant de l'appareil intérieur clignote par intervalles de 2 secondes. Si cela se produit, contactez votre revendeur ou centre de service local.

#### L'appareil ne fonctionne pas normalement.

- Une odeur de roussi ou un bruit étrange provient de l'appareil.
- De l'eau s'échappe de l'appareil intérieur même lorsque le niveau d'humidité est faible.
- Le câble d'alimentation est endommagé ou produit une chaleur excessive.
- Un commutateur, un disjoncteur (sécurité, mise à la masse) ou un fusible ne fonctionne pas correctement.
- La fonction de diagnostic automatique de l'appareil génère un code d'erreur.
  - Mettez l'appareil hors tension ou débranchez le câble d'alimentation, puis communiquez avec le centre de service.
- Système de détection de fuite de réfrigérant R32 est activé.
  - En cas de codes d'erreur tels que 228, 229 et 230, aérez la pièce et contactez immédiatement le personnel autorisé.
  - Si le code d'erreur est 236, la durée de vie du détecteur de fuites de réfrigérant est inférieure à 6 mois. Contactez immédiatement le personnel autorisé.

#### La vitesse de ventilation ne peut pas être réglée.

- Le mode Jet ou le mode Fonctionnement automatique est sélectionné.
  - Certains modes de fonctionnement ne permettent pas de régler la vitesse de ventilation. Sélectionnez un mode de fonctionnement qui vous permet de le faire.

#### Il est impossible de régler la température.

- Le mode Ventilateur ou le mode Jet est sélectionné.
  - Certains modes de fonctionnement ne permettent pas de régler la température. Sélectionnez un mode de fonctionnement qui vous permet de le faire.

#### L'appareil ne fonctionne pas.

- L'appareil est débranché.
  - Vérifiez si le cordon d'alimentation est branché dans la prise de courant ou si les isolateurs de courant sont activés.
- Un fusible a sauté ou l'alimentation est coupée.
  - Remplacez le fusible ou vérifiez si le disjoncteur s'est déclenché.
- Une panne d'électricité est survenue.
  - Mettez l'appareil hors tension lorsque survient une panne d'électricité.
  - Lorsque l'alimentation est restaurée, patientez pendant trois minutes, puis remettez l'appareil en marche.

- La tension est trop élevée ou trop faible.
  - Vérifiez si le disjoncteur s'est déclenché.
- L'appareil s'est arrêté automatiquement à une heure prédéfinie.
  - Allumez l'appareil.
- La pile de la télécommande sans fil n'est pas dans le bon sens ou mal insérée.
  - Vérifiez que les piles sont insérées correctement dans la télécommande sans fil.
  - Si les piles sont installées correctement et que l'appareil ne fonctionne toujours pas, remplacez les piles et essayez à nouveau.

### L'appareil ne génère pas d'air frais.

- L'air ne circule pas normalement.
  - Assurez-vous que des rideaux, des stores ou des meubles ne bloquent pas l'avant de l'appareil.
- Le filtre à air est sale.
  - Nettoyez le filtre à air une fois toutes les deux semaines.
  - Consultez la rubrique « **Nettoyage du filtre à air** » pour obtenir plus de renseignements.
- La température ambiante est trop élevée.
  - En été, le refroidissement de tout l'air intérieur peut demander un certain temps. Dans ce cas, sélectionnez le mode **Jet** pour refroidir rapidement l'air intérieur.
- L'air froid s'échappe de la pièce.
  - Assurez-vous qu'il n'y ait pas de fuite d'air froid au niveau des points de ventilation de la pièce.
- La température souhaitée est supérieure à la température actuelle.
  - Réglez la température souhaitée à un niveau inférieur à la température actuelle.
- Une source de chauffage se trouve à proximité du climatiseur.
  - Évitez d'utiliser un générateur de chaleur, comme les fours électriques ou les tables de cuisson, lorsque le climatiseur est en marche.
- Le mode Ventilateur est sélectionné.
  - En mode **Ventilateur**, l'appareil expulse de l'air sans refroidir ou chauffer l'air intérieur.
  - Basculez le mode de fonctionnement sur une opération de refroidissement.

### L'appareil intérieur continue de fonctionner même après avoir été éteint.

- La fonction Nettoyage automatique+ est en cours d'utilisation.
  - Laissez la fonction **Nettoyage automatique+** se poursuivre, car elle permet de réduire l'humidité qui reste dans l'unité intérieure. Si vous ne souhaitez pas utiliser cette fonction, vous pouvez arrêter l'unité intérieure.

### L'appareil ne génère pas d'air chaud.

- Lorsque le mode Chauffage démarre, le volet est presque fermé et aucun air ne sort, même si l'appareil extérieur fonctionne.
  - Cette situation est normale. Veuillez attendre jusqu'à ce que l'appareil ait généré suffisamment d'air chaud pour qu'il sorte de l'appareil.
- L'appareil extérieur est réglé sur le mode Dégivrage.
  - En mode **Chauffage**, de la glace et du givre s'accumulent sur les serpentins lorsque la température extérieure chute. Le mode **Dégivrage** réduit la couche de givre sur les serpentins et se termine en 15 minutes environ.

# ANNEXE

## Renseignements sur l'avis de logiciel libre

Pour obtenir le code source contenu dans ce produit, conformément aux dispositions de la licence publique générale, de la licence publique générale limitée, de la licence publique Mozilla et de toute autre licence régissant les logiciels à code source libre exigeant la divulgation du code source, visitez le site <https://opensource.lge.com>. En plus du code source, toutes les dispositions de licence, les avis de droits d'auteurs et autres documents pertinents peuvent aussi être consultés.

LG Electronics mettra également à votre disposition le code source libre sur CD-ROM pour un prix couvrant le coût de la distribution (coût du support, de l'expédition et de la manutention) sur simple demande par courriel à l'adresse [opensource@lge.com](mailto:opensource@lge.com).

Cette offre est valable pour une période de trois ans après notre dernière expédition de ce produit et s'applique à toute personne ayant reçu ces renseignements.

# GARANTIE LIMITÉE

## CANADA

### CONDITIONS GÉNÉRALES

LES TERMES ET CONDITIONS COMPLÈTES DE LA GARANTIE LIMITÉE DU PRODUIT SE TROUVENT SUR [HTTPS://WWW.LGHVAC.COM](https://www.lghvac.com).

AVIS D'ARBITRAGE : LA PRÉSENTE GARANTIE LIMITÉE CONTIENT UNE DISPOSITION RELATIVE À L'ARBITRAGE STIPULANT QUE VOUS ET LG DEVEZ RÉSOUDRE TOUT DIFFÉREND PAR ARBITRAGE PLUTÔT QUE DEVANT UN TRIBUNAL, À MOINS QUE LES LOIS DE VOTRE PROVINCE OU TERRITOIRE NE LE PERMETTENT PAS OU, DANS LE CAS D'AUTRES JURIDICTIONS, SI VOUS CHOISISSEZ DE VOUS RETIRER. PRÉCISONS QUE CETTE DISPOSITION D'ARBITRAGE N'EST PAS APPLICABLE AUX CLIENTS QUI RÉSIDENT EN ONTARIO. EN ARBITRAGE, LES RECOURS COLLECTIFS ET LES PROCÈS DEVANT JURY NE SONT PAS AUTORISÉS. VEUILLEZ CONSULTER LA SECTION INTITULÉE « PROCÉDURE DE RÈGLEMENT DES DIFFÉRENDS » CI-DESSOUS.

### PROCÉDURE DE RÈGLEMENT DE DIFFÉREND :

SAUF LÀ OÙ LA LOI L'INTERDIT, TOUTS LES DIFFÉRENDS ENTRE VOUS ET LG DÉCOULANT OU SE RAPPORTANT DE QUELQUE MANIÈRE QUE CE SOIT À CETTE GARANTIE LIMITÉE OU AU PRODUIT SERONT RÉSOLUS EXCLUSIVEMENT PAR ARBITRAGE EXÉCUTOIRE, ET NON DEVANT UN TRIBUNAL DE DROIT COMMUN. SAUF LÀ OÙ LA LOI L'INTERDIT, VOUS ET LG RENONCEZ IRRÉVOCABLEMENT AU DROIT À UN PROCÈS DEVANT JURY ET À INTENTER OU À PARTICIPER À UN RECOURS COLLECTIF. PRÉCISONS QUE CETTE DISPOSITION NE S'APPLIQUE PAS AUX CONSOMMATEURS QUI RÉSIDENT EN ONTARIO.

**Définitions.** Aux fins du présent article, « LG » désigne LG Electronics Canada Inc., ses sociétés mères, ses filiales et ses sociétés affiliées et tous leurs dirigeants, administrateurs, employés, agents, bénéficiaires, détenteurs précédents des mêmes droits, successeurs, cessionnaires et fournisseurs; « différend » et « réclamation » englobent tout différend, toute réclamation ou tout litige de quelque sorte que ce soit (fondés sur une responsabilité contractuelle, délictuelle, légale, réglementaire ou découlant d'une ordonnance, par fraude, fausse représentation ou sous quelque régime de responsabilité que ce soit) découlant de quelque façon que ce soit de la vente, des conditions ou de l'exécution du produit ou de la présente garantie limitée.

**Avis de différend.** Si vous prévoyez engager une procédure d'arbitrage, vous devez d'abord envoyer à LG un préavis écrit d'au moins 30 jours à l'adresse suivante : Équipe juridique LGEC1, 20 Norelco Drive, North York, Ontario, Canada M9L 2X6 (l'« avis de différend »). Vous et LG convenez de discuter en toute bonne foi pour tenter de régler le différend à l'amiable. L'avis doit mentionner votre nom, votre adresse, votre numéro de téléphone, le produit faisant l'objet de la réclamation, la nature de la réclamation et la réparation demandée. Si vous et LG ne parvenez pas à régler le différend dans les 30 jours suivant la réception de l'avis de différend par LG, le différend doit être réglé par arbitrage exécutoire conformément à la procédure établie aux présentes. Vous et LG convenez que, tout au long du processus d'arbitrage, les modalités (y compris les montants) de toute offre de règlement formulée par vous ou par LG ne seront pas divulguées à l'arbitre, jusqu'à ce que l'arbitre règle le différend.

## 16 GARANTIE LIMITÉE

**Accord sur l'arbitrage exécutoire et renonciation à un recours collectif.** À défaut de résoudre le différend au cours de la période de 30 jours suivant la réception par LG de l'avis de différend, vous et LG acceptez de résoudre toute réclamation entre vous et LG uniquement par arbitrage exécutoire sur une base individuelle, à moins que vous choisissiez de vous retirer, comme il est indiqué ci-dessous, ou que vous résidiez dans une province ou un territoire qui empêche la pleine application de cette clause dans les circonstances des réclamations en question (dans ce cas, si vous êtes un consommateur, cette clause ne s'appliquera que si vous acceptez expressément l'arbitrage). Dans la mesure permise par la loi applicable, tout différend entre vous et LG ne doit pas être combiné ou consolidé avec un différend impliquant le produit ou la réclamation de toute autre personne ou entité. Plus précisément, sans limitation de ce qui précède, sauf dans la mesure où une telle interdiction n'est pas permise par la loi, tout différend entre vous et LG ne pourra en aucun cas se poursuivre sous forme de recours collectif ou d'action dérivée. Au lieu de l'arbitrage, l'une ou l'autre des parties peut tenter une demande en justice auprès de la Cour des petites créances, mais cette demande auprès de la Cour des petites créances ne peut être intentée sous forme de recours collectif ou d'action dérivée, sauf dans la mesure où une telle interdiction n'est pas autorisée par la loi dans votre province ou territoire de compétence pour une réclamation en cause entre vous et LG. Cette disposition ne s'applique pas aux consommateurs de l'Ontario. Conformément à la législation provinciale, le consommateur et LG peuvent convenir de résoudre le litige en utilisant toute procédure disponible, y compris l'amorce d'une action devant la Cour supérieure de justice.

**Règles et procédures d'arbitrage.** Pour engager l'arbitrage d'une réclamation, une demande écrite d'arbitrage doit être soumise par vous ou LG. L'arbitrage sera privé et confidentiel, et se déroulera sur une base simplifiée et accélérée devant un arbitre unique choisi par les parties en vertu de la loi et des règles provinciales ou territoriales sur l'arbitrage commercial de la province ou du territoire où vous résidez. Vous devez également envoyer une copie de votre demande écrite à LG à l'adresse LG Electronics, Canada, Inc., Attn: Legal Department- Arbitration, 20, Norelco Drive, North York (Ontario), M9L 2X6. Cette disposition relative à l'arbitrage est régie par la législation provinciale ou territoriale applicable en matière d'arbitrage commercial. Pour les consommateurs de l'Ontario, la législation applicable en matière d'arbitrage ne s'applique que si les consommateurs acceptent de soumettre le litige à l'arbitrage. Un jugement peut être rendu sur décision de l'arbitre devant tout tribunal compétent. Toute question doit être tranchée par l'arbitre, à l'exception des questions relatives à la portée et à l'applicabilité de la disposition relative à l'arbitrage et à l'arbitrabilité du différend, qui doivent être tranchées par la cour. L'arbitre est lié par les modalités de cette disposition.

**Droit applicable.** Les lois de votre province ou territoire d'achat régissent la présente garantie limitée et tout différend entre vous et LG, sauf dans la mesure où de telles lois sont supplantées par des lois fédérales, provinciales ou territoriales applicables ou sont incompatibles avec ces dernières. Si l'arbitrage n'est pas autorisé pour régler une réclamation, une poursuite, un différend ou un litige entre vous et LG, vous et LG vous en remettez à la compétence exclusive des tribunaux de votre province ou territoire d'achat pour le règlement de la réclamation, de la poursuite, du différend ou du litige entre vous et LG.

**Frais et coûts.** Aucuns frais ne sont exigibles pour entamer une procédure d'arbitrage. À la réception de votre demande d'arbitrage écrite, LG règlera rapidement la totalité des frais de dépôt de la demande d'arbitrage, sauf si vous réclamez des dommages-intérêts supérieurs à 25 000 \$. Dans ce cas, le paiement de ces frais sera régi par les règles d'arbitrage applicables. Sauf disposition contraire aux présentes, LG paiera tous les frais de dépôt de demande et d'administration ainsi que les honoraires de l'arbitre conformément aux règles d'arbitrage applicables et à la présente disposition sur l'arbitrage. Si vous remportez l'arbitrage, LG règlera vos frais et honoraires juridiques après avoir déterminé s'ils sont raisonnables en se fondant sur des facteurs comme, entre autres, le montant de l'achat et le montant de la réclamation. Si l'arbitre juge que le motif de la réclamation ou les réparations demandées sont futiles ou se fondent sur des motifs déplacés (au regard des lois applicables), le paiement de tous les frais d'arbitrage sera régi par les règles d'arbitrage applicables. Dans un tel cas, vous acceptez de rembourser à LG la totalité des montants versés qu'il vous revient autrement de payer en vertu des règles d'arbitrage applicables. Sauf disposition contraire et si elle remporte l'arbitrage, LG renonce à tous ses droits de vous réclamer des frais et honoraires juridiques.

**Audience et lieu de l'arbitrage.** Si votre réclamation est égale ou inférieure à 25 000 \$, vous pouvez opter pour un arbitrage conduit selon l'une des modalités suivantes uniquement : 1) sur examen des documents remis à l'arbitre, 2) par audience téléphonique ou 3) par audience en personne selon les dispositions des règles d'arbitrage applicables. Si votre réclamation dépasse 25 000 \$, le droit à une audience sera défini par les règles d'arbitrage applicables. Les audiences arbitrales en personne se tiendront à l'endroit le plus proche et le plus pratique pour les deux parties situé dans votre province ou votre territoire de résidence, sauf si vous et LG convenez mutuellement d'un autre lieu ou d'un arbitrage par téléphone.

**Dissociabilité et renoncement.** Si une partie de la présente garantie limitée (y compris les présentes procédures d'arbitrage) n'est pas applicable, les dispositions restantes demeurent en vigueur dans toute la mesure permise par la loi applicable. Le fait de ne pas exiger la stricte exécution d'une disposition de la présente garantie limitée (y compris les présentes procédures d'arbitrage) ne signifie pas que LG renonce ou a l'intention de renoncer à toute disposition ou partie de la présente garantie limitée.

**Option de retrait.** La disposition d'arbitrage stipule que vous et LG devez résoudre tout différend par arbitrage exécutoire plutôt que devant un tribunal, à moins que les lois de votre province ou territoire ne le permettent pas, ou, dans le cas d'autres systèmes juridiques, si vous choisissez de vous retirer. Cette disposition d'arbitrage ne s'applique pas aux consommateurs de l'Ontario. Pour les personnes qui relèvent des dispositions relatives à l'arbitrage obligatoire, vous pouvez choisir de vous retirer de la présente procédure de résolution des différends. Si vous choisissez de vous retirer, ni vous ni LG ne pouvez obliger l'autre partie à participer à une procédure d'arbitrage. Pour vous retirer, vous devez envoyer un avis à LG dans les 30 jours civils à compter de la date d'achat du produit par le premier acheteur (i) en envoyant un courriel à [optout@lge.com](mailto:optout@lge.com) avec pour objet : « Retrait de l'arbitrage » ou (ii) en composant le 1-800-980-2973. Vous devez indiquer dans le courriel de retrait ou fournir par téléphone : (a) votre nom et adresse; (b) la date à laquelle le produit a été acheté; (c) le nom de modèle du produit ou le numéro de modèle; et (d) le numéro de série (le numéro de série se trouve (i) sur le produit ou (ii) en ligne en vous rendant au [https://www.lg.com/ca\\_en/findmodel\\_serial/](https://www.lg.com/ca_en/findmodel_serial/)).

Si vous vous prévaliez de l'option de retrait, les lois de votre province ou territoire de résidence régissent la présente garantie limitée et tout différend entre vous et LG, sauf dans la mesure où de telles lois sont supplantées par des lois fédérales, provinciales ou territoriales applicables ou sont incompatibles avec ces dernières. Si l'arbitrage n'est pas autorisé pour régler une réclamation, une poursuite, un différend ou un litige entre vous et LG, vous et LG vous en remettez à la compétence exclusive des tribunaux de votre province ou territoire de résidence pour le règlement de la réclamation, de la poursuite, du différend ou du litige entre vous et LG.

Vous ne pouvez vous prévaloir de l'option de retrait que de la manière décrite ci-dessus (c'est-à-dire par courriel ou par téléphone). Aucun autre type d'avis ne sera pris en compte pour le retrait de la présente procédure de règlement de différend. Le fait de se retirer de la présente procédure de règlement de différend ne compromet en aucune façon la protection accordée en vertu de la garantie limitée, et vous continuerez à jouir de tous les avantages prévus par la garantie limitée. Si vous conservez ce produit sans vous prévaloir de l'option de retrait, vous acceptez alors les conditions générales de la disposition sur l'arbitrage énoncée ci-dessus.

**Conflit de modalités.** En cas de conflit ou d'incompatibilité entre les modalités de la présente garantie limitée et le contrat de licence d'utilisation (« CLU ») en ce qui concerne le règlement des différends, les modalités de la présente garantie limitée contrôlent et régissent les droits et obligations des parties et ont préséance sur le CLU.

## 18 AIDE-MÉMOIRE

---



MANUAL DEL PROPIETARIO

# AIRE ACONDICIONADO

---

Lisez d'abord entièrement les CONSIGNES DE SÉCURITÉ  
IMPORTANTES.

Para utilizar el producto con seguridad y comodidad, lea el manual de  
instrucciones antes de utilizarlo.

**ESPAÑOL**

TIPO: MONTADO EN LA PARED

K\*UAB\*\*1A, K\*UAK\*\*1A, KNMAB\*\*1A

[www.lghvac.com](http://www.lghvac.com)

[www.lg.com](http://www.lg.com)

Copyright © 2024 LG Electronics. Todos los derechos reservados

## ÍNDICE

### 3 FUNCIONAMIENTO

---

- 3 VER MÁS INFORMACIÓN
- 3 Instalación de la aplicación LG ThinQ y conexión de un electrodoméstico LG (en algunos modelos)
- 4 CONTROL REMOTO INALÁMBRICO
- 7 NUEVAS FUNCIONES
- 9 CONSEJO ÚTIL

### 9 DESCRIPCIÓN GENERAL DEL PRODUCTO

---

- 9 Montado a la pared

### 10 MANTENIMIENTO

---

- 10 Eliminación y reemplazo del filtro de aire
- 11 Limpieza del filtro de aire

### 12 SOLUCIÓN DE PROBLEMAS

---

- 12 Antes de llamar al servicio técnico

### 14 APÉNDICE

---

- 14 Software de código abierto

### 15 GARANTÍA LIMITADA

---

- 15 EE. UU.

# FUNCIONAMIENTO

## VER MÁS INFORMACIÓN

- 1 Se revisó el nombre del modelo en la etiqueta.

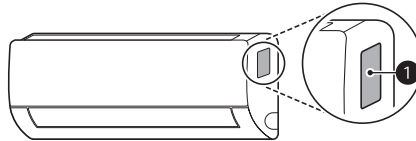

- 1 Etiqueta

- 2 Buscando el nombre del modelo en [www.lg.com](http://www.lg.com).

### NOTA

- La imagen podría variar dependiendo del producto.

## Instalación de la aplicación LG ThinQ y conexión de un electrodoméstico LG (en algunos modelos)

### NOTA

- Esta característica solo está disponible en modelos con Wi-Fi.

### Modelos con código QR

Escanee el código QR adjunto al producto utilizando la cámara o una aplicación lectora de códigos QR de su smartphone.

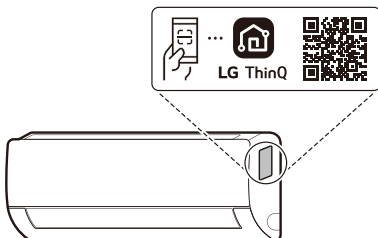

### Modelos sin código QR

Busque la aplicación **LG ThinQ** en la tienda Google Play o App Store e instálela en su teléfono inteligente.

Ejecute la aplicación **LG ThinQ** e inicie sesión con su cuenta existente o cree una cuenta LG para iniciar sesión.

Toque el botón para agregar (+) de la aplicación **LG ThinQ** para conectar su electrodoméstico LG. Siga las instrucciones de la aplicación para completar el proceso.

## 4 FUNCIONAMIENTO

# CONTROL REMOTO INALÁMBRICO





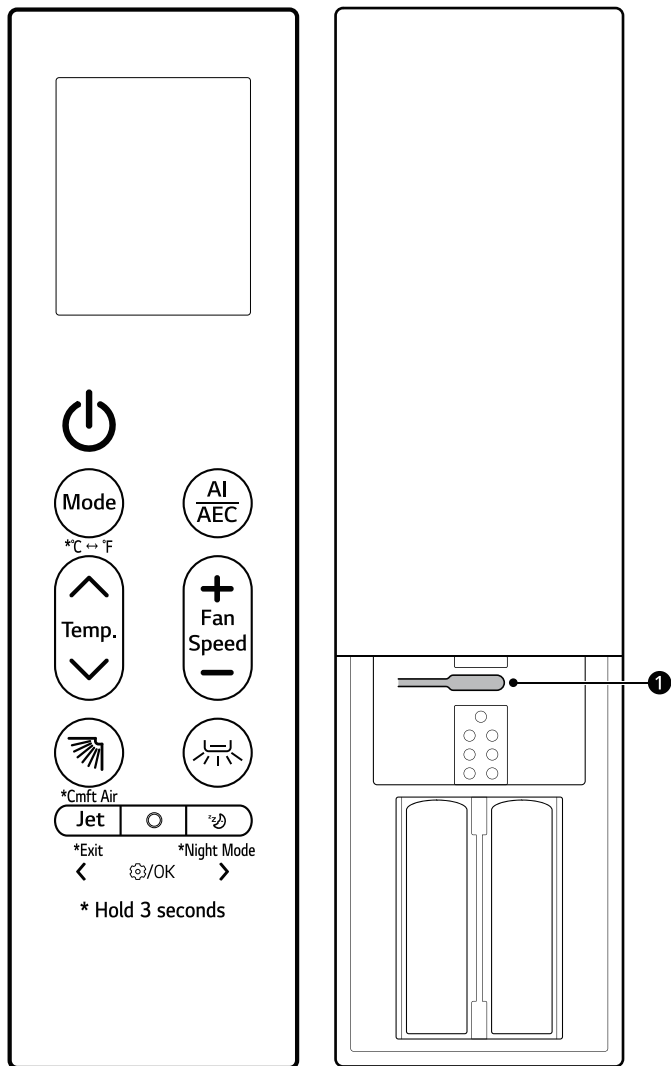

Puede operar el electrodoméstico con mayor comodidad utilizando el control remoto inalámbrico.

Para obtener instrucciones más detalladas, consulte el manual web.



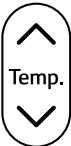





### NOTA

- De acuerdo con el modelo, es posible que algunas funciones no sean compatibles.

Imagen	Descripción
	<p><b>Encendido</b> Enciende o apaga el electrodoméstico.</p>
	<p><b>Conexión con LG ThinQ</b> Mantenga presionado el botón <b>Encendido</b> por unos 3 segundos para preparar la conexión del electrodoméstico y Wi-Fi.</p>
	<p><b>Mode</b> Selecciona el modo de funcionamiento que desee.</p> <ul style="list-style-type: none"> <li>Cada pulsación cambia los modos en el siguiente orden: <b>Refrigeración</b> → <b>Automático</b> → <b>Deshumidificación</b> → <b>Calefacción</b> → <b>Ventilador</b></li> </ul> <p>°C ↔ °F</p> <p>Mantenga pulsado el botón <b>Mode</b> por 3 segundos aproximadamente para cambiar las unidades entre °C y °F</p>
	<p><b>AI/AEC</b> Seleccione <b>AI Smart Care</b> o <b>Control de energía activa</b> para disminuir la entrada de corriente eléctrica.</p> <p><b>NOTA</b></p> <ul style="list-style-type: none"> <li>Cuando está conectado a la unidad exterior Multi, <b>Control de energía activa</b> función podría no ser compatible.</li> </ul>
	<p><b>Temperatura ▲, ▼</b> Ajusta la temperatura de ambiente deseada.</p>
	<p><b>Fan Speed +, -</b> Ajusta la velocidad del ventilador.</p>
	<p> <b>(Barrido arriba-abajo)</b> Ajusta la dirección del flujo de aire hacia arriba o hacia abajo.</p> <p><b>Cmft Air</b> Mantenga presionado el botón  por unos 3 segundos para ajustar la dirección del flujo de aire. Esto le ayudará a minimizar el contacto directo con el fujo de aire.</p>

## 6 FUNCIONAMIENTO

Imagen	Descripción
	<b>↔ (Barrido izquierda-derecha)</b> Ajusta la dirección del flujo de aire hacia la izquierda y hacia la derecha.
	<b>Jet</b> Cambia la temperatura de la habitación rápidamente. <b>Exit</b> Al establecer los ajustes, mantenga presionado el botón <b>Jet</b> por unos 3 segundos para regresar al ajuste anterior.
 	<b>Función</b> Selecciona la función deseada. <b>NOTA</b> <ul style="list-style-type: none"><li>• Cuando está conectado a la unidad exterior Multi, <b>Calefacción de ambiente baja</b> función podría no ser compatible.</li></ul>
	<b>☾ (Sueño)</b> Apaga automáticamente el electrodoméstico a la hora deseada. Úselo antes de dormir. <b>Night Mode</b> Mantenga pulsado el botón ☾ por unos 3 segundos para apagar la pantalla y el sonido de bip.
	<b>1 Restablecer</b> Restablece la configuración del control remoto inalámbrico.

## NUEVAS FUNCIONES

### Limpieza total (En algunos modelos/LG ThinQ)

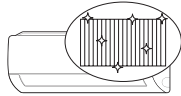

Al congelar y descongelar repetidamente el intercambiador de calor del aire acondicionado, se arrastran contaminantes como el polvo y el electrodoméstico se mantiene limpio.

Luego de la limpieza, reduce la humedad dentro de la unidad interior.

En algunas unidades interiores, **RiL** aparece en la pantalla de la unidad interior.

#### NOTA

- La función **Limpieza total** finalizará cuando el electrodoméstico se haya secado.
- Si la humedad de la habitación es alta cuando la función **Limpieza total** está en funcionamiento, el área cercana a la unidad interior podría empañarse.
- La función **Limpieza total** puede ser usada en interiores desde 70 °F (21 °C) a 90 °F (32 °C) y en exteriores desde 70 °F (21 °C) a 99 °F (37 °C). La función **Limpieza total** es una función de gestión de la higiene, y no una función de refrigeración, por lo que las condiciones de uso podrían variar comparadas con el rango de funcionamiento verificado del electrodoméstico.
- Si la función **Limpieza total** se hace funcionar a una temperatura fuera del rango permisible, la función y las alarmas de la aplicación **LG ThinQ** no funcionarán.
- La función **Limpieza total** está disponible incluso cuando el electrodoméstico está en funcionamiento.
- Si presiona el botón **⏻** en el electrodoméstico o el control remoto durante **Limpieza total**, la función **Limpieza total** se desactiva.
- Durante la **Limpieza total**, un ruido de "tick-tick-" o "tack-tack" podría oírse al expandirse o contraerse el electrodoméstico.
- Después de la **Limpieza total**, el electrodoméstico se apagará automáticamente. Cuando se enciende de nuevo, funcionará en el modo **Refrigeración**.
- Si la función **Temporizador** se establece, la función **Limpieza total** podría no funcionar adecuadamente.
- La salida emite aire frío cuando la función **Limpieza total** se activa.
- Cuando está conectado a la unidad exterior Multi, esta función podría no ser compatible.

### Gerente de KW (En algunos modelos/LG ThinQ)

El consumo de energía del aire acondicionado se ajusta automáticamente en base a una programación y un consumo de energía objetivo establecido por el usuario.

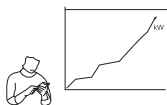

☐ aparece en la pantalla de la unidad interior en algunos modelos.

#### NOTA

- Cuando se usa la función **Gerente de KW**, la producción de aire frío podría reducirse, dependiendo de la cantidad de energía objetivo remanente.
- Cuando el consumo de electricidad objetivo se excede, la función **Gerente de KW** se deshabilita.
- Cuando se usan los modos **Calefacción y Automático**, la función **Gerente de KW** se deshabilita.
- Cuando está conectado a la unidad exterior Multi, esta función podría no ser compatible.
- El consumo de energía que se muestra a través de la aplicación **LG ThinQ** podría diferir del consumo de energía real que se muestre en su factura de electricidad.
- La información sobre el consumo de energía podría variar dependiendo del electrodoméstico.
- El consumo de energía podría diferir de los resultados medidos usando otros dispositivos de medición.
- Dependiendo del entorno en el que se instale el dispositivo, el consumo de energía medido podría variar.
- El consumo de energía medido podría variar dependiendo del entorno de consumo o el método de consumo del electrodoméstico.
- Al establecer el tiempo de uso, el electrodoméstico no se enciende o apaga automáticamente.
- Incluso durante el funcionamiento de la función **Gerente de KW**, la función establecida con el control remoto se refleja en primer lugar.
- El consumo real podría ser diferente.

### Sueño+ (En algunos modelos/LG ThinQ)



Usar antes de ir a dormir. El electrodoméstico aprenderá automáticamente y cambiará la temperatura y la velocidad del ventilador para crear un entorno incluso más personalizado durante el sueño.

#### NOTA

- Esta función puede configurarse cuando el electrodoméstico está encendido.
- Esta función está disponible en el modo **Enfriamiento**.
- Cuando está conectado a la unidad exterior Multi, esta función podría no ser compatible.

## CONSEJO ÚTIL

### Funcionamiento manual

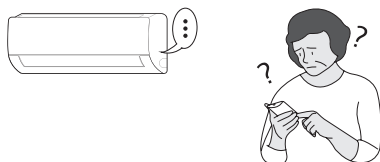

Si su control remoto inalámbrico no está disponible, puede encender o apagar el electrodoméstico con el botón **ENCENDIDO** ① en la unidad interior.

- 1 Abra el deflector ascendente-descendente.
- 2 Pulse el botón de **Encendido** ①.

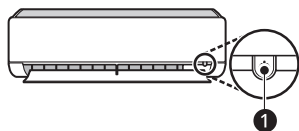

## DESCRIPCIÓN GENERAL DEL PRODUCTO

### Montado a la pared

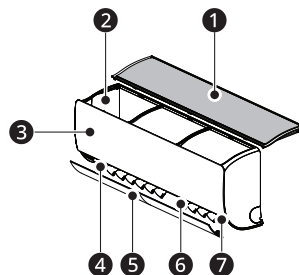

- ① Filtro de aire
- ② Conductos de entrada de aire
- ③ Cubierta delantera
- ④ Conductos de salida de aire
- ⑤ Deflector de aire (aleta ascendente-descendente)
- ⑥ Deflector de aire (rejilla izquierda y derecha)
- ⑦ Botón de encendido

### NOTA

- El número y la ubicación de las piezas pueden variar según el modelo de electrodoméstico.
- Las características pueden variar según el tipo de modelo.

# MANTENIMIENTO

## Eliminación y reemplazo del filtro de aire

- 1 Desconecte la electricidad del electrodoméstico.
- 2 Coloque las perillas del filtro de aire en la parte superior delantera del producto.

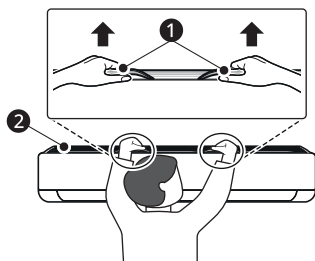

- 1 Perillas
- 2 Filtro de aire

- 3 Tire ligeramente hacia arriba de las perillas y, a continuación, levante el filtro completo para retirarlo.

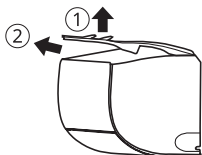

- 4 Inserte los ganchos en las ranuras de la parte trasera del panel delantero del filtro de aire.

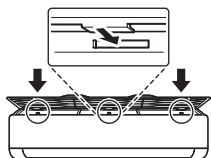

- 5 Tire de los ganchos hacia abajo hasta que encajen en su sitio.

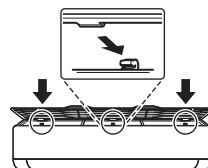

- 6 Para asegurarse de que el filtro esté montado correctamente, presione hacia abajo a lo largo de toda la parte delantera del filtro.

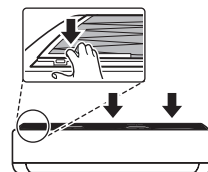

## Limpieza del filtro de aire

- 1 Retire el filtro de aire del electrodoméstico.
- 2 Limpie el filtro con una aspiradora o con agua tibia con detergente neutro.

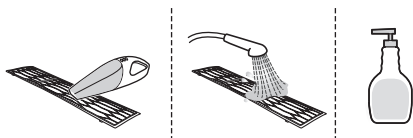

- 3 Deje secar el filtro a la sombra.

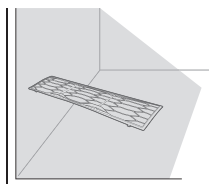

### NOTA

- Limpie los filtros de aire cada 2 semanas o con más frecuencia si es necesario.
- No doble el filtro de aire, ya que se puede romper.
- No haga funcionar el electrodoméstico sin el filtro en su lugar.
- Monte el filtro de aire correctamente para evitar que el polvo y otras sustancias entren en el producto.

# SOLUCIÓN DE PROBLEMAS

## Antes de llamar al servicio técnico

Verifique lo siguiente antes de comunicarse con el centro de servicio. Si el problema persiste, póngase en contacto con el centro de servicio local.

## Función de autodiagnóstico

Este electrodoméstico tiene incorporada una función de **Autodiagnóstico**. Si se produce un error, la luz de la unidad interior parpadeará en intervalos de 2 segundos. Si esto ocurre, póngase en contacto con su distribuidor o centro de servicio local.

### El electrodoméstico no funciona normalmente.

- La unidad emite olor a quemado y ruidos extraños.
- Sale agua de la unidad interior, incluso cuando el nivel de humedad es bajo.
- El cable de alimentación está dañado o genera un calor excesivo.
- Un interruptor, un disyuntor (de seguridad o a tierra) o un fusible no funciona correctamente.
- La unidad genera un código de error a partir del autodiagnóstico.
  - Apague el electrodoméstico, apague o desconecte el suministro de electricidad y comuníquese con el centro de servicio técnico.
- Se activa un sistema de detección de fugas de refrigerante R32.
  - Si aparecen códigos de error como 228, 229 y 230, ventile la habitación y póngase en contacto con el personal autorizado inmediatamente.
  - Si hay un código de error de 236, el detector de fugas de refrigerante dispone de una vida útil de menos de 6 meses. Póngase en contacto con personal autorizado inmediatamente.

### No se puede ajustar la velocidad del ventilador.

- Está seleccionado el modo Alta potencia o el modo Funcionamiento automático.
  - En algunos modos de funcionamiento, no se puede ajustar la velocidad del ventilador. Seleccione un modo de funcionamiento en el que se pueda ajustar la velocidad del ventilador.

### No se puede ajustar la temperatura.

- Está seleccionado el modo Alta potencia o el modo Ventilador.
  - En algunos modos de funcionamiento, no es posible ajustar la temperatura. Seleccione un modo de funcionamiento en el que se pueda ajustar la temperatura.

### El electrodoméstico no funciona.

- El electrodoméstico está desenchufado.
  - Compruebe que el cable de alimentación esté enchufado al tomacorriente y que los interruptores estén encendidos.
- Un fusible se fundió o el suministro de electricidad está bloqueado.
  - Reemplace el fusible o compruebe si no se activó el disyuntor.
- Se ha producido una falla en el suministro eléctrico.
  - Apague el electrodoméstico cuando se produzca un corte de energía.
  - Cuando vuelva la electricidad, espere tres minutos y luego vuelva a encenderlo.

- El voltaje es demasiado alto o demasiado bajo.
  - Compruebe si se activó el disyuntor.
- El electrodoméstico se apagó automáticamente a una hora predeterminada.
  - Encienda el electrodoméstico.
- La configuración de las baterías es incorrecta en el control remoto inalámbrico.
  - Asegúrese de que las baterías estén colocadas correctamente en el control remoto inalámbrico.
  - Si las baterías están colocadas correctamente y el electrodoméstico sigue sin funcionar, reemplace las baterías y vuelva a intentarlo.

#### El electrodoméstico no emite aire frío.

- El aire no circula correctamente.
  - Asegúrese de que no haya cortinas, persianas ni muebles que bloqueen el frente del electrodoméstico.
- El filtro de aire está sucio.
  - Limpie el filtro de aire cada dos semanas.
  - Para obtener más información, consulte la sección “**Limpieza del filtro de aire**”.
- La temperatura de la habitación es demasiado alta.
  - En verano, enfriar totalmente el aire del interior puede demorar. En este caso, seleccione el modo **Alta potencia** para enfriar el aire del interior rápidamente.
- El aire frío se escapa de la habitación.
  - Asegúrese de que el aire frío no se escape a través de los puntos de ventilación de la habitación.
- La temperatura deseada es mayor que la temperatura actual.
  - Configure la temperatura deseada en un nivel inferior que la temperatura actual.
- Hay una fuente de calor en las cercanías.
  - Evite el uso de generadores de calor, como hornos eléctricos o estufas de gas, mientras el aire acondicionado está en funcionamiento.
- Está seleccionado el modo Ventilador.
  - En el modo **Ventilador**, el aire sale del electrodoméstico sin refrigerar o calentar el aire interior.
  - Cambie el modo de operación a Enfriamiento.

#### La unidad interior sigue funcionando incluso cuando se ha apagado el electrodoméstico.

- Se está ejecutando la función Limpieza automática+.
  - Permita que la función **Limpieza automática+** continúe, ya que elimina cualquier resto de humedad dentro de la unidad interior. Si no desea que se ejecute esta función, puede apagar la unidad interior.

#### El electrodoméstico no emite aire caliente.

- Cuando se inicia el modo Calefacción, el deflector está casi cerrado y no sale aire, a pesar de que la unidad exterior está en funcionamiento.
  - Esto es normal. Espere hasta que la unidad haya generado suficiente aire caliente como para soplarlo a través de la unidad interior.
- La unidad exterior está en modo Descongelamiento.
  - En el modo **Calefacción**, cuando la temperatura exterior baja, se genera hielo/escarcha en las serpentinas. La función **Descongelamiento** elimina la capa de escarcha de la serpentina y debe terminar en aproximadamente 15 minutos.

# APÉNDICE

## Software de código abierto

Para obtener el código fuente bajo GPL, LGPL, MPL y otras licencias de código abierto que tienen la obligación de divulgar el código fuente, que está contenido en este producto, y para acceder a todos los términos de la licencia, avisos sobre derechos de autor y otros documentos relevantes, visite <https://opensource.lge.com>.

LG Electronics también le proporcionará el código abierto en un CD-ROM por un costo que cubra los gastos de dicha distribución (como el costo del medio, del envío y de la manipulación) una vez realizado el pedido por correo electrónico a la dirección [opensource@lge.com](mailto:opensource@lge.com).

Esta oferta es válida para todo aquel que reciba esta información durante un período de tres años después de que se envíe el último cargamento de este producto.

# GARANTÍA LIMITADA

## EE. UU.

### TÉRMINOS Y CONDICIONES

AVISO DE ARBITRAJE: ESTA GARANTÍA LIMITADA CONTIENE UNA DISPOSICIÓN DE ARBITRAJE QUE EXIGE QUE USTED Y LG ELECTRONICS ("LG" DE AQUÍ EN ADELANTE) RESUELVAN LOS CONFLICTOS MEDIANTE UN ARBITRAJE VINCULANTE EN LUGAR DE HACERLO ANTE TRIBUNALES, A MENOS QUE DECIDA NO PARTICIPAR. EN EL ARBITRAJE, LAS DEMANDAS COLECTIVAS Y LOS JUICIOS POR JURADOS NO ESTÁN PERMITIDOS. CONSULTE LA SECCIÓN TITULADA "PROCEDIMIENTO PARA RESOLVER CONFLICTOS" A CONTINUACIÓN.

### PROCEDIMIENTO PARA RESOLVER CONFLICTOS:

TODOS LOS CONFLICTOS ENTRE USTED Y LG QUE SURJAN EN RELACIÓN CON ESTA GARANTÍA LIMITADA O CON EL PRODUCTO SE RESOLVERÁN EXCLUSIVAMENTE A TRAVÉS DE UN ARBITRAJE VINCULANTE Y NO ANTE UN TRIBUNAL DE JURISDICCIÓN GENERAL. "ARBITRAJE VINCULANTE" SIGNIFICA QUE USTED Y LG RENUNCIAN AL DERECHO DE UN JUICIO CON JURADO Y A REALIZAR O PARTICIPAR EN UNA DEMANDA COLECTIVA.

**Definiciones.** Para el propósito de esta sección, las referencias a "LG" significan: LG Electronics U.S.A., Inc., sus empresas matrices, subsidiarias y filiales y cada uno de sus directivos, directores, empleados, agentes, beneficiarios, predecesores en interés, sucesores, cesionarios y proveedores; las referencias a "conflicto" o "reclamo" incluirán cualquier conflicto, reclamo o controversia de cualquier tipo (ya sea basado en contrato, agravio, estatuto, regulación, ordenanza, fraude, falsa representación o cualquier teoría legal o equitativa) que esté relacionada con cualquier forma de venta, condición o rendimiento del producto o de esta Garantía limitada.

**Aviso de conflicto.** En caso de que usted desee iniciar un procedimiento de arbitraje, primero debe notificar a LG por escrito al menos 30 días antes de iniciar el arbitraje; este aviso se presentará por carta a LG y se enviará a LG Electronics, USA, Inc., a la atención de Legal Department- Arbitration 111 Sylvan Avenue, Englewood Cliffs, NJ 07632. Usted y LG aceptan participar en discusiones de buena fe en un intento de resolver su reclamo de manera amistosa. En la carta debe indicar su nombre, dirección y número de teléfono, identificar el producto objeto del reclamo, y describir la naturaleza del reclamo y la solución que busca. Si usted y LG no pueden resolver el conflicto en un plazo de 30 días, cualquiera de las partes puede proceder a presentar una demanda de arbitraje.

**Acuerdo de arbitraje vinculante y renuncia de demanda colectiva.** En caso de no resolver el conflicto durante el período de 30 días después de enviar una notificación por escrito a LG, usted y LG se comprometen a resolver cualquier reclamo solamente a través de arbitraje vinculante sobre una base individual, a menos que usted se excluya, conforme a lo dispuesto a continuación. Cualquier conflicto entre usted y LG no se combinará ni consolidará con un conflicto relacionado con cualquier otro producto o reclamo de otra persona o entidad. Específicamente y sin perjuicio de lo anterior, no procederá bajo ninguna circunstancia cualquier conflicto entre usted y LG como parte de una demanda colectiva o representativa. En lugar del arbitraje, cualquiera de las partes podrá iniciar una acción individual ante un tribunal de reclamos menores, pero tales acciones en el tribunal de reclamos menores no podrán tomarse en una demanda colectiva o representativa.

## 16 GARANTÍA LIMITADA

**Normas y procedimientos de arbitraje.** Para comenzar con el arbitraje de un reclamo, usted o LG deben presentar una demanda escrita para arbitraje. El arbitraje será administrado por la Asociación Americana de Arbitraje (AAA) y se llevará a cabo ante un árbitro único de conformidad con las Normas de Arbitraje del Consumidor de la AAA, que tienen efecto al momento de inicio del arbitraje (en adelante, las "Normas de la AAA") y según los procedimientos establecidos en esta sección. Las Normas de la AAA están disponibles en línea en [www.adr.org/consumer](http://www.adr.org/consumer). Envíe una copia de su solicitud de arbitraje por escrito, así como una copia de esta disposición, a la AAA de la forma descrita en las Normas de la AAA. También debe enviar una copia de su solicitud por escrito a LG en LG Electronics, USA, Inc., a la atención de Legal Department- Arbitration 111 Sylvan Avenue, Englewood Cliffs, NJ 07632. Si hay un conflicto entre las Normas de la AAA y las reglas establecidas en esta sección, prevalecerán las reglas de esta sección. Esta disposición de arbitraje se rige por la Ley Federal de Arbitraje. El juicio se puede introducir en el laudo arbitral en cualquier tribunal de jurisdicción competente. El árbitro tomará su decisión en todas las cuestiones, excepto aquellos asuntos relativos al alcance y aplicabilidad de la cláusula de arbitraje y de la capacidad de arbitraje del conflicto para que el tribunal determine. El árbitro se regirá por los términos de esta disposición.

**Legislación vigente.** La legislación del estado de su residencia regirá esta Garantía limitada, así como todos los conflictos entre nosotros, salvo que sea invalidada o incoherente con leyes federales aplicables.

**Tarifas/costos.** No debe pagar ninguna tarifa para iniciar un arbitraje. Al recibir su solicitud de arbitraje por escrito, LG pagará todos los gastos administrativos rápidamente a la AAA, a menos que usted solicite más de \$25.000,00 por daños, en cuyo caso el pago de estos gastos se regirá por las Normas de la AAA. Salvo disposición contraria prevista en el presente documento, LG pagará a la AAA todos los gastos documentales, administrativos y de arbitraje para cualquier arbitraje iniciado, de conformidad con las Normas de la AAA y esta disposición de arbitraje. Si usted prevalece en el arbitraje, LG cubrirá los honorarios y gastos de sus abogados, siempre y cuando sean razonables, de conformidad con ciertos factores que incluyen, entre otros, el monto de la compra y el monto del reclamo. No obstante lo indicado, si la ley aplicable permite una adjudicación de honorarios y gastos razonables de abogados, un árbitro puede otorgarlos en la misma medida que lo haría un tribunal. Si el árbitro considera que el fondo de su reclamo o la reparación solicitada en la demanda es frívola o se utiliza para un propósito inadecuado (calificado según las normas establecidas en la Norma Federal de Procedimiento Civil 11 (b)), el pago de todos los honorarios de arbitraje se regirá por las Normas de la AAA. En tal situación, usted se compromete a reembolsar a LG todos los fondos que haya erogado previamente, cuyo pago es, por otra parte, su obligación según las Normas de la AAA. Salvo disposición contraria, LG renuncia a cualquier derecho que pudiera tener para solicitarle los honorarios y gastos de sus abogados, si LG prevalece en el arbitraje.

**Audiencias y ubicación.** Si su reclamo es por \$25.000 o menos, puede optar por que el arbitraje sea realizado únicamente sobre la base de lo siguiente: (1) documentos presentados al árbitro; (2) a través de una audiencia telefónica; o (3) mediante una audiencia presencial, según lo establecido por las Normas de la AAA. Si su reclamo excede los \$25.000, el derecho a una audiencia estará determinado por las Normas de la AAA. Cualquier audiencia de arbitraje presencial se realizará en un lugar dentro del distrito judicial federal en el cual resida, a menos que ambas partes acuerden llevarla a cabo en otra ubicación o mediante un arbitraje telefónico.

**Exclusión.** Puede excluirse de este procedimiento de resolución del conflicto. Si se excluye, ni usted ni LG pueden solicitar al otro que participe en un procedimiento de arbitraje. Para excluirse, debe enviar una notificación a LG en un plazo de hasta 30 días continuos a partir de la fecha de la primera compra del consumidor del producto, por alguno de estos medios: (i) el envío de un correo electrónico a [optout@lge.com](mailto:optout@lge.com) con el siguiente Asunto: "Exclusión del arbitraje"; o (ii) por teléfono si llama al 1-800-980-2973. Debe incluir la siguiente información en el correo electrónico de exclusión o suministrarla por teléfono: (a) su nombre y dirección; (b) la fecha en la cual se compró el producto; (c) el nombre o el número del modelo del producto; y (d) el número de serie (puede encontrarse (i) en el producto o (ii) en el sitio <https://www.lg.com/us/support/repair-service/schedule-repair-continued> al hacer clic en "Find My Model & Serial Number" [Buscar mi modelo y número de serie]).

Solo puede excluirse del procedimiento de resolución de conflictos en la forma descrita anteriormente (es decir, por correo electrónico o por teléfono); ninguna otra forma de notificación será efectiva para hacerlo. Excluirse de este procedimiento de resolución de conflictos no afectará de ninguna manera la cobertura de la Garantía limitada, por lo que usted continuará disfrutando de todos sus beneficios. Si conserva este producto y no se excluye, acepta todos los términos y condiciones de la cláusula de arbitraje descrita anteriormente.





US	Please call the installing contractor of your product, as warranty service will be provided by them.
CANADA	Service call Number # : (888) LG Canada, (888) 542-2623 Numéro pour les appels de service : LG Canada, 1-888-542-2623