



CONFIDENTIAL

# Room Air Conditioner

## SVC MANUAL (Exploded View)

MODEL : K-SAE181A.AT3GEU1

### CAUTION

Before Servicing the unit, read the safety precautions in General SVC manual.  
Only for authorized service personnel.

Any reproduction, duplication, distribution (including by way of email, facsimile or other electronic means), publication, modification, copying or transmission of this Service Manual is STRICTLY PROHIBITED unless you have obtained the prior written consent of the LG Electronics entity from which you received this Service Manual. The material covered by this prohibition includes, without limitation, any text, graphics or logos in this Service Manual.

Copyright © 2024 LG Electronics Inc. All rights reserved. Only training and service purposes.

---

# IMPORTANT SAFETY INSTRUCTIONS

## READ ALL INSTRUCTIONS BEFORE USE

The following safety guidelines are intended to prevent unforeseen risks or damage from unsafe or incorrect operation of the appliance.

The guidelines are separated into 'WARNING' and 'CAUTION' as described below.

### Safety Messages

**Your safety and the safety of others are very important.**

We have provided many important safety messages in this manual and on your appliance. Always read and follow all safety messages.



This is the safety alert symbol.

This symbol alerts you to potential hazards that can kill or injure you and others. All safety messages will follow the safety alert symbol and either the word WARNING or CAUTION.

These words mean:



### WARNING

You may be killed or seriously injured if you do not follow instructions.



### CAUTION

You may be injured or cause damage to the product if you do not follow instructions.

All safety messages will tell you what the potential hazard is, tell you how to reduce the chance of injury, and tell you what may happen if the instructions are not followed.

### Notes for Flammable Refrigerant

The following symbols are displayed on units.



A2L



A2L

This symbol indicates that this appliance uses a flammable refrigerant. If the refrigerant is leaked and exposed to an external ignition source, there is a risk of fire.



This symbol indicates that the Owner's Manual should be read carefully.



This symbol indicates that service personnel should be handling this equipment with reference to the Installation Manual.



This symbol indicates that information is available in the Owner's Manual or Installation Manual.

### Notes for Safety Guide

- This appliance is not accessible to the general public.
- This appliance uses a flammable refrigerant. If the refrigerant is leaked and exposed to an external ignition source, there is a risk of fire.
- This appliance includes a ground connection that can be used for functional purposes only.
- Refer space of installation guide.
- Refer to refrigerant charge in the installation manual for additional refrigerant charge.

- 
- Outdoor unit can be installed and used outside.
  - Means for disconnection must be incorporated in the fixed wiring in accordance with the wiring rules.
  - If the supply cord is damaged, it must be replaced by the manufacturer, its service agent or similarly qualified persons in order to avoid a hazard.



## WARNING

- Do not use means to accelerate the defrosting process or to clean, other than those recommended by the manufacturer.
  - The appliance shall be stored in a room without continuously operating ignition sources (for example: open flames, an operating gas appliance or an operating electric heater.)
  - Do not pierce or burn.
  - Be aware that refrigerants may not contain an odour.
  - The manufacturer may provide other suitable examples or may provide additional information about the refrigerant odour.
- Pipe-work including piping material, pipe routing, and installation shall include protection from physical damage in operation and service, and be in compliance with national and local codes and standards, such as ASHRAE 15, ASHRAE 15.2, IAPMO Uniform Mechanical Code, ICC International Mechanical Code, or CSA B52. All field joints shall be accessible for inspection prior to being covered or enclosed.
  - To ensure no leaking, field-made refrigerant joints indoors shall be tightness tested. The test method shall have a sensitivity of 5 grams per year of refrigerant or better under a pressure of at least 0.25 times the maximum allowable pressure. No leak shall be detected.
  - **Technical Safety**
    - This appliance can be used by children aged from 8 years and above and persons with reduced physical, sensory or mental capabilities or lack of experience and knowledge if they have been given supervision or instruction concerning use of the appliance in a safe way and understand the hazards involved. Children shall not play with the appliance. Cleaning and user maintenance shall not be made by children without supervision.
  - **Installation**
    - Contact an authorized service center when installing or relocating the air conditioner.
    - Do not install the air conditioner on an unstable surface or in a place where there is danger of it falling.
  - **Operation**
    - Do not modify or extend the power cable. Scratches or peeling insulation on the power cables may result in fire or electric shock, and should be replaced.
    - Make sure that the power cable is neither dirty, loose, nor broken.
  - The refrigerant and insulation blowing gas used in the appliance require special disposal procedures.
  - Consult a service agent or a similarly qualified person before disposing of them.
  - This appliance is not intended for the purposes of cooling INFORMATION TECHNOLOGY EQUIPMENT.

---

- **Qualification of workers**

The manual shall contain specific information about the required qualification of the working personnel for maintenance, service and repair operations. Every working procedure that affects safety means shall only be carried out by qualified person by manufacturer. Examples of such work procedures are as follows:

- breaking into the refrigerating circuit;
- opening of sealed components;
- opening of ventilated enclosures.

- **Ventilated area**

Ensure that the area is open and adequately ventilated before accessing the system or performing high temperature work.

A certain level of ventilation must be maintained for the duration of the work.

Ventilation should be such that any refrigerant emitted is safely dispersed and preferably moistened into the outside atmosphere.

- **Cabling**

Check that the cable is not subject to wear, corrosion, excessive pressure, vibration, sharp edges, or other adverse environmental influences. When checking, you should also take into account the effects of aging or continuous vibration of ignition sources such as compressors or fans.

- **Detection of flammable refrigerants**

Under no circumstances should potential ignition sources be used to detect or detect refrigerant leaks. Do not use halide lamps (or other detectors that use fine salts).

- **Leak detection methods**

The following leak detection methods are deemed acceptable for all refrigerant systems.

Electronic leak detectors may be used to detect refrigerant leaks but, in the case of FLAMMABLE REFRIGERANTS, the sensitivity may not be adequate, or may need recalibration. (Detection equipment shall be calibrated in a refrigerant-free area.) Ensure that the detector is not a potential source of ignition and is suitable for the refrigerant used. Leak detection equipment shall be set at a percentage of the LFL of the refrigerant and shall be calibrated to the refrigerant employed, and the appropriate percentage of gas (25 % maximum) is confirmed. Leak detection fluids are also suitable for use with most refrigerants but the use of detergents containing chlorine shall be avoided as the chlorine may react with the refrigerant and corrode the copper pipe-work.

Examples of leak detection fluids are:

- bubble method
- fluorescent method agents

If a leak is suspected, all naked flames shall be removed/extinguished.

If a leakage of refrigerant is found which requires brazing, all of the refrigerant shall be recovered from the system, or isolated (by means of shutoff valves) in a part of the system remote from the leak. Removal of refrigerant shall be according to removal and evacuation procedure.

---

- **Removal and evacuation**

When breaking into the refrigerant circuit to make repairs – or for any other purpose – conventional procedures shall be used. However, for flammable refrigerants it is important that best practice be followed, since flammability is a consideration. The following procedure shall be adhered to:

- safely remove refrigerant following local and national regulations;
- evacuate;
- purge the circuit with inert gas (optional for A2L);
- evacuate (optional for A2L);
- continuously flush or purge with inert gas when using flame to open circuit; and
- open the circuit.

The refrigerant charge shall be recovered into the correct recovery cylinders if venting is not allowed by local and national codes. For appliances containing flammable refrigerants, the system shall be purged with oxygen-free nitrogen to render the appliance safe for flammable refrigerants. This process might need to be repeated several times. Compressed air or oxygen shall not be used for purging refrigerant systems.

For appliances containing flammable refrigerants, refrigerants purging shall be achieved by breaking the vacuum in the system with oxygen-free nitrogen and continuing to fill until the working pressure is achieved, then venting to atmosphere, and finally pulling down to a vacuum (optional for A2L). This process shall be repeated until no refrigerant is within the system (optional for A2L). When the final oxygen-free nitrogen charge is used, the system shall be vented down to atmospheric pressure to enable work to take place.

The outlet for the vacuum pump shall not be close to any potential ignition sources, and ventilation shall be available.

- **Charging procedures**

In addition to the existing filling procedure, the following requirements must be observed: When using the charging device, make sure that it is not contaminated with other refrigerants. The hose or pipe should be as short as possible to minimize the amount of refrigerant in it. The cylinder should be stored in the proper location according to the instructions. Make sure the refrigeration system is grounded before filling the system with refrigerant. When charging is complete, label the system (if it is not already there). Be careful not to overfill there frigerant. Before recharging the system, a pressure test should be performed with an appropriate purge gas. After charging is complete and before Dry Run, the system must be inspected for leaks. Follow-up should be carried out before waa leaving the site.

- **Recovery**

When removing refrigerant from a system, either for servicing or decommissioning, it is recommended good practice that all refrigerants are removed safely.

When transferring refrigerant into cylinders, ensure that only appropriate refrigerant recovery cylinders are employed. Ensure that the correct number of cylinders for holding the total system charge is available. All cylinders to be used are designated for there covered refrigerant and labelled for that refrigerant (i.e. special cylinders for the recovery of refrigerant). Cylinders shall be complete with pressure-relief valve and associated shut-off valves in good working order. Empty recovery cylinders are evacuated and, if possible, cooled before recovery occurs.

The recovery equipment shall be in good working order with a set of instructions concerning the equipment that is at hand and shall be suitable for the recovery of the flammable refrigerant. If in doubt, the manufacturer should be consulted. In addition, a set of calibrated weighing scales shall be available and in good working order. Hoses shall be complete with leak-free disconnect couplings and in good condition.

The recovered refrigerant shall be processed according to local legislation in the correct recovery cylinder, and the relevant waste transfer note arranged. Do not mix refrigerants in recovery units and especially not in cylinders.

If compressors or compressor oils are to be removed, ensure that they have been evacuated to an acceptable level to make certain that flammable refrigerant does not remain within the lubricant. The compressor body shall not be heated by an open flame or other ignition sources to accelerate this process. When oil is drained from a system, it shall be carried out safely.

---

- **Checks to the area**

Prior to beginning work on systems containing flammable refrigerants, safety checks are necessary to ensure that the risk of ignition is minimized. For repair to the refrigerating system, the following precautions shall be complied with prior to conducting work on the system.

- **Work procedure**

Work shall be undertaken under a controlled procedure so as to minimize the risk of a flammable gas or vapour being present while the work is being performed.

- **General work area**

All maintenance staff and others working in the local area shall be instructed on the nature of work being carried out. Work in confined spaces shall be avoided.

- **Checking for presence of refrigerant**

The area shall be checked with an appropriate refrigerant detector prior to and during work, to ensure the technician is aware of potentially flammable atmospheres. Ensure that the leak detection equipment being used is suitable for use with flammable refrigerants, i.e. non-sparking, adequately sealed or intrinsically safe.

- **Presence of fire extinguisher**

If any hot work is to be conducted on the refrigerating equipment or any associated parts, appropriate fire extinguishing equipment shall be available to hand. Have a dry powder or CO2 fire extinguisher adjacent to the charging area.

- **No ignition sources**

No person carrying out work in relation to a refrigerating system which involves exposing any pipe work shall use any sources of ignition in such a manner that it may lead to the risk of fire or explosion.

All possible ignition sources, including cigarette smoking, should be kept sufficiently far away from the site of installation, repairing, removing and disposal, during which refrigerant can possibly be released to the surrounding space.

Prior to work taking place, the area around the equipment is to be surveyed to make sure that there are no flammable hazards or ignition risks. "No Smoking" signs shall be displayed.

- **Checks to the refrigerating equipment**

Where electrical components are being changed, they shall be fit for the purpose and to the correct specification.

At all times the manufacturer's maintenance and service guidelines shall be followed. If in doubt consult the manufacturer's technical department for assistance.

The following checks shall be applied to installations using flammable refrigerants:

- The actual refrigerant charge is in accordance with the room size within which the refrigerant containing parts are installed.
- The ventilation machinery and outlets are operating adequately and are not obstructed.
- If an indirect refrigerating circuit is being used, the secondary circuit shall be checked for the presence of refrigerant.
- Marking to the equipment continues to be visible and legible. Markings and signs that are illegible shall be corrected.
- Refrigerating pipe or components are installed in a position where they are unlikely to be exposed to any substance which may corrode refrigerant containing components, unless the components are constructed of materials which are inherently resistant to being corroded or are suitably protected against being so corroded.

---

- **Checks to electrical devices**

Repair and maintenance to electrical components shall include initial safety checks and component inspection procedures. If a fault exists that could compromise safety, then no electrical supply shall be connected to the circuit until it is satisfactorily dealt with. If the fault cannot be corrected immediately but it is necessary to continue operation, an adequate temporary solution shall be used. This shall be reported to the owner of the equipment so all parties are advised.

Initial safety checks shall include:

- Capacitors are discharged: this shall be done in a safe manner to avoid possibility of sparking.
- No live electrical components and wiring are exposed while charging, recovering or purging the system.
- Continuity of earth bonding.

- **Repair to sealed components**

“Sealed electrical components shall be replaced.”

- **Repair to intrinsically safe components**

“Intrinsically safe components must be replaced.”

- **Decommissioning**

Before carrying out this procedure, it is essential that the technician is completely familiar with the equipment and all its detail.

It is recommended good practice that all refrigerants are recovered safely. Prior to the task being carried out, an oil and refrigerant sample shall be taken in case analysis is required prior to re-use of recovered refrigerant. It is essential that electrical power is available before the task is commenced.

- a) Become familiar with the equipment and its operation.
- b) Isolate system electrically.
- c) Before attempting the procedure ensure that:
  - mechanical handling equipment is available, if required, for handling refrigerant cylinders
  - all personal protective equipment is available and being used correctly
  - the recovery process is supervised at all times by a competent person
  - recovery equipment and cylinders conform to the appropriate standards.
- d) Pump down refrigerant system, if possible.
- e) If a vacuum is not possible, make a manifold so that refrigerant can be removed from various parts of the system.
- f) Make sure that cylinder is situated on the scales before recovery takes place.
- g) Start the recovery machine and operate in accordance with instructions.
- h) Do not overfill cylinders. (No more than 80 % volume liquid charge).
- i) Do not exceed the maximum working pressure of the cylinder, even temporarily.
- j) When the cylinders have been filled correctly and the process completed, make sure that the cylinders and the equipment are removed from site promptly and all isolation valves on the equipment are closed off.
- k) Recovered refrigerant shall not be charged into another refrigerating system unless it has been cleaned and checked.

---

- **Labelling**

Equipment shall be labelled stating that it has been de-commissioned and emptied of refrigerant.

The label shall be dated and signed.

Ensure that there are labels on the equipment stating the equipment contains flammable refrigerant.

- Mechanical connections (mechanical connectors or flared joints) shall be accessible for maintenance purposes.
- When mechanical connectors are reused indoors, sealing parts shall be renewed.
- When flared joints are reused indoors, the flare part shall be re-fabricated.
- This appliance incorporates an earth connection for functional purposes only.
- Flexible pipe elements shall be protected against mechanical damage, excessive stress by torsion, or other forces. They should be checked for mechanical damage annually.
- Protection devices, piping and fittings shall be protected as far as possible against adverse environmental effects, for example, the danger of water collecting and freezing in relief pipes or the accumulation of dirt and debris.
- Precautions shall be taken to avoid excessive vibration or pulsation to refrigerating piping.
- Piping in refrigerating systems shall be so designed and installed to minimize the likelihood hydraulic shock damaging the system.
- Provision shall be made for expansion and contraction of long runs of piping.
- Use a supply cord shall be between 1.5~3 m(4.9~9.8 ft) long and shall be either an extra hard usage or a hard usage cord.
- Capacities of supply cords and attachment plugs shall not be less than the current rating of the appliance and shall be suitable for the application in accordance with national electrical installation requirements.
- An unventilated area where the appliance using flammable refrigerants is installed shall be so constructed that should any refrigerant leak, it will not stagnate so as to create a fire or explosion hazard.
- non-duct connected appliances containing A2L refrigerants with the supply and return air openings in the conditioned space may have the body of the appliance may be installed in open areas such as false ceilings not being used as return air plenums, as long as the conditioned air does not directly communicate with the air of the false ceiling.
- **For appliances with REFRIGERANT DETECTION SYSTEMS, the instructions shall include the following (LEAK DETECTION SYSTEM can be installed optionally for the safety purpose) :**

For REFRIGERANT DETECTION SYSTEMS, the function and operation and required servicing measures.

For LIMITED LIFE REFRIGERANT SENSORS used in REFRIGERANT DETECTION SYSTEMS, the specified end of life and instructions for replacement.

REFRIGERANT SENSORS for REFRIGERANT DETECTION SYSTEMS shall only be replaced with sensors specified by the appliance manufacture.

LEAK DETECTION SYSTEM installed. Unit must be powered except for service.

This unit is equipped with a refrigerant leak detector for safety. To be effective, the unit must be electrically powered at all times after installation, other than when servicing.

---

## WARNING INSTRUCTIONS



### WARNING

- To reduce the risk of explosion, fire, death, electric shock, injury or scalding to persons when using this product, follow basic precautions, including the following:

### Technical Safety

- This appliance is not intended for use by persons (including children) with reduced physical, sensory or mental capabilities, or lack of experience and knowledge, unless they have been given supervision or instruction concerning use of the appliance by a person responsible for their safety. Children should be supervised to ensure that they do not play with the appliance.
- Installation or repairs made by unauthorized persons can pose hazards to you and others.
- The information contained in the manual is intended for use by a qualified service technician who is familiar with the safety procedures and equipped with the proper tools and test instruments.
- Failure to read and follow all instructions in this manual can result in equipment malfunction, property damage, personal injury and/or death.
- When the power cord is to be replaced, the replacement work shall be performed by authorized personnel using only genuine replacement parts.
- If the supply cord is damaged, it must be replaced by the manufacturer, its service agent or similarly qualified person in order to avoid a hazard.
- Installation MUST conform to the local building codes or, in the absence of local codes, the National Electrical Code NFPA 70/ANSI C1-1003 or current edition and Canadian Electrical Code Part 1 CSA C.22. 1.
- After completion of field piping for split systems, the field pipework shall be pressure tested with an inert gas and then vacuum tested prior to refrigerant charging, according to the following requirements:
  - The minimum test pressure for the low side of the system shall be the low side design pressure and the minimum test pressure for the high side of the system shall be the high side design pressure, unless the high side of the system, cannot be isolated from the low side of the system in which case the entire system shall be pressure tested to the low side design pressure.
  - The test pressure after removal of pressure source shall be maintained for at least 1 h with no decrease of pressure indicated by the test gauge, with test gauge resolution not exceeding 5% of the test pressure.
  - During the evacuation test, after achieving a vacuum level specified in the manual or less, the refrigeration system shall be isolated from the vacuum pump and the pressure shall not rise above 1500 microns within 10 min. The vacuum pressure level shall be specified in the manual, and shall be the lessor of 500 microns or the value required for compliance with national and local codes and standards, which may vary between residential, commercial, and industrial buildings.
- Steel pipes and components shall be protected against corrosion with a rustproof coating before applying any insulation.
- If appliances with A2L refrigerants connected via an air duct system to one or more rooms are installed in a room with an area less than A min as determined in Clause GG.2, that room shall be without continuously operating open flames (for example an operating gas appliance) or other potential ignition sources (for example an operating electric heater, hot surfaces). A flame-producing device may be installed in the same space if the device is provided with an effective flame arrest;
- Auxiliary devices which can be potential ignition source shall not be installed in connecting ductwork. Examples of potential ignition sources are UV lights, electric heaters with a temperature exceeding 700 °C, pilot flames, brushed motors and similar devices.
- Servicing shall be performed only as recommended by the manufacturer.

---

## Installation

- Contact an authorized service center when installing or relocating the air conditioner.
- Do not install the air conditioner on an unstable surface or in a place where there is danger of it falling.
- Do not install the unit in potentially explosive atmospheres.
- Do not install the air conditioner in a place where flammable liquids or gases such as gasoline, propane, paint thinner, etc., are stored.
- Install the panel and the cover of the control box safely.
- Install a dedicated electric outlet and circuit breaker before using the air conditioner.
- Use standard circuit breaker and fuse that conform to the rating of the air conditioner.
- Make sure that the pipe and the power cable connecting the indoor and outdoor units are not pulled too tight when installing the air conditioner.
- The indoor/outdoor wiring connections must be secured tightly, and the cable should be routed properly so that there is no force pulling the cable from the connection terminals. Improper or loose connections can generate heat or cause a fire.
- Do not connect the ground wire to a gas pipe, a lightning rod, or a telephone ground wire.
- Use non-flammable gas (nitrogen) to check for leaks and to purge air; using compressed air or flammable gas may cause fire or explosion.
- The indoor unit got power from outdoor unit. Details of fuses or circuit breakers are indicated in installation manual of outdoor unit.

## Operation

- Do not modify or extend the power cable. Scratches or peeling insulation on the power cables may result in fire or electric shock, and should be replaced.
- Make sure that the power cable is neither dirty, loose, nor broken.
- Do not place any objects on the power cable.
- Do not place a heater or other heating appliances near the power cable.
- Take care to ensure that the power cable could not be pulled out or damaged during operation.
- Never touch, operate, or repair the air conditioner with wet hands.
- Do not insert hands or other objects through the air inlet or outlet while the air conditioner is operating.
- Make sure that children do not climb on or hit the outdoor unit.
- Be sure to use only those parts listed in the service parts list. Never attempt to modify the equipment.
- Do not touch the refrigerant pipe, water pipe or any internal parts while the unit is operating or immediately after operation.
- Do not leave flammable substances such as gasoline, benzene, or thinner near the air conditioner.
- Do not use the air conditioner for an extended period of time in a small place without proper ventilation.
- Be sure to ventilate sufficiently when the air conditioner and a heating appliance such as a heater are used simultaneously.

- 
- Do not block the inlet or outlet of airflow.
  - Cut off the power supply if there is any noise, smell, or smoke coming from the air conditioner.
  - Contact an authorized service center when the air conditioner is submerged by flood waters.
  - In the event of a gas leak (such as Freon, propane gas, LP gas, etc.) ventilate sufficiently before using the air conditioner again.
  - Cut off the power supply immediately in the event of a blackout or a thunderstorm.

## **Remote Control**

- Remove the batteries if the remote control is not to be used for an extended period of time.
- Never mix different types of batteries, or old and new batteries for the remote control.
- Do not recharge or disassemble the batteries.
- Stop using the remote control if there is a fluid leak in the battery. If your clothes or skin is exposed to the leaking battery fluid, wash off with clean water.
- If the leaking battery fluid has been swallowed, rinse the inside of the mouth thoroughly and consult a doctor.
- Dispose of the batteries in a place where there is no danger of fire.

## **Maintenance**

- Before cleaning or performing maintenance, disconnect the power supply and wait until the fan stops.
- Do not clean the appliance by spraying water directly onto the product.

---

## Refrigerant

### General

- Follow the standards of the corresponding region or country for handling the refrigerant and the air conditioner and for disassembling the air conditioner.
- Use only the refrigerant specified on the air conditioner label.
- Do not input air or gas into the system except the specified refrigerant.
- Do not touch the leaking refrigerant during installation or repair.
- Be sure to check for refrigerant leaks after installing or repairing the air conditioner.
- The appliance shall be stored so as to prevent mechanical damage from occurring.

### R32 Only



- Any person who is involved with working on or breaking into a refrigerant circuit should hold a current valid certificate from an industry-accredited assessment authority, which authorizes their competence to handle refrigerants safely in accordance with an industry recognized assessment specification.
- Servicing shall only be performed as recommended by the equipment manufacturer. Maintenance and repair requiring the assistance of other skilled personnel shall be carried out under the supervision of the person competent in the use of flammable refrigerants.
- The appliance shall be stored in a well-ventilated area where the room size corresponds to the room area as specified for operation.
- Keep any required ventilation openings clear of obstruction.
- The appliance shall be stored in a room without continuously operating open flames (for example an operating gas appliance) and ignition sources (for example an operating electric heater).

## CAUTION INSTRUCTIONS

### CAUTION

- To reduce the risk of minor injury to persons, malfunction, or damage to the product or property when using this product, follow basic precautions, including the following:

## Installation

- Transport the air conditioner with two or more people or use a forklift.
- Install the outdoor unit such that it is protected from direct sunlight. Do not place the indoor unit in a place where it is directly exposed to sunlight via the windows.
- Do not install the air conditioner in an area where it is directly exposed to sea wind (salt spray).
- Install the drain hose properly for the smooth drainage of water condensation.
- Install the air conditioner in a place where the noise from the outdoor unit or the exhaust fumes will not inconvenience the neighbors. Failure to do so may result in conflict with the neighbors.
- Safely dispose of packing materials such as screws, nails, plastic bags or batteries using proper packaging after installation or repair.
- Exercise caution when unpacking or installing the air conditioner.

---

## Operation

- Make sure that the filter is installed before operating the air conditioner.
- Do not drink the water drained from the air conditioner.
- Do not place any object on the air conditioner.
- Do not let the air conditioner run for a long time when humidity is very high or when a door or a window has been left open.
- Do not expose people, animals, or plants to the cold or hot wind from the air conditioner for extended periods of time.
- Do not use the product for special purposes, such as preserving foods, works of art, etc. the air conditioner is designed for consumer purposes, and is not a precision refrigeration system. There is risk of damage or loss of property.

## Maintenance

- Use a sturdy stool or ladder when cleaning, maintaining, or repairing the air conditioner at a height.
- Never use strong cleaning agents or solvents or spray water when cleaning the air conditioner. Use a soft cloth.
- Never touch the metal parts of the air conditioner when removing the air filter.
- To clean the interior, contact an authorized service center or dealer. Using harsh detergents may cause corrosion or damage to the unit.

## Installation Guide

- The appliance shall be installed in accordance with national wiring regulations.
- Compliance with national gas regulations shall be observed.
- Appliance shall be disconnected from its power source during service and when replacing parts.
- Check that appliance's voltage level is 90 % ~ 110 % of the rated voltage. (To check it, refer to the label attached to the side of the appliance.)
- Do not install the appliance on an unstable surface or in a place where there is danger of it falling.
- This appliance must be grounded. In the event of malfunction or breakdown, grounding will reduce the risk of electric shock by providing a path of least resistance for electric current.
- Improper connection of the equipment-grounding conductor can result in risk of electric shock. Check with a qualified electrician or service personnel if you are in doubt as to whether the appliance is properly grounded.
- If the power supply cable is damaged or the cable connection is loose, do not use the power supply cable and contact an authorized service center.
- Do not share the power supply for this unit with other appliances or devices, it must be a dedicated power source for this appliance.
- Ensure the power cable is secure so that it does not come out while the appliance is operating.
- Do not touch the power plug or the appliance controls with wet hands.
- Cut the power during a severe thunderstorm or lightening or when not in use for a long period of time.
- Do not grab the power cable when removing the plug, but rather hold the power plug tightly.
- Do not bend the power cable excessively or place a heavy object on it.
- Do not turn on the circuit breaker or power when covers are removed or opened.
- Make sure that the pipe and the power cable connecting the indoor and outdoor units are not pulled too tight when installing the appliance.
- Install dedicated electric outlet and circuit breaker for the appliance.
- Make sure to close the cover of the control box after connecting the wiring to the appliance.
- Loose connections may cause electrical sparks, injury, and death.

- 
- Do not install the appliance in a place where flammable liquids or gases such as gasoline, propane, paint thinner, etc., are stored.
  - Only use the refrigerant designated on the label, do not put any foreign substances into the appliance.
  - Inert gas (oxygen free nitrogen) should be used when you checking for leaks, cleaning or repairs of pipes etc. If you are using combustible gases including oxygen, appliance may have the risk of fires and explosions.
  - If the air conditioner is installed in a small room, measures must be taken to prevent the refrigerant concentration from exceeding the safety limit when the refrigerant leaks.
    - Consult the dealer regarding the appropriate measures to prevent the safety limit from being exceeded. Should the refrigerant leak and cause the safety limit to be exceeded, hazards due to lack of oxygen in the room could result.
  - Do not use copper pipes which are deformed. Otherwise, the expansion valve or capillary tube may become blocked with contaminants.
  - Ducts connected to an appliance shall not contain an ignition source.
  - When installing or relocating the appliance, consult with a qualified technician to set up the appliance. The appliance should not be installed by someone without proper qualifications.
  - After pump down, power must be turned off before removing the pipe. It may cause explosion or injury.
  - Operating the appliance while it is disconnected to the pipe could result in explosion and damage. Use the appliance after connecting it to the pipe once the appliance has been relocated and the refrigerant circuit repaired.
  - Do not step on and climb on the outdoor unit. It may cause electric shock, fire or damage to the unit.
  - Close the extra installation hole.
  - Install at places where it can endure the weight and vibration/noise of the outdoor unit.
  - Install the appliance in a place where the noise from the outdoor unit or the exhaust air will not inconvenience the neighbors. Failure to do so may result in conflict with the neighbors.
  - Do not install the outdoor unit near the septic tank, drain or toilet exhaust duct. It results in a corrosion of a heat exchanger or pipe.
  - Ensure the appliance is installed level. Otherwise, it may cause vibration or water leakage.
  - Do not insert a drain hose in drain or soil pipe. Bad smells can occur and it results in a corrosion of a heat exchanger or pipe.
  - Do not discharge the refrigerant into the atmosphere.
  - If refrigerant leaks, ventilate the room.
  - Always check for gas (refrigerant) leakage after installation or repair of appliance.
  - Be cautious not to get injured by the sharp edges while installing the appliance or taking it out of its packaging.
  - Ensure that you carry by the chassis when you lift the unit.
  - This appliance should only be transported by two or more people holding the appliance securely.
  - During working on heights fasten safety belt to put for personal safety.
  - To avoid nitrogen entering the refrigerant system in a liquid state, the top of the cylinder must be higher than its bottom when you pressurize the system.
  - The tubing shall be protected to the extent that it will not be handled or used for carrying during moving of the appliance.
  - Ventilation system have to be installed in the space when appliance with R32 is using for cooling of electric equipment.

- 
- Do not use the appliance for special purposes, such as preserving foods, works of art, and etc. It is an appliance for consumer purposes, not a precision refrigerant system. There is risk of damage or loss of property.
  - This product has been designed and manufactured to meet ENERGY STAR criteria for energy efficiency when matched with appropriate coil components. However, proper refrigerant charge and proper air flow are critical to achieve rated capacity and efficiency. Installation of this product should follow the manufacturer's refrigerant charging and air flow instructions. Failure to confirm proper charge and airflow may reduce energy efficiency and shorten equipment life.
  - Refrigerant tubing shall be protected or enclosed to avoid damage.
  - Flexible refrigerant connectors (such as connecting lines between the indoor and outdoor unit) that may be displaced during normal operations shall be protected against mechanical damage.
  - The installation of pipe-work shall be kept to a minimum.
  - A brazed, welded, or mechanical connection shall be made before opening the valves to permit refrigerant to flow between the refrigerating system parts.

# 1. Product Specifications

Buyer Model	Set (Indoor / Outdoor)		Unit	K-SAE181A	KNSAE181A	KUSAE181A
Factory Model				S3-W18K233B	S3NW18K233B	S3UW18K233B
Capacity	Cooling	Min ~ Rated ~ Max	kW	1.08	5.28	5.74
			Btu/h	3,685	18,000	19,600
			kJ/h	-	-	-
			kcal/h	-	-	-
	Cooling (T3)	Min ~ Rated ~ Max	kW	-	-	-
			Btu/h	-	-	-
	Heating	Min ~ Rated ~ Max	kW	1.08	5.57	6.74
			Btu/h	3,685	19,000	23,000
			kJ/h	-	-	-
			kcal/h	-	-	-
	Heating -7 °C	Max	kW	-	-	-
	Cooling / Heating	Rated, Cooling(50%) - Heating(50%) - Heating(Low Temp.)	kW	-	-	-
			Btu/h	-	-	-
	Maximum Heating (@ ID 70 °F DB)	OD 19 / 17 °F DB / WB	Btu/h	15,800 (83%)		
OD 6 / 5 °F DB / WB		Btu/h	13,300 (70%)			
OD 1 / 0 °F DB / WB		Btu/h	-			
OD -3 / -4 °F DB / WB		Btu/h	-			
OD -12 / -13 °F DB / WB		Btu/h	-			
Cooling (@ ID 27 °C DB)	OD 43 / 29 °C DB	kW	-	-	-	
Power Input	Cooling	Min ~ Rated ~ Max	W	238	1,500	2,180
	Cooling (T3)	Min ~ Rated ~ Max	W	-	-	-
	Heating	Min ~ Rated ~ Max	W	238	1,600	2,450
	Cooling / Heating	Rated, Cooling(50%) - Heating(50%) - Heating(Low Temp.)	W	-	-	-
			OD 19 / 17 °F DB / WB	W	2,350	
	Maximum Heating (@ ID 70 °F DB)	OD 6 / 5 °F DB / WB	W	2,290		
		OD 1 / 0 °F DB / WB	W	-		
		OD -3 / -4 °F DB / WB	W	-		
OD -12 / -13 °F DB / WB		W	-			
Cooling (@ ID 27 °C DB)	OD 43 / 29 °C DB	W	-	-	-	
Running Current	Cooling	Min ~ Rated ~ Max	A	1.20	7.00	10.20
	Cooling (T3)	Min ~ Rated ~ Max	A	-	-	-
	Heating	Min ~ Rated ~ Max	A	1.20	7.50	11.60
	Cooling / Heating	Rated, Cooling(50%) - Heating(50%) - Heating(Low Temp.)	A	-	-	-
	Cooling (@ ID 27 °C DB)	OD 43 / 29 °C DB	A	-	-	-
EER2			W/W	3.52		
			(Btu/h)/W	12.00		
			(kJ/h)/W	-		
EER2 (T3)			W/W	-		
			(Btu/h)/W	-		
EER2_Input manually			W/W	-		
			(Btu/h)/W	-		
EER2 (T3)_Input manually			W/W	-		
			(Btu/h)/W	-		
EER2_Test			(Btu/h)/W	-		
SEER2			-	18.0		
P design C			kW	-		
COP			W/W	3.48		
			(Btu/h)/W	11.88		
			(kJ/h)/W	-		
COP_Input manually			W/W	-		
			(Btu/h)/W	-		
SCOP			-	-		
HSPF2	$\frac{W}{V}$		-	8.9	7.1	
P design H			kW	-		
APF			-	-		
Energy Label Grade	Cooling		-	-		
	Heating		-	-		
Energy Star			-	Yes		

Buyer Model	Set (Indoor / Outdoor)		Unit	K-SAE181A	KNSAE181A	KUSAE181A	
Factory Model				S3-W18K233B	S3NW18K233B	S3UW18K233B	
Tax Credit			-	No			
Most Efficient			-	No			
Annual Energy Consumption	Cooling		kWh/year	-			
	Heating		kWh/year	-			
Operating Wattage			kWh	-			
Standby Wattage			Wh	-			
Annual Energy Cost			\$	-			
Annual Power Fee			THB	-			
Weighted Input Power			W	-			
Weighted EER			(Btu/h)/W	-			
			W/W	-			
Power Supply			Ø, V, Hz	1	208/230	60	
Available Voltage Range			V	187 ~ 253			
Power Factor	Cooling		%	96.0			
	Heating		%	96.0			
Moisture Removal			l/h	1.60			
			pts/h	3.38			
Indoor	Air Flow Rate	Cooling, Max / H / M / L	m <sup>3</sup> /min	19.5 / 14.5 / 13.0 / 10.5			
			CFM	689 / 512 / 459 / 371			
		Heating, Max / H / M / L	m <sup>3</sup> /min	18.5 / 16.0 / 13.5 / 11.0			
			CFM	653 / 565 / 477 / 388			
	Fan Motor Speed	Cooling, Max/H/HMM/ML/L/SL	rpm	1600/1200/1100/1000/920/850/700			
		Heating, Max/H/HMM/ML/L/SL	rpm	1600/1200/1100/1000/920/850/700			
	Sound Pressure Level	Cooling, Max / H / M / L / SL	dB(A)	- / 48 / 43 / 38 / 32			
		Heating, Max / H / M / L	dB(A)	- / 48 / 43 / 38			
	Sound Power Level			dB(A)	-		
	Dimensions (W × H × D)	Net		mm	998	345	210
				in.	39-9/32	13-19/32	8-9/32
		Shipping		mm	1068	425	279
				in.	42-1/16	16-23/32	10-31/32
	Weight	Net		kg	11.8		
				lb.	26.0		
		Shipping		kg	13.6		
				lb.	30.0		
	Disconnect Switch			A	20		
	Exterior Color Code			-	Munsell 7.5BG 10/2		
				-	RAL 9016		
Operation Range	Cooling		°C DB	18 ~ 32			
			°F DB	64.4 ~ 89.6			
	Cooling		°C WB	12 ~ 23.9			
			°F WB	53 ~ 75			
	Maximum Relative Humidity		%	78			
	Heating		°C DB	16 ~ 30			
		°F DB	60.8 ~ 86				
Air Flow Rate	Max		m <sup>3</sup> /min	49.0			
			CFM	1730			
Fan Motor Speed	Cooling, Min ~ Max	rpm	190	-	850		
	Heating, Min ~ Max	rpm	190	-	850		
Sound Pressure Level	Cooling, Rated	dB(A)	55				
	Heating, Rated	dB(A)	55				
Sound Power Level			dB(A)	-			
Dimensions (W × H × D)	Net		mm	870	650	330	
			in.	34-1/4	25-19/32	13	
	Shipping		mm	1040	710	455	
			in.	40-15/16	27-15/16	17-29/32	
Weight	Net		kg	42.0			
			lb.	92.6			
	Shipping		kg	46.5			
			lb.	102.5			
Max. Fuse Size			A	20			
Exterior Color Code			-	Munsell 9.54Y 8.34/1.31			
			-	RAL 9001			
Operation Range	Cooling		°C DB	-10 ~ 48			
			°F DB	14 ~ 118			
	Heating		°C DB	-			
			°F DB	-			
	Heating		°C WB	-15 ~ 18.3			
			°F WB	5 ~ 65			

Buyer Model		Set (Indoor / Outdoor)	Unit	K-SAE181A	KNSAE181A	KUSAE181A
Factory Model				S3-W18K233B	S3NW18K233B	S3UW18K233B
Minimum Circuit Ampacity			A	15.0		
Circuit Breaker			A	20		
Power Supply Cable			No.	3		
			mm <sup>2</sup>	2.5		
Power Supply to Unit			AWG	12		
			-	Outdoor		
Power and Communication Cable			No.	4		
			mm <sup>2</sup>	1		
			AWG	18		
Piping	Size	Liquid	mm	ø 6.35		
			in.	ø 1/4		
	Gas	mm	ø 12.7			
		in.	ø 1/2			
Connections Method		Indoor / Outdoor	-	Flared / Flared		
Drain Hose Size		O.D. I.D	mm	21.5, 16.0		
			in.	27/32, 5/8		
Between Indoor & Outdoor	Piping Length	Min / Standard / Max	m	3	7.5	20
			ft.	9.8	24.6	65.6
		No Charge	m	7.5		
	Max. Elevation Difference	m	10			
		ft.	32.8			
	Piping Connection Heat Insulation		-	Both liquid and gas pipes		
Refrigerant	Type	-	R32			
		Pre Charge	g	1100		
	Additional Charge	oz	38.8			
		g/m	20			
	Control	-	Electronic Expansion Valve			
	Global Warning Potential	-	675			
t-CO <sup>2</sup> eq	-	0.743				
Defrost Method		-	Reverse Cycle			
Tool Code (Chassis)		Indoor / Outdoor	-	SK / U24A		
Compressor	Type	-	Twin Rotary			
	Model	-	KTN150D53UFT3			
	Motor Type	-	BLDC			
	Oil Type / Maker	-	Ester VG74 / -			
	Oil Charge	cc	420			
	O.L.P. Name	-	-			
	Manufacturer / Country of Origin	-	GMCC / China			
Fan(Indoor)	Type	-	Cross Flow Fan			
	Motor Output	W	58			
Fan(Outdoor)	Type	-	Propeller Fan			
	Motor Type	-	BLDC			
	Motor Output	W	85			
	Motor Insulation	-	Class E			
	Motor Enclosure / Ingress Protection	-	TEAO	IPX4		
Heat Exchanger	Evaporator	Material, Tube / Fin	-	Cu / Al		
		(ø x Row x Column x FPI x L) x Qty.	#1	(ø7 x 2 x 16 x 20 x 744) x 1		
		(ø x Row x Column x FPI x L) x Qty.	#2	-		
		(ø x Row x Column x FPI x L) x Qty.	#3	-		
		(ø x Row x Column x FPI x L) x Qty.	#4	-		
	Corrosion Protection	-	PCM			
	Fin Type	-	Slit			
	Condenser	Material, Tube / Fin	-	Cu / Al		
		(ø x Row x Column x FPI x L) x Qty.	#1	(ø7 x 2 x 28 x 18 x 938) x 1		
		(ø x Row x Column x FPI x L) x Qty.	#2	-		
Corrosion Protection		-	Gold			
Fin Type		-	Corrugate			
Max Piping Length Capacity	Cooling	%	95.0			
	Heating	%	96.0			

**Note**

- : No Relation
- All power supply and communication cables and circuit breaker must comply with applicable local and national codes.
- Exterior color code is approximate value.
- It is difficult to measure air flow rate of sleep because of small calue.
- Maximum heating capacity is for heating operation without any frost.
- Fan motor speed could vary ±20 rpm according to the operating conditions.
- It may cause reliability, performance, noise, and vibration problem, unless meeting the range of connecting pipe length.  
Keep the minimum piping length by making loops, although indoor unit and outdoor unit are close.
- This product contains fluorinated greenhouse gases.
- Some spacifications may be changed without notifications due to our policy of innovation.
- Test conditions are based on AHRI 210/240.
- \*: HSPF Region V = HSPF Region IV / 1.15
  - HSPF IV valies comply with US standard
  - HSPF V valies comply with Canada standard
- \*2: With wind baffle installed, the minimum temperature be 0 F° (-18°C) D.B. in cooling

kW = Btu/h x 0.29308
CFM = CMM x 35.3

## 2. Function

Category	Function	K-5AE181A	
		S3-W18K233B	
Air Flow	Air Supply Outlet	1	
	Airflow Direction Control (Left & Right)	Manual	
	Airflow Direction Control (Up & Down)	6 Steps	
	Auto Swing (Left & Right)	X	
	Auto Swing (Up & Down)	o	
	Fan Speed Steps (Fan / Cool / Heat)	6 / 6 / 6	
	Natural Wind (Auto Wind)	o	
	Jet Cool / Jet Heat (Power Wind)	o / o	
	Auto Fan (Fan Speed Auto)	o / o	
	Comfort Air	o	
Air Purifying	Prefilter (Washable / Anti-Bacteria)	o	
	Deodorizing Filter	X	
	Micro Dust Filter	X	
	Allergy Filter	X	
	Plasma Air Purifier (Ionizer)	X	
Installation	UV Nano	X	
	Drain Pump	X	
Reliability	Hot Start	o	
	Self Diagnosis	o	
	De-ice Control (Defrost)	o	
	Dry (Dehumidification) Operation	o	
Convenience	Auto Changeover	o	
	Auto Operation (Artificial Intelligence)	X	
	Auto Cleaning (Coil Dry)	o	
	Auto Restart Operation	o	
	Child Lock <sup>1</sup>	X	
	Forced Operation	o	
	Group Control <sup>1</sup>	X	
	Sleep Mode	12hr	
	Timer 24hr (On/Off) / 7hr (Off)	o / X	
	Timer (Weekly) <sup>1</sup>	o	
	Two Thermistor Control <sup>1</sup>	o	
	Low Ambient Operation	o	
	Overheating Protection	o	
	Low Heating	o	
	Voice Control	X	
	Smart Scan (PIR)	X	
	LG AC Tag On (NFC)	X	
	Outdoor Silent Mode	X	
	Mosquito Away	X	
	Smart Diagnosis	o	
	Smart Care	o	
	Night Mode	o	
	Indoor Unit Display Type	Number Display	
Indoor Unit Display Light	On/Off		
Energy Display	X		
Energy Saving	Energy Saving	X	
	Energy Control	Active Energy Control	
	Gen Mode	X	
Individual Control	Wired Remote Controller (Premium) <sup>2</sup>	PREMTA000(A/B)	
	Wired Remote Controller (Standard) <sup>2</sup>	PREMTB10U	
	Wired Remote Controller (Simple with Mode Selection) <sup>2</sup>	PQRCVCL0Q(W)	
	Wired Remote Controller (Simple without Mode Selection) <sup>2</sup>	PQRCHA0Q(W)	
	Handheld Wireless Controller	(See Remote Controller Section)	AKB76044207
		Setting Temperature Range (Cooling)	18~30 °C (64~86 °F)
Setting Temperature Range (Heating)		16~30 °C (60~86 °F)	
CAC Network Function	General Central Controller (Non LGAP)	X	
	Network Solution (LGAP)	o	
	Dry Contact <sup>2</sup>	PDRYCB100, PDRYCB300, PDRYCB320, PDRYCB400	
	PDI (Power Distribution Indicator) <sup>2</sup>	X	
Special Function Kit	Outdoor Unit PI 485 <sup>2</sup>	X	
	Wi-Fi <sup>2</sup>	Embedded	
	Water Level Sensor Connection <sup>2</sup>	o	
	Wind Baffle Kit <sup>2</sup>	X	
	Sump Heater	X	
	Sheath Heater <sup>2</sup>	X	
	Crank Case Heater	X	
Smart Inverter Monitoring System (SIMs) <sup>2</sup>	PSWMOZ3		
Others	Mode Lock	Cooling Only or Heating Only	
	Temperature Control	Thermistor	
	DRED (Demand Response Enabling Device)	X	

O : Applied, X : Not Applied

<sup>•</sup> Filters are optional in some specific areas.

<sup>•1</sup> : This function can be operated only when the wired remote controller is connected. The applicability of each function depends on the above table.

<sup>•2</sup> : Optional accessories must be purchased separately. If shown as "Embedded", this function is included in product.

<sup>•</sup> The function Wi-Fi is only compatible with 2.4 GHz band. (802.11 b/g/n)

<sup>•</sup> Some specifications may be changed without notifications due to our policy innovation.

<sup>•</sup> The air conditioner which DRED is available is capable of DRM1, DRM2 and DRM3 and complies with standard AS/NZS 4755.3.1.

# 3. Refrigerant Cycle Diagram

Model : S3-W18K233B.AT3GEU1 (K-SAE181A)

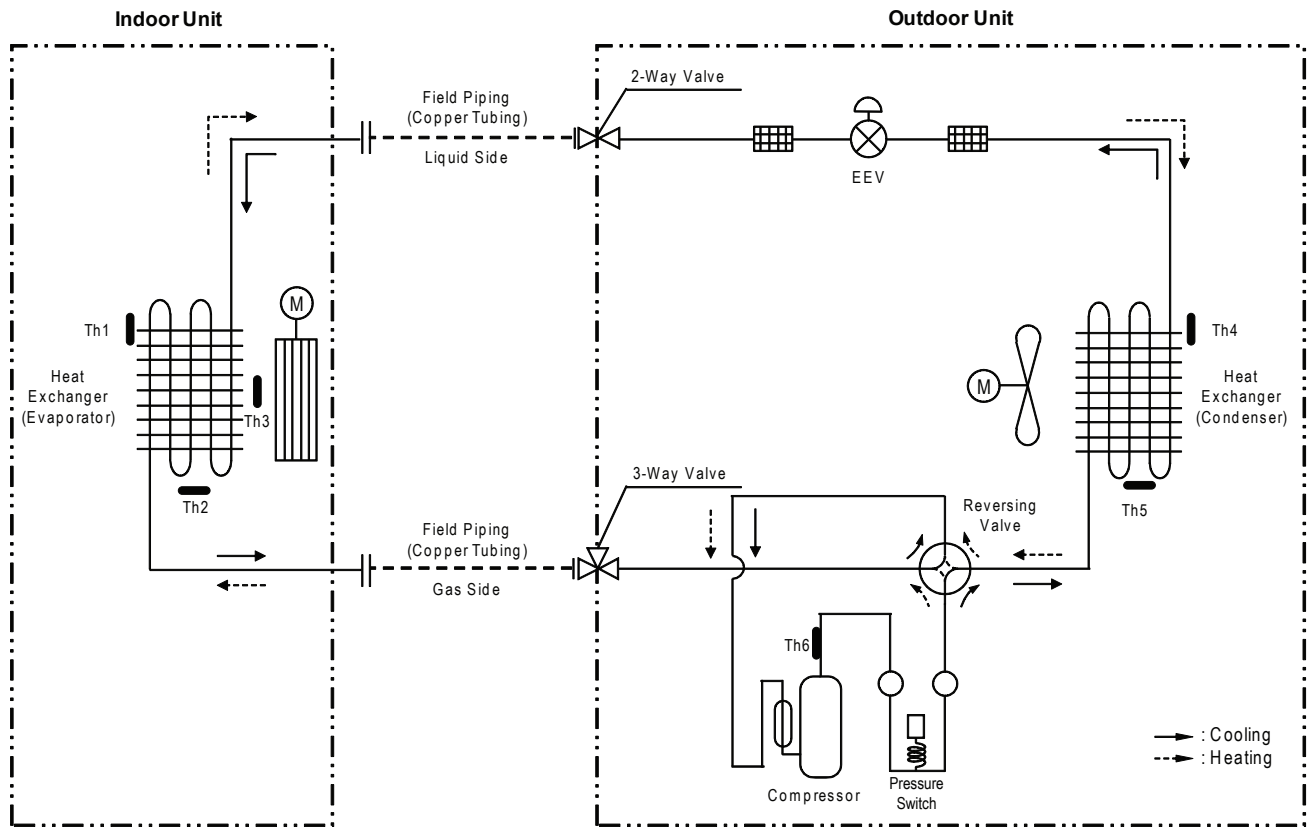

Loc.	Description	PCB Connector
Th1	Thermistor for indoor air temperature	CN_TH1 (Indoor)
Th2	Water Level Sensor (Option)	CN_TH2 (Indoor)
Th3	Thermistor for evaporator temperature	CN_TH3 (Indoor)
Th4	Thermistor for outdoor air temperature	CN_TH1 (Outdoor)
Th5	Thermistor for condensing temperature	
Th6	Thermistor for discharge pipe temperature	CN_TH2 (Outdoor)

## Refrigerant Pipe Connection Port Diameters

Model	Gas		Liquid	
	mm	inch	mm	inch
S3-W18K233B.AT3GEU1 (K-SAE181A)	Ø 12.7	Ø 1/2	Ø 6.35	Ø 1/4

Appendix	Heat Exchanger	Propeller Fan	Cross Flow Fan	Compressor	Accumulator	4 Way Valve
	EEV (Electronic Expansion Valve)	Capillary Tube	2-Way Valve 3-Way Valve	Temperature Sensor	Pressure Sensor	Pressure Switch
	Check Valve	Flare joint	Muffler	Strainer		

# 4. Wiring Diagram

Indoor Unit : S3NW18K233B.AT3GEU1 (KNSAE181A)

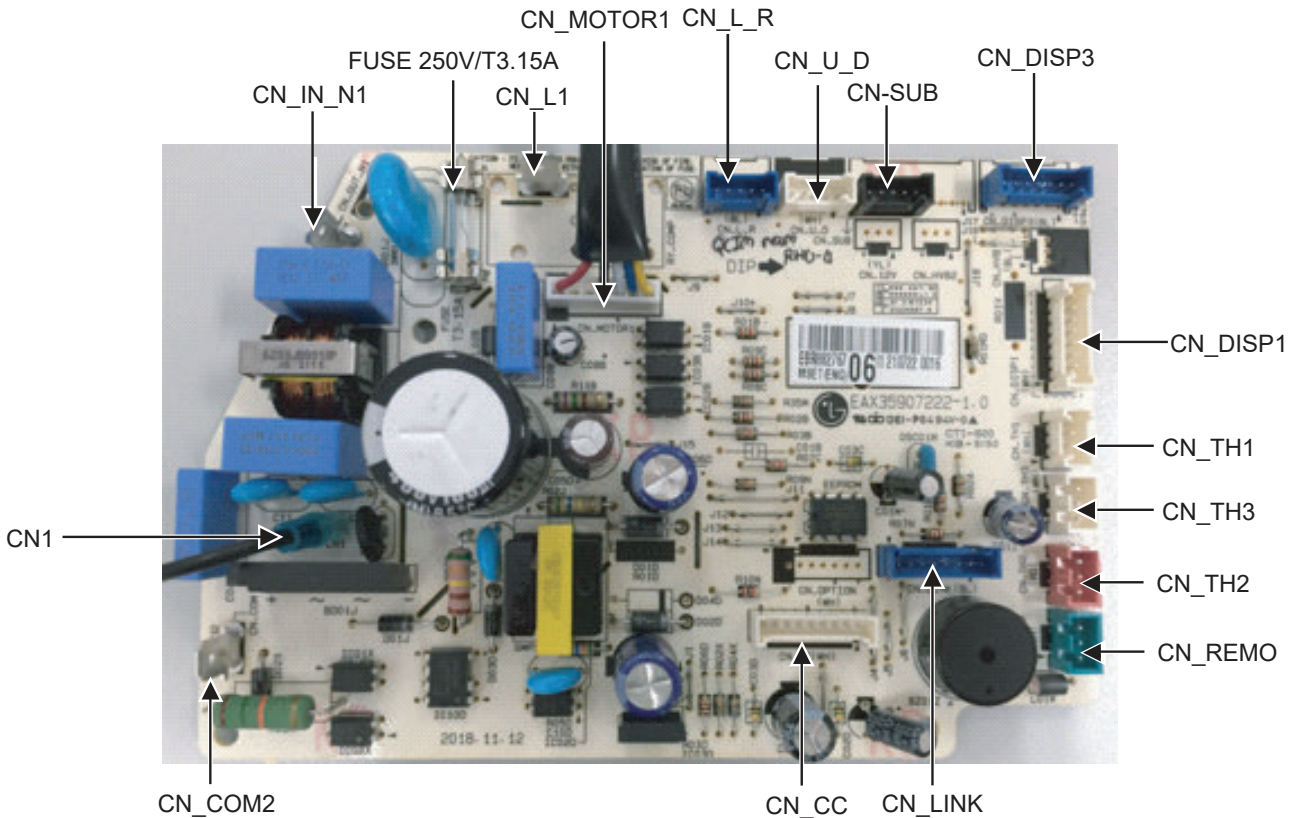
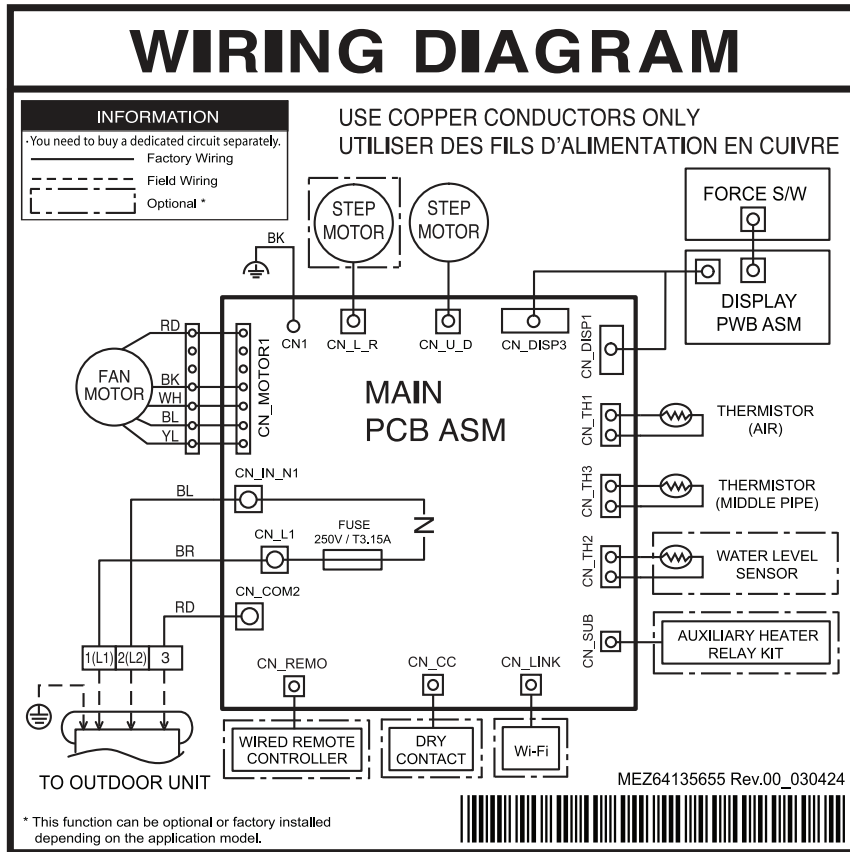

Outdoor Unit : S3UW18K233B.AT3GEU1 (KUSAE181A)

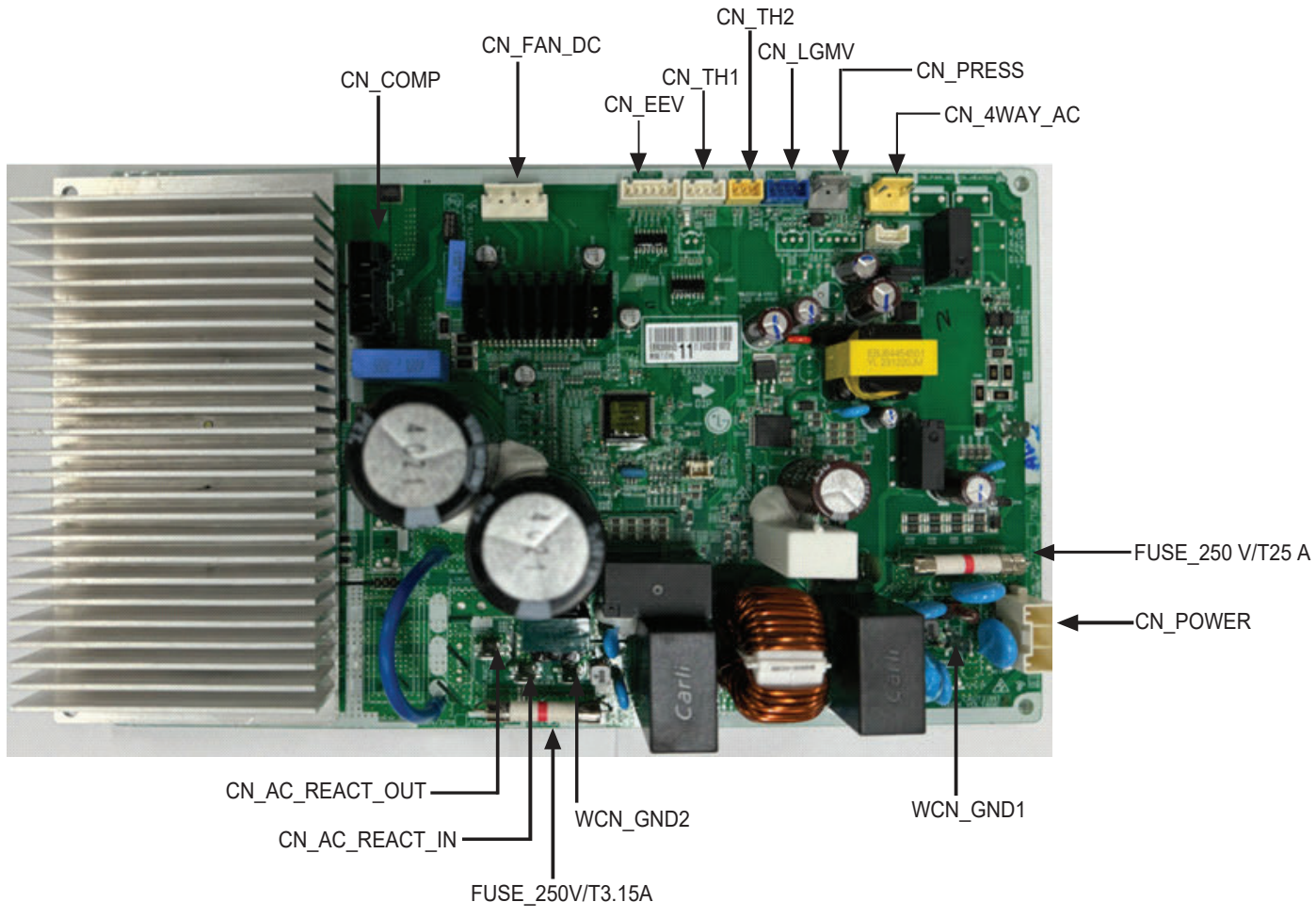
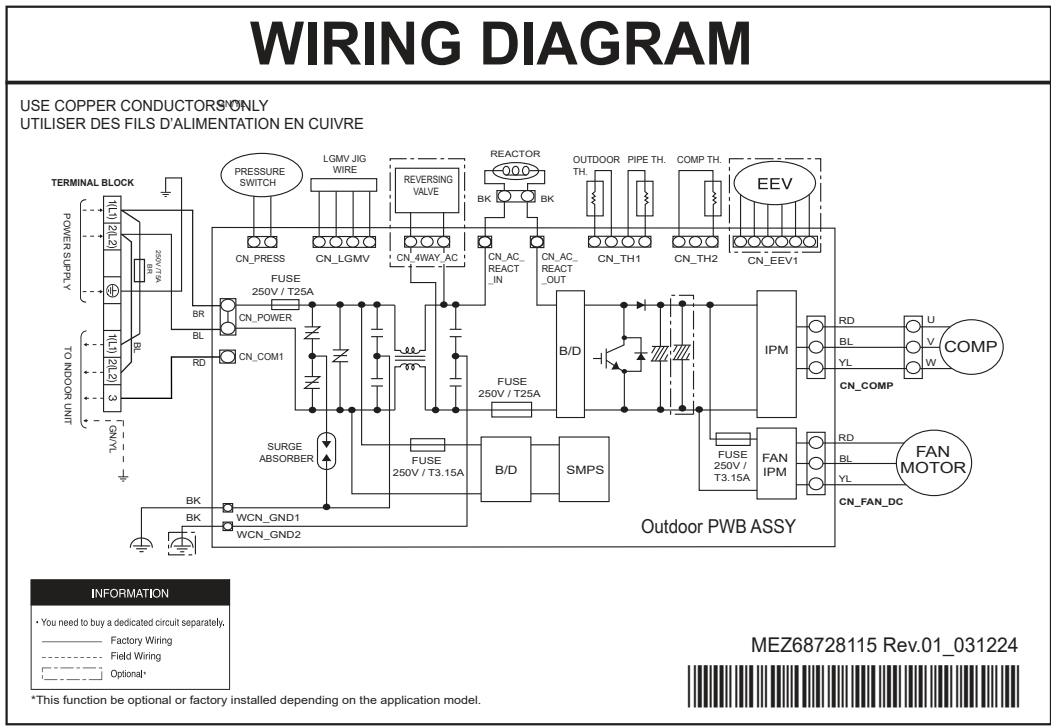

## Change PCB

1. Unscrew the screw to open the plate cover.

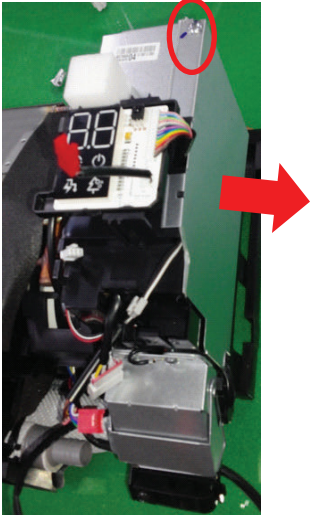

2. Remove the wires from the PCB.  
- Use a long nose, remove easily.



3. Remove the PCB.  
- Push the rib by a long nose remove easily.

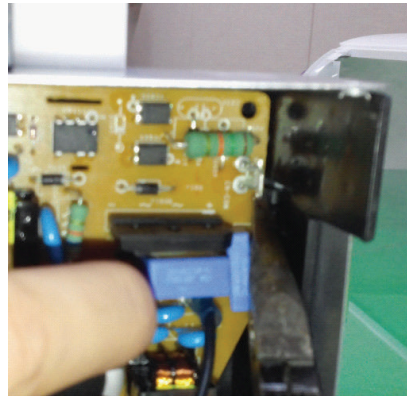
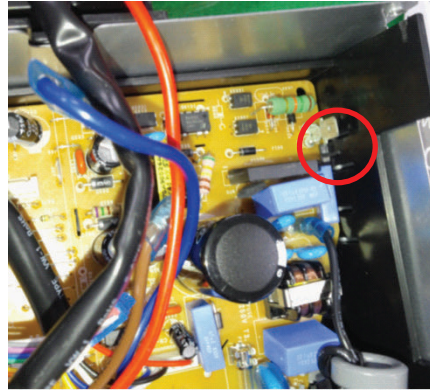

---

## Refrigerant Service

Attaching a silicone(rubber) type red marking to the service port of outdoor unit.

### Service plan

- Red marking can be seen when accessing the service valve to add/remove refrigerant.

(After service, Red marking in reverse order)

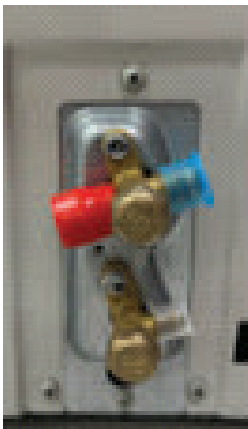

1. Red Marking

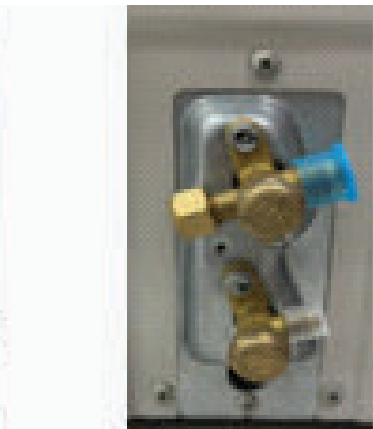

2. Remove Red Mark

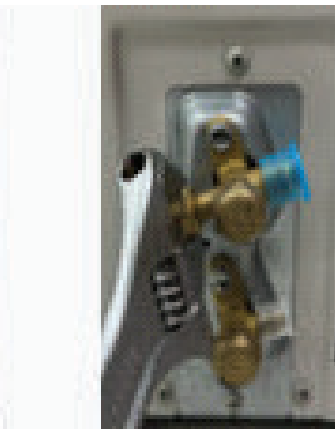

3. Remove Nut

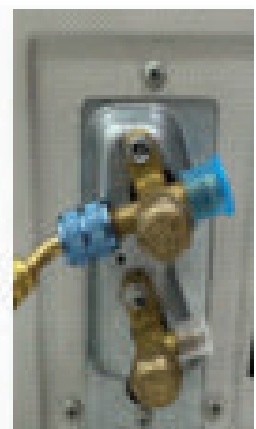

4. Connect Manifold Hose

## 5. Exploded View

Indoor Unit : S3NW18K233B.AT3GEU1 (KNSAE181A)

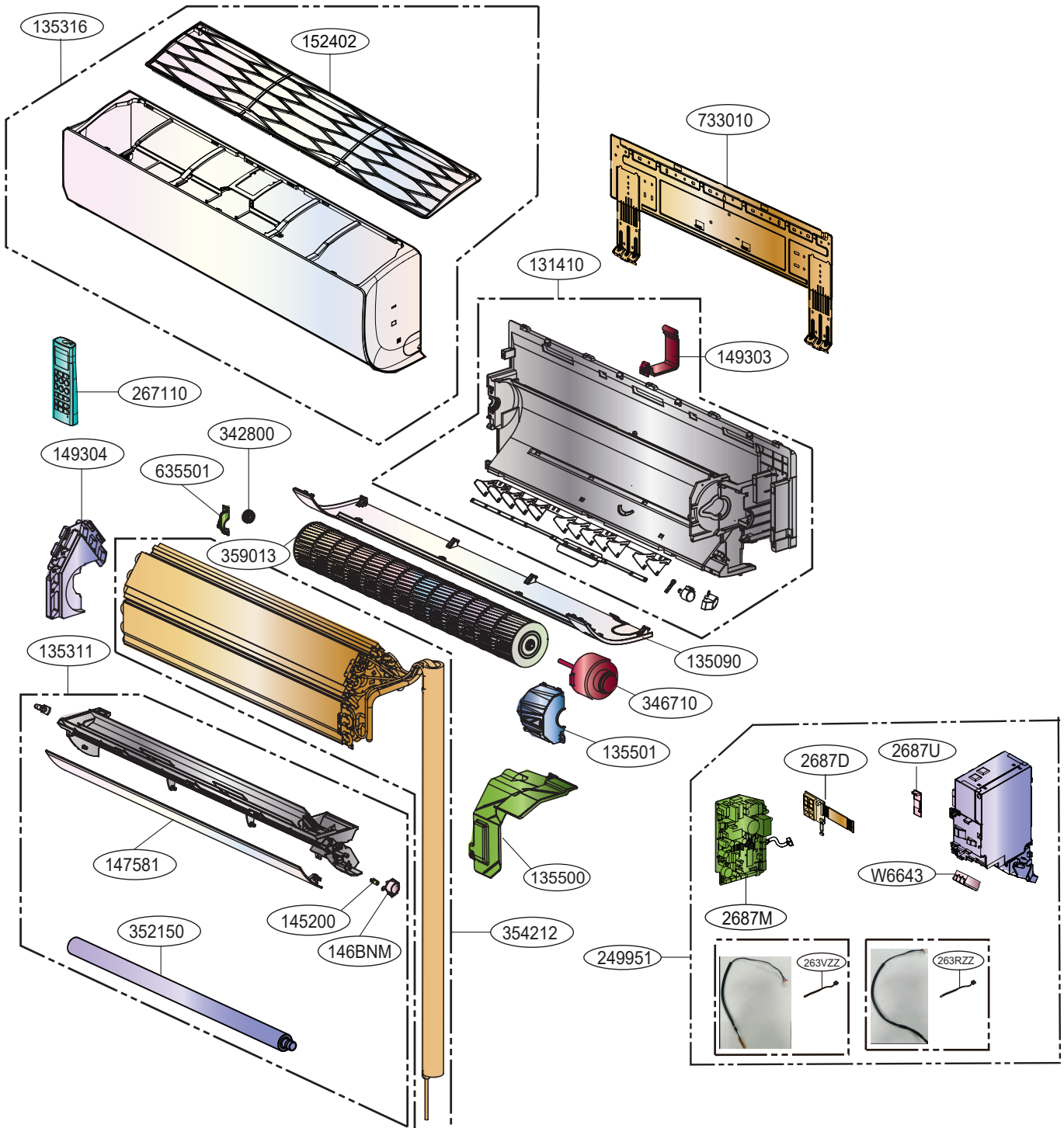

LOC.	Description	PCB Connector
263RZZ	Thermistor for indoor air temperature	CN_TH1 (Indoor)
263VZZ	Thermistor for evaporator temperature	CN_TH3 (Indoor)

# Outdoor Unit : S3UW18K233B.AT3GEU1 (KUSAE181A)

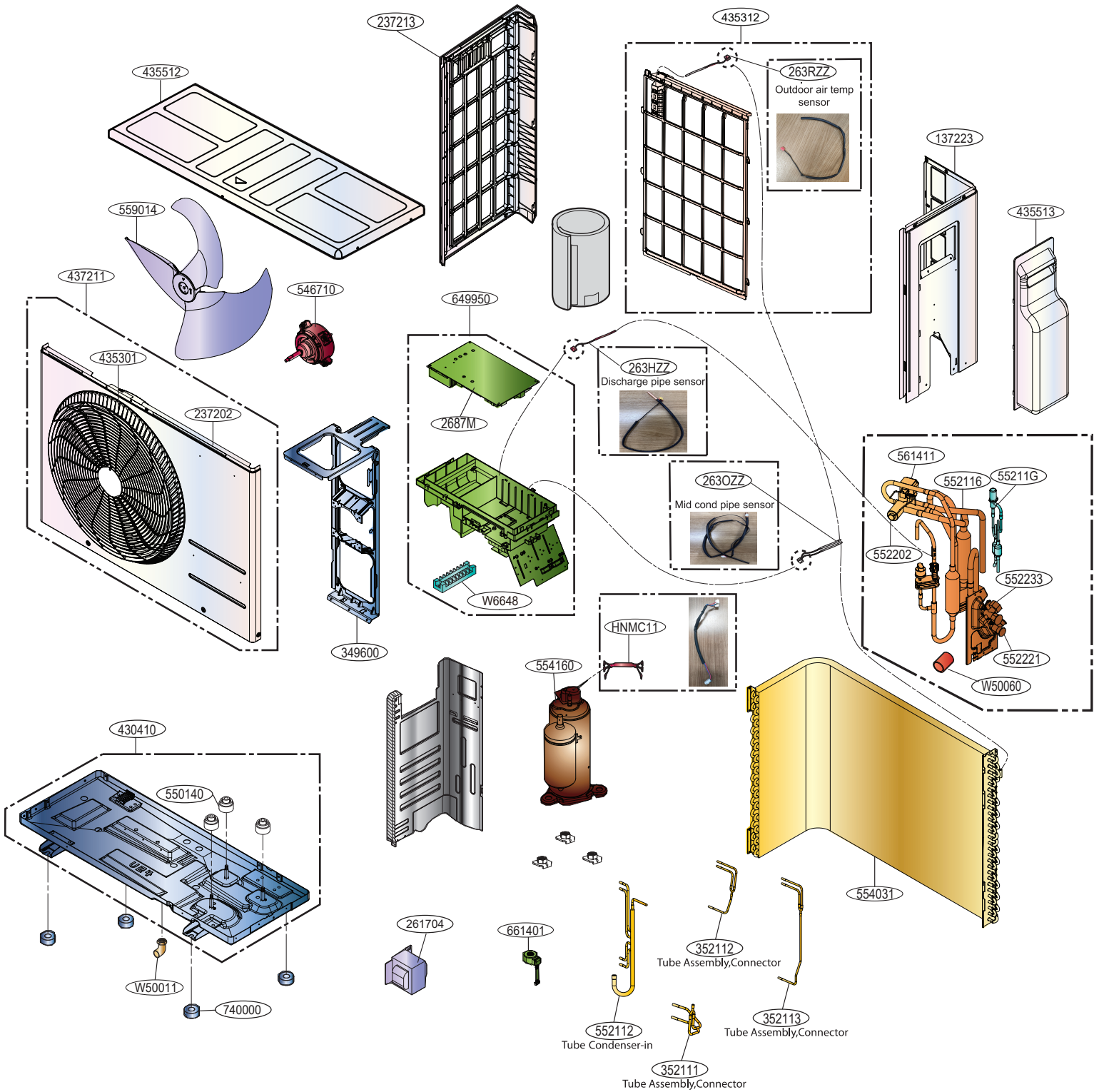

LOC.	Description	PCB Connector
263RZZ	Thermistor for outdoor air temperature	CN_TH1 (Outdoor)
263OZZ	Thermistor for condensing temperature	
263HZZ	Thermistor for discharge pipe temperature	CN_TH2 (Outdoor)



P/NO : MFL72088122

Rev.01\_041725