



RESIDENTIAL & LIGHT COMMERCIAL SYSTEMS

2019

ABOUT LG



About LG Electronics USA

LG Electronics USA, Inc., based in Englewood Cliffs, NJ, is the North American subsidiary of LG Electronics, Inc., a \$54 billion global force and technology leader in consumer electronics, home appliances and mobile communications. LG Electronics, a proud ENERGY STAR® Partner of the Year, sells a range of stylish and innovative home entertainment products, mobile phones, home appliances, commercial displays, air conditioning systems and solar energy solutions in the United States, all under LG's "Life's Good" marketing theme. For more news and information on LG Electronics, please visit www.LG.com.

LG Electronics USA Air Conditioning Technologies

The LG Electronics USA Commercial Air Conditioning business is based in Alpharetta, Ga. LG is a leading player in the global air conditioning market, manufacturing both commercial and residential air conditioners and providing total sustainability and building management solutions. From consumer and individual units to industrial and specialized air conditioning systems, LG provides a wide range of products for heating, ventilating and air conditioning. For more information, please visit www.lghvac.com.

DUCT-FREE SYSTEMS: A NEW WAY TO THINK ABOUT AIR CONDITIONING

LG air conditioning systems are THE smart alternative to traditional air conditioning

For truly personalized comfort in all rooms, consider an LG Duct-Free Split air conditioning system. LG air conditioning systems make it easier to provide customized cooling and heating in every room without any bulky window units or costly ductwork, and with several indoor unit designs sure to match any décor, LG air conditioning systems can be right for every job.



Our Commitment to You:

QUALITY LG air conditioning systems reflect our commitment to building high-quality products. Operating state-of-the-art research & development facilities across the globe, LG invests heavily to ensure we are combining the best technologies with the best ideas.

TRAINING With several LG training academies throughout the United States and even more regional partner academies, LG makes it easy to learn about LG systems and product applications.

PERFORMANCE LG makes a wide range of duct-free products with powerful cooling and heating capabilities while maintaining high energy efficiencies, quiet operation, ease-of-use for personalization of comfort control for the end-user.

INNOVATION LG utilizes smart technology to enhance a homeowner's, and the technician's, experience in operating and providing routine maintenance or service on our air conditioning systems. Our continued efforts to look for the most innovative ideas in HVAC, with our commitment to building green technologies, ensures that we will continue to develop and bring to market smarter, sustainable products.



TABLE OF CONTENTS

INTRODUCTION

About LG	1
LG Advantages	5
Training & Recognition	7
Installation Best Practices	8
Key Features	9

SINGLE ZONE SYSTEMS

Single Zone Line-up	10
Wall Mounted	11
- ART COOL™ Mirror	12
- ART COOL™ Premier	14
- Extended Piping	15
- High Efficiency	16
- Mega 208/230V	16
- Mega 115V	
Ceiling Cassette	17
Low Static Ducted	18
High Static Ducted	19
Vertical AHU	20

Multi-Zone SYSTEMS

Multi-Zone Line-up	21
Outdoor Units	23
Indoor Units	27
Multi F MAX Piping Accessories	31
Multi F Piping Summary	32

ACCESSORIES

Controls	33
Indoor Accessories	34
Outdoor Accessories	35
Air Technologies	35

REFERENCE TABLES

Controls & Accessories Compatibility	36
ENERGY STAR® Systems	38
Model Number Nomenclature	39



LG ADVANTAGES



ROOM-BY-ROOM CONTROL

With a controller for each indoor unit, LG air conditioning systems offer precise temperature settings in each zone while maximizing energy usage by heating or cooling only the zones in use.

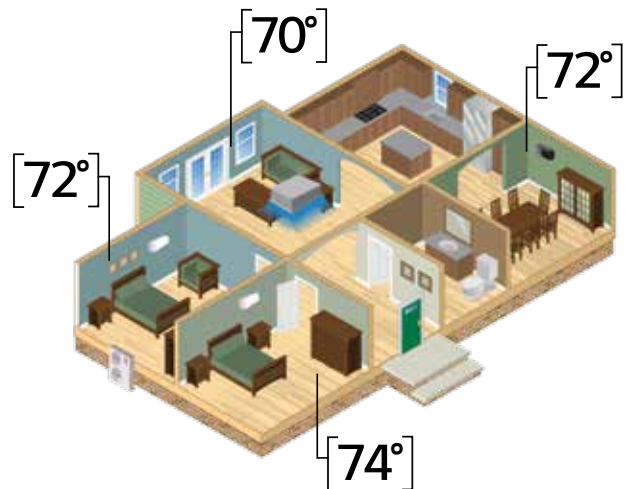

QUIET OPERATION

LG duct-free systems operate at low sound levels, thanks to LG's unique low-vibration compressor, and Brushless Direct Current (BLDC) motor technology that eliminates unnecessary noise and allows for smooth operation.

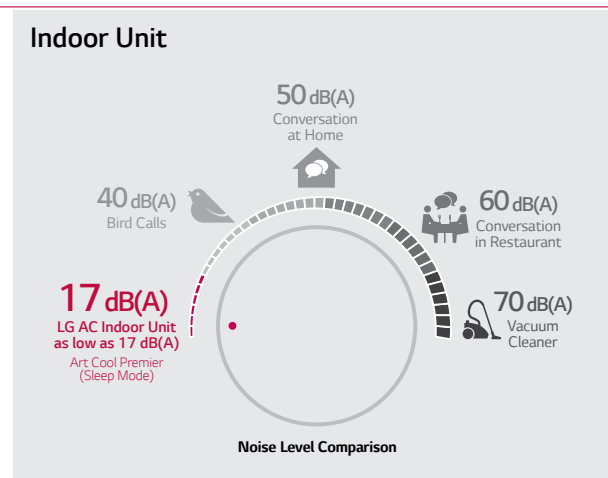

INVERTER TECHNOLOGY

Outdoor units with an inverter, variable-speed, compressor use less energy and are measurably quieter than conventional air conditioner units. Unlike conventional systems that cycle on and off, an inverter compressor ramps up or down to match the capacity needed to maintain comfort levels selected by the homeowner within a conditioned zone.

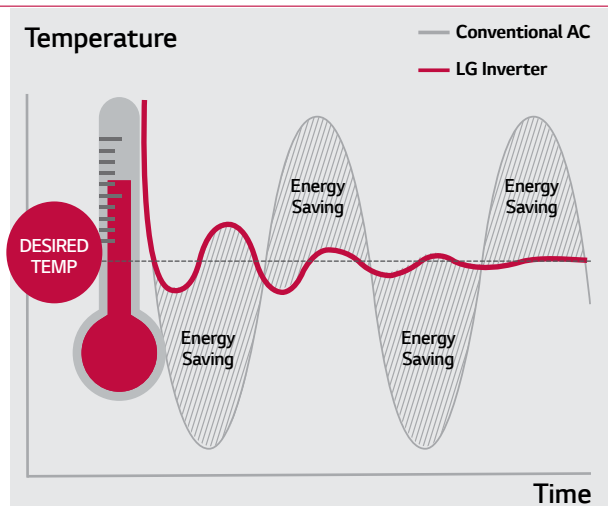

LG ADVANTAGES



LG SMARTTHINQ®

Whenever, wherever and no matter how many air conditioners you have, LG SmartThinQ® let you easily access and control your air conditioner from your compatible smart device.¹



EASY INSTALLATION AND NO DUCTWORK

LG duct-free systems are designed for easier and more efficient installation. They require little to no ductwork, and most indoor units can mount on any wall. Installation requires only a small hole to be drilled in the wall. Smaller indoor and outdoor units ensure space-saving convenience. Moreover, long refrigerant piping lengths increase the distance between the indoor and outdoor units, allowing for extra installation and design flexibility.

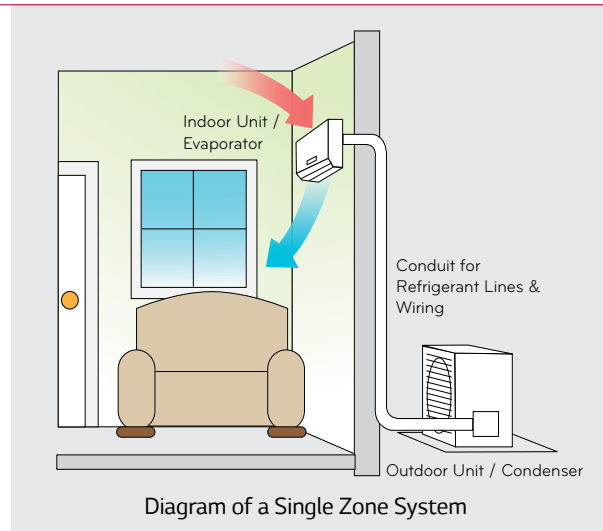

AIR QUALITY

The LG duct-free indoor units utilize 3M™ Micro Protection Filters which reduce dust and microscopic particles including pollen, pet dander and odors. Additional primary filters are washable and antifungal, reducing life-time operation costs. Indoor units also self-clean the coil to protect against mold growth.

Self-Cleaning Indoor Coil

The interior of the air conditioner is maintained by drying off the heat exchanger, eliminating unwanted mold and odors.



MiCRO Dust Filter Powered by 3M Tech

3M Micro Protection Filter, a high air flow filter with low noise, collects harmful microscopic substances including pollen and fine dust.

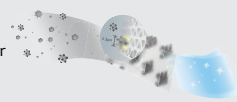

Air Filter

This primary filter captures dust size over 10µm.

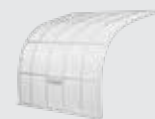

1. LG SmartThinQ® is only available for select models. See product details for full compatibility.

TRAINING & RECOGNITION



Training

The LG US Air Conditioning Technologies division is headquartered near Atlanta in Alpharetta, Ga along with a full training academy. Additional LG Training Academies are located in California, Texas and New Jersey, and we have a number of Partner Academies located throughout the United States. Classes are taught by world-class trainers with years of experience in ductless technology with topics that cover everything from design and specification to installation and service.

For HVAC professionals, LG offers online instruction via our *Learning Management System* and classroom training at our training academies which are placed strategically placed throughout the country. Training is open to all contractors; ask your LG Electronics authorized distributor for details.

For more information and to find out how you can be part of the next training class near you, visit training.lghvac.com

Service Tools

As part of our commitment to innovation, LG has developed innovative ways to enhance the service technician's experience during routine maintenance or service with these tools:

- **LG SIMS (Smart Inverter Monitoring System)** connects to select outdoor units and allows technicians to troubleshoot accurately by interfacing directly with the unit and following step-by-step troubleshooting guidelines. This is a free smartphone app developed by LG factory engineers.
- **LG Telepresence** connects technicians in the field directly to LG Technical Assistance representatives via a live video feed through the technician's smartphone, allowing you to bring LG technical support with you to any jobsite.



TAKE YOUR BUSINESS TO NEW LEVELS

The LG Excellence Contractor Program provides specialized support and recognition for contractors who have been trained by factory teams to install LG Residential and Light Commercial Systems, helping to set contractors apart from your competitors. Along with great incentives and recognition, the LG Excellence Contractor Program provides an enhanced warranty, a website listing with LG Excellence designation on the LG website's contractor locator, consumer lead referrals and local advertising materials. To find out how to put these tools to work for you, visit lghvac.com/excellence

INSTALLATION BEST PRACTICES

For jobs small to large, look for opportunities to use LG comfort systems everywhere! Explore the many applications of LG Single and Multi-Zone systems: whole home renovations, older system replacements, home additions, energy savings opportunities, hot or cold zones ... and many, many more!

System sizing and installation accuracy are key factors for the optimal performance of a LG comfort system. Increased energy efficiency, customizable design aesthetics and room by room comfort control are just a few of the benefits that come from a properly installed system. Products should be installed in accordance with LG installation manuals and in compliance with applicable state and local codes.

Below are a few of the best practices used by Excellence Contractors across the U.S. during installation:

Unit Placement (Indoor & Outdoor)

- Leave appropriate clearances on all sides of the indoor and outdoor units to allow for proper airflow as well as service access
- Include space for drainage to ensure condensate flows properly out of the unit
- Units should be properly anchored to prevent unnecessary vibrations

Additionally for indoor units:

- Keep unit away from any indoor steam or excessive heat
- No obstacles should be placed around unit
- Do not install near a doorway or over a window
- Condensation drain should be routed away from the indoor unit to the outside

Wiring

- Use wire that fulfills or exceeds the minimum wire requirements:
 - Multi F MAX to BD unit: 14-4
 - All other wiring: 14-4
- L1 and L2 are polarity sensitive on all models
- Indoor units are 208/230 volts (or 115 volt on two Mega models)
- Terminal 3 is 115 volt
- Never use wire nuts or splices in wiring
- Use non-insulated spade connectors on all terminal connections
- Use a JIS screwdriver on terminal block to avoid stripping out the screws
- Only a dedicated electrical circuit is allowed
- Always ground indoor and outdoor unit
- Only connect one (1) end of the shielded cable if using shielded wire

***NOTE* All wiring must comply with applicable local and national codes.**

Piping

- Use only the correct line sizes as determined by the indoor unit
- Use only copper refrigerant piping
- Insulate both refrigerant lines independently of each other
- Flare connections using a 45-degree flaring tool
- Consider Flaretite fittings for all connections and torque flares to specs
- Do not exceed the maximum pipe length or install less than the required minimum
- Do not make vertical loops in the refrigerant piping
- Support pipe runs from sagging or bending

Charging

- Leak test with dry nitrogen to at least 550 p.s.i.
- Never use anything but soap bubbles designed for HVAC leak testing
- Use only an approved evacuation hose for proper evacuation and leak testing
- If possible, remove cores from system prior to starting evacuation
- Start with fresh vacuum pump oil and evacuate to less than 500 microns
- If refrigerant is added, use an electronic scale and weigh in the precise amount
- Open service valves prior to energizing the unit

Installation and Service Tools:

- Quality Flaring Tool
- Digital Refrigerant Charging Scale
- Torque Wrench
- JIS Screwdriver
- Micron Gauge
- Vacuum Pump
- High-Quality Multimeter



KEY FEATURES



LGRED° HEAT TECHNOLOGY

Advanced technology that can exceed 100% of the rated heating capacity performance down to 5° F and continuous heating performance down to -13° F.

LGRED°
Powerful Heat Technology
RELIABLE TO EXTREME DEGREES



DEHUMIDIFYING MODE

Uses sensors in the indoor unit to accurately measure room temperature and control humidity by adjusting the set point and fan speed.



OPTIMIZED AIRFLOW



Jet Cool / Jet Heat Mode operates the unit at a high speed for up to 30 minutes to quickly cool or heat a room.

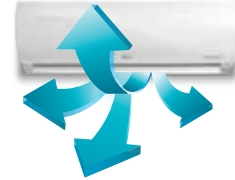

Swirl Wind / Chaos Wind allows for customized louver and fan speed operation to create a stronger, wider airflow for reduced temperature stratification and to provide more natural air circulation.



Auto Operation adjusts the temperature and fan speed automatically to match the user's preference from three levels of comfort.



Art Cool™ Gallery 3D Airflow uniquely provides three-directional airflow for more natural and effective air circulation.



GOLD FIN

Gold Fin™ Coating is an anticorrosion coating to help protect your system from corrosive elements, allowing the coil to maintain excellent heat transfer properties for an extended time.



DEFROST CONTROL

Removes frost from the outdoor coil when ambient outdoor temperatures are low and simultaneously shuts down the indoor fan to prevent cold air from being blown into the controlled space.



AUTO SLEEP MODE

Automatically increases the temperature setting 2° F twice in 30 minute increments. The indoor unit shuts off when the timer setting is reached.



AUTO RESTART

Automatically restarts the system after a power failure.

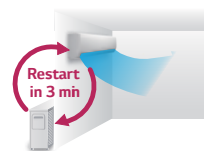



















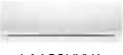
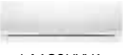
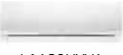

















STYLISH DESIGN

LG air conditioning systems come in a variety of indoor units, including the Art Cool™ Gallery, which includes a panel that works like a customizable picture frame. For Multi F systems, choose from different capacities to match load demands appropriately while maintaining the aesthetic of any room's décor.



SINGLE ZONE SYSTEMS

Lineup

		Btu/h	9,000	12,000	15,000	18,000	24,000	30,000	36,000	42,000	48,000
Wall Mounted	ART COOL™ Mirror										
		LA090HSV5	LA120HSV5			LA180HSV5					
	ART COOL™ Premier										
		LA090HYV1	LA120HYV1	LA150HYV2	LA180HYV2	LA240HYV1					
											
											
											
	Extended Piping										
							LS243HLV	LS303HLV	LS363HLV		
	High Efficiency										
		LS090HSV5	LS120HSV5			LS180HSV5					
	Mega 208/230V										
		LS090HEV2	LS120HEV2			LS180HEV2	LS240HEV2				
	Mega 115V										
		LS090HXV2	LS120HXV2								
Ceiling Mounted	Ceiling Cassette										
		LC098HV4	LC128HV4			LC188HV4	LC248HV		LC368HV	LC428HV	
Ducted	High Static										
							LH248HV4		LH368HV4		
	Low Static										
		LD097HV4	LD127HV4			LD187HV4					
	Vertical AHU										
						LV181HV4	LV241HV4		LV361HV4	LV420HV	LV480HV

ART COOL™ MIRROR



LA090HSV5
LA120HSV5
LA180HSV5



Specification	Unit	LA090HSV5	LA120HSV5	LA180HSV5	
Indoor Unit		LAN090HSV5	LAN120HSV5	LAN180HSV5	
Outdoor Unit		LSU090HSV5	LSU120HSV5	LSU180HSV5	
Capacity ^{1,2}	Rated Cooling Capacity	Btu/h	9,000	12,000	18,000
	Cooling Capacity Range	Btu/h	1,023 - 12,625	1,023 - 13,785	3,070 - 29,515
	Rated Heating Capacity	Btu/h	10,900	13,600	21,600
	Heating Capacity Range	Btu/h	1,023 - 17,061	1,023 - 22,178	3,070 - 38,898
	Max Heating Capacity at 17°F	Btu/h	11,080	13,810	22,340
	Max Heating Capacity at 5°F	Btu/h	9,570	11,930	19,300
	Max Heating Capacity at -4°F	Btu/h	8,310	10,360	16,760
	SEER, EER	Btu/h	23.5, 14.52	22.7, 12.5	21.5, 12.58
Power	HSPF		11.3	11.4	10.2
	Voltage (IDU)	V-Ø - Hz	208/230-1-60	208/230-1-60	208/230-1-60
	Voltage (ODU)	V-Ø - Hz	208/230-1-60	208/230-1-60	208/230-1-60
	Cooling Power Input	kW	0.62	0.96	1.43
	Heating Power Input	kW	0.71	1.04	1.73
	MCA, MOCP	A	10, 15	10, 15	13, 20
	Power/Communication Wiring ³	No. x AWG	4 x 14	4 x 14	4 x 14
	Rated Amps (Cool/Heat)	A	7.4/7.4	7.4/7.4	9.85/9.85
Operation Range	Heating Operation Range	°F WB	-4 - 65	-4 - 65	-4 - 65
	Cooling Operation Range	°F DB	14 - 118	14 - 118	14 - 118
	Optional Wind Baffle ⁴		ZLABGP01A (0°F)	ZLABGP01A (0°F)	ZLABGP02A (0°F)
	IDU Operation Range Cooling	°F	53 - 75	53 - 75	53 - 75
	IDU Operation Range Heating	°F	60 - 86	60 - 86	60 - 86
	Setpoint Range Cooling	°F	64 - 86	64 - 86	64 - 86
	Setpoint Range Heating	°F	60 - 86	60 - 86	60 - 86
Dimensions	IDU Dimensions (WxHxD)	in	32-15/16 x 12-1/8 x 7-9/16	32-15/16 x 12-1/8 x 7-9/16	39-9/32 x 13-19/32 x 8-11/32
	ODU Dimensions (WxHxD)	in	30-5/16 x 21-1/2 x 11-5/16	30-5/16 x 21-1/2 x 11-5/16	34-1/4 x 31-1/2 x 12-19/32
Weight	IDU Weight (Net/Shipping)	lbs	20.5 / 25.6	20.5 / 25.6	29.8 / 36.4
	ODU Weight (Net/Shipping)	lbs	74.1 / 78.9	74.1 / 78.9	116.8 / 126.5
Unit Data	Airflow (Max/H/M/L) ⁵	CFM	459 / 338 / 317 / 194	459 / 338 / 317 / 194	706 / 530 / 477 / 371
	Dehumidification	pts/hr	2.7	2.7	5.5
	Compressor Type		Twin Rotary	Twin Rotary	Twin Rotary
	Refrigerant Type		R410A	R410A	R410A
Sound Pressure ⁶	Indoor (H/M/L/SL)	dB(A)	39 / 33 / 23 / 19	39 / 33 / 23 / 19	45 / 40 / 35 / 29
	Outdoor Max	dB(A)	48	48	53
Piping ⁷	Liquid Pipe	in	1/4	1/4	3/8
	Vapor Pipe	in	3/8	3/8	5/8
	Pipe Length (Min/Max)	ft	9.8 / 82	9.8 / 82	9.8 / 114.8
	Max Pipe Elevation	ft	49.2	49.2	49.2
	Precharge Pipe Length	ft	41	41	24.6
	Additional Refrigerant	oz/ft	0.22	0.22	0.38
	Drain (OD, ID)	in	27/32, 5/8	27/32, 5/8	27/32, 5/8
Controller	Supplied		AKB74955602	AKB74955602	

Note:

- Rated capacity at 0 ft. above sea level with 25 ft. of refrigerant line and a 0 ft. level difference between outdoor and indoor unit.
- Rated cooling capacity obtained with air entering the indoor unit at 80°F dry bulb (DB) and 67°F wet bulb (WB) and outdoor ambient conditions of 95°F dry bulb (DB) and 75°F wet bulb (WB).
Rated heating capacity obtained with air entering the indoor unit at 70°F dry bulb (DB) and 60°F wet bulb (WB) and outdoor ambient conditions of 47°F dry bulb (DB) and 43°F wet bulb (WB).
For capacity information, see engineering manual capacity tables.
- All power/communication wiring minimum 4-conductor, stranded, shielded, and must comply with applicable local and national codes.
- Installation of an optional Low Ambient Wind Baffle Kit will allow operation down to 0°F in cooling mode for applicable outdoor units.
- Airflow shown is in cooling mode.
- Sound pressure levels are tested in an anechoic chamber under ISO Standard 3745 and are the same in both cooling and heating mode. These values can increase due to ambient conditions during operation.
- Piping lengths are equivalent.
- Due to our commitment to continued innovation, some specifications may be changed without notification.

ART COOL™ PREMIER with LGRED° heat

SINGLE ZONE



LGRED°



LA090HYV1
LA120HYV1
LA150HYV2
LA180HYV2



Specification	Unit	LA090HYV1	LA120HYV1	LA150HYV2	LA180HYV2
Indoor Unit		LAN090HYV1	LAN120HYV1	LAN150HYV2	LAN180HYV2
Outdoor Unit		LAU090HYV1	LAU120HYV1	LAU150HYV2	LAU180HYV2
Rated Cooling Capacity	Btu/h	9,000	11,000	15,000	18,200
Cooling Capacity Range	Btu/h	1,023 - 12,966	1,023 - 13,785	3,070 - 21,000	3,070 - 29,515
Rated Heating Capacity	Btu/h	11,000	12,000	18,000	22,000
Heating Capacity Range	Btu/h	1,023 - 20,472	1,023 - 22,178	3,070 - 25,200	3,070 - 32,000
Max Heating Capacity at 17°F	Btu/h	11,940	14,650	21,430	27,400
Max Heating Capacity at 5°F	Btu/h	11,220	13,720	18,950	24,360
Max Heating Capacity at -13°F	Btu/h	7,920	9,520	14,660	19,120
SEER, EER		27.5, 15.65	25.5, 13.75	24.0, 13.48	22.0, 12.5
HSPF		12	12	12.5	12.0
Voltage (IDU)	V, Ø, Hz	208/230-1-60	208/230-1-60	208/230-1-60	208/230-1-60
Voltage (ODU)	V, Ø, Hz	208/230-1-60	208/230-1-60	208/230-1-60	208/230-1-60
Cooling Power Input	kW	0.58	0.8	1.11	1.46
Heating Power Input	kW	0.71	0.75	1.39	1.79
MCA, MOCP	A	11.2, 15	11.2, 15	19.0, 25	19.0, 25
Power/Communication Wiring ⁴	No. x AWG	4 x 14	4 x 14	4 x 14	4 x 14
Rated Amps Cool/Heat	A	8.7/8.7	8.7/8.7	15.0/15.0	15.0/15.0
Heating Operation Range	°F WB	-13 - 65	-13 - 65	-13-65	-13-65
Cooling Operation Range	°F DB	14-118	14-118	14-118	14-118
Optional Wind Baffle ⁶		ZLABGP01A (0°F)	ZLABGP01A (0°F)	ZLABGP02A (0°F)	ZLABGP02A (0°F)
IDU Operation Range Cooling	°F WB	53 - 75	53 - 75	53 - 75	53 - 75
IDU Operation Range Heating	°F DB	60 - 86	60 - 86	60 - 86	60 - 86
Setpoint Range Cooling	°F	64 - 86	64 - 86	64 - 86	64 - 86
Setpoint Range Heating	°F	60 - 86	60 - 86	60 - 86	60 - 86
IDU Dimensions (WxHxD)	in	34-7/16x11-5/8x9-1/4	34-7/16x11-5/8x9-1/4	42-15/16x12-31/32x9-25/32	42-15/16x12-31/32x9-25/32
ODU Dimensions (WxHxD)	in	30-5/16x21-1/2x11-5/16	30-5/16x21-1/2x11-5/16	34-1/4 x 31-1/2 x 12-19/32	34-1/4 x 31-1/2 x 12-19/32
IDU Weight (Net/Shipping)	lbs	24/30	24/30	34/38	34/38
ODU Weight (Net/Shipping)	lbs	77/82	77/82	122/131	122/131
Airflow (Max/H/M/L)	CFM	547/494/417/283	547/494/417/283	742/565/424/318	777/565/424/318
Dehumidification	pts/hr	3.20	3.60	3.80	4.60
Compressor Type		Twin Rotary	Twin Rotary	Twin Rotary	Twin Rotary
Refrigerant Type		R410A	R410A	R410A	R410A
Indoor (H/M/L/SL)	dB(A)	42/36/25/17	42/36/25/17	47/42/37/29	47/42/37/29
Outdoor Max	dB(A)	45	45	57	57
Liquid Pipe	in	1/4	1/4	3/8	3/8
Vapor Pipe	in	3/8	3/8	5/8	5/8
Pipe Length (Min/Max)	ft	6.6/65.6	6.6/65.6	9.8/98.4	9.8/98.4
Max Pipe Elevation	ft	32.8	32.8	65.6	65.6
Precharge Pipe Length	ft	41	41	24.6	24.6
Additional Refrigerant	oz/ft	0.22	0.22	0.38	0.38
Drain (OD, ID)	in	27/32, 5/8	27/32, 5/8	27/32, 5/8	27/32, 5/8
Controller	Supplied	AKB73835320	AKB73835320	AKB74955602	AKB74955602

Note:

- Rated capacity at 0 ft. above sea level with 25 ft. of refrigerant line and a 0 ft. level difference between outdoor and indoor unit.
- Rated cooling capacity obtained with air entering the indoor unit at 80°F dry bulb (DB) and 67°F wet bulb (WB) and outdoor ambient conditions of 95°F dry bulb (DB) and 75°F wet bulb (WB).
Rated heating capacity obtained with air entering the indoor unit at 70°F dry bulb (DB) and 60°F wet bulb (WB) and outdoor ambient conditions of 47°F dry bulb (DB) and 43°F wet bulb (WB).
For capacity information, see engineering manual capacity tables.
- All power/communication wiring minimum 4-conductor, stranded, shielded, and must comply with applicable local and national codes.
- Installation of an optional Low Ambient Wind Baffle Kit will allow operation down to 0°F in cooling mode for applicable outdoor units.
- Airflow shown is in cooling mode.
- Sound pressure levels are tested in an anechoic chamber under ISO Standard 3745 and are the same in both cooling and heating mode. These values can increase due to ambient conditions during operation.
- Piping lengths are equivalent.
- Due to our commitment to continued innovation, some specifications may be changed without notification.

ART COOL™ PREMIER

LA180HYV1
LA240HYV1



Specification	Unit	LA180HYV1	LA240HYV1
Indoor Unit		LAN180HYV1	LAN240HYV1
Outdoor Unit		LAU180HYV1	LAU240HYV1
Rated Cooling Capacity	Btu/h	18,200	22,000
Cooling Capacity Range	Btu/h	3,070 - 29,515	3,070 - 30,000
Rated Heating Capacity	Btu/h	22,000	27,000
Heating Capacity Range	Btu/h	3,070 - 30,709	3,070 - 35,200
Max Heating Capacity at 17°F	Btu/h	22,340	27,410
Max Heating Capacity at 5°F	Btu/h	19,300	23,690
Max Heating Capacity at -13°F	Btu/h	14,060	17,250
SEER, EER		24, 13.48	22, 12.5
HSPF		13	12.3
Voltage (IDU)	V, Ø, Hz	208-230, 1, 60	208-230, 1, 60
Voltage (ODU)	V, Ø, Hz	208-230, 1, 60	208-230, 1, 60
Cooling Power Input	kW	1.35	1.76
Heating Power Input	kW	1.69	2.19
MCA, MOCP	A	19, 25	19, 25
Power/Communication Wiring ³	No. x AWG	4 x 14	4 x 14
Rated Amps Cool/Heat	A	15.3/15.3	15.3/15.3
Heating Operation Range	°F WB	-13 - 65	-13 - 65
Cooling Operation Range	°F DB	14 - 118	14 - 118
Optional Wind Baffle ⁴		ZLABGP02A (0°F)	ZLABGP02A (0°F)
IDU Operation Range Cooling	°F WB	53 - 75	53 - 75
IDU Operation Range Heating	°F DB	60 - 86	60 - 86
Setpoint Range Cooling	°F	64 - 86	64 - 86
Setpoint Range Heating	°F	60 - 86	60 - 86
IDU Dimensions (WxHxD)	in	42-15/16 x 12-31/32 x 9-25/32	42-15/16 x 12-31/32 x 9-25/32
ODU Dimensions (WxHxD)	in	34-1/4 x 31-1/2 x 12-19/32	34-1/4 x 31-1/2 x 12-19/32
IDU Weight (Net/Shipping)	lbs	34/38	34/38
ODU Weight (Net/Shipping)	lbs	122/131	122/131
Airflow (Max/H/M/L)	CFM	742/565/424/318	777/565/424/318
Dehumidification	pts/hr	3.80	4.70
Compressor Type		Twin Rotary	Twin Rotary
Refrigerant Type		R-410A	R-410A
Indoor (H/M/L/SL)	dB(A)	47/42/37/29	47/42/37/29
Outdoor Max	dB(A)	57	57
Liquid Pipe	in	3/8	3/8
Vapor Pipe	in	5/8	5/8
Pipe Length (Min/Max)	ft	9.8/98.4	9.8/98.4
Max Pipe Elevation	ft	65.6	65.6
Precharge Pipe Length	ft	24.6	24.6
Additional Refrigerant	oz/ft	0.38	0.38
Drain (OD, ID)	in	27/32, 5/8	27/32, 5/8
Controller	Supplied	AKB74835304	AKB74835304

Note:

- Rated capacity at 0 ft. above sea level with 25 ft. of refrigerant line and a 0 ft. level difference between outdoor and indoor unit.
- Rated cooling capacity obtained with air entering the indoor unit at 80°F dry bulb (DB) and 67°F wet bulb (WB) and outdoor ambient conditions of 95°F dry bulb (DB) and 75°F wet bulb (WB).
Rated heating capacity obtained with air entering the indoor unit at 70°F dry bulb (DB) and 60°F wet bulb (WB) and outdoor ambient conditions of 47°F dry bulb (DB) and 43°F wet bulb (WB).
For capacity information, see engineering manual capacity tables.
- All power/communication wiring minimum 4-conductor, stranded, shielded, and must comply with applicable local and national codes.
- Installation of an optional Low Ambient Wind Baffle Kit will allow operation down to 0°F in cooling mode for applicable outdoor units.
- Airflow shown is in cooling mode.
- Sound pressure levels are tested in an anechoic chamber under ISO Standard 3745 and are the same in both cooling and heating mode. These values can increase due to ambient conditions during operation.
- Piping lengths are equivalent.
- Due to our commitment to continued innovation, some specifications may be changed without notification.

EXTENDED PIPING



LS243HLV
LS303HLV
LS363HLV



Specification	Unit	LS243HLV	LS303HLV	LS363HLV
Indoor Unit		LSN243HLV	LSN303HLV	LSN363HLV
Outdoor Unit		LSU243HLV	LSU303HLV	LSU363HLV
Rated Cooling Capacity	Btu/h	22,000	30,000	33,000
Cooling Capacity Range	Btu/h	3,070 - 29,515	3,070 - 34,000	3,070 - 34,000
Rated Heating Capacity	Btu/h	27,000	32,000	35,200
Heating Capacity Range	Btu/h	3,070 - 38,898	3,070 - 38,898	3,070 - 38,898
Max Heating Capacity at 17°F	Btu/h	27,410	32,490	35,740
Max Heating Capacity at 5°F	Btu/h	23,690	28,080	30,890
Max Heating Capacity at -4°F	Btu/h	20,580	24,390	26,820
SEER, EER		21.5, 12.5	19.0, 10.0	17.5, 8.18
HSPF		11	10.0	10
Voltage (IDU)	V, Ø, Hz	208/230-1-60	208/230-1-60	208/230-1-60
Voltage (ODU)	V, Ø, Hz	208/230-1-60	208/230-1-60	208/230-1-60
Cooling Power Input	kW	1.76	3.00	4.04
Heating Power Input	kW	2.38	3.10	3.84
MCA, MOCP	A	19, 30	19, 30	19, 30
Recommended Fuse	A	25	25	25
Power/Communication Wiring ³	No. x AWG	4 x 14	4 x 14	4 x 14
Rated Amps Cool/Heat	A	14.85/14.85	14.85/14.85	14.85/14.85
Heating Operation Range	°F WB	-4 - 65	-4 - 65	-4 - 65
Cooling Operation Range	°F DB	14 - 118	14 - 118	14 - 118
Optional Wind Baffle ⁴		ZLABGP02A (0°F)	ZLABGP02A (0°F)	ZLABGP02A (0°F)
IDU Operation Range Cooling	°F WB	53 - 75	53 - 75	53 - 75
IDU Operation Range Heating	°F DB	60 - 86	60 - 86	60 - 86
Setpoint Range Cooling	°F	64 - 86	64 - 86	64 - 86
Setpoint Range Heating	°F	60 - 86	60 - 86	60 - 86
IDU Dimensions (WxHxD)	in	46-7/8x13-5/8x10-7/16	46-7/8x13-5/8x10-7/16	46-7/8x13-5/8x10-7/16
ODU Dimensions (WxHxD)	in	34-1/4x31-1/2x12-19/32	34-1/4x31-1/2x12-19/32	34-1/4x31-1/2x12-19/32
IDU Weight (Net/Shipping)	lbs	40/46	40/46	40/46
ODU Weight (Net/Shipping)	lbs	125/133	125/133	125/133
Airflow (Max/H/M/L) ⁵	CFM	953/848/706/530	953/848/706/530	953/848/706/530
Dehumidification	pts/hr	5.5	5.9	6.6
Compressor Type		Twin Rotary	Twin Rotary	Twin Rotary
Refrigerant Type		R410A	R410A	R410A
Indoor (H/M/L/SL)	dB(A)	49/44/40/37	49/44/40/37	49/44/40/37
Outdoor Max	dB(A)	55	55	55
Liquid Pipe	in	3/8	3/8	3/8
Vapor Pipe	in	5/8	5/8	5/8
Pipe Length (Min/Max)	ft	9.84/164	9.84/164	9.84/164
Max Pipe Elevation	ft	98.4	98.4	98.4
Precharge Pipe Length	ft	24.6	24.6	24.6
Additional Refrigerant	oz/ft	0.38	0.38	0.38
Drain (OD, ID)	in	27/32, 5/8	27/32, 5/8	27/32, 5/8
Controller	Supplied	AKB74955602	AKB74955602	AKB74955602

Note:

- Rated capacity at 0 ft. above sea level with 25 ft. of refrigerant line and a 0 ft. level difference between outdoor and indoor unit.
- Rated cooling capacity obtained with air entering the indoor unit at 80°F dry bulb (DB) and 67°F wet bulb (WB) and outdoor ambient conditions of 95°F dry bulb (DB) and 75°F wet bulb (WB).
Rated heating capacity obtained with air entering the indoor unit at 70°F dry bulb (DB) and 60°F wet bulb (WB) and outdoor ambient conditions of 47°F dry bulb (DB) and 43°F wet bulb (WB).
For capacity information, see engineering manual capacity tables.
- All power/communication wiring minimum 4-conductor, stranded, shielded, and must comply with applicable local and national codes.
- Installation of an optional Low Ambient Wind Baffle Kit will allow operation down to 0°F in cooling mode for applicable outdoor units.
- Airflow shown is in cooling mode.
- Sound pressure levels are tested in an anechoic chamber under ISO Standard 3745 and are the same in both cooling and heating mode. These values can increase due to ambient conditions during operation.
- Piping lengths are equivalent.
- Due to our commitment to continued innovation, some specifications may be changed without notification.

HIGH EFFICIENCY



LS090HSV5
LS120HSV5
LS180HSV5



Specification	Unit	LS090HSV5	LS120HSV5	LS180HSV5	
Indoor Unit		LSN090HSV5	LSN120HSV5	LSN180HSV5	
Outdoor Unit		LSU090HSV5	LSU120HSV5	LSU180HSV5	
Capacity ^{1,2}	Rated Cooling Capacity	Btu/h	9,000	12,000	18,000
	Cooling Capacity Range	Btu/h	1,023 - 12,625	1,023 - 13,785	3,070 - 29,515
	Rated Heating Capacity	Btu/h	10,900	13,600	21,600
	Heating Capacity Range	Btu/h	1,023 - 17,061	1,023 - 22,178	3,070 - 38,898
	Max Heating Capacity at 17°F	Btu/h	11,080	13,810	22,340
	Max Heating Capacity at 5°F	Btu/h	9,570	11,930	19,300
	Max Heating Capacity at -4°F	Btu/h	8,310	10,360	16,760
	SEER, EER	Btu/h	23.5, 14.52	22.7, 12.5	21.5, 12.58
Power	HSPF		11.3	11.4	10.2
	Voltage (IDU)	V-Ø - Hz	208/230-1-60	208/230-1-60	208/230-1-60
	Voltage (ODU)	V-Ø - Hz	208/230-1-60	208/230-1-60	208/230-1-60
	Cooling Power Input	kW	0.62	0.96	1.43
	Heating Power Input	kW	0.71	1.04	1.73
	MCA, MOCP	A	10, 15	10, 15	13, 20
	Power/Communication Wiring ³	No. x AWG	4 x 14	4 x 14	4 x 14
Operation Range	Rated Amps (Cool/Heat)	A	7.4/7.4	7.4/7.4	9.85/9.85
	Heating Operation Range	°F WB	-4 - 65	-4 - 65	-4 - 65
	Cooling Operation Range	°F DB	14 - 118	14 - 118	14 - 118
	Optional Wind Baffle ⁴		ZLABGP01A (0°F)	ZLABGP01A (0°F)	ZLABGP02A (0°F)
	IDU Operation Range Cooling	°F	53 - 75	53 - 75	53 - 75
	IDU Operation Range Heating	°F	60 - 86	60 - 86	60 - 86
	Setpoint Range Cooling	°F	64 - 86	64 - 86	64 - 86
Dimensions	Setpoint Range Heating	°F	60 - 86	60 - 86	60 - 86
	IDU Dimensions (WxHxD)	in	32-15/16 x 12-1/8 x 7-7/16	32-15/16 x 12-1/8 x 7-7/16	39-9/32 x 13-19/32 x 8-9/32
	ODU Dimensions (WxHxD)	in	30-5/16 x 21-1/2 x 11-5/16	30-5/16 x 21-1/2 x 11-5/16	34-1/4 x 31-1/2 x 12-19/32
Weight	IDU Weight (Net/Shipping)	lbs	18.3 / 23.4	18.3 / 23.4	25.6 / 32.2
	ODU Weight (Net/Shipping)	lbs	74.1 / 78.9	74.1 / 78.9	116.8 / 126.5
Unit Data	Airflow (Max/H/M/L) ⁵	CFM	459 / 338 / 317 / 194	459 / 338 / 317 / 194	706 / 530 / 477 / 371
	Dehumidification	pts/hr	2.7	2.7	5.5
	Compressor Type		Twin Rotary	Twin Rotary	Twin Rotary
	Refrigerant Type		R410A	R410A	R410A
Sound Pressure ⁶	Indoor (H/M/L/SL)	dB(A)	39 / 33 / 23 / 19	39 / 33 / 23 / 19	45 / 40 / 35 / 29
	Outdoor Max	dB(A)	48	48	53
Piping ⁷	Liquid Pipe	in	1/4	1/4	3/8
	Vapor Pipe	in	3/8	3/8	5/8
	Pipe Length (Min/Max)	ft	9.8 / 82	9.8 / 82	9.8 / 114.8
	Max Pipe Elevation	ft	49.2	49.2	49.2
	Precharge Pipe Length	ft	41	41	24.6
	Additional Refrigerant	oz/ft	0.22	0.22	0.38
	Drain (OD, ID)	in	27/32, 5/8	27/32, 5/8	27/32, 5/8
Controller	Supplied		AKB74955602	AKB74955602	AKB74955602

Note:

- Rated capacity at 0 ft. above sea level with 25 ft. of refrigerant line and a 0 ft. level difference between outdoor and indoor unit.
- Rated cooling capacity obtained with air entering the indoor unit at 80°F dry bulb (DB) and 67°F wet bulb (WB) and outdoor ambient conditions of 95°F dry bulb (DB) and 75°F wet bulb (WB). Rated heating capacity obtained with air entering the indoor unit at 70°F dry bulb (DB) and 60°F wet bulb (WB) and outdoor ambient conditions of 47°F dry bulb (DB) and 43°F wet bulb (WB). For capacity information, see engineering manual capacity tables.
- All power/communication wiring minimum 4-conductor, stranded, shielded, and must comply with applicable local and national codes.
- Installation of an optional Low Ambient Wind Baffle Kit will allow operation down to 0°F in cooling mode for applicable outdoor units.
- Airflow shown is in cooling mode.
- Sound pressure levels are tested in an anechoic chamber under ISO Standard 3745 and are the same in both cooling and heating mode. These values can increase due to ambient conditions during operation.
- Piping lengths are equivalent.
- Due to our commitment to continued innovation, some specifications may be changed without notification.

MEGA



LS090HEV2
LS090HXV2
LS120HEV2
LS120HXV2
LS180HEV2
LS240HEV2



Specification	Unit	LS090HEV2	LS090HXV2	LS120HEV2	LS120HXV2	LS180HEV2	LS240HEV2
Indoor Unit		LSN090HEV2	LSN090HXV2	LSN120HEV2	LSN120HXV2	LSN180HEV2	LSN240HEV2
Outdoor Unit		LSU090HEV2	LSU090HXV2	LSU120HEV2	LSU120HXV2	LSU180HEV2	LSU240HEV2
Rated Cooling Capacity	Btu/h	9,000	9,000	12,000	12,000	18,000	22,000
Cooling Capacity Range	Btu/h	3,070 - 10,330	3,070 - 10,330	3,070 - 13,780	3,070 - 13,780	3,685 - 18,493	3,685 - 24,000
Rated Heating Capacity	Btu/h	10,900	10,900	12,000	12,000	19,000	22,000
Heating Capacity Range	Btu/h	3,070 - 12,520	3,070 - 12,520	3,070 - 13,780	3,070 - 13,780	3,685 - 22,997	3,685 - 25,260
Max Heating Capacity at 17°F	Btu/h	8,760	8,760	9,640	9,640	15,270	17,680
SEER, EER		20.0, 12.5	20.0, 12.3	19.0, 10.51	19.0, 10.5	19.0, 12.0	19.0, 11.0
HSPF		10.0	10.0	9.5	9.5	10.0	9.5
Power							
Voltage (IDU)	V, Ø, Hz	208/230-1-60	115-1-60	208/230-1-60	115-1-60	208/230-1-60	208/230-1-60
Voltage (ODU)	V, Ø, Hz	208/230-1-60	115-1-60	208/230-1-60	115-1-60	208/230-1-60	208/230-1-60
Cooling Power Input	kW	0.72	0.73	1.14	1.14	1.50	2.00
Heating Power Input	kW	0.88	0.88	1.00	1.00	1.58	1.93
MCA, MOCP	A	10, 15	15, 25	10, 15	15, 25	15, 20	15, 20
Power/Communication Wiring ³	No. x AWG	4 x 14	4 x 14	4 x 14	4 x 14	4 x 14	4 x 14
Rated Amps Cool/Heat	A	7.4/7.4	11.4/11.4	7.4/7.4	11.4/11.4	10.4/10.4	10.4/10.4
Operating Range							
Heating Operation Range	°F WB	14 - 65	14 - 65	14 - 65	14 - 65	14 - 65	14 - 65
Cooling Operation Range	°F DB	14 - 118	14 - 118	14 - 118	14 - 118	14 - 118	14 - 118
Optional Wind Baffle ⁴		No	No	No	No	No	No
IDU Operation Range Cooling	°F WB	53 - 75	53 - 75	53 - 75	53 - 75	53 - 75	53 - 75
IDU Operation Range Heating	°F DB	60 - 86	60 - 86	60 - 86	60 - 86	60 - 86	60 - 86
Setpoint Range Cooling	°F	64 - 86	64 - 86	64 - 86	64 - 86	64 - 86	64 - 86
Setpoint Range Heating	°F	60 - 86	60 - 86	60 - 86	60 - 86	60 - 86	60 - 86
Dimensions							
IDU Dimensions (WxHxD)	in	32-15/16x12-1/8x7-7/16	32-15/16x12-1/8x7-7/16	32-15/16x12-1/8x7-7/16	32-15/16x12-1/8x7-7/16	39-9/32x13-19/32x8-9/32	39-9/32x13-19/32x8-9/32
ODU Dimensions (WxHxD)	in	28-7/32x19-1/2x9-1/16	28-7/32x19-1/2x9-1/16	28-7/32x19-1/2x9-1/16	28-7/32x19-1/2x9-1/16	34-1/4x25-19/32x13	34-1/4x25-19/32x13
Weight							
IDU Weight (Net/Shipping)	lbs	19.2/25.4	19.2/22	19.2/25.4	19.2/22	26/30	26/30
ODU Weight (Net/Shipping)	lbs	55.3/60	58.4/60	55.3/60	58.4/60	98.1/108	98.1/108
Unit Data							
Airflow (Max/H/M/L)	CFM	459/353/264/148	459/353/264/148	459/353/264/148	459/353/264/148	689/512/459/371	689/512/459/371
Dehumidification	pts/hr	2.32	2.32	2.75	2.75	3.38	4.86
Compressor Type		Twin Rotary	Twin Rotary	Twin Rotary	Twin Rotary	Twin Rotary	Twin Rotary
Refrigerant Type		R410A	R410A	R410A	R410A	R410A	R410A
Sound Pressure ⁵							
Indoor (H/M/L/SL)	dB(A)	42/36/28/21	42/36/28/21	42/36/28/21	42/36/28/21	48/43/38/32	48/43/38/32
Outdoor Max	dB(A)	50	50	50	50	55	55
Piping ⁶							
Liquid Pipe	in	1/4	1/4	1/4	1/4	1/4	1/4
Vapor Pipe	in	3/8	3/8	3/8	3/8	1/2	1/2
Pipe Length (Min/Max)	ft	9.8/49.2	9.8/49.2	9.8/49.2	9.8/49.2	9.8/65.6	9.8/65.6
Max Pipe Elevation	ft	23.0	23.0	23.0	23.0	32.8	32.8
Precharge Pipe Length	ft	24.6	24.6	24.6	24.6	24.6	24.6
Additional Refrigerant	oz/ft	0.22	0.22	0.22	0.22	0.26	0.26
Drain (OD, ID)	in	27/32, 5/8	27/32, 5/8	27/32, 5/8	27/32, 5/8	27/32, 5/8	27/32, 5/8
Controller	Supplied	AKB74955602	AKB74955602	AKB74955602	AKB74955602	AKB74955602	AKB74955602

Note:

- Rated capacity at 0 ft. above sea level with 25 ft. of refrigerant line and a 0 ft. level difference between outdoor and indoor unit.
- Rated cooling capacity obtained with air entering the indoor unit at 80° F dry bulb (DB) and 67° F wet bulb (WB) and outdoor ambient conditions of 95° F dry bulb (DB) and 75° F wet bulb (WB). Rated heating capacity obtained with air entering the indoor unit at 70° F dry bulb (DB) and 60° F wet bulb (WB) and outdoor ambient conditions of 47° F dry bulb (DB) and 43° F wet bulb (WB). For capacity information, see engineering manual capacity tables.
- All power/communication wiring minimum 4-conductor, stranded, shielded, and must comply with applicable local and national codes.
- Airflow shown is in cooling mode.
- Sound pressure levels are tested in an anechoic chamber under ISO Standard 3745 and are the same in both cooling and heating mode. These values can increase due to ambient conditions during operation.
- Piping lengths are equivalent.
- Due to our commitment to continued innovation, some specifications may be changed without notification.

CEILING CASSETTE



LC098HV4
LC128HV4
LC188HV4

LC248HV
LC368HV
LC428HV



Specification	Unit	LC098HV4	LC128HV4	LC188HV4	LC248HV	LC368HV	LC428HV
Indoor Unit		LCN098HV4	LCN128HV4	LCN188HV4	LCN248HV	LCN368HV	LCN428HV
Outdoor Unit		LUU097HV	LUU127HV	LUU189HV	LUU249HV	LUU369HV	LUU429HV
Rated Cooling Capacity	Btu/h	9,000	11,100	18,000	24,000	36,000	42,000
Cooling Capacity Range	Btu/h	3,600 - 9,900	3,400 - 12,400	7,700 - 24,800	9,600 - 28,000	14,400 - 42,000	16,800 - 48,700
Rated Heating Capacity	Btu/h	11,000	14,000	18,500	27,000	40,000	47,000
Heating Capacity Range	Btu/h	4,400 - 12,100	2,800 - 15,500	6,500 - 23,400	10,800 - 30,000	16,000 - 42,200	18,800 - 49,800
Max Heating Capacity at 17°F	Btu/h	9,350	11,900	17,000	26,000	38,000	41,500
Max Heating Capacity at 5°F	Btu/h	8,250	10,500	15,000	23,600	35,000	40,000
SEER, EER		20.2, 13.65	19.4, 12.6	20.5, 12.5	20.0, 12.6	19.0, 12.5	17.8, 10.32
HSPF		10.5	10.4	10	10.5	9.5	9.0
Voltage (IDU)	V, Ø, Hz	208-230, 1, 60	208-230, 1, 60	208/230-1-60	208/230-1-60	208/230-1-60	208/230-1-60
Voltage (ODU)	V, Ø, Hz	208-230, 1, 60	208-230, 1, 60	208/230-1-60	208/230-1-60	208/230-1-60	208/230-1-60
Cooling Power Input	kW	0.66	0.88	1.44	1.90	2.88	4.07
Heating Power Input	kW	0.83	1.19	1.95	2.30	3.20	4.09
MCA, MOCP	A	11.9, 15	12.3, 15	20, 30	20, 30	32, 40	32, 40
Power/Communication Wiring ³	No. x AWG	4 x 14	4 x 14	4 x 14	4 x 14	4 x 14	4 x 14
Rated Amps Cool/Heat	A	9.65/9.65	10.05/10.05	15.1/15.1	15.7/15.7	26.3/26.3	26.3/26.3
Heating Operation Range	°F WB	-4 - 64	-4 - 64	-4 - 64	-4 - 64	-4 - 64	-4 - 64
Cooling Operation Range	°F DB	0 - 118	0 - 118	5 - 118	5 - 118	5 - 118	5 - 118
Optional Wind Baffle ⁴		ZLABGP01A (-4°F)	ZLABGP01A (-4°F)	ZLABGP04A (0°F)	ZLABGP04A (-4°F)	ZLABGP04A x 2 (-4°F)	ZLABGP04A x 2 (-4°F)
IDU Operation Range Cooling	°F WB	57 - 77	57 - 77	57 - 77	57 - 77	57 - 77	57 - 77
IDU Operation Range Heating	°F DB	59 - 81	59 - 81	59 - 81	59 - 81	59 - 81	59 - 81
Setpoint Range Cooling	°F	65 - 86	65 - 86	65 - 86	65 - 86	65 - 86	65 - 86
Setpoint Range Heating	°F	61 - 86	61 - 86	61 - 86	61 - 86	61 - 86	61 - 86
IDU Dimensions (WxHxD)	in	22-7/16 x 9-19/64 x 22-7/16	22-7/16 x 9-19/64 x 22-7/16	22-7/16 x 11 x 22-7/16	33-1/16 x 8-1/32 x 33-1/16	33-1/16 x 11-11/32 x 33-1/16	33-1/16 x 11-11/32 x 33-1/16
ODU Dimensions (WxHxD)	in	30-5/16 x 21-15/32 x 11-11/32	30-5/16 x 21-15/32 x 11-11/32	37-13/32 x 32-27/32 x 13	37-13/32 x 32-27/32 x 13	37-13/32 x 54-11/32 x 13	37-13/32 x 54-11/32 x 13
IDU Weight (Net/Shipping)	lbs	31/37	31/37	31.5 / 40.0	47.2 / 57.3	54.2 / 68.3	54.2 / 68.3
ODU Weight (Net/Shipping)	lbs	82/89	82/89	127.8 / 140.0	130 / 143.3	198.9 / 223.1	198.9 / 223.1
Airflow (H/M/L) ⁵	CFM	300/265/230	335/283/247	460/424/388	600/530/459	1,059/883/706	1,165/989/777
Dehumidification	pts/hr	1.60	2.47	3.3	4.5	7.6	10.1
Compressor Type		Twin Rotary	Twin Rotary	Twin Rotary	Twin Rotary	Scroll	Scroll
Refrigerant Type		R410A	R410A	R410A	R410A	R410A	R410A
Indoor (H/M/L)	dB(A)	36/33/30	38/35/32	41/39/36	38/36/34	46/43/40	47/44/41
Outdoor Max	dB(A)	51	52	52	52	54	54
Liquid Pipe	in	1/4	1/4	3/8	3/8	3/8	3/8
Vapor Pipe	in	3/8	3/8	5/8	5/8	5/8	5/8
Pipe Length (Min/Max)	ft	9.8/66	9.8/66	6.6/164	6.6/164	6.6/246	6.6/246
Max Pipe Elevation	ft	49.2	49.2	98.4	98.4	98.4	98.4
Precharge Pipe Length	ft	24.6	24.6	24.6	24.6	24.6	24.6
Additional Refrigerant	oz/ft	0.22	0.22	0.43	0.43	0.43	0.43
Drain (OD, ID)	in	1.25, 1	1.25, 1	1.25/1	1.25/1	1.25/1	1.25/1
Controller	Supplied	PQWRHQFDB	PQWRHQFDB	PQWRHQFDB	PQWRHQFDB	PQWRHQFDB	PQWRHQFDB
Grille		PT-QCHWO	PT-QCHWO	PT-QCHWO	PT-MCHWO	PT-MCHWO	PT-MCHWO
Grille Weight (Net/Shipping)	lbs	7/9	7/9	7/9	14/21	14/21	14/21

Note:

- Rated capacity at 0 ft. above sea level with 25 ft. of refrigerant line and a 0 ft. level difference between outdoor and indoor unit.
- Rated cooling capacity obtained with air entering the indoor unit at 80°F dry bulb (DB) and 67°F wet bulb (WB) and outdoor ambient conditions of 95°F dry bulb (DB) and 75°F wet bulb (WB).
Rated heating capacity obtained with air entering the indoor unit at 70°F dry bulb (DB) and 60°F wet bulb (WB) and outdoor ambient conditions of 47°F dry bulb (DB) and 43°F wet bulb (WB).
For capacity information, see engineering manual capacity tables.
- All power/communication wiring minimum 4-conductor, stranded, shielded, and must comply with applicable local and national codes.
- Installation of an optional Low Ambient Wind Baffle Kit will allow operation down to -4°F in cooling mode for applicable outdoor units.
- Airflow shown is in cooling mode.
- Sound pressure levels are tested in an anechoic chamber under ISO Standard 3745 and are the same in both cooling and heating mode. These values can increase due to ambient conditions during operation.
- Piping lengths are equivalent.
- Due to our commitment to continued innovation, some specifications may be changed without notification.

LOW STATIC DUCTED



LD097HV4
LD127HV4
LD187HV4



Specification	Unit	LD097HV4	LD127HV4	LD187HV4
Indoor Unit		LDN097HV4	LDN127HV4	LDN187HV4
Outdoor Unit		LUU097HV	LUU127HV	LUU189HV
Rated Cooling Capacity	Btu/h	9,000	11,600	18,000
Cooling Capacity Range	Btu/h	3,600 - 9,900	4,640 - 12,760	7,400 - 21,100
Rated Heating Capacity	Btu/h	14,000	16,000	20,000
Heating Capacity Range	Btu/h	5,600 - 15,400	6,400 - 17,600	6,800 - 21,800
Max Heating Capacity at 17°F	Btu/h	11,900	13,600	18,000
Max Heating Capacity at 5°F	Btu/h	10,500	12,000	16,000
SEER, EER		18.5, 12.7	19.6, 12.9	18, 11.5
HSPF		10.3	10.5	10
Voltage (IDU)	V, Ø, Hz	208-230, 1, 60	208-230, 1, 60	208-230, 1, 60
Voltage (ODU)	V, Ø, Hz	208-230, 1, 60	208-230, 1, 60	208-230, 1, 60
Cooling Power Input	kW	0.71	0.90	1.56
Heating Power Input	kW	1.43	1.29	2.0
MCA, MOCP	A	11.9, 15	12.3, 15	20, 30
Power/Communication Wiring ⁴	No. x AWG	4 x 14	4 x 14	4 x 14
Rated Amps Cool/Heat	A	9.65/9.65	10.05/10.05	15.9/15.9
Heating Operation Range	°F WB	-4 - 64	-4 - 64	-4 - 64
Cooling Operation Range	°F DB	0 - 118	0 - 118	5 - 118
Optional Wind Baffle ⁶		ZLABGP01A (-4°F)	ZLABGP01A (-4°F)	ZLABGP04A (-4°F)
IDU Operation Range Cooling	°F WB	57 - 77	57 - 77	57 - 77
IDU Operation Range Heating	°F DB	59 - 81	59 - 81	59 - 81
Setpoint Range Cooling	°F	65 - 86	65 - 86	65 - 86
Setpoint Range Heating	°F	61 - 86	61 - 86	61 - 86
IDU Dimensions (WxHxD)	in	27-9/16 x 7-15/32 x 27-9/16	35-7/16 x 7-15/32 x 27-9/16	35-7/16 x 7-15/32 x 27-9/16
ODU Dimensions (WxHxD)	in	30-5/16 x 21-15/32 x 11-11/32	30-5/16 x 21-15/32 x 11-11/32	37-13/32 x 32-27/32 x 13
IDU Weight (Net/Shipping)	lbs	39/46	51/60	49/58
ODU Weight (Net/Shipping)	lbs	82/89	82/89	128/140
Airflow (Max/H/M/L) ⁷	CFM	318 / 247 / 194	353 / 300 / 247	530 / 441 / 353
Dehumidification	pts/hr	1.50	2.28	2.4
Compressor Type		Twin Rotary	Twin Rotary	Twin Rotary
Refrigerant Type		R-410A	R-410A	R-410A
Max External Static Pressure	in wg	0.20	0.20	0.20
Indoor (H/M/L)	dB(A)	30 / 26 / 23	31 / 28 / 27	36 / 34 / 31
Outdoor Max	dB(A)	51	52	52
Liquid Pipe	in	1/4	1/4	3/8
Vapor Pipe	in	3/8	3/8	5/8
Pipe Length (Min/Max)	ft	9.8/66	9.8/66	6.6/164
Max Pipe Elevation	ft	49.2	49.2	98.4
Precharge Pipe Length	ft	24.6	24.6	24.6
Additional Refrigerant	oz/ft	0.22	0.22	0.43
Drain (OD, ID)	in	1.25/1	1.25/1	1.25/1
Controller	Additional Accessory ⁹	Wired Controller	Wired Controller	Wired Controller

Note:

- Rated capacity at 0 ft. above sea level with 25 ft. of refrigerant line and a 0 ft. level difference between outdoor and indoor unit.
- Rated cooling capacity obtained with air entering the indoor unit at 80°F dry bulb (DB) and 67°F wet bulb (WB) and outdoor ambient conditions of 95°F dry bulb (DB) and 75°F wet bulb (WB). Rated heating capacity obtained with air entering the indoor unit at 70°F dry bulb (DB) and 60°F wet bulb (WB) and outdoor ambient conditions of 47°F dry bulb (DB) and 43°F wet bulb (WB). For capacity information, see engineering manual capacity tables.
- Sound pressure levels are tested in an anechoic chamber under ISO Standard 3745 and are the same in both cooling and heating mode. These values can increase due to ambient conditions during operation.
- All power/communication wiring minimum 4-conductor, stranded, shielded, and must comply with applicable local and national codes.
- Piping lengths are equivalent.
- Installation of an optional Low Ambient Wind Baffle Kit will allow operation down to 0°F in cooling mode for applicable outdoor units.
- Airflow shown is in cooling mode.
- Due to our commitment to continued innovation, some specifications may be changed without notification.
- All LG wired controls are compatible and can be considered for control.

HIGH STATIC DUCTED



LH248HV4
LH368HV4



Specification	Unit	LH248HV4	LH368HV4
Indoor Unit		LHN248HV	LHN368HV
Outdoor Unit		LUU249HV	LUU369HV
Rated Cooling Capacity	Btu/h	24,000	36,000
Cooling Capacity Range	Btu/h	9,600 - 27,000	14,400 - 41,400
Rated Heating Capacity	Btu/h	27,000	40,000
Heating Capacity Range	Btu/h	10,800 - 30,000	16,000 - 42,200
Max Heating Capacity at 17°F	Btu/h	26,000	41,500
Max Heating Capacity at 5°F	Btu/h	23,600	35,000
SEER, EER		19.0, 12.0	19.0, 12.1
HSPF		10.5	9.7
Voltage (IDU)	V, Ø, Hz	208/230-1-60	208/230-1-60
Voltage (ODU)	V, Ø, Hz	208/230-1-60	208/230-1-60
Cooling Power Input	kW	2.98	2.98
Heating Power Input	kW	2.08	3.08
MCA, MOCP	A	20, 30	32, 40
Power/Communication Wiring ^d	No. x AWG	4 x 14	4 x 14
Rated Amps Cool/Heat	A	16.7/16.7	27.5/27.5
Heating Operation Range	°F WB	-4 - 64	-4 - 64
Cooling Operation Range	°F DB	5 - 118	5 - 118
Optional Wind Baffle ^e		ZLABGP04A (-4°F)	ZLABGP04A x 2 (-4°F)
IDU Operation Range Cooling	°F WB	57 - 77	57 - 77
IDU Operation Range Heating	°F DB	59 - 81	59 - 81
Setpoint Range Cooling	°F	65 - 86	65 - 86
Setpoint Range Heating	°F	61 - 86	61 - 86
IDU Dimensions (WxHxD)	in	35-1/2 x 10-11/16 x 27-1/4	49-9/32 x 10-11/16 x 27-1/4
ODU Dimensions (WxHxD)	in	37-13/32 x 32-27/32 x 13	37-19/32 x 54-11/32 x 13
IDU Weight (Net/Shipping)	lbs	58.6 / 71.9	85.3 / 99.4
ODU Weight (Net/Shipping)	lbs	130.0 / 143.3	198.9 / 223.1
Airflow (Max/H/M/L) ⁷	CFM	777/706/636	1,130/989/848
Dehumidification	pts/hr	5.1	5.9
Compressor Type		Twin Rotary x 1	Scroll x 1
Refrigerant Type		R410A	R410A
Max External Static Pressure	in wg	0.24	0.24
Indoor (H/M/L)	dB(A)	37 / 35 / 34	44 / 42 / 40
Outdoor Max (Cool / Heat)	dB(A)	48 / 52	52 / 54
Liquid Pipe	in	3/8	3/8
Vapor Pipe	in	5/8	5/8
Pipe Length (Min/Max)	ft	24.6/164	24.6/246.1
Max Pipe Elevation	ft	98.4	98.4
Precharge Pipe Length	ft	24.6	24.6
Additional Refrigerant	oz/ft	0.43	0.43
Drain (OD, ID)	in	1.25/1	1.25/1
Controller	Additional Accessory ⁹	Wired Controller	Wired Controller

Note:

- Rated capacity at 0 ft. above sea level with 25 ft. of refrigerant line and a 0 ft. level difference between outdoor and indoor unit.
- Rated cooling capacity obtained with air entering the indoor unit at 80°F dry bulb (DB) and 67°F wet bulb (WB) and outdoor ambient conditions of 95°F dry bulb (DB) and 75°F wet bulb (WB). Rated heating capacity obtained with air entering the indoor unit at 70°F dry bulb (DB) and 60°F wet bulb (WB) and outdoor ambient conditions of 47°F dry bulb (DB) and 43°F wet bulb (WB). For capacity information, see engineering manual capacity tables.
- Sound pressure levels are tested in an anechoic chamber under ISO Standard 3745 and are the same in both cooling and heating mode. These values can increase due to ambient conditions during operation.
- All power/communication wiring minimum 4-conductor, stranded, shielded, and must comply with applicable local and national codes.
- Piping lengths are equivalent.
- Installation of an optional Low Ambient Wind Baffle Kit will allow operation down to 0°F in cooling mode for applicable outdoor units.
- Airflow shown is in cooling mode.
- Due to our commitment to continued innovation, some specifications may be changed without notification.
- All LG wired controls are compatible and can be considered for control.

VERTICAL AHU



LV181HV4
LV241HV4



LV361HV4
LV420HV
LV480HV





















Specification	Unit	LV181HV4	LV241HV4	LV361HV4	LV420HV	LV480HV
Indoor Unit		LVN181HV4	LVN241HV4	LVN361HV4	LVN420HV	LVN480HV
Outdoor Unit		LUU189HV	LUU249HV	LUU369HV	LUU428HV	LUU488HV
Rated Cooling Capacity	Btu/h	18,000	24,000	36,000	42,000	48,000
Cooling Capacity Range	Btu/h	7,200 - 24,000	9,600 - 30,000	14,400 - 39,000	17,000 - 48,000	18,000 - 53,000
Rated Heating Capacity	Btu/h	20,000	27,000	40,000	47,000	56,000
Heating Capacity Range	Btu/h	8,000 - 24,000	10,800 - 30,000	16,000 - 43,000	18,000 - 55,000	19,000 - 60,000
Capacity ^{1,2}						
Max Heating Capacity at 17°F	Btu/h	21,000	26,000	37,350	37,000	40,000
Max Heating Capacity at 5°F	Btu/h	20,500	23,600	35,000	32,000	34,000
Max Heating Capacity at -4°F	Btu/h	19,910	20,760	32,220	24,000	26,000
SEER, EER		19.2, 13.30	19.5, 12.0	18, 11	17, 11.05	16.5, 10
HSPF		10.4	11	10	10	9.5
Power						
Voltage (IDU)	V, Ø, Hz	208/230-1-60	208/230-1-60	208/230-1-60	208/230-1-60	208/230-1-60
Voltage (ODU)	V, Ø, Hz	208/230-1-60	208/230-1-60	208/230-1-60	208/230-1-60	208/230-1-60
Cooling Power Input	kW	1.35	2.00	3.27	3.80	4.80
Heating Power Input	kW	1.73	2.25	3.57	4.00	5.10
MCA, MOCP	A	20, 30	20, 30	32, 40	32, 40	32, 40
Power/Communication Wiring ³	No. x AWG	4 x 14	4 x 14	4 x 14	4 x 14	4 x 14
Rated Amps Cool	A	16.2	16.2	26.3	24.2	24.2
Operating Range						
Heating Operation Range	°F WB	-4 - 64	-4 - 64	-4 - 64	-4 - 64	-4 - 64
Cooling Operation Range	°F DB	5 - 118	5 - 118	5 - 118	5 - 118	5 - 118
Optional Wind Baffle ⁴		ZLABGP04A (-4°F)	ZLABGP04A (-4°F)	ZLABGP04A x 2 (-4°F)	ZLABGP04A x 2 (-4°F)	ZLABGP04A x 2 (-4°F)
IDU Operation Range Cooling	°F WB	57-77	57-77	57-77	57-77	57-77
IDU Operation Range Heating	°F DB	59-81	59-81	59-81	59-81	59-81
Setpoint Range Cooling	°F	65-86	65-86	65-86	65-86	65-86
Setpoint Range Heating	°F	61-86	61-86	61-86	61-86	61-86
Dimensions						
IDU Dimensions (WxHxD)	in	18 x 48-11/16 x 21-1/4	18 x 48-11/16 x 21-1/4	18 x 48-11/16 x 21-1/4	25 x 55-3/16 x 21-1/4	25 x 55-3/16 x 21-1/4
ODU Dimensions (WxHxD)	in	37-13/32 x 32-27/32 x 13	37-13/32 x 32-27/32 x 13	37-13/32 x 54-11/32 x 13	37-13/32 x 54-11/32 x 13	37-13/32 x 54-11/32 x 13
Weight						
IDU Weight (Net/Shipping)	lbs	123.5 / 135.1	123.5 / 135.1	129 / 140	165 / 188	165 / 188
ODU Weight (Net/Shipping)	lbs	129 / 141	130.0 / 143.3	198.9 / 223.1	203 / 232	203 / 232
Unit Data						
Airflow (Max/H/M/L) ⁵	CFM	640 / 580 / 480	710 / 640 / 480	980 / 880 / 800	1,260 / 1,100 / 1,000	1,400 / 1,260 / 1,000
Dehumidification	pts/hr	3.1	4.0	5.1	4.3	5.2
Compressor Type		Twin Rotary	Twin Rotary	Scroll	Twin Rotary	Twin Rotary
Fan Motor Type		Constant CFM ECM	Constant CFM ECM	Constant CFM ECM	BLDC	BLDC
Refrigerant Type		R410A	R410A	R410A	R410A	R410A
Sound Pressure ⁶						
Indoor (H/M/L/SL)	dB(A)	35 / 33 / 30	36 / 34 / 30	44 / 41 / 39	48 / 45 / 44	49 / 48 / 44
Outdoor Max (Cool / Heat)	dB(A)	48 / 52	48 / 52	52 / 54	52 / 54	52 / 54
Piping ⁷						
Liquid Pipe	in	3/8	3/8	3/8	3/8	3/8
Vapor Pipe	in	5/8	5/8	5/8	5/8	5/8
Pipe Length (Min/Max)	ft	6.6 / 164	6.6 / 164	6.6 / 246	6.6 / 246	6.6 / 246
Max Pipe Elevation	ft	98.4	98.4	98.4	98.4	98.4
Precharge Pipe Length	ft	24.6	24.6	24.6	24.6	24.6
Additional Refrigerant	oz/ft	0.43	0.43	0.43	0.43	0.43
Drain (OD, ID)	in	Primary & Secondary: 3/4 FPT	Primary & Secondary: 3/4 FPT	Primary & Secondary: 3/4 FPT	Primary & Secondary: 3/4 FPT	Primary & Secondary: 3/4 FPT
Controller	Additional Accessory ⁹	Wired Controller	Wired Controller	Wired Controller	Wired Controller	Wired Controller

Note:

- Rated capacity at 0 ft. above sea level with 25 ft. of refrigerant line and a 0 ft. level difference between outdoor and indoor unit.
- Rated cooling capacity obtained with air entering the indoor unit at 80°F dry bulb (DB) and 67°F wet bulb (WB) and outdoor ambient conditions of 95°F dry bulb (DB) and 75°F wet bulb (WB). Rated heating capacity obtained with air entering the indoor unit at 70°F dry bulb (DB) and 60°F wet bulb (WB) and outdoor ambient conditions of 47°F dry bulb (DB) and 43°F wet bulb (WB). For capacity information, see engineering manual capacity tables.
- All power/communication wiring minimum 4-conductor, stranded, shielded, and must comply with applicable local and national codes.
- Installation of an optional Low Ambient Wind Baffle Kit will allow operation down to -4°F in cooling mode for applicable outdoor units.
- Airflow shown is in cooling mode.
- Sound pressure levels are tested in an anechoic chamber under ISO Standard 3745 and are the same in both cooling and heating mode. These values can increase due to ambient conditions during operation.
- Piping lengths are equivalent.
- Due to our commitment to continued innovation, some specifications may be changed without notification.
- All LG wired controls are compatible and can be considered for control.























MULTI-ZONE

Lineup

OUTDOOR UNITS				
Btu/h	Multi F	Maximum Indoor Units	Combination Sample	
18,000	 LMU18CHV   LMU180HHV	2		
24,000	 LMU24CHV   LMU240HHV	3		
30,000	 LMU30CHV   LMU300HHV	4		
36,000	 LMU36CHV	4		
kBtu	Multi F MAX	Maximum Indoor Units		Combination Sample
36,000	 LMU360HHV 	5		
42,000	 LMU420HHV 	6		
48,000	 LMU480HV	8		
54,000	 LMU540HV	8		
60,000	 LMU600HV	8		

MULTI-ZONE

Lineup

INDOOR UNITS							
Btu/h	7,000	9,000	12,000	15,000	18,000	24,000	36,000
Wall Mounted	ART COOL™ Gallery		 LMAN097HVP	 LMAN127HVP			
	ART COOL™ Mirror		 LAN090HSV5	 LAN120HSV5		 LAN180HSV5	
	High Efficiency	 LMN079HVT	 LSN090HSV5	 LSN120HSV5	 LMN159HVT	 LSN180HSV5	 LMN249HVT
Ceiling Cassette	4-Way	 LMCN078HV	 LCN098HV4	 LCN128HV4		 LCN188HV4	
Ducted	Low Static		 LDN097HV4	 LDN127HV4		 LDN187HV4	
	High Static					 LHN248HV	 LHN368HV
	Vertical AHU					 LVN181HV4	 LVN241HV4

MULTI F OUTDOOR UNITS

LMU18CHV
LMU24CHV



LMU30CHV
LMU36CHV



Specification	Unit	LMU18CHV	LMU24CHV	LMU30CHV	LMU36CHV	
Capacity	Rated Cooling Capacity	Btu/h	17,000	20,000	30,000	32,000
	Cooling Capacity Range	Btu/h	8,400 - 19,000	8,400 - 25,000	8,400 - 36,000	8,400 - 38,400
	Rated Heating Capacity	Btu/h	22,000	24,000	32,000	36,000
	Heating Capacity Range	Btu/h	10,248 - 24,000	9,240 - 28,800	9,240 - 38,400	9,240 - 41,600
	Max Heating Capacity at 17° F	Btu/h	19,161	21,097	26,739	29,105
	Max Heating Capacity at 5° F	Btu/h	14,807	14,595	20,622	22,057
	Max Heating Capacity at -4° F	Btu/h	9,912	10,385	13,753	15,823
Power	SEER, EER		22.0, 13.0	21.7, 13.5	22.0, 13.0	22.0, 13.0
	HSPF		9.7	10.6	10.0	10.0
	Voltage	V, Ø, Hz	208/230-1-60	208/230-1-60	208/230-1-60	208/230-1-60
	Cooling Power Input	kW	1.31	1.48	2.31	2.46
	Heating Power Input	kW	2.04	1.80	2.49	2.74
	MCA, MOCP	A	13.3, 20	14.3, 20	16.6, 25.0	17.9, 25
	Rated Amps (Cool/Heat)	A	11.09/11.09	11.99/11.99	13.93/13.93	15.13/15.13
Operating Range	Power/Communication Wiring ⁴	No. x AWG	4 x 14	4 x 14	4 x 14	4 x 14
	Heating Operation Range	°F WB	-4 - 64	-4 - 64	-4 - 64	-4 - 64
	Cooling Operation Range	°F DB	14 - 118	14 - 118	14 - 118	14 - 118
Dimensions & Weight	Optional Wind Baffle ⁷		ZLABGP03A (-4° F)	ZLABGP03A (-4° F)	ZLABGP04A (-4° F)	ZLABGP04A (-4° F)
	Dimensions (WxHxD)	in	34-1/4x25-25/32x12-19/32	34-1/4x25-25/32x12-19/32	37-13/32 x 32-27/32 x 13	37-13/32 x 32-27/32 x 13
	Weight (Net/Shipping)	lbs	100/108	100/108	137/148	137/148
Unit Data	Refrigerant Type		R410A	R410A	R410A	R410A
	Compressor Type		Twin Rotary	Twin Rotary	Twin Rotary	Twin Rotary
	Sound Pressure (Cooling / Heating)	dB(A)	49/52	49/52	52/55	52/55
	Maximum Air Volume	CFM	1,766	1,766	2,119	2,119
	Minimum Connectable IDUs	Qty	2	2	2	2
	Maximum Connectable IDUs	Qty	2	3	4	4
	Max Total IDU Connected Capacity	Btu/h	24,000	33,000	40,000	48,000
Piping	Liquid Pipe	in	1/4 x 2	1/4 x 3	1/4 x 4	1/4 x 4
	Vapor Pipe	in	3/8 x 2	3/8 x 3	3/8 x 4	3/8 x 4
	Maximum Total Pipe Length	ft	164	246.1	246.1	246.1
	Minimum Pipe Length per Segment	ft	9.8	9.8	9.8	9.8
	Maximum Pipe Length ODU to IDU	ft	82	82	82	82
	Precharge Pipe Length	ft	49.2	73.8	98.4	98.4
	Maximum Elevation ODU to IDU	ft	49.2	49.2	49.2	49.2
	Maximum Elevation IDU to IDU	ft	24.6	24.6	24.6	24.6
	Factory Charge of R410A	lbs	3.96	3.96	6.18	6.18
	Additional Refrigerant	oz/ft	0.22	0.22	0.22	0.22

Note:

- Rated capacity at 0 ft. above sea level with 25 ft. of refrigerant line and a 0 ft. level difference between outdoor and indoor unit.
- Rated cooling capacity obtained with air entering the indoor unit at 80° F dry bulb (DB) and 67° F wet bulb (WB) and outdoor ambient conditions of 95° F dry bulb (DB) and 75° F wet bulb (WB).
Rated heating capacity obtained with air entering the indoor unit at 70° F dry bulb (DB) and 60° F wet bulb (WB) and outdoor ambient conditions of 47° F dry bulb (DB) and 43° F wet bulb (WB).
For capacity information, see engineering manual capacity tables. Capacities are based on connection of Non-Ducted indoor units.
- Sound pressure levels are tested in an anechoic chamber under ISO Standard 3745 and are the same in both cooling and heating mode. These values can increase due to ambient conditions during operation.
- All power/communication wiring minimum 4-conductor, stranded, shielded, and must comply with applicable local and national codes.
- Values when matched with non-ducted units only.
- Piping lengths are equivalent.
- Installation of an optional Low Ambient Wind Baffle Kit will allow operation down to -4° F in cooling mode for applicable outdoor units.
- Due to our commitment to continued innovation, some specifications may be changed without notification.

MULTI F OUTDOOR UNITS with LGRED°



LMU180HHV
LMU240HHV

LGRED°



LMU300HHV

LGRED°

Multi-Zone

• OUTDOOR UNITS

Model	Specification	Unit	LMU180HHV	LMU240HHV	LMU300HHV
Capacity ^{1,2}	Rated Cooling Capacity	Btu/h	18,000	24,000	28,400
	Cooling Capacity Range	Btu/h	8,400 - 19,980	8,400 - 30,000	8,400 - 34,080
	Rated Heating Capacity	Btu/h	22,000	26,000	28,600
	Heating Capacity Range	Btu/h	10,248 - 24,000	10,248 - 31,200	10,248 - 34,320
	Max Heating Capacity at 17°F	Btu/h	23,600	28,500	31,600
	Max Heating Capacity at 5°F	Btu/h	22,000	26,000	28,600
	Max Heating Capacity at -4°F	Btu/h	21,050	23,880	25,550
	Max Heating Capacity at -13°F	Btu/h	19,270	21,310	22,210
SEER, EER ³			21, 13.5	21, 13.5	20, 12.5
HSPF ³			10	10.7	11
Power	Voltage	V- Ø - Hz	208/230-1-60	208/230-1-60	208/230-1-60
	Cooling Power Input	kW	1.33	1.78	2.27
	Heating Power Input	kW	2.22	2.12	2.33
	MCA, MOCP ⁴	A	18.6, 30	19, 30	19.4, 30
	Rated Amps	A	15.33	15.73	16.13
	Power/Communication Wiring ⁵	No. x AWG	4 x 14	4 x 14	4 x 14
	Heating Operation Range	°F WB	-13 - 64	-13 - 64	-13 - 64
Operating Range	Cooling Operation Range	°F DB	14 - 118	14 - 118	14 - 118
	Optional Wind Baffle ⁶		ZLABGP04A (-4°F)	ZLABGP04A (-4°F)	ZLABGP04A (-4°F)
Dimensions & Weight	Dimensions (WxHxD)	in	37-13/32 x 32-27/32 x 13	37-13/32 x 32-27/32 x 13	37-13/32 x 32-27/32 x 13
	Weight (Net/Shipping)	lbs	147.7/163.1	152.1/165.3	152.1/165.3
Unit Data	Refrigerant Type		R410A	R410A	R410A
	Compressor Type		Twin Rotary	Twin Rotary	Twin Rotary
	Sound Pressure (Cooling / Heating) ⁷	dB(A)	50, 54	52, 55	52, 55
	Maximum Air Volume	CFM	2,295	2,295	2,295
	Minimum Connectable IDUs	Qty	2	2	2
	Maximum Connectable IDUs	Qty	2	3	4
	Max Total IDU Connected Capacity	Btu/h	24,000	33,000	40,000
	Liquid Pipe	in	1/4 x 2	1/4 x 3	1/4 x 4
Piping	Vapor Pipe	in	3/8 x 2	3/8 x 3	3/8 x 4
	Maximum Total Pipe Length	ft	164	246.1	246.1
	Minimum Pipe Length per Segment	ft	9.8	9.8	9.8
	Maximum Pipe Length ODU TO IDU	ft	82	82	82
	Precharge Pipe Length	ft	49.2	73.8	98.4
	Maximum Elevation ODU to IDU	ft	49.2	49.2	49.2
	Maximum Elevation IDU to IDU	ft	24.6	24.6	24.6
	Factory Charge of R410A	lbs	6.18	7.05	7.05
Additional Refrigerant	oz/ft	0.22	0.22	0.22	

Note:

- Rated capacity at 0 ft. above sea level with 25 ft. of refrigerant line and a 0 ft. level difference between outdoor and indoor unit.
- Rated cooling capacity obtained with air entering the indoor unit at 80°F dry bulb (DB) and 67°F wet bulb (WB) and outdoor ambient conditions of 95°F dry bulb (DB) and 75°F wet bulb (WB). Rated heating capacity obtained with air entering the indoor unit at 70°F dry bulb (DB) and 60°F wet bulb (WB) and outdoor ambient conditions of 47°F dry bulb (DB) and 43°F wet bulb (WB). For capacity information, see engineering manual capacity tables. Capacities are based on connection of Non-Ducted indoor units.
- Values when matched with non-ducted units only.
- Recommended fuse size is 25 Amps.
- All power/communication wiring minimum 4-conductor, stranded, shielded, and must comply with applicable local and national codes.
- Installation of an optional Low Ambient Wind Baffle Kit will allow operation down to -4°F in cooling mode for applicable outdoor units.
- Sound pressure levels are tested in an anechoic chamber under ISO Standard 3745 and are the same in both cooling and heating mode. These values can increase due to ambient conditions during operation.
- Piping lengths are equivalent.
- Due to our commitment to continued innovation, some specifications may be changed without notification.

MULTI F MAX OUTDOOR UNITS



LMU480HV
LMU540HV
LMU600HV

Specification	Unit	LMU480HV	LMU540HV	LMU600HV	
Capacity	Rated Cooling Capacity	Btu/h	48,000	52,500	60,000
	Cooling Capacity Range	Btu/h	14,400 - 58,000	14,400 - 63,200	15,600 - 68,000
	Rated Heating Capacity	Btu/h	54,000	58,000	64,000
	Heating Capacity Range	Btu/h	15,840 - 61,000	16,272 - 64,000	17,940 - 70,000
	Max Heating Capacity at 17°F	Btu/h	49,014	51,832	53,560
	Max Heating Capacity at 5°F	Btu/h	38,900	41,137	42,720
	Max Heating Capacity at -4°F	Btu/h	27,529	29,112	33,193
	SEER, EER ⁵		19.5, 12.5	18.4, 10.3	20.5, 11.4
HSPF ⁵		10.0	8.7	11	
Power	Voltage	V, Ø, Hz	208/230-1-60	208/230-1-60	208/230-1-60
	Cooling Power Input	kW	3.84	5.1	5.26
	Heating Power Input	kW	4.32	5.4	5.33
	MCA, MOCP	A	27.3, 40	29.4, 40	32.2, 45
	Rated Amps (Cool/Heat)	A	22.96/22.96	24.76/24.76	27.06/27.06
	Power/Communication Wiring ⁶	No. x AWG	ODU → BDU: 4 x 14 BDU → IDU: 4 x 14	ODU → BDU: 4 x 14 BDU → IDU: 4 x 14	ODU → BDU: 4 x 14 BDU → IDU: 4 x 14
Operating Range	Heating Operation Range	°F WB	-4 - 64	-4 - 64	-4 - 64
	Cooling Operation Range	°F DB	14 - 118	14 - 118	14 - 118
	Optional Wind Baffle ⁷		ZLABGP04A x 2 (-4°F)	ZLABGP04A x 2 (-4°F)	ZLABGP04A x 2 (-4°F)
Dimensions & Weight	Dimensions (WxHxD)	in	37-13/32 x 54-11/32 x 13	37-13/32 x 54-11/32 x 13	37-13/32x54-11/32x13
	Weight (Net/Shipping)	lbs	214/236	214/236	223/249
Unit Data	Refrigerant Type		R410A	R410A	R-410A
	Compressor Type		Twin Rotary	Twin Rotary	Twin Rotary
	Sound Pressure (Cooling / Heating)	dB(A)	54/56	54/56	56/58
	Maximum Air Volume	CFM	2,119 x 2	2,119 x 2	2,119 x 2
	Minimum Connectable IDUs	Qty	2	2	2
	Maximum Connectable IDUs	Qty	8	8	8
	Max Total IDU Connected Capacity	Btu/h	65,000	73,000	81,000
Piping	Liquid Pipe	in	3/8	3/8	3/8
	Vapor Pipe	in	3/4	3/4	3/4
	Maximum Total Pipe Length	ft	475.7	475.7	475.7
	Minimum Pipe Length per Segment	ft	9.8	9.8	9.80
	Maximum Pipe Length ODU to IDU	ft	229.6	229.6	229.6
	Maximum Main Pipe Length	ft	180.4	180.4	180.4
	Precharge Pipe Length	ft	Main: 16.4 Branch: 131.2	Main: 16.4 Branch: 131.2	Main: 16.4 Branch: 131.2
	Maximum Elevation ODU to IDU	ft	98.4	98.4	98.4
	Maximum Elevation IDU to IDU	ft	49.2	49.2	49.2
	Maximum Elevation BDU to IDU	ft	32.8	32.8	38.2
	Maximum Elevation BDU to BDU	ft	49.2	49.2	49.2
	Factory Charge of R410A	lbs	9.7	9.7	12.3
	Additional Refrigerant	oz/ft	Main: 0.54 Branch: 0.22	Main: 0.54 Branch: 0.22	Main: 0.54 Branch: 0.22

Note:

- Rated capacity at 0 ft. above sea level with 25 ft. of refrigerant line and a 0 ft. level difference between outdoor and indoor unit.
- Rated cooling capacity obtained with air entering the indoor unit at 80°F dry bulb (DB) and 67°F wet bulb (WB) and outdoor ambient conditions of 95°F dry bulb (DB) and 75°F wet bulb (WB).
Rated heating capacity obtained with air entering the indoor unit at 70°F dry bulb (DB) and 60°F wet bulb (WB) and outdoor ambient conditions of 47°F dry bulb (DB) and 43°F wet bulb (WB).
For capacity information, see engineering manual capacity tables. Capacities are based on connection of Non-Ducted indoor units.
- Sound pressure levels are tested in an anechoic chamber under ISO Standard 3745 and are the same in both cooling and heating mode. These values can increase due to ambient conditions during operation.
- All power/communication wiring minimum 4-conductor, stranded, shielded, and must comply with applicable local and national codes.
- Values when matched with non-ducted units only.
- Piping lengths are equivalent.
- Installation of an optional Low Ambient Wind Baffle Kit will allow operation down to -4°F in cooling mode for applicable outdoor units.
- Due to our commitment to continued innovation, some specifications may be changed without notification.

MULTI F MAX OUTDOOR UNITS with LGRED°



LMU360HHV
LMU420HHV

LGRED°

Multi-Zone

OUTDOOR UNITS

Specification	Unit	LMU360HHV	LMU420HHV	
Capacity	Rated Cooling Capacity	Btu/h	36,000	42,000
	Cooling Capacity Range	Btu/h	11,700 - 46,733	11,700 - 53,897
	Rated Heating Capacity	Btu/h	41,000	45,000
	Heating Capacity Range	Btu/h	13,455 - 50,200	13,455 - 55,256
	Max Heating Capacity at 17°F	Btu/h	45,510	49,950
	Max Heating Capacity at 5°F	Btu/h	41,000	45,000
	Max Heating Capacity at -4°F	Btu/h	36,900	39,150
	Max Heating Capacity at -13°F	Btu/h	32,390	34,200
	SEER, EER ³		21, 15	20.5, 14
HSPF ³		11.5	11	
Power	Voltage	V- Ø - Hz	208/230-1-60	208/230-1-60
	Cooling Power Input	kW	2.4	3
	Heating Power Input	kW	2.93	3.3
	MCA, MOCP ⁴	A	30.2, 45	30.2, 45
	Rated Amps	A	25.06	25.06
	Power/Communication Wiring ⁵	A	ODU --> BDU: 4 x 14 BDU --> IDU: 4 x 14	ODU --> BDU: 4 x 14 BDU --> IDU: 4 x 14
	Operating Range	Heating Operation Range	°F WB	-13 - 64
Cooling Operation Range		°F DB	14 - 118	14 - 118
Optional Wind Baffle ⁶			ZLABGP04A x2 (-4°F)	ZLABGP04A x2 (-4°F)
Dimensions & Weight	Dimensions (WxHxD)	in	37-13/32 x 54-11/32 x 13	37-13/32 x 54-11/32 x 13
	Weight (Net/Shipping)	lbs	222.7/249.1	222.7/249.1
Unit Data	Refrigerant Type		R410A	R410A
	Compressor Type		Twin Rotary	Twin Rotary
	Sound Pressure (Cooling / Heating) ⁷	dB(A)	54 / 57	54 / 57
	Maximum Air Volume	CFM	2,119 x 2	2,119 x 2
	Minimum Connectable IDUs	Qty	2	2
	Maximum Connectable IDUs	Qty	5	6
	Max Total IDU Connected Capacity	Btu/h	48,000	56,000
	Piping	Liquid Pipe	in	3/8
Vapor Pipe		in	3/4	3/4
Maximum Total Pipe Length		ft	475.7	475.7
Minimum Pipe Length per Segment		ft	9.8	9.8
Maximum Pipe Length ODU to IDU		ft	229.6	229.6
Maximum Main Pipe Length (ODU to BDU)		ft	180.4	180.4
Maximum Branch Piping		ft	295.3	295.3
Maximum Pipe Length BDU to IDU		ft	49.2	49.2
Precharge Pipe Length		ft	Main: 16.4 Branch: 131.2	Main: 16.4 Branch: 131.2
Maximum Elevation ODU to IDU		ft	98.4	98.4
Maximum Elevation IDU to IDU		ft	49.2	49.2
Maximum Elevation BDU to IDU		ft	32.8	32.8
Maximum Elevation BDU to BDU		ft	49.2	49.2
Factory Charge of R410A		lbs	12.3	12.3
Additional Refrigerant	oz/ft	Main: 0.54 Branch: 0.22	Main: 0.54 Branch: 0.22	

Note:

- Rated capacity at 0 ft. above sea level with 25 ft. of refrigerant line and a 0 ft. level difference between outdoor and indoor unit.
- Rated cooling capacity obtained with air entering the indoor unit at 80°F dry bulb (DB) and 67°F wet bulb (WB) and outdoor ambient conditions of 95°F dry bulb (DB) and 75°F wet bulb (WB). Rated heating capacity obtained with air entering the indoor unit at 70°F dry bulb (DB) and 60°F wet bulb (WB) and outdoor ambient conditions of 47°F dry bulb (DB) and 43°F wet bulb (WB). For capacity information, see engineering manual capacity tables. Capacities are based on connection of Non-Ducted indoor units.
- Values when matched with non-ducted units only.
- Recommended fuse size is 25 Amps.
- All power/communication wiring minimum 4-conductor, stranded, shielded, and must comply with applicable local and national codes.
- Installation of an optional Low Ambient Wind Baffle Kit will allow operation down to -4°F in cooling mode for applicable outdoor units.
- Sound pressure levels are tested in an anechoic chamber under ISO Standard 3745 and are the same in both cooling and heating mode. These values can increase due to ambient conditions during operation.
- Piping lengths are equivalent.
- Due to our commitment to continued innovation, some specifications may be changed without notification.

MULTI F INDOOR UNITS



ART COOL™ Gallery



Specification	Unit	LMAN097HVP	LMAN127HVP	
Capacity	Cooling	Btu/h	9,000	11,200
	Heating	Btu/h	10,400	13,300
Power	Voltage	V, Ø, Hz	208/230-1-60	208/230-1-60
	Power/Communication Wiring ⁴	No. x AWG	4 x 14	4 x 14
Operating Range	Cooling	°F WB	57 - 77	57 - 77
	Heating	°F DB	59 - 81	59 - 81
Fan	Type		Turbo	Turbo
	Motor Output x Qty	W	24 x 1	24 x 1
	Motor/Drive		BLDC	BLDC
	Airflow (H/M/L)	CFM	272/208/155	314/258/198
Unit Data	Rated Amps	A	0.2	0.2
	Sound Pressure Level (H/M/L) ³	dB(A)	39/35/31	42/38/34
	Dimensions (WxHxD)	in	23-5/8 x 23-5/8 x 5-25/32	23-5/8 x 23-5/8 x 5-25/32
	Weight (Net/Shipping)	lbs	32/37	32/37
Piping	Liquid Pipe	in	1/4	1/4
	Vapor Pipe	in	3/8	3/8
	Drain (OD, ID)	in	27/32, 5/8	27/32, 5/8
Controller	Supplied		AKB73635607	AKB73635607

Digital Airflow Control

The airflow can be controlled to ensure maximum comfort and convenience.

Normal

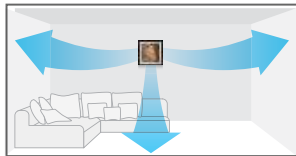

Jet Cool

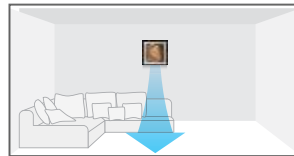

Sleep Mode

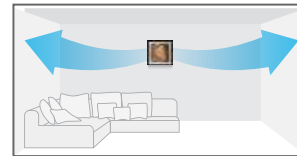

Customizable Picture Frame

With LG's revolutionary Art Cool Gallery, you can change the look of your air conditioner to whatever you want, whenever you want.



Note:

1. Rated capacity at 0 ft. above sea level with 25 ft. of refrigerant line and a 0 ft. level difference between outdoor and indoor unit.
2. Rated cooling capacity obtained with air entering the indoor unit at 80 °F dry bulb (DB) and 67 °F wet bulb (WB) and outdoor ambient conditions of 95 °F dry bulb (DB) and 75 °F wet bulb (WB).
Rated heating capacity obtained with air entering the indoor unit at 70 °F dry bulb (DB) and 60 °F wet bulb (WB) and outdoor ambient conditions of 47 °F dry bulb (DB) and 43 °F wet bulb (WB).
3. Sound pressure levels are tested in an anechoic chamber under ISO Standard 3745 and are the same in both cooling and heating mode. These values can increase due to ambient conditions during operation.
4. All power/communication wiring minimum 4-conductor, stranded, shielded, and must comply with applicable local and national codes.
5. Due to our commitment to continued innovation, some specifications may be changed without notification.

MULTI F INDOOR UNITS



ART COOL™ Mirror



Specification		Unit	LAN090HSV5	LAN120HSV5	LAN180HSV5
Capacity	Cooling	Btu/h	9,000	12,000	18,000
	Heating	Btu/h	10,900	13,600	21,600
Power	Voltage	V, Ø, Hz	208/230-1-60	208/230-1-60	208/230-1-60
	Power/Communication Wiring ⁴	No. x AWG	4 x 14	4 x 14	4 x 14
Operating Range	Cooling	°F WB	57 - 77	57 - 77	57 - 77
	Heating	°F DB	59 - 81	59 - 81	59 - 81
Fan	Type		Cross Flow	Cross Flow	Cross Flow
	Motor Output x Qty	W	30 x 1	30 x 1	60 x 1
	Motor/Drive		BLDC	BLDC	BLDC
	Airflow (H/M/L)	CFM	268/218/169	282/233/177	558/438/353
Unit Data	Rated Amps	A	0.4	0.4	0.4
	Sound Pressure Level (H/M/L) ³	dB(A)	36/32/27	38/34/29	44/38/34
	Dimensions (WxHxD)	in	32-15/16 x 12-1/8 x 7-9/16	32-15/16 x 12-1/8 x 7-9/16	39-9/32 x 13-19/32 x 8-11/32
	Weight (Net/Shipping)	lbs	20.5/25.6	20.5/25.6	29.8/36.4
Piping	Liquid Pipe	in	1/4	1/4	1/4
	Vapor Pipe	in	3/8	3/8	1/2
	Drain (OD/ID)	in	27/32, 5/8	27/32, 5/8	27/32, 5/8
Controller	Supplied		AKB74955602	AKB74955602	AKB74955602



High Efficiency



Specification		Unit	LMN079HVT	LSN090HSV5	LSN120HSV5	LMN159HVT	LSN180HSV5	LMN249HVT
Capacity	Cooling	Btu/h	7,000	9,000	12,000	14,300	18,000	24,000
	Heating	Btu/h	8,100	10,900	13,600	15,600	21,600	25,600
Power	Voltage	V, Ø, Hz	208/230-1-60	208/230-1-60	208/230-1-60	208/230-1-60	208/230-1-60	208/230-1-60
	Power/Communication Wiring ⁴	No. x AWG	4 x 14	4 x 14	4 x 14	4 x 14	4 x 14	4 x 14
Operating Range	Cooling	°F WB	57 - 77	57 - 77	57 - 77	57 - 77	57 - 77	57 - 77
	Heating	°F DB	59 - 81	59 - 81	59 - 81	59 - 81	59 - 81	59 - 81
Fan	Type		Cross Flow	Cross Flow	Cross Flow	Cross Flow	Cross Flow	Cross Flow
	Motor Output x Qty	W	30 x 1	30 x 1	30 x 1	30 x 1	60 x 1	60 x 1
	Motor/Drive		BLDC	BLDC	BLDC	BLDC	BLDC	BLDC
	Airflow (H/M/L)	CFM	254/204/148	268/218/169	282/233/177	314/268/184	558/438/353	597/452/367
Unit Data	Rated Amps	A	0.4	0.4	0.4	0.4	0.4	0.4
	Sound Pressure Level (H/M/L) ³	dB(A)	35/31/26	36/32/27	38/34/29	42/38/32	44/38/34	46/41/36
	Dimensions (WxHxD)	in	32-15/16 x 12-1/8 x 7-7/16	32-15/16 x 12-1/8 x 7-7/16	32-15/16 x 12-1/8 x 7-7/16	32-15/16 x 12-1/8 x 7-7/16	39-9/32 x 13-19/32 x 8-9/32	39-9/32 x 13-19/32 x 8-9/32
	Weight (Net/Shipping)	lbs	18.3 / 23.4	18.3 / 23.4	18.3 / 23.4	18.3 / 23.4	25.6 / 32.2	25.6 / 32.2
Piping	Liquid Pipe	in	1/4	1/4	1/4	1/4	1/4	1/4
	Vapor Pipe	in	3/8	3/8	3/8	3/8	1/2	1/2
	Drain (OD, ID)	in	27/32, 5/8	27/32, 5/8	27/32, 5/8	27/32, 5/8	27/32, 5/8	27/32, 5/8
Controller	Supplied		AKB74955602	AKB74955602	AKB74955602	AKB74955602	AKB74955602	

Note:

- Rated capacity at 0 ft. above sea level with 25 ft. of refrigerant line and a 0 ft. level difference between outdoor and indoor unit.
- Rated cooling capacity obtained with air entering the indoor unit at 80 °F dry bulb (DB) and 67 °F wet bulb (WB) and outdoor ambient conditions of 95 °F dry bulb (DB) and 75 °F wet bulb (WB).
Rated heating capacity obtained with air entering the indoor unit at 70 °F dry bulb (DB) and 60 °F wet bulb (WB) and outdoor ambient conditions of 47 °F dry bulb (DB) and 43 °F wet bulb (WB).
- Sound pressure levels are tested in an anechoic chamber under ISO Standard 3745 and are the same in both cooling and heating mode. These values can increase due to ambient conditions during operation.
- All power/communication wiring minimum 4-conductor; stranded, shielded, and must comply with applicable local and national codes.
- Due to our commitment to continued innovation, some specifications may be changed without notification.

MULTI F INDOOR UNITS

Ceiling Cassette



Specification	Unit	LMCN078HV	LCN098HV4	LCN128HV4	LCN188HV4	
Capacity	Cooling	Btu/h	7,000	9,000	12,000	18,000
	Heating	Btu/h	8,100	10,400	13,800	20,800
Power	Voltage	V, Ø, Hz	208/230-1-60	208/230-1-60	208/230-1-60	208/230-1-60
	Power/Communication Wiring ⁴	No. x AWG	4 x 14	4 x 14	4 x 14	4 x 14
Operating Range	Cooling	°F WB	57 - 77	57 - 77	57 - 77	57 - 77
	Heating	°F DB	59 - 81	59 - 81	59 - 81	59 - 81
Fan	Type		Turbo	Turbo	Turbo	Turbo
	Motor Output x Qty	W	43 x 1	43 x 1	43 x 1	43 x 1
	Motor/Drive		BLDC	BLDC	BLDC	BLDC
	Airflow (H/M/L)	CFM	265/212/177	300/265/230	335/283/247	459/424/388
Unit Data	Rated Amps	A	0.25	0.25	0.25	0.25
	Sound Pressure Level (H/M/L) ³	dB(A)	31/27/24	36/33/30	38/35/32	41/39/36
	Dimensions (WxHxD)	in	22-7/16 x 8-7/16 x 22-7/16	22-7/16 x 8-7/16 x 22-7/16	22-7/16 x 8-7/16 x 22-7/16	22-7/16 x 10-3/32 x 22-7/16
	Weight (Net/Shipping)	lbs	26/31	29/34	29/34	32/39
Piping	Liquid Pipe	in	1/4	1/4	1/4	1/4
	Vapor Pipe	in	3/8	3/8	3/8	1/2
	Drain (OD/ID)	in	1-1/4, 1	1-1/4, 1	1-1/4, 1	1-1/4, 1
Controller	Supplied ⁵		AKB73757604	AKB73757604	AKB73757604	AKB73757604
Grille (Sold Separately)	Model		PT-QCHW0/PT-UQC	PT-QCHW0/PT-UQC	PT-QCHW0/PT-UQC	PT-QCHW0/PT-UQC
	Dimensions (WxHxD)	in	27-9/16 x 7/8 x 27-9/16	27-9/16 x 7/8 x 27-9/16	27-9/16 x 7/8 x 27-9/16	27-9/16 x 7/8 x 27-9/16
	Weight (Net/Shipping)	lbs	7/11	7/9	7/9	7/11

Low Static Ducted



Specification	Unit	LDN097HV4	LDN127HV4	LDN187HV4	
Capacity	Cooling	Btu/h	9,000	12,000	18,000
	Heating	Btu/h	10,400	13,800	20,800
Power	Voltage	V, Ø, Hz	208/230-1-60	208/230-1-60	208/230-1-60
	Power/Communication Wiring ⁴	No. x AWG	4 x 14	4 x 14	4 x 14
Operating Range	Cooling	°F WB	57 - 77	57 - 77	57 - 77
	Heating	°F DB	59 - 81	59 - 81	59 - 81
Fan	Type		Sirocco	Sirocco	Sirocco
	Motor Output x Qty	W	19 x 1	5 x 1, 19 x 1	5 x 1, 19 x 1
	Motor/Drive		BLDC	BLDC	BLDC
	Airflow (H/M/L)	CFM	318/247/194	353/300/247	530/441/353
Unit Data	Rated Amps	A	0.4	0.8	0.8
	Factory Set External Static Pressure	in. wg	0.1	0.1	0.1
	Max. External Static Pressure	in. wg	0.2	0.2	0.2
	Sound Pressure Level (H/M/L) ³	dB(A)	30/26/23	31/28/27	36/34/31
	Dimensions (WxHxD)	in	27-9/16 x 7-15/32 x 27-9/16	35-7/16 x 7-15/32 x 27-9/16	35-7/16 x 7-15/32 x 27-9/16
Piping	Weight (Net/Shipping)	lbs	39/46	51/60	51/57
	Liquid Pipe	in	1/4	1/4	1/4
	Vapor Pipe	in	3/8	3/8	1/2
	Drain (OD/ID)	in	1-1/4, 1	1-1/4, 1	1-1/4, 1
Controller	Additional Accessory ⁵		Wired Controller	Wired Controller	Wired Controller

- Note:
- Rated capacity at 0 ft. above sea level with 25 ft. of refrigerant line and a 0 ft. level difference between outdoor and indoor unit.
 - Rated cooling capacity obtained with air entering the indoor unit at 80°F dry bulb (DB) and 67°F wet bulb (WB) and outdoor ambient conditions of 95°F dry bulb (DB) and 75°F wet bulb (WB).
Rated heating capacity obtained with air entering the indoor unit at 70°F dry bulb (DB) and 60°F wet bulb (WB) and outdoor ambient conditions of 47°F dry bulb (DB) and 43°F wet bulb (WB).
 - Sound pressure levels are tested in an anechoic chamber under ISO Standard 3745 and are the same in both cooling and heating mode. These values can increase due to ambient conditions during operation.
 - All power/communication wiring minimum 4-conductor, stranded, shielded, and must comply with applicable local and national codes.
 - All LG wired controls are compatible and can be considered for control.
 - Due to our commitment to continued innovation, some specifications may be changed without notification.

MULTI F INDOOR UNITS



High Static Ducted

Specification		Unit	LHN248HV	LHN368HV
Capacity	Cooling	Btu/h	24,000	36,000
	Heating	Btu/h	27,000	40,000
Power	Voltage	V, Ø, Hz	208/230-1-60	208/230-1-60
	Power/Communication Wiring ⁴	No. x AWG	4 x 14	4 x 14
Operating Range	Cooling	°F WB	57 - 77	57 - 77
	Heating	°F DB	59 - 81	59 - 81
Fan	Type		Sirocco	Sirocco x 2
	Motor Output x Qty	W	136.5 x 1	259 x 1
	Motor/Drive		BLDC	BLDC
	Airflow (H/M/L)	CFM	777/706/636	1,130/989/848
Unit Data	Rated Amps	A	1.6	2.3
	Factory Set External Static Pressure	in. wg	0.24	0.24
	Max. External Static Pressure	in. wg	0.59	0.59
	Sound Pressure Level (H/M/L) ³	dB(A)	37/35/34	44/42/40
	Dimensions (WxHxD)	in	35-7/16 x 10-5/8 x 27-9/16	49-3/16 x 10-5/8 x 27-9/16
Piping	Weight (Net/Shipping)	lbs	59/72	86/100
	Liquid Pipe	in	1/4	3/8
	Vapor Pipe	in	1/2	5/8
Controller	Drain (OD/ID)	in	1-1/4, 1	1-1/4, 1
	Additional Accessory ⁶		Wired Controller	Wired Controller



Vertical AHU

Specification		Unit	LVN181HV4	LVN241HV4	LVN361HV4
Capacity	Cooling	Btu/h	18,000	24,000	36,000
	Heating	Btu/h	20,000	27,000	40,000
Power	Voltage	V, Ø, Hz	208/230-1-60	208/230-1-60	208/230-1-60
	Power/Communication Wiring ⁵	No. x AWG	4 x 14	4 x 14	4 x 14
Operating Range	Cooling	°F WB	57 - 77	57 - 77	57 - 77
	Heating	°F DB	59 - 81	59 - 81	59 - 81
Fan	Type		Sirocco	Sirocco	Sirocco
	Motor Output x Qty	W	250 x 1	250 X 1	250 x 1
	Motor/Drive		Constant CFM ECM	Constant CFM ECM	Constant CFM ECM
	Airflow (H/M/L)	CFM	640/580/480	710/640/480	990/880/800
Unit Data	Rated Amps	A	1.1	1.1	1.1
	Max. External Static Pressure	in. wg	0.7	0.7	0.7
	Sound Pressure Level (H/M/L) ⁴	dB(A)	35/33/30	36/34/30	44/41/39
	Dimensions (WxHxD)	in	18 x 48-11/16 x 21-1/4	18 x 48-11/16 x 21-1/4	18 x 48-11/16 x 21-1/4
	Weight (Net/Shipping)	lbs	124/136	124/136	129/140
Piping	Liquid Pipe	in	1/4	1/4	3/8
	Vapor Pipe	in	1/2	1/2	5/8
	Drain	in	Primary & Secondary: 3/4 FPT	Primary & Secondary: 3/4 FPT	Primary & Secondary: 3/4 FPT
Controller	Additional Accessory ⁶		Wired Controller	Wired Controller	Wired Controller

Note:

1. Rated capacity at 0 ft. above sea level with 25 ft. of refrigerant line and a 0 ft. level difference between outdoor and indoor unit.

2. Rated cooling capacity obtained with air entering the indoor unit at 80° F dry bulb (DB) and 67° F wet bulb (WB) and outdoor ambient conditions of 95° F dry bulb (DB) and 75° F wet bulb (WB).
Rated heating capacity obtained with air entering the indoor unit at 70° F dry bulb (DB) and 60° F wet bulb (WB) and outdoor ambient conditions of 47° F dry bulb (DB) and 43° F wet bulb (WB).

3. Sound pressure levels are tested in an anechoic chamber under ISO Standard 3745 and are the same in both cooling and heating mode. These values can increase due to ambient conditions during operation.





4. All power/communication wiring minimum 4-conductor, stranded, shielded, and must comply with applicable local and national codes.

5. All LG wired controls are compatible and can be considered for control.

6. Due to our commitment to continued innovation, some specifications may be changed without notification.

MULTI F MAX PIPING ACCESSORIES

Accessory Lineup

For	2 IDUs	3 IDUs	4 IDUs	4 IDUs
Branch Distribution Unit	 PMBD3620	 PMBD3630	 PMBD3640	 PMBD3641
Y-Branch	 PMBL5620			

Branch Distribution Unit Features

- Distribution of refrigerant to various indoor units
- 4 models (2, 3, 4 indoor units)
- Integral EEVs
- Controlling PCB inside the unit
- Internally insulated (prevents condensation)
- Flare joints for easy and clean installation
- Compact design (low height)
- Flexible installation

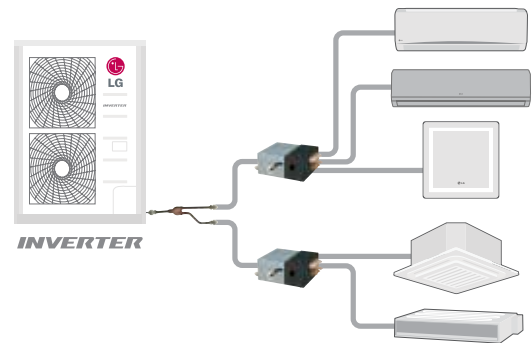

Specifications

Specification		Unit	PMBD3620	PMBD3630	PMBD3640	PMBD3641
Max Nominal Port Capacity	Each Port	Btu/h	24,000	24,000	24,000	Ports A ~ C: 24,000 Port D: 36,000
	Sum of Ports	Btu/h	48,000	72,000	73,000	73,000
Connectable Indoor Units			1 ~ 2	1 ~ 3	1 ~ 4	1 ~ 4
Operating Range		°F DB	0 ~ 150	0 ~ 150	0 ~ 150	0 ~ 150
Voltage		V, Ø, Hz	208/230-1-60	208/230-1-60	208/230-1-60	208/230-1-60
Power Input		W	16	24	32	32
Rated Amps		A	0.08	0.12	0.16	0.16
Dimensions	WxHxD	inch	17-3/32 x 6-13/32 x 10-23/32	17-3/32 x 6-13/32 x 10-23/32	17-3/32 x 6-13/32 x 10-23/32	17-3/32 x 6-13/32 x 10-23/32
	Weight					
Pipe Connection Size (In from ODU)	Liquid	in	3/8	3/8	3/8	3/8
	Vapor	in	3/4	3/4	3/4	3/4
Pipe Connection Size (Out to IDU)	Liquid	in	1/4 (x2)	1/4 (x3)	1/4 (x4)	Ports A ~ C: 1/4 Port D: 1/4
	Vapor	in	3/8 (x2)	3/8 (x3)	3/8 (x4)	Ports A ~ C: 3/8 Port D: 1/2
Max Pipe Length	BD Box to IDU	ft	49.2	49.2	49.2	49.2
Max Pipe Elevation	BD Box to IDU	ft	32.8	32.8	32.8	32.8
	BD Box to BD Box	ft	49.2	49.2	49.2	49.2

Note :

1. Branch Distribution Unit should be installed indoors.
2. Due to our commitment to continued innovation, some specifications may be changed without notification.

MULTI F PIPING SUMMARY

The following are examples of manual pipe size calculations. Designers are strongly encouraged to use LATS for Multi F systems.

Multi F System

Example shown: LMU36CHV outdoor unit with four (4) indoor units connected.

Model Number	Min Length Each Pipe (ft.)	Maximum Piping Length to each IDU (ft.)				Max. Total Piping Length for Each System (ft.)
		A	B	C	D	
LMU18CHV	10	82	82	-	-	164
LMU24CHV	10	82	82	82	-	246.1
LMU30CHV	10	82	82	82	82	246.1
LMU36CHV	10	82	82	82	82	246.1

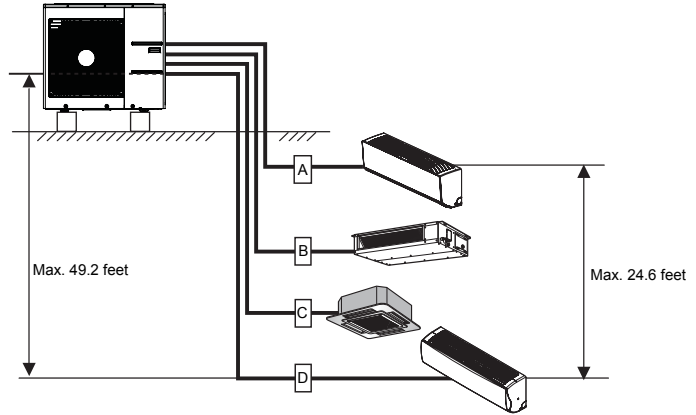

Multi F MAX System

Example: LMU540HV outdoor unit with seven (7) indoor units, and two (2) branch distribution units connected.

A, B, C, D: Pipes from Outdoor Unit to Indoor Unit

Pipe Length (ELF = Equivalent Length of pipe in Feet)	Total System Pipe Length ($\Sigma A + \Sigma B$)		≤ 475.7 feet
	Main pipe (Outdoor Unit to Branch Distribution Units: ΣA)	Minimum per segment	10 feet
		Maximum	≤ 180.4 feet
	Total Branch Pipe Length (ΣB)		≤ 295.3 feet
Elevation Differential (All Elevation Limitations are Measured in Actual Feet)	Branch pipe (Branch Distribution Units to Indoor Units: ΣB)	Minimum	10 feet
		Maximum	≤ 49.2 feet
	If outdoor unit is above or below indoor unit ($h1$)		≤ 98.4 feet
	Between the farthest two indoor units ($h2$)		≤ 49.2 feet
	Between branch distribution unit and farthest connected indoor unit(s) ($h3$)		≤ 32.8 feet
Between branch distribution units ($h4$)		≤ 49.2 feet	

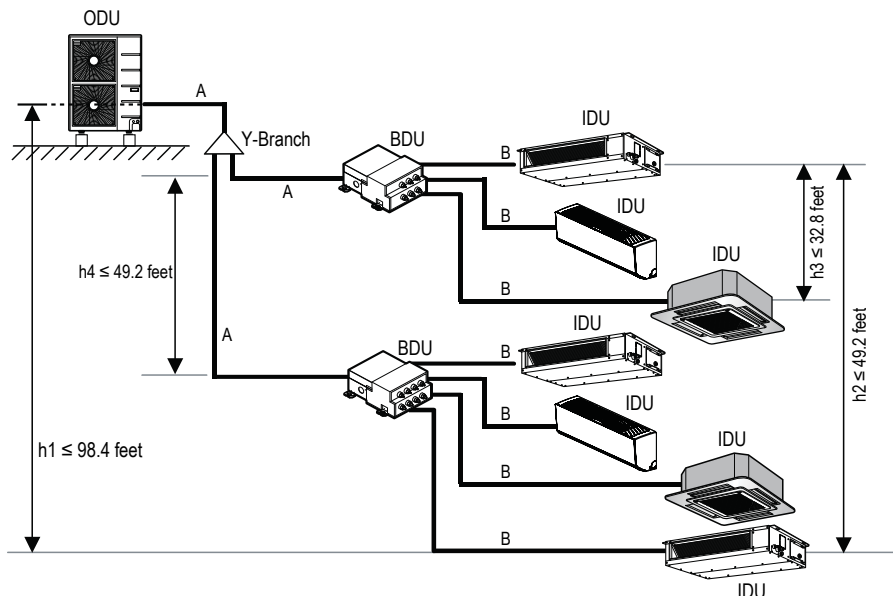

KEY:

ODU: Outdoor Unit
 IDU: Indoor Unit
 BDU: Branch Distribution Unit (s)
 A, B, C, D: Pipes from ODU to IDU

ΣA : Main Pipe
 ΣB : Branch Pipe (BDU(s) to IDU(s))

CONTROLS

Individual Control



Model	Description
PREMTC00U	Simple Wired Remote Controller
PQWRHQ0FDB	Wireless Remote Controller
PREMTA000	Premium Wired Remote Controller
PREMTBVC0	LG MultiSITE™ Remote Controller
PREMTBVC1	LG MultiSITE™ Remote Controller with Occupancy Sensor
ZRTBS01	Remote Temperature Button Sensor

LG MultiSITE™ Remote Controller Accessories



Model	Description
ZVRCZPWC1	ZigBee Pro Wireless Card
ZVRCZDWS1	Wireless Door & Window Switch
ZVRCZWOC1	Wireless Ceiling Mounted Occupancy Sensor
ZVRCZCOC1	Wireless Wall Mounted Occupancy Sensor

Integration Devices



Model	Description
PBACNBTR0	LG MultiSITE™ Communications Manager
PDRYCB100	Simple Dry Contact
PDRYCB300	Dry Contact for Thermostat (5-12Vdc, 24Vac)
PDRYCB400	Dry Contact for Economizer/Setback
PLNWKB100	LonWorks® Gateway
PQNFB17C2	ACP BACnet® Gateway
PMNFP14A1	PI 485 for DFS
PZCWRC1	32.8' Wired Remote Extension Cable
PZCWRCG3	Group Control Cable Kit (required for each additional A/H with single zone controller)
PACP5A000	ACP 5
PACS5A000	AC Smart™ 5

ACCESSORIES

Indoor Accessories



Type	Model	Description	Used with
Wi-Fi Module	PWFMD200	Connects to CN_WF or CN_WiFi depending on how the unit's board is marked	See Compatibility Table
Aux Heater Relay Kit	PRARH1	Auxiliary Heat Kit for Cassettes & Ducted IDUs	See Compatibility Table
	PRARH0	Auxiliary Heat Kit for Cassettes & Ducted IDUs	See Compatibility Table
	PRARS1	Auxiliary Heat Kit for Wall Mounted IDUs	See Compatibility Table
Auto Elevation Grille	PTEGM0	Auto Elevation Grille Kit	LCN***HV ¹
Cassette Cover	PTDCM	Decorative Cover for 4-Way Ceiling Cassettes Using PT-UMC1 Grille	LCN***HV ¹
	PTDCQ	Decorative Cover for 4-Way Ceiling Cassettes Using PT-UQC Grille	LMCN***HV, LCN***HV4
Cassette Grille	PT-MCHW0	4-Way Ceiling Cassette Matte Grille	LCN***HV ¹
	PT-QCHW0	4-Way Ceiling Cassette 2X2 Matte Grille	LMCN***HV, LCN***HV4
Cassette Ventilation	PTVK410	Ventilation Air Intake Spacer for 4-Way Ceiling Cassettes (requires PTVK420)	LCN***HV ¹
	PTVK420	6" Ø Ventilation Air Connection for 4-Way Ceiling Cassettes (requires PTVK410)	LCN***HV ¹
	PTVK430	3" Ø Ventilation Air Connection for all 4-Way Ceiling Cassettes	All 4-Way Ceiling Cassettes
VAHU Heat Kit	ANEH033B1	3 kW Electric Heat Kit for VAHU	LVN**1HV4, LVN***HV
	ANEH053B1	5 kW Electric Heat Kit for VAHU	LVN**1HV4, LVN***HV
	ANEH083B2	8 kW Electric Heat Kit for VAHU	LVN**1HV4, LVN***HV
	ANEH103B2	10 kW Electric Heat Kit for VAHU	LVN**1HV4, LVN***HV
	ANEH153B2	15 kW Electric Heat Kit for VAHU	LVN***HV
VAHU Vertical Down Flow Conversion Kit	ANEH203B2	20 kW Electric Heat Kit for VAHU	LVN***HV
	PNDFJ0	Vertical Down Flow Conversion Kit	LVN**1HV4
HSD Filter Box	PNDFK0	Vertical Down Flow Conversion Kit	LVN***HV
	FBXM201A	High-capacity filter box for M2 chassis	LHN368HV
	FBXM101A	High-capacity filter box for M1 chassis	LHN248HV

Note:
 1. Accessory is not compatible with LCN***HV4 models.
 2. Due to our commitment to continued innovation, some specifications may be changed without notification.

ACCESSORIES

Outdoor Accessories



Base Pan Heater



Wind Baffle

Category	Model	Description	Used with
Wind Baffle	ZLABGP01A	Wind Baffle for Low Ambient Cooling	9kBtu & 12kBtu HSV5, HYV1, LUU***HV
	ZLABGP02A	Wind Baffle for Low Ambient Cooling	15kBtu+ HYV1, HYV2, HSV5, HLV
	ZLABGP03A	Wind Baffle for Low Ambient Cooling	24kBtu HSV3
	ZLABGP04A	Wind Baffle for Low Ambient Cooling	LMU18CHV, LMU24CHV LMU30CHV, LMU36CHV, LUU18*HV, LUU24*HV Multi F MAX, LUU36*HV, LUU42*HV, LUU48*HV ¹
Base Pan Heater	PQSH1200	Base Pan Heater for Multi F and Single Zone (Cassette & Ducted styles)	All Multi F and Multi F MAX Outdoor Units LUU18*HV, LUU24*HV, LUU36*HV, LUU42*HV, LUU48*HV ³
	PQSH1201	Base Pan Heater for Single Zone (Wall Mounted styles)	LSU180HSV5, LAU240HSV3 ² , LSU303HLV, LSU363HLV
	PQSH1202	Base Pan Heater for Single Zone (Cassette & Ducted styles)	LUU09*HV, LUU12*HV ⁴
AHU Comm Kit	PAHCMR000	AHU Comm Kit (Return Air)	LUU18(7-9)HV+

Air Technologies



ARVU053ZEA2 / ARVU063ZEA2



ARVU093ZFA2 / ARVU123ZFA2



PSNFP14A0



PES-C0RV0

Category	Model	Description
ERV	ARVU053ZEA2	Energy Recovery Ventilator 465 cfm
	ARVU063ZEA2	Energy Recovery Ventilator 600 cfm
	ARVU093ZFA2	Energy Recovery Ventilator 900 cfm
	ARVU123ZFA2	Energy Recovery Ventilator 1,200 cfm
ERV Accessory	PSNFP14A0	PI485 for ERV (INDOOR)
	PES-C0RV0	CO ₂ Sensor

Note:

- Multi F MAX, LUU36*HV, LUU42*HV, and LUU48*HV require Qty 2 of ZLABGP04A.
- Base Pan Heater is factory supplied for outdoor units featuring LGRED[®] heat and 9k and 12k Btu/h LSU***HSV5 outdoor units
- Base Pan Heater is compatible with Multi F and Multi F MAX units manufactured after May 2015 and listed LUU***HV models manufactured after April 2017.
- Only applicable with units manufactured after February 2018.
- Due to our commitment to continued innovation, some specifications may be changed without notification.

CONTROLS & ACCESSORIES COMPATIBILITY

Indoor Accessories



Single Zone		Wi-Fi Module ²	LG MultiSITE™ Remote Controllers	Simple Remote Controller	Dry Contact (Setback)	Dry Contact (Thermostat)	Remote Temp/ Button Sensor	Group Control	Cable Extension	Aux Heater Relay Kit	Aux Heater Relay Kit
		PWFMD200	PREMTBVC1 PREMTBVC0	PREMTC00U	PDRYCB400	PDRYCB300	ZRTBS01	PZCWRCG3	PZCWRC1	PRARS1	PRARH(0/1)
Mega	LS---HEV2	X	X	X	X	X	X	X	X	X	-
Mega 115V	LS---HXV2	X	0	0	0	0	X	X	0	X	-
High Efficiency	LS---HSV5	Built-in	0	0	0	0	X	X	0	X	-
Longpipe	LS---3HLV	Built-in	0	0	0	0	X	X	0	X	-
Art Cool™ Mirror	LA---HSV5	Built-in	0	0	0	0	X	X	0	X	-
Art Cool™ Premier	LA-HYV1	0	0	0	0	0	X	X	0	X	-
	LA-HYV2	0	0	0	0	0	X	X	0	X	-
Cassette	LC---HV4	0	0	0	0	0	0	0	0	-	0
	LC---HV	0	0	0	0	0	0	0	0	-	0
Ducted	LH-8HV	0	0	0	0	0	0	0	0	-	0
	LD---HV4	0	0	0	0	0	0	0	0	-	0
Vertical AHU	LV--1HV4	0	0	0	0	Built-in	0	0	0	-	0
	LV---HV	0	0	0	0	Built-in	0	0	0	-	X
Multi-Zone		Wi-Fi Module ²	LG MultiSITE™ Remote Controllers	Simple Remote Controller	Dry Contact (Setback)	Dry Contact (Thermostat)	Remote Temp Button Sensor	Group Control	Cable Extension	Aux Heater Relay Kit	Aux Heater Relay Kit
		PWFMD200	PREMTBVC1 PREMTBVC0	PREMTC00U	PDRYCB400	PDRYCB300	ZRTBS01	PZCWRCG3	PZCWRC1	PRARS1	PRARH(0/1)
High Efficiency	LMN079HVT	Built-in	0	0	0	0	X	0	0	0	-
	LSN090HSV5	Built-in	0	0	0	0	X	0	0	0	-
	LSN120HSV5	Built-in	0	0	0	0	X	0	0	0	-
	LMN159HVT	Built-in	0	0	0	0	X	0	0	0	-
	LSN180HSV5	Built-in	0	0	0	0	X	0	0	0	-
Art Cool™ Mirror	LMN249HVT	Built-in	0	0	0	0	X	0	0	0	-
	LAN090HSV5	Built-in	0	0	0	0	X	0	0	0	-
	LAN120HSV5	Built-in	0	0	0	0	X	0	0	0	-
Art Cool™ Gallery	LAN180HSV5	Built-in	0	0	0	0	X	0	0	0	-
	LMAN097HVP	0	0	0	0	0	X	0	0	0 ¹	-
Cassette	LMAN127HVP	0	0	0	0	0	X	0	0	0 ¹	-
	LMCN078HV	0	0	0	0	0	0	0	0	-	0
Low Static Duct	LCN098HV4	0	0	0	0	0	0	0	0	-	0
	LCN128HV4	0	0	0	0	0	0	0	0	-	0
	LCN188HV4	0	0	0	0	0	0	0	0	-	0
	LDN097HV4	0	0	0	0	0	0	0	0	-	0
High Static Duct	LDN127HV4	0	0	0	0	0	0	0	0	-	0
	LDN187HV4	0	0	0	0	0	0	0	0	-	0
Vertical AHU	LHN248HV	0	0	0	0	0	0	0	0	-	0
	LHN368HV	0	0	0	0	0	0	0	0	-	0
Vertical AHU	LVN181HV4	0	0	0	0	Built-in	0	0	0	-	0
	LVN241HV4	0	0	0	0	Built-in	0	0	0	-	0
	LVN361HV4	0	0	0	0	Built-in	0	0	0	-	0

Note:

"0" in a cell indicates available; "X" indicates not available; "-" indicates not applicable.

Some IDUs have a control wire terminal block to connect a wired controller with field-supplied control cable instead of the LG control cable (with Molex connection). See IDU engineering manual or installation manual for details.

1. Emergency Heat function is not available with Aux Heat Relay Kit.

2. LG is committed to expanding Wi-Fi Module compatibility throughout our products. For the most updated Wi-Fi Module compatibility chart, please visit www.lg-dfs.com

3. Due to our commitment to continued innovation, some specifications may be changed without notification.

CONTROLS & ACCESSORIES COMPATIBILITY

Outdoor Accessories & Service Accessories



PBACNBTR0A



PMNFP14A1



PACSSA000



PACP5A000



PQNF17C2



PLNWKB100



PSWMOZ3



PLGMVW100

Single Zone		PI485 for ODU	PDI Premium & Standard	AC Smart5 Central Control	ACP 5 Central Control	LG MultiSITE™ Communications Manager	AC Smart BACnet*	ACP IV BACnet*	ACP LonWorks*	LG SIMS	LGMV Hard Lock Key & Cable	Mobile LGMV†
		PMNFP14A1	PQNUD1S41 PPWRDB000	PACSSA000	PACP5A000	PBACNBTR0A	PBACNA000	PQNF17C2	PLNWKB100	PSWMOZ3	PRCTILO	PLGMVW100
Mega	LS---HEV1	X	X	X	X	X	X	X	X	0	0	X
Mega 115V	LS---HXV	X	X	X	X	X	X	X	X	0	0	X
Standard	LS---HSV5	0	0	0	0	0	0	0	0	0	0	X
Longpipe	LS---HLV	0	0	0	0	0	0	0	0	0	0	X
Art Cool™ Mirror	LA---HSV5	0	0	0	0	0	0	0	0	0	0	X
	LA090HYV1 LA120HYV1	X	X	X	X	X	X	X	X	0	0	X
Art Cool™ Premier	LA180HYV1 LA240HYV1	0	0	0	0	0	0	0	0	0	0	X
	LA---HYV2	0	0	0	0	0	0	0	0	0	0	X
Cassette	LC---HV4	0	0	0	0	0	0	0	0	0	0	X
	LC---HV	0	0	0	0	0	0	0	0	0	0	X
Ducted	LH---HV	0	0	0	0	0	0	0	0	0	0	X
	LD---HV4	0	0	0	0	0	0	0	0	0	0	X
Vertical AHU	LV---HV4	0	0	0	0	0	0	0	0	0	0	X
	LV---HV	0	0	0	0	0	0	0	0	0	0	X
Multi-Zone		PI485 for ODU	PDI Premium & Standard	AC Smart5 Central Control	ACP 5 Central Control	MultiSITE Communications Manager	AC Smart BACnet*	ACP IV BACnet*	ACP LonWorks*	LG SIMS	LGMV Hard Lock Key & Cable	Mobile LGMV
		PMNFP14A1	PQNUD1S41 PPWRDB000	PACSSA000	PACP5A000	PBACNBTR0A	PBACNA000	PQNF17C2	PLNWKB100	PSWMOZ3	PRCTILO	PLGMVW100
Multi F	LMU18CHV	0	0	0	0	0	0	0	0	0	0	0
	LMU180HHV	0	0	0	0	0	0	0	0	0	0	0
	LMU24CHV	0	0	0	0	0	0	0	0	0	0	0
	LMU240HHV	0	0	0	0	0	0	0	0	0	0	0
	LMU30CHV	0	0	0	0	0	0	0	0	0	0	0
	LMU300HHV	0	0	0	0	0	0	0	0	0	0	0
	LMU36CHV	0	0	0	0	0	0	0	0	0	0	0
Multi F MAX	LMU360HHV	0	0	0	0	0	0	0	0	0	0	0
	LMU420HHV	0	0	0	0	0	0	0	0	0	0	0
	LMU480HV	0	0	0	0	0	0	0	0	0	0	0
	LMU540HV	0	0	0	0	0	0	0	0	0	0	0
	LMU600HV	0	0	0	0	0	0	0	0	0	0	0

Note:

"0" in a cell indicates available; "X" indicates not available; "-" indicates not applicable

1. Mobile LGMV consists of the wifi module with connecting cable (PLGMVW100) and the LGMV App running on an Android device (smartphone or table).

2. Due to our commitment to continued innovation, some specifications may be changed without notification.

ENERGY STAR® SYSTEMS

With several models winning the ENERGY STAR® Most Efficient designation, LG Air Conditioning Systems have industry-leading SEER and HSPF ratings.



Single Zone Systems

AHRI Reference Number	Outdoor	Indoor	EER 95° F	SEER	HSPF	Most Efficient ¹
7947563	LAU090HYV1	LAN090HYV1	15.65	27.50	12.00	★
7849625	LAU120HYV1	LAN120HYV1	13.80	25.50	12.00	★
9680935	LAU150HYV2	LAN150HYV2	13.50	24.00	12.50	★
8584525	LAU180HYV1	LAN180HYV1	13.50	24.00	12.50	★
9680934	LAU180HYV2	LAN180HYV2	12.50	22.00	12.00	★
8584526	LAU240HYV1	LAN240HYV1	12.50	22.00	12.00	★
10567393	LSU090HSV5	LAN090HSV5	14.50	23.50	11.30	★
10570122	LSU120HSV5	LAN120HSV5	12.50	22.70	11.40	★
10567390	LSU180HSV5	LAN180HSV5	12.60	21.50	10.20	★
10567394	LSU090HSV5	LSN090HSV5	14.50	23.50	11.30	★
10570123	LSU120HSV5	LSN120HSV5	12.50	22.70	11.40	★
10567391	LSU180HSV5	LSN180HSV5	12.60	21.50	10.20	★
9122552	LSU243HLV	LSN243HLV	12.50	21.50	11.00	★
203381526	LUU097HV	LCN098HV4	13.65	20.20	10.50	
203381517	LUU127HV	LCN128HV4	12.60	19.40	10.40	
202177384	LUU189HV	LCN188HV	12.50	20.50	10.10	
203161150	LUU249HV	LCN248HV	12.60	20.00	10.50	
203161151	LUU369HV	LCN368HV	12.50	19.00	9.50	
203161351	LUU189HV	LVN181HV4	13.30	19.20	10.40	
203161352	LUU249HV	LVN241HV4	12.00	19.50	11.00	
203162003	LUU369HV	LVN361HV4	11.00	18.00	10.00	

Multi-Zone Systems

AHRI Reference Number	Outdoor	Indoor	EER 95° F	SEER	HSPF
7180060	LMU18CHV	Non-Ducted Indoor Units	13.00	22.00	9.70
10445372	LMU180HHV	Non-Ducted Indoor Units	13.50	21.00	10.00
7180062	LMU24CHV	Non-Ducted Indoor Units	13.50	21.70	10.60
7184507	LMU24CHV	Mixed Ducted and Non-ducted Indoor Units	12.50	19.60	10.20
10445374	LMU240HHV	Non-Ducted Indoor Units	13.50	21.00	10.70
8111355	LMU30CHV	Non-Ducted Indoor Units	13.00	22.00	10.00
10445376	LMU300HHV	Non-Ducted Indoor Units	12.50	20.00	11.00
7180063	LMU36CHV	Non-Ducted Indoor Units	13.00	22.00	10.00
10443472	LMU360HHV	Non-Ducted Indoor Units	15.00	21.00	11.50
10443475	LMU360HHV	Ducted Indoor Units	13.50	17.50	10.50
10443471	LMU420HHV	Non-Ducted Indoor Units	14.00	20.50	11.00
10443474	LMU420HHV	Ducted Indoor Units	13.00	19.00	10.50
8111358	LMU480HV	Non-Ducted Indoor Units	12.50	19.50	10.00

Note:

1. Indicates unit is listed as ENERGY STAR® Most Efficient 2019. List is current as of January 2019. For the most up-to-date list of ENERGY STAR® and ENERGY STAR® Most Efficient models, visit the AHRI Directory at ahridirectory.org.



ENERGY STAR® is a joint program of the U.S. Environmental Protection Agency (EPA) and the U.S. Department of Energy (DOE) created to promote energy-efficient products and practices. The ENERGY STAR® logo helps homeowners identify which products meet energy efficiency performance levels set by U.S. EPA and U.S. DOE.

Select LG air conditioning systems may make homeowners eligible for equipment-related tax benefits and credits. Visit rebates.lghvac.com to see if your LG air conditioning system qualifies.

HOW TO READ LG MODEL NUMBERS

SINGLE ZONE SYSTEMS – INDOOR/OUTDOOR

L	A	N	09	0	H	YV	1
Brand	Family	Component	Nominal Capacity	Generation	Cycle	Product Type	Features

Brand	L	LG						
Family	A	Art Cool™ Wall Mounted	C	Four-Way Ceiling Cassette	D	Ceiling-Concealed Duct (Low Static)	H	Ceiling-Concealed Duct (High Static)
			S	Standard Wall Mounted	U	Cassette/Duct ODU	V	Vertical Air Handling Unit
Component	N	Indoor Unit					U	Outdoor Unit
Nominal Capacity	09	9,000	12	12,000	15	15,000	18	18,000
			24	24,000	30	30,000	36	36,000
			42	42,000	48	48,000		
Generation	0-8							
Cycle	H	Heat Pump						
Product Type	EV	Mega Inverter	LV	Extended Pipe Inverter	SV	Art Cool™ Mirror Inverter & High-Efficiency Inverter	V	Standard Inverter
							XV	Mega 115V Inverter
							YV	Art Cool™ Premier Inverter
Features	1-2-3-4-5	Model-Specific Features/Improvements						

MULTI-ZONE SYSTEMS – INDOOR/OUTDOOR¹

L	M	N	15	9	HV	T
Brand	Family	Product	Nominal Capacity	Generation	Cycle/Type	Style

Brand	L	LG				
Family	M	Multi-Zone				
Product	AN	Art Cool™ Wall Mounted Indoor Unit	CN	Four-Way Ceiling-Cassette Indoor Unit	DN	Ceiling-Concealed Duct (Low Static) Indoor Unit
	HN	Ceiling-Concealed Duct (High Static) Indoor Unit	N	Standard Wall Mounted Indoor Unit	VN	Vertical-Horizontal Air Handling Indoor Unit
			U	Outdoor Unit		
Nominal Capacity	07	7,000	09	9,000	12	12,000
			15	15,000	18	18,000
			24	24,000	30	30,000
			36	36,000	48	48,000
			54	54,000	60	60,000
Generation	0-5-6-7-8-9-C					
Cycle/Type	HV	Inverter Heat Pump	HHV	High Heat (LGRED®) Inverter Heat Pump		
Style	P	Art Cool™ Gallery IDU	T	High Wall IDU		

Note:

1. Multi-compatible Single Zone IDU nomenclature is conveyed in the Single Zone Systems Section.

NOTES

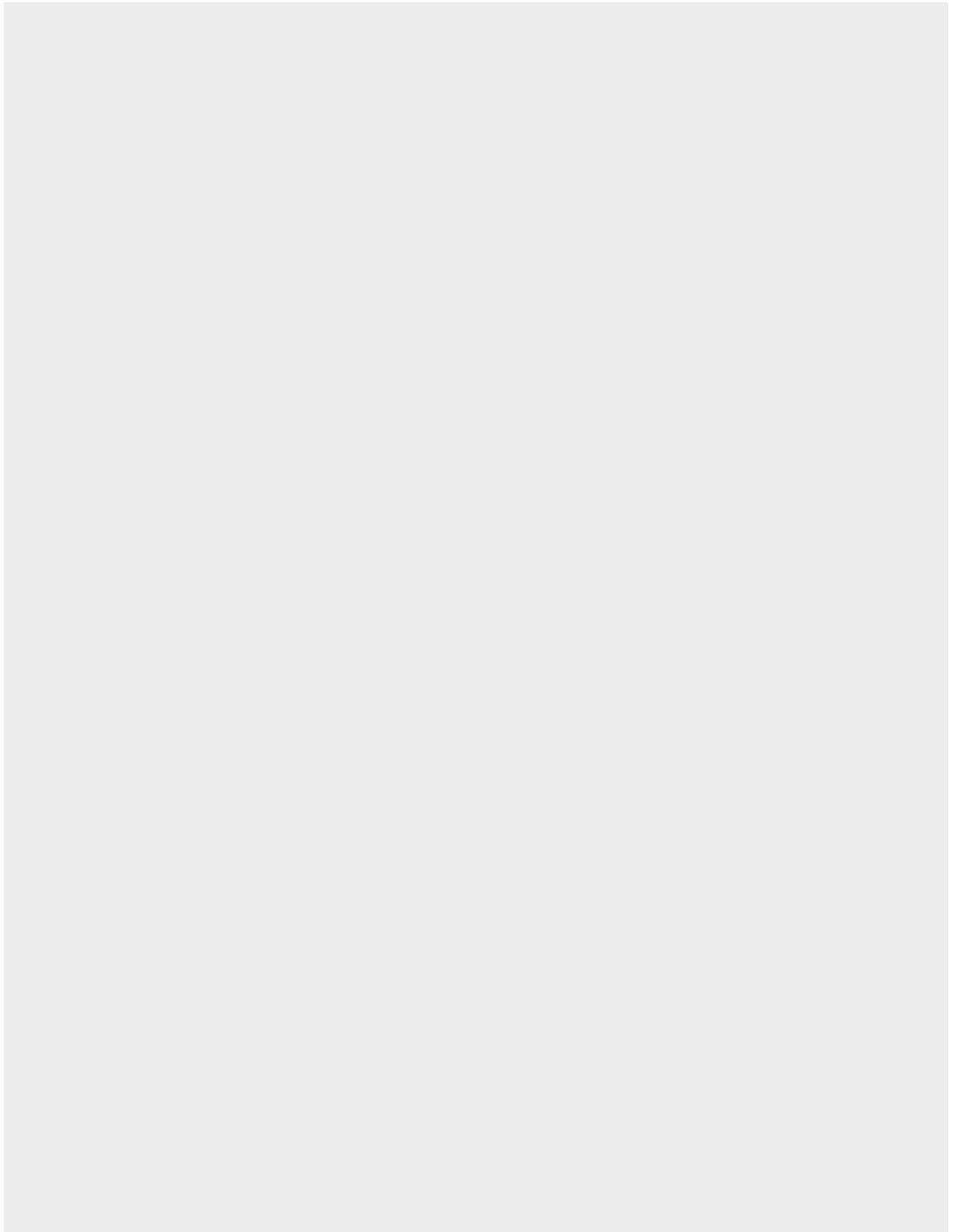

NOTES

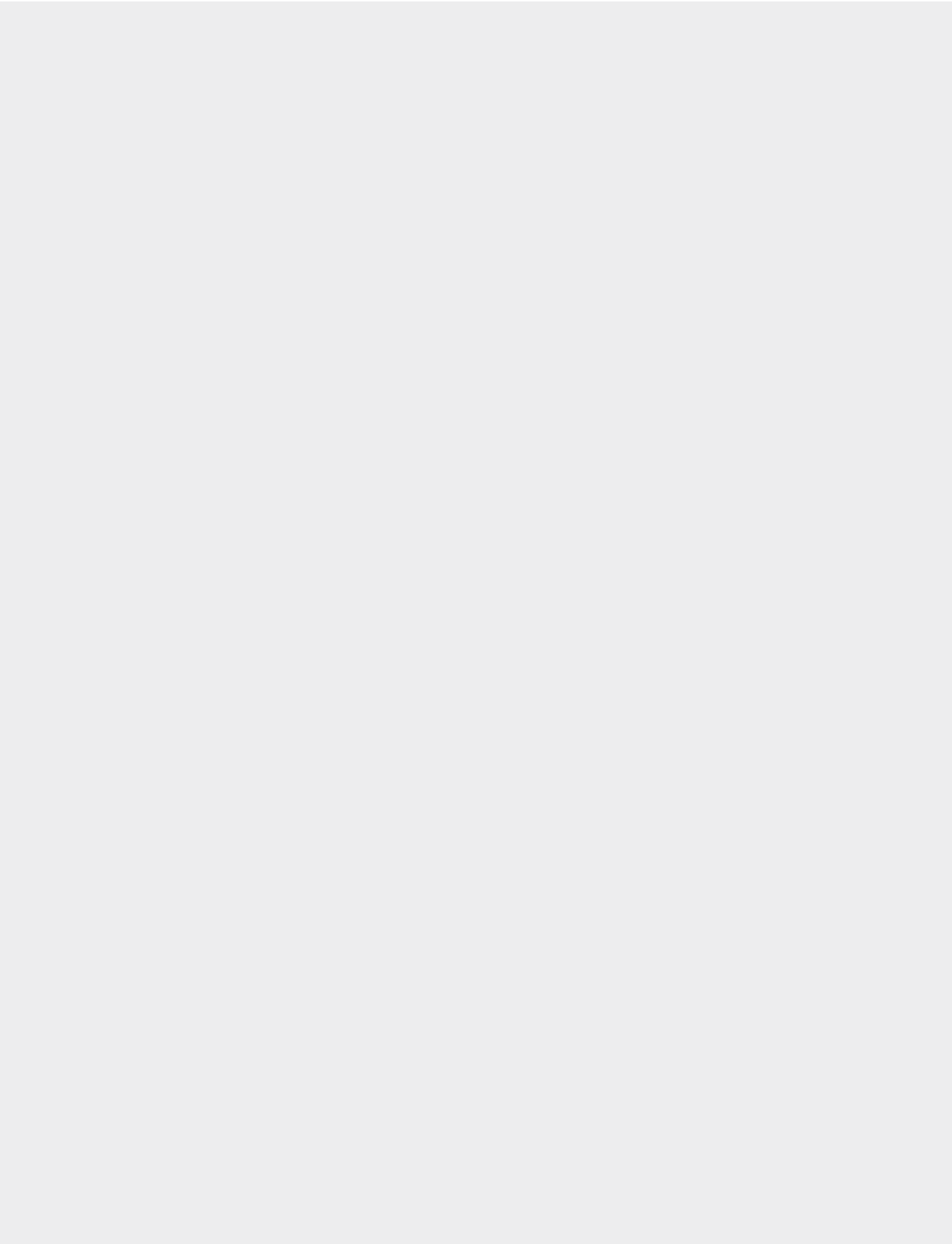

NOTES

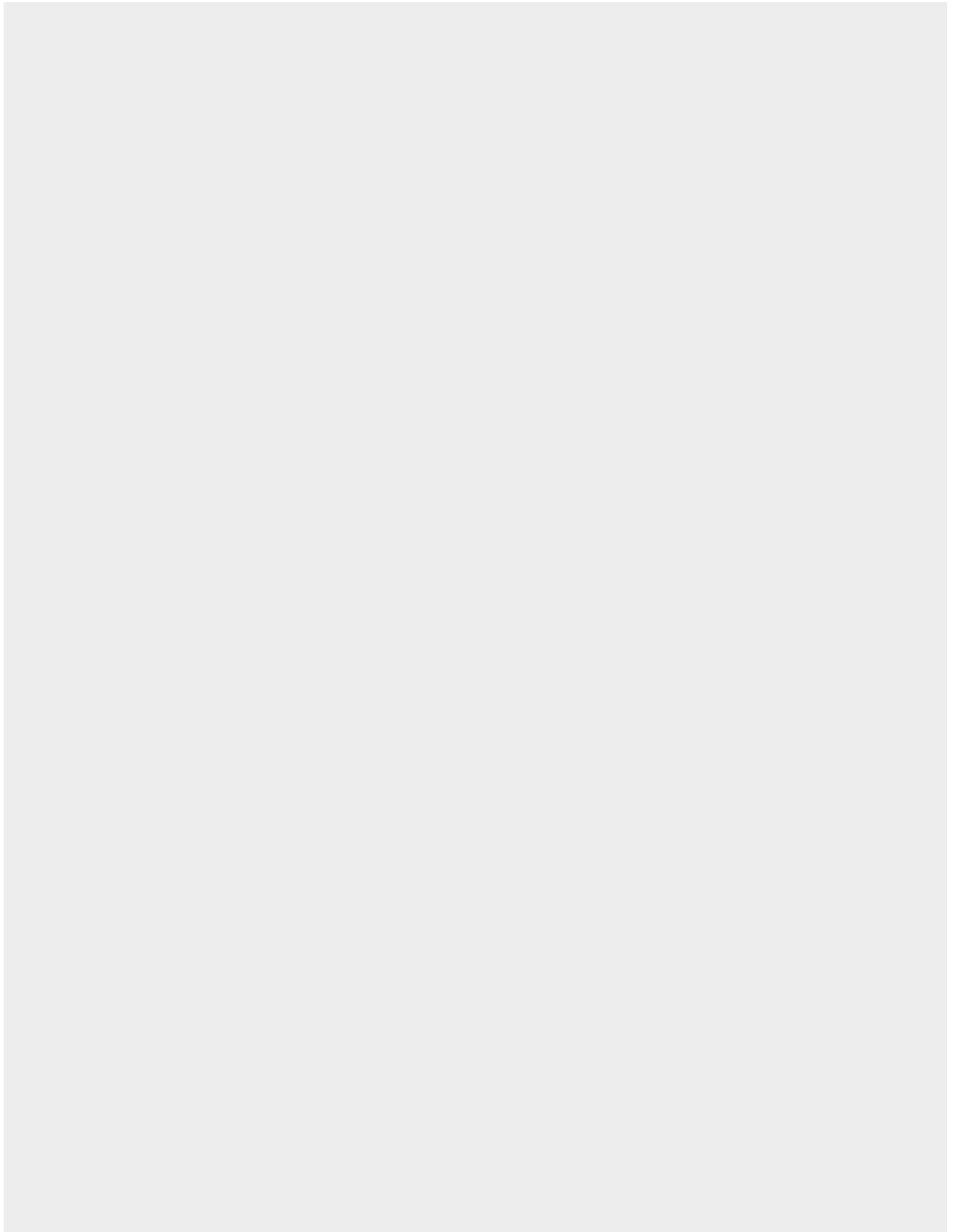



LG Electronics USA, Inc.

Air Conditioning Technologies

4300 North Point Parkway, Alpharetta, GA 30022

www.lghvac.com

©2019 LG Electronics U.S.A. All rights reserved.

Distributed by

Document Number: PB_Single_Multi_DFS_Systems_09_19