

# LG SIGNATURE

## OWNER'S MANUAL WASHING MACHINE

Read this owner's manual thoroughly before operating the appliance and keep it handy for reference at all times.

WM9500H\*A



MFL68005505  
Rev.04\_072016

# TABLE OF CONTENTS

## **3 PRODUCT FEATURES**

---

## **4 SAFETY INSTRUCTIONS**

---

4 IMPORTANT SAFETY INSTRUCTIONS

## **8 PRODUCT OVERVIEW**

---

8 Parts

8 Accessories

## **9 INSTALLATION**

---

9 Installation Overview

10 Product Specifications

11 Choosing the Proper Location

12 Unpacking and Removing Shipping Bolts

13 Connecting the Water Lines

14 Connecting the Drain Hose

15 Leveling the Washer

16 Connecting to the Power Supply

16 Testing the Washer

## **17 OPERATION**

---

17 Using the Washer

18 Sorting Laundry

19 Loading the Washer

19 Adding Cleaning Products

22 Control Panel

23 Wash Cycles

25 Cycle Guide

29 Cycle Modifier Buttons

30 Special Cycles/Features

30 Option Buttons

## **32 SMART FUNCTIONS**

---

32 Smart Appliance Connectivity

35 FCC Notice (For transmitter module contained in this product)

35 FCC RF Radiation Exposure Statement

36 Using Smart Diagnosis™

## **37 MAINTENANCE**

---

37 Regular Cleaning

39 Cleaning the Door Seal

39 Cleaning the Water Inlet Filters

40 Cleaning the Drain Pump Filter

41 Care in Cold Climates

## **42 TROUBLESHOOTING**

---

42 FAQs: Frequently Asked Questions

43 Before Calling for Service

## **50 WARRANTY (USA)**

---



# PRODUCT FEATURES

## INVERTER DIRECT DRIVE MOTOR

The inverter motor, which is directly connected to the tub, produces little noise and vibration and offers great durability and a long lifespan.

## TUB CLEAN

Cleaning of the tub on a regular monthly basis using Tub Clean can help keep the tub clean and fresh.

## LARGE CAPACITY STAINLESS STEEL DRUM

The large capacity stainless steel drum offers extreme durability and is tilted to improve efficiency and allow easier access for large items.

## CHILD LOCK

Use this option to disable the controls during a wash cycle. This option can prevent children from changing cycles or operating the machine.

## DETERGENT DISPENSER

The four-compartment dispenser makes it easy to separate the pre-wash detergent, main laundry detergent, liquid bleach, and fabric softener into different compartments.

## HIGH TEMPERATURE STEAM CYCLES (on some models)

LG's unique, high-temperature steam cycles help to remove tough stains.

## SMART DIAGNOSIS™

Should you experience any technical difficulty with your washer, it has the capability of transmitting data by phone to the Customer Information Center. The call center agent records the data transmitted from your machine and uses it to analyze the issue, providing a fast and effective diagnosis.

# SAFETY INSTRUCTIONS

## ***READ ALL INSTRUCTIONS BEFORE USE***

### **Your safety and the safety of others are very important.**

We have provided many important safety messages in this manual and on your appliance. Always read and follow all safety messages.

This is the safety alert symbol.



This symbol alerts you to potential hazards that can kill or injure you and others.

All safety messages will follow the safety alert symbol and either the word **WARNING** or **CAUTION**.

These words mean:



### **WARNING**

If you do not follow instructions, it could result in death or serious injury.



### **CAUTION**

If you do not follow instructions, it could result in minor or moderate injury or damage to the product.

All safety messages will tell you what the potential hazard is, tell you how to reduce the chance of injury, and tell you what may happen if the instructions are not followed.

## **IMPORTANT SAFETY INSTRUCTIONS**



### **WARNING**

**To reduce the risk of explosion, fire, death, electric shock, scalding or injury to persons when using this product, follow basic precautions, including the following:**

### **California Safe Drinking Water and Toxic Enforcement Act**

- This product contains chemicals known to the state of California to cause cancer and birth defects or other reproductive harm. ***Wash hands after handling.***

### **INSTALLATION**

- Adhere to all industry recommended safety procedures including the use of long sleeved gloves and safety glasses.
- Never attempt to operate this appliance if it is damaged, malfunctioning, partially disassembled, or has missing or broken parts, including a damaged cord or plug.
- Before use, the appliance must be properly installed as described in this manual.
- To reduce the risk of severe injury or death, follow all installation instructions.
- Refer to the **INSTALLATION INSTRUCTIONS** for detailed grounding procedures. Installation instructions are packed with the appliance for the installer's reference. If the appliance is moved to a new location, have it checked and reinstalled by qualified service personnel.
- The appliance must be installed and electrically grounded by qualified service personnel in accordance with local codes.
- Connect to a properly rated, protected, and sized power circuit to avoid electrical overload.
- This appliance must be positioned near to an electrical power supply.

- Disconnect the power cord, house fuse or circuit breaker before installing or servicing the appliance.
- When moving or installing the product in a different location, call qualified service personnel for installation and service.
- The power cord of this appliance is equipped with a 3-prong (grounding) plug which mates with a standard 3-prong (grounding) wall outlet minimize the possibility of electric shock from this appliance.
- Do not, under any circumstances, cut or remove the third (ground) prong from the power cord.
- When installing or moving the appliance, be careful not to pinch, crush, or damage the power cord.
- Do not install the appliance in humid spaces.
- Keep packing materials out of the reach of children. Packaging material can be dangerous for children. There is a risk of suffocation.
- Destroy the carton, plastic bag, and other packing materials after the appliance is unpacked. Children might use them for play. Cartons covered with rugs, bedspreads, or plastic sheets can become airtight chambers.
- Moving or installation of the appliance requires two or more people.
- Store and install the appliance where it will not be exposed to temperatures below freezing or exposed to outdoor weather conditions.
- This appliance is not designed for maritime use or for mobile installations such as in RVs, trailers, or aircraft.

## OPERATION

- Read all instructions before using the appliance and save these instructions.
- Use this appliance only for its intended purpose.
- Do not tamper with controls.
- Do not abuse, sit on, or stand on the door of the appliance.
- Do not allow children to play on, in or with the appliance. Close supervision of children is necessary when the appliance is used near children.
- Do not reach into the washer if the tub or drum, agitator, or any interior parts are moving. Before loading, unloading, or adding items, press Start/Pause and allow the tub or drum to coast to a complete stop before reaching inside.
- Do not mix chlorine bleach with ammonia or acids such as vinegar. Follow package directions when using laundry products. Incorrect usage can produce poisonous gas, resulting in serious injury or death.
- Never use harsh chemicals, abrasive cleaners, or solvents to clean the washer. They will damage the finish.
- Do not use an extension cord or adapter with this appliance.
- Repair or immediately replace all power cords that have become frayed or otherwise damaged. Do not use a cord that shows cracks or abrasion damage along its length or at either end.
- Do not grasp the power cord or touch the appliance controls with wet hands.
- Do not modify or extend the power cord.
- Do not wash articles that have been previously cleaned in, washed in, soaked in, or spotted with gasoline, dry-cleaning solvents, vegetable or cooking oil, or other flammable or explosive substances, as they give off vapors that could ignite or explode.
- In the event of a gas leak (propane gas, LP gas, etc.) do not operate this or any other appliance. Open a window or door to ventilate the area immediately.

- If the product has been submerged, contact an LG Electronics customer information center for instructions before resuming use.
- If you detect a strange sound, a chemical or burning smell, or smoke coming from the appliance, unplug it immediately, and contact an LG Electronics customer information center.
- Keep laundry products out of children's reach. To prevent injury to persons, observe all warnings on product labels.
- Under certain conditions, hydrogen gas may be produced in a hot-water system that has not been used for two weeks or more. **HYDROGEN GAS IS EXPLOSIVE.** If the hot-water system has not been used for such a period, before using the appliance turn on all hot water faucets and let the water flow from each for several minutes. This will release any accumulated hydrogen gas. As the gas is flammable, do not smoke or use an open flame during this time.
- Do not store or use gasoline or other flammable vapors and liquids in the vicinity of this or any other appliance.
- Do not add gasoline, dry cleaning solvents, or other flammable or explosive substances to the wash water. These substances give off vapors that could ignite or explode.
- Do not put oily or greasy clothing, candles or flammable materials on top of the appliance.
- Keep the area underneath and around your appliances free of combustible materials (lint, paper, rags, etc.), gasoline, chemicals and other flammable vapors and liquids.
- This appliance is not intended for use by persons (including children) with reduced physical, sensory or mental capabilities, or lack of experience and knowledge, unless they have been given supervision or instruction concerning the use of the appliance by a person responsible for their safety.
- If the electrical supply cord is damaged, it must only be replaced by the manufacturer or its service agent or a similar qualified person in order to avoid a hazard.
- Never unplug the appliance by pulling on the power cord. Always grip the plug firmly and pull straight out from the outlet.
- Fix the drain hose securely in place.

### **MAINTENANCE**

- Remove the door before the appliance is removed from service or discarded to avoid the danger of children or small animals getting trapped inside.
- Do not repair or replace any part of the appliance. All repairs and servicing must be performed by qualified service personnel unless specifically recommended in this Owner's Manual. Use only authorized factory parts.
- Remove any dust or foreign matter from the power plug pins.
- Disconnect this appliance from the power supply before cleaning and attempting any user maintenance. Turning the controls to the OFF position does not disconnect this appliance from the power supply.
- Make sure the dispenser drawer or lid is closed at all times when not being filled with laundry products.
- Do not disassemble or repair the appliance by yourself.

# **SAVE THESE INSTRUCTIONS**

## GROUNDING INSTRUCTIONS

- Improper connection of the equipment-grounding conductor can result in a risk of electric shock. Check with a qualified electrician or service personnel if you are in doubt whether the appliance is properly grounded. Do not modify the plug provided with the appliance; if it will not fit the outlet, have a proper out-let installed by a qualified electrician.
- For your safety, the information in this manual must be followed to minimize the risk of fire, explosion, or electric shock, or to prevent property damage, injury to persons, or death.
- The appliance must be grounded. In the event of a malfunction or breakdown, grounding will reduce the risk of electric shock by providing a path of least resistance for electric current. The appliance is equipped with a cord having an equipment-grounding conductor and a grounding plug. The plug must be plugged into an appropriate outlet that is installed and grounded in accordance with all local codes and ordinances.

## CAUTION

**To reduce the risk of minor injury to persons, malfunction, or damage to the product or property when using this product, follow basic precautions, including the following:**

### INSTALLATION

- Install the product on a firm and level floor.

### OPERATION

- Turn off the water faucets and unplug the appliance if the appliance is to be left for an extended period of time, such as during vacations.
- Do not place objects on top of the appliance.
- Do not touch draining water which may be hot.
- If the drain hose and the water supply hose are frozen in winter, defrost before using the appliance.
- ALWAYS follow the fabric care instructions supplied by the garment manufacturer.
- Use fabric softeners or products to eliminate static only as recommended by the manufacturer.
- Do not combine laundry products for use in one load unless specified on the label.
- Do not store or spill liquid detergents, cleaners, or bleaches (chlorine bleach, oxygen bleach) on the appliance. Doing so may result in corrosion, discoloration or damage to the surface of the appliance.

# PRODUCT OVERVIEW

## Parts

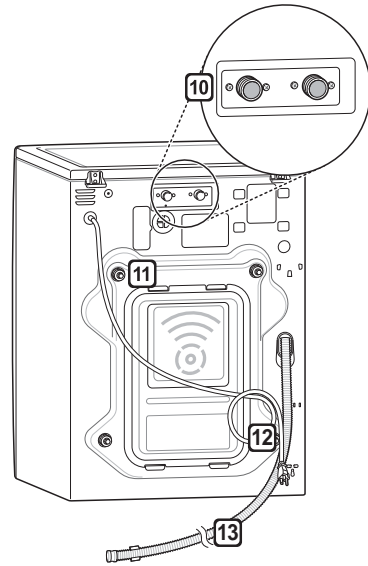
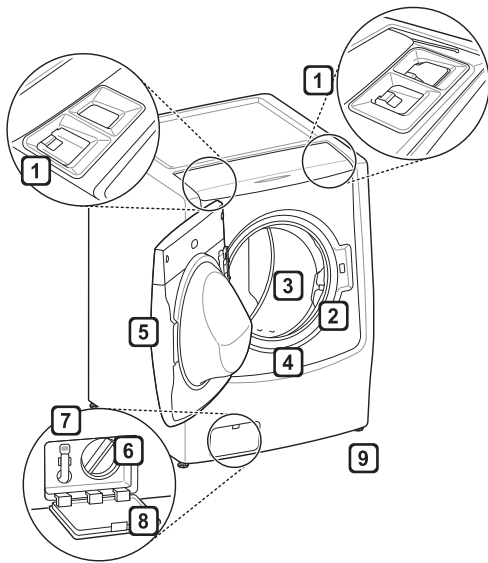

**1** Detergent dispenser

**4** Door seal

**7** Pump drain hose

**10** Water inlets

**2** Water circulation nozzles

**5** Door

**8** Drain pump filter cover

**11** Shipping bolts

**3** Tub

**6** Drain pump filter

**9** Leveling feet

**12** Power cord

**13** Drain hose

## Accessories

### Included Accessories



Non-skid pads

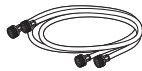

Hot/cold water hoses



Caps for covering shipping bolt holes



Wrench



Tie strap



Elbow bracket  
(for securing drain hose)

### Optional Accessories

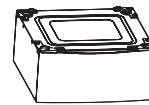

Pedestal or Pedestal washer  
(sold separately)

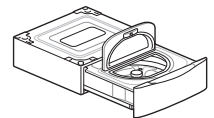

### NOTE

- The images in this guide may be different from the actual components and accessories, which are subject to change by the manufacturer without prior notice for product improvement purposes.
- For your safety and for extended product life, use only authorized components. The manufacturer is not responsible for product malfunction or accidents caused by the use of separately purchased unauthorized components or parts.

# INSTALLATION

## Installation Overview

Please read the following installation instructions first after purchasing this product or transporting it to another location.

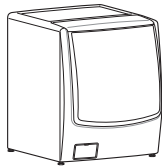

Choosing the proper location

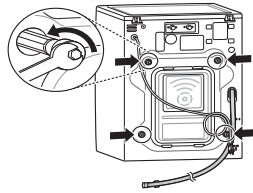

Unpacking and removing shipping bolts

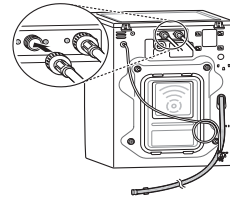

Connecting the water line

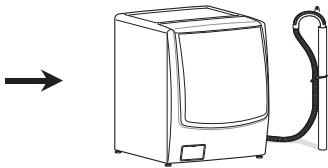

Connecting the drain line

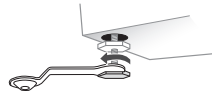

Leveling the washer

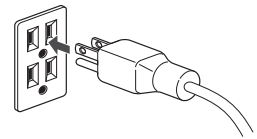

Connecting to the power supply

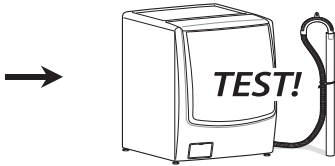

Testing the washer

### **⚠ WARNING**

- Moving or installation of the appliance requires two or more people. Failure to follow these instructions may result in injury.
- Store and install the appliance where it will not be exposed to temperatures below freezing or exposed to outdoor weather conditions. Failure to follow this warning can cause product or part failure, serious injury, fire, electric shock, or death.
- Properly ground the washer to conform with all governing codes and ordinances. Failure to follow this warning can cause serious injury, fire, electric shock, or death.
- To reduce the risk of electric shock, do not install the appliance in humid spaces. Failure to follow this warning can cause serious injury, fire, electric shock, or death.
- To ensure proper air flow, do not block the large opening on the bottom of the washer with carpeting or other materials.
- Do not remove the ground prong. Do not use an adapter or extension cord. Plug into a grounded 3-prong outlet. Failure to follow this warning can cause serious injury, fire, electric shock, or death.

## Product Specifications

The appearance and specifications listed in this manual may vary due to constant product improvements.

Model WM9500H*A	
Electrical requirements	120 VAC @ 60 Hz
Min. / Max. water pressure	20 – 120 psi (138–827 kPa)
Dimensions	75.2 cm (W) X 86.4 cm (D) X 104.5 (H), 143 cm (D with door open) 29 5/8" (W) X 34 1/16" (D) X 41 3/16" (H), 56 5/16" (D with door open)
Net weight	239 lb (108kg)
Max spin speed	1300 RPM

### Tools Required for Installation

- Adjustable Pliers

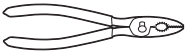

- Carpenter's Level





## Choosing the Proper Location

Install the washer on a solid floor that is strong and rigid enough to support the weight of the washer, even when fully loaded, without flexing or bouncing. If the floor has too much flex, you may need to reinforce it to make it more rigid. If the floor is not solid, it may cause severe vibration and noise.

### NOTE

- Before installing the washer, make sure the floor is clean, dry and free of dust, dirt, water and oil so the washer feet cannot slide easily. Leveling feet that can move or slide on the floor can contribute to excess vibration and noise due to poor contact with the floor.
- If a drip pan must be used, take extra care to follow the instructions provided with the drip pan and make sure the leveling feet are adjusted for firm and even contact with the pan. Use of drip pans and failure to properly level the machine may result in increased vibration and noise during operation.
- Allow for sufficient space between the walls and the washer for installation.

## Power Outlet

- The power outlet must be within 60 inches (1.5 m) of either side of the washer.
- The appliance and outlet must be positioned so that the plug is easily accessible.
- Do not overload the outlet with more than one appliance.
- The outlet must be grounded in accordance with current wiring electric codes and regulations.
- Use a time-delay fuse or circuit breaker.

### NOTE

- It is the personal responsibility and obligation of the product owner to have a proper outlet installed by qualified service personnel.

## Flooring

- To minimize noise and vibration, the washer must be installed on a solidly constructed floor.
- Allowable slope under the entire washer is a maximum 1 inches difference from side to side or from front to back.
- Installing on carpeting and soft tile surfaces is not recommended.

- Never install the washer on a platform or weakly supported structure.

### NOTE

- The washer must be installed on firm flooring to minimize vibration during the spin cycle. Concrete flooring is best, but a wood floor is sufficient, provided it is built to FHA standards.

## Floor Installation

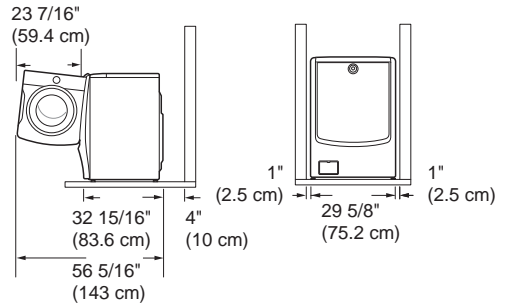

To ensure sufficient clearance for water lines, the drain line and airflow, allow minimum clearances of at least 1 inches (2.5 cm) at the sides and 4 inches (10 cm) behind the unit. Be sure to allow for wall, door, or floor moldings that may increase the required clearances.

### NOTE

- Do not use a drip pan as it can block the drawer. Using the drip pan may result in increased vibration and noise during operation.

## Pedestal Washer Installation

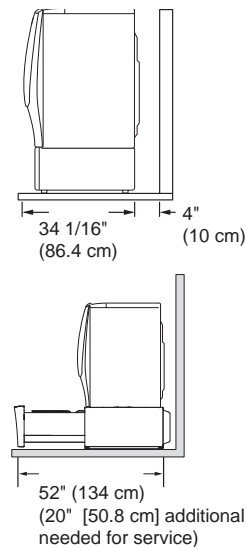

### NOTE

- Refer to the instructions packaged with the optional pedestal kit before installing with a pedestal kit.

## Unpacking and Removing Shipping Bolts

### 1 Lift the washer off the foam base.

After removing the carton and shipping material, lift the washer off the foam base. Make sure the plastic tub support comes off with the base and is not stuck to the bottom of the washer.

If you must lay the washer down to remove the base packaging materials, always protect the side of the washer and lay it carefully on its side. Do not lay the washer on its front or back.

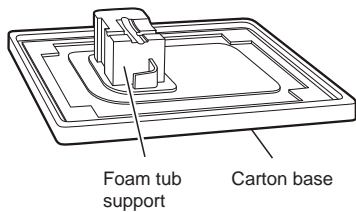

### 2 Remove the bolt assemblies.

Starting with the bottom two shipping bolts, use the wrench (included) to fully loosen all four shipping bolts by turning them counterclockwise. Remove the bolt assemblies by wiggling them slightly while pulling them out.

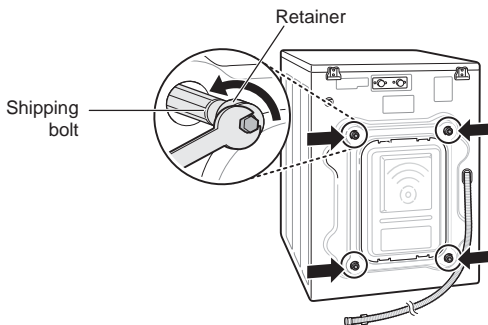

### 3 Install the hole caps.

Locate the four hole caps included in the accessory pack and install them in the shipping bolt holes.

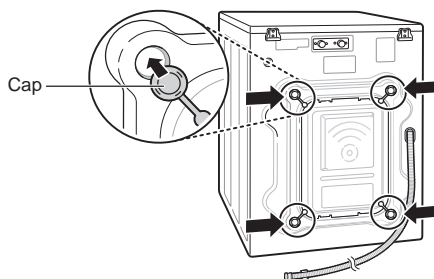

### NOTE

- Save the bolt assemblies for future use. To prevent damage to internal components, do not transport the washer without reinstalling the shipping bolts.
- Failure to remove shipping bolts and retainers may cause severe vibration and noise, which can lead to permanent damage to the washer. The cord is secured to the back of the washer with a shipping bolt to help prevent operation with shipping bolts in place.

# Connecting the Water Lines

## 1 Check the fittings and seals.

Inspect the threaded fitting on each hose and make sure there is a rubber seal in place in both ends of each hose to prevent leaking.

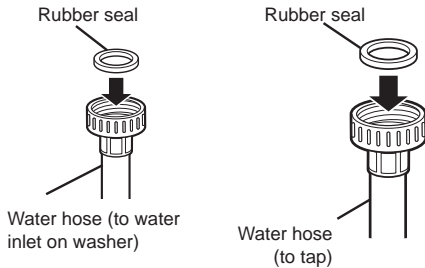

## 2 Connect the water supply hoses.

Connect the water supply hoses to the hot and cold water faucets tightly by hand and then tighten another 2/3 turn with pliers. Connect the blue hose to a cold water faucet and the red hose to a hot water faucet.

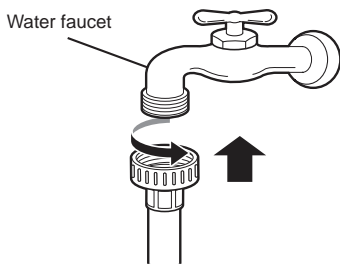

## 3 Flush out the inlet hoses.

After connecting the inlet hoses to the water faucets, turn on the water faucets to flush out foreign substances (dirt, sand or sawdust) in the water lines. Let water drain into a bucket, and check the water temperature to make sure you've connected the hoses to the correct faucets.

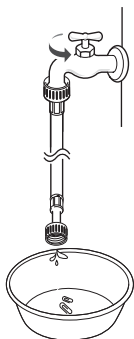

## 4 Attach the water lines to the back of the washer.

Attach the hot water line to the hot water inlet on the back of the washer. Attach the cold water line to the cold water inlet on the back of the washer. Tighten the fittings securely. Turn ON both faucets all the way and check for leaks at both ends of the hoses.

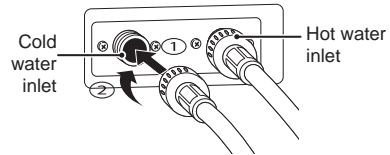

### ! WARNING

- Do not overtighten the hoses or crossthread the hose fittings. Overtightening or cross-threading can damage the valves, resulting in leaking and property damage.
- Do not overtighten. Damage to the coupling can result.

### ! CAUTION

- Do not reuse old hoses. Use only new hoses when installing the washer. Old hoses could leak or burst causing flooding and property damage. Contact LG Customer Service for assistance in buying hoses: 1-800-984-6306.

### NOTE

- Periodically check the hoses for cracks, leaks, and wear, and replace the hoses every five years. Do not stretch the water hoses intentionally, and make sure that they are not pinched, crushed or kinked by other objects.
- Water supply pressure must be between 20 psi and 120 psi (138 – 827 kPa). If the water supply pressure is more than 120 psi, a pressure reducing valve must be installed.
- To provide optimum washing performance, the hot water temperature should be set at 120 – 135 °F (48 – 57 °C) and the cold at 60 °F (15 °C).
- The washer should never be installed or stored in a location subject to freezing temperatures. Damage to the water lines and internal mechanisms of the washer can result. If the washer was exposed to freezing temperatures prior to installation, allow it to stand at room temperature for several hours before use and check for leaks prior to operation.

## Connecting the Drain Hose

### NOTE

- The drain hose should always be properly secured. Failure to properly secure the drain hose can result in flooding and property damage.
- The drain must be installed in accordance with any applicable local codes and regulations.
- Make sure that the drain hose is not stretched, pinched, crushed, or kinked.
- Do not install the drain hose with the end lower than 29.5 inches (0.7 m) or higher than 96 inches (2.4 m) above the bottom of the washer or more than 60 inches (1.5 m) away from the washer.
- Never create an airtight seal between the hose and the drain with tape or other means. If no air gap is present, water can be siphoned out of the tub resulting in poor wash/rinse performance or clothing damage.

### Option 1: Standpipe

#### 1 Clip the end of the hose into the elbow bracket.

Connect the elbow bracket within 4 inches (10 cm) of the end of the drain hose. If the drain hose is extended more than 4 inches (10 cm) beyond the end of the elbow bracket, mold or microorganisms could spread to the inside of the washer.

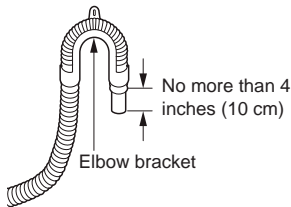

#### 2 Insert the end of the drain hose into the standpipe.

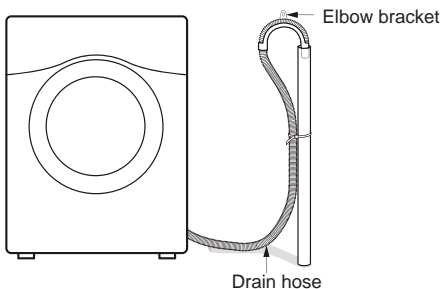

#### 3 Use a tie strap to secure the drain hose in place.

### Option 2: Laundry Tub

#### 1 Clip the end of the hose into the elbow bracket.

Connect the elbow bracket within 4 inches (10 cm) of the end of the drain hose. If the drain hose is extended more than 4 inches (10 cm) beyond the end of the elbow bracket, mold or microorganisms could spread to the inside of the washer.

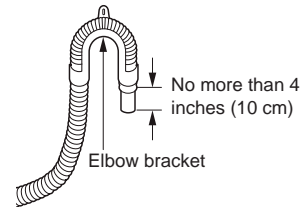

#### 2 Hang the end of the drain hose over the side of the laundry tub.

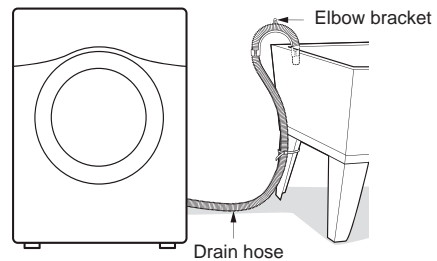

#### 3 Use a tie strap to secure the drain hose in place.

## Leveling the Washer

The drum of your new washer spins at very high speeds. To minimize vibration, noise, and unwanted movement, the floor must be a level, solid surface. The slope beneath the washer should not exceed 1 inch, and all four leveling feet must rest firmly on the floor.

### NOTE

- Adjust the leveling feet only as far as necessary to level the washer. Extending the leveling feet more than necessary can cause the washer to vibrate
- Before installing the washer, make sure that the floor is clean, dry and free of dust, dirt, water and oil so the washer feet cannot slide easily. Feet that move or slide on the floor can contribute to excessive vibration and noise due to poor contact with the floor.

### 1 Position the washer in its final location.

Take special care not to pinch, strain, or crush the water and drain lines. If you have a carpenter's level, you can place it across the top of the washer.

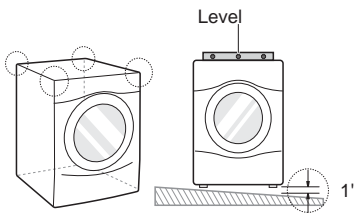

### 2 Adjust the lower leveling feet.

Turn in one direction to raise the washer or the other direction to lower it.

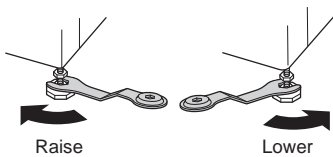

### 3 Tighten the locknuts.

Turn the locknuts counterclockwise and tighten them when the washer is level.

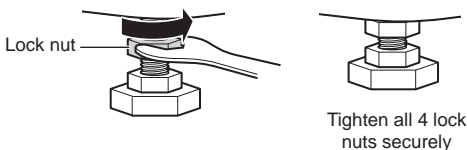

### 4 Recheck the washer's levelness.

Push or rock the top edges of the washer gently to make sure the washer does not rock. If the washer rocks, repeat steps 1-3.

### CAUTION

- Using the washer without leveling it may cause excess vibration and noise, leading to a machine malfunction.
- Extend the leveling feet only to level the washer. If you extend the leveling feet unnecessarily, it may cause abnormal vibration of the washer.

## Using Non-Skid Pads

If you install the washer on a slippery surface, it may move because of excessive vibration. Incorrect leveling may cause malfunction through noise and vibration. If this occurs, install the non-skid pads under the leveling feet and adjust the level.

### 1 Clean the floor to attach the non-skid pads.

Use a dry rag to remove and clean foreign objects or moisture. If moisture remains, the non-skid pads may slip.

### 2 Adjust the level after placing the washer in the installation area.

### 3 Place the adhesive side of the non-skid pad on the floor.

It is most effective to install the non-skid pads under the front legs. If it is hard to place the pads under the front legs, place them under the back legs.

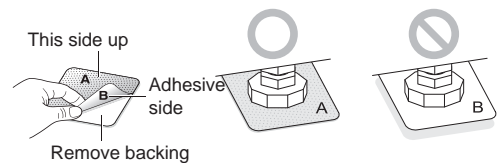

### 4 Recheck the washer's levelness.

Push or rock the top edges of the washer gently to make sure that the washer does not rock. If the washer rocks, level the washer again.

## Connecting to the Power Supply

The washer should be plugged into a 120-VAC, 60 Hz grounded 3-prong outlet. Plug in the washer.

### **!** WARNING

- Do not use a worn or damaged power cord or power plug. Replace or repair it immediately. Failure to do so may result in death, fire, electric shock, or malfunction.
- Do not modify the power cord and plug provided with the appliance. Take care not to damage it when installing or moving the washer. Failure to do so may result in death, fire, electric shock, or malfunction.
- Make sure that the washer is grounded.
- Connect this washer to a grounded outlet conforming to the rating prior to use. Failure to do so may result in fire, electric shock, or malfunction.
- Do not damage or cut off the ground prong of the power cord. Doing so may cause death, fire, electric shock, or product malfunction.
- Improper connection of the equipment-grounding conductor can result in risk of electric shock. Check with a qualified electrician or service technician if you are in doubt as to whether the appliance is properly grounded. If it does not fit the outlet, have a proper outlet installed by a qualified electrician
- The appliance and outlet must be positioned so that the plug is easily accessible.
- Do not use adapters or extension cords. Doing so may result in serious injury, fire, electric shock, or death.
- For best performance, plug the washer into its own individual outlet. This helps prevent overloading house wiring circuits which could cause a fire hazard from overheated wires.
- If necessary, use a new, UL-listed 3-prong adapter or 3-wire extension cord with a 3-prong (grounding) plug rated at no less than the branch circuit. Do not use an extension cord longer than 3 feet. Failure to follow these warnings may result in serious injury, fire, electric shock, or death.

## Testing the Washer

Check if the washer is properly installed and run a test cycle.

- 1 Load the washer with 6 pounds of laundry (approximately 6 thick bath towels).
- 2 Press the **Power** button.
- 3 Select the **Rinse+Spin**.
- 4 Press the **Start/Pause** button.  
The wash cycle starts.
- 5 Check if water is supplied, that the machine does not rock or vibrate excessively, and that it drains well during the spin cycle.

### NOTE

- If water leaks during water supply, see Connect the Water Lines to connect them properly.
- If the washer rocks and vibrates excessively, see Level the Washer to level it again.
- If the drain does not work, see Connect the Drain Hose to install the hose properly.

### **!** CAUTION

- Be careful not to catch hands when opening or closing the door.

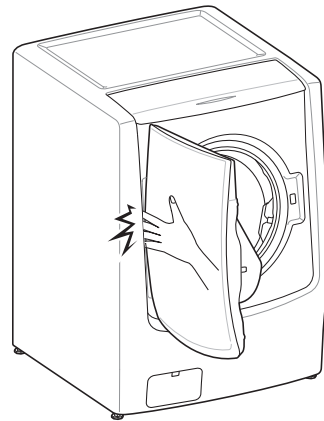

# OPERATION

## Using the Washer

### WARNING

- To reduce the risk of fire, electric shock, or injury to persons, read the SAFETY INSTRUCTIONS before operating this appliance.

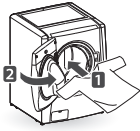

#### 1 Sort Laundry and Load the Washer

Sort laundry by fabric type, soil level, color and load size, as needed. Open the door and load items into the washer.

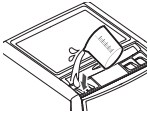

#### 2 Cleaning Products

Add the proper amount of HE (High-Efficiency) detergent to the detergent dispenser. If desired, add bleach or fabric softener to the appropriate dispensers.



#### 3 Turn on the Washer

Press the **Power** button to turn on the washer. The lights above the cycle buttons will illuminate and a chime will sound.



#### 4 Cycle Buttons

Press the Cycle button until the desired cycle is selected.



#### 5 Adjust Settings

Default settings for the selected cycle can now be changed, if desired, using the cycle modifier and option buttons.

#### NOTE

- Not all modifiers and options are available on all cycles. A different chime will sound and the LED will not come on if the selection is not allowed.



#### 6 Begin Cycle

Press the **Start/Pause** button to begin the cycle. The washer will agitate briefly without water to measure the weight of the load. If the **Start/Pause** button is not pressed within 60 minutes, the washer will shut off and all settings will be lost.



#### 7 End of Cycle

When the cycle is finished, a melody will sound. Immediately remove your clothing from the washer to reduce wrinkling. Check around the door seal when removing the load for small items that may be caught in the seal.

#### NOTE

- The washer rotates the laundry in a way that allows it to use less water while still fully saturating your clothing. It is normal to not be able to see water during the wash cycle. If the temperature or the water level inside the machine is too high, the door locks and cannot be opened. To open the door while washing, use the Rinse+Spin feature.



## Sorting Laundry

### CAUTION

- The washer can be fully loaded, but the drum should not be tightly packed with items. The door of the washer should close easily.
- Use the Jumbo Wash/Bedding cycle for buoyant or nonabsorbent items such as pillows or comforters. Failure to follow this caution can result in leakage.
- If possible, do not wash any water-resistant items. If you must, please select the Jumbo Wash/Bedding cycle.

## Grouping Similar Items

For the best washing results, and to reduce the possibility of damage to clothing, care should be taken to sort the clothing into loads that are made up of similar items.

Mixing different fabric types and/or soil levels can result in poor wash performance, color transfer, discoloration, fabric damage or linting. Fabrics should be sorted into groups as described below.

### Colors

Sort articles by color. Wash dark clothes together in a separate load from light colors or whites. Mixing dark clothes with light clothes can result in dye transfer or discoloration of the lighter clothes.

### Soil Level

Wash heavily soiled clothing together. Washing lightly soiled clothing in the same load with heavily soiled clothing could result in poor wash performance for the lightly soiled clothing.

### Fabric Type

Delicate articles should not be mixed with heavy or sturdy fabric types. Washing heavy fabrics in a delicate load can result in poor wash performance for the heavy fabrics and possible damage to the delicates.

### Lint Type











Some fabrics attract and bind lint to them while others give off lint in the laundry process. Avoid mixing these lint collectors and lint producers in the same load. Mixing these fabrics will result in pilling and linting on the lint collectors. (For example, lint collector—knit sweater; lint producer—terry cloth towels.)

## Sort Laundry

By colors	By Soil	By Fabric	By Lint
White	Heavy	Delicates	Lint Producer
Lights	Normal	Easy Care	Lint Collector
Darks	Light	Sturdy	

## Fabric Care Labels

Many articles of clothing include a fabric care label. Using the chart below, adjust the cycle and option selections to care for your clothing according to the manufacturer's recommendations.

Category	Label	Directions
Washing		Hand wash
		Machine wash, Normal cycle
		Perm Press/Wrinkle Resistant setting (which has a cool down or cold spray before the slower spin)
		
		Gentle/Delicate setting (slow agitation and/or reduced wash time)
		Do not wash
Water Temperature		Do not wring
	...	Hot
	..	Warm
Bleach Symbols	.	Cold/Cool
		Any bleach (when needed)
		Only non-chlorine bleach (when needed)
		Do not bleach



## Loading the Washer

- Check and empty pockets. Paper clips, coins, matches, etc. can damage clothing and the washer.
- Close zippers and hooks, and tie drawstrings to prevent snagging or tangling of clothes.
- Pretreat heavily stained areas for best results.
- Combine large and small items in a load. Load large items first. Large items should not be more than half of total load.
- The washer can be fully loaded, but the drum should not be tightly packed with items. The door of the washer must close easily.
- Do not wash single small items. Add 1-2 similar items to the load to prevent an out-of-balance load.
- Wash thick, bulky items individually. Heavy blankets, comforters, bedspreads, or pet beds can get tangled or cause an unbalanced load if combined with other items.
- Do not wash/spin waterproof items. Washing raincoats or sleeping bags may result in abnormal vibration or may cause the load to bounce, which could damage the drum.
- Wash small, light items in a mesh bag. Items like underwear can get caught in the door seal, and a brassiere hook may damage other items or the drum.
- Brush off heavy soil, dust, and hair from items before washing. Excess dirt or sand can abrade other fabrics and lead to poor wash performance.
- For best performance, load clothes as shown.

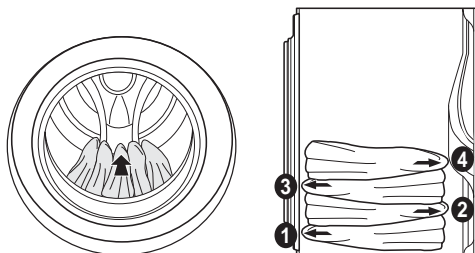

- Load clothes loosely, and do not overfill the drum. Clothes need room to circulate in order to get clean.
- Do not press down on items while stacking them in the drum.

## Adding Cleaning Products

### Loading the Dispenser

To add detergent, bleach, and fabric softener to the automatic dispenser.

#### 1 Open the dispenser lid.

- Push the front handle to slide the lid open.

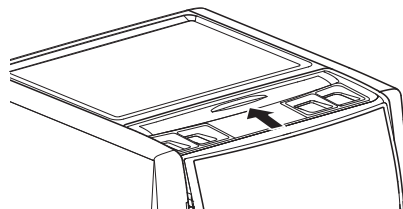

#### 2 Load the laundry products into the appropriate compartments.

- If using a liquid detergent, make sure the liquid detergent cup is in place.
- If using a powdered detergent, remove the liquid detergent cup and put the powder in the main wash detergent compartment.

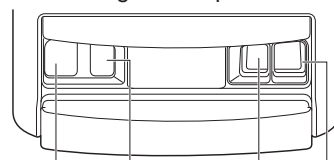

Main wash detergent compartment    Pre-wash detergent compartment    Liquid chlorine bleach compartment    Liquid fabric softener compartment

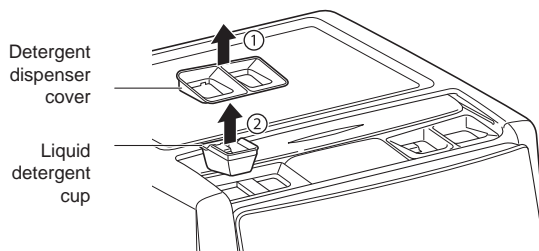

#### 3 Close the lid completely before starting the cycle.

- Be careful not to catch a hand in the lid while closing.

### NOTE

- It is normal for a small amount of water to remain in the dispenser compartments at the end of the cycle.

**IMPORTANT:**

- Do not place or store laundry products, such as detergent, bleach, or liquid fabric softener, on top of your washer or dryer. Wipe up any spills immediately. These products can damage the machine's finish and controls.

**CAUTION**

- To avoid injury, do not place fingers under the lid or between the lid and the cabinet when pressing or sliding the detergent dispenser lid open or closed.

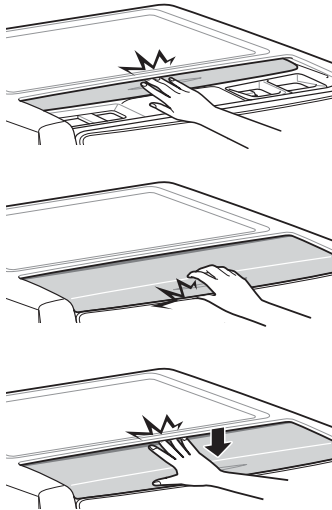
**Pre-Wash Detergent Compartment**

Add liquid or powdered detergent to this compartment when using the Pre-Wash option. Always use HE (High-Efficiency) detergent with your washer.

- When using the Pre-Wash option, liquid detergent for the main wash needs to be loaded in the liquid detergent cup accessory in the main wash dispenser, to prevent it from being dispensed with the pre-wash detergent.
- The amount of detergent added for the Pre-Wash option is 1/2 the amount recommended for the main wash cycle. For example, if the main wash cycle requires one measure of detergent, add 1/2 measure for the Pre-Wash option.

**Main Wash Detergent Compartment**

This compartment holds laundry detergent for the main wash cycle. Either powdered or liquid detergent may be used in this compartment. The detergent is added to the load at the beginning of the cycle. Always use HE (High-Efficiency) detergent with your washer.

**NOTE**

- Never exceed the manufacturer's recommendations when adding detergent. Using too much detergent can result in detergent buildup in clothing and the washer.
- Liquid or powdered color-safe bleach may be added to the main wash compartment with detergent of the same type.
- When using liquid detergent, make sure the liquid detergent cup and insert are in place. Do not exceed the maximum fill line.
- When using powdered detergent, remove the insert and liquid detergent cup from the compartment. Powdered detergent will not dispense with the liquid detergent cup and insert in place.
- If you use a detergent that does not dissolve easily or a detergent with high viscosity, it will leave a residue and clog on the dispenser.

**Liquid Bleach Compartment**

This compartment holds liquid bleach, which is dispensed automatically at the proper time during the wash cycle. The dispenser is activated twice to ensure complete dispensing of the bleach. Any liquid remaining in the dispenser at the end of the cycle is water, not bleach.

- Do not add powdered bleach to this compartment. The bleach compartment is designed to dispense liquid bleach only. Powdered or liquid color-safe bleach will not dispense properly.
- Always follow the manufacturer's recommendations when adding bleach. Never add more than one cup and do not exceed the maximum fill line since this can cause the bleach to be dispensed immediately, resulting in damage to fabrics. Using too much bleach can damage fabrics.
- Never pour undiluted liquid chlorine bleach directly onto the load or into the drum. Fabric damage can occur.
- Do not use color-safe bleach or Oxi products in the same cycle with liquid chlorine bleach.

**WARNING**

- Do NOT mix chlorine bleach with ammonia or acids such as vinegar or rust/scale remover. Mixing chemicals like these can produce a lethal gas, resulting in severe injury or death.

## Fabric Softener Compartment

This compartment holds liquid fabric softener, which is automatically dispensed during the final rinse cycle. Do not exceed the manufacturer's recommendations when adding softener. Using too much fabric softener can result in buildup in clothing and the washer. Either powdered or liquid fabric softener may be used.

- Follow the manufacturer's recommendations when adding fabric softener. Do not exceed the maximum fill line. Using too much fabric softener may stain clothes.
- Dilute concentrated fabric softeners with warm water. Do not exceed the maximum fill line.
- Never pour fabric softener directly onto the load or into the drum.

## Detergent Use

This washer is designed for use with only HE (High-Efficiency) detergents. HE detergents produce fewer suds, dissolve more efficiently to improve washing and rinsing performance, and help to keep the interior of the washer clean. Using detergent that is not HE may cause oversudsing and unsatisfactory performance which could result in error codes, cycle failure, and machine damage.



**Designed specially to use only HE (High-Efficiency) detergent**

- For proper wash performance, always measure detergent using the measuring device provided by the detergent manufacturer. For an average load, use less than half of the recommended maximum. Use less detergent for soft water, light soil, or smaller loads.
- Never use more than the maximum amount of detergent recommended by the manufacturer. Using too much detergent can lead to oversudsing, poor rinsing, detergent buildup in clothing, and residue buildup that can contribute to odors in the machine.
- Use extra care when measuring 2X and 3X concentrated detergents because even a small amount extra can lead to problems.
- Detergents designated as HE-compatible may not provide optimal results.

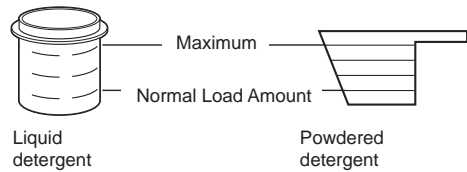

## Control Panel

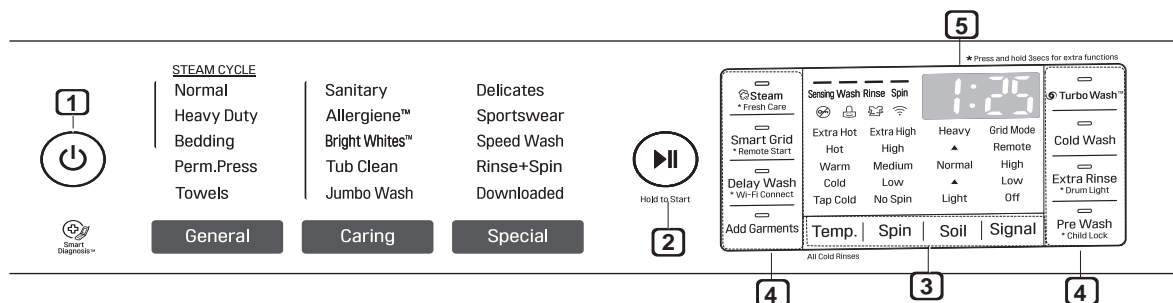

## Control Panel Features

### 1 Power On/Off Button

Press to turn the washer on. Press again to turn the washer off. Pressing the **Power** button during a cycle will cancel that cycle and any load settings will be lost. The door will unlock after a brief pause.

### 2 Start/Pause Button

Press this button to start the selected cycle. If the washer is running, use this button to pause the cycle without losing the current settings.

#### NOTE

- If Start/Pause is not pressed within 60 minutes of selecting a cycle, the washer automatically turns off and all cycle settings are lost.

### 3 Cycle Modifier Buttons

Use these buttons to adjust the water temperature, spin speed and soil level settings for the selected cycle. The current settings are shown in the display. Press the button for that option to select other settings.

### 4 Special Cycle and Option Buttons

These buttons allow you to select special cycles or additional cycle options. Certain buttons also allow you to activate special functions by pressing and holding the button for three seconds.

### 5 Time and Status Display

The display shows the settings, estimated time remaining, options, and status messages for your washer. When the washer is turned on, the default settings in the display will illuminate.

### Door Lock Indicator

The Door Lock indicator will light up once a cycle has started. The indicator light will stay on until the cycle is paused, stopped or has finished.

### Child Lock Indicator

When the Child Lock function is activated, a  message and the remaining wash time are displayed, in turn, on the display panel of the washer. When the Child Lock function is set, all controls are disabled except for the Power button.

### Cycle Status Indicator Sensing Wash Rinse Spin

These LEDs will illuminate when a cycle is selected to indicate which stages will run. When a cycle is running, the LED for the active stage will blink, and the LEDs for the remaining stages will remain steady. Once a stage is complete, the LED will turn off. If a cycle is paused, the active stage LED will stop blinking.

### Estimated Time Remaining

When a cycle is selected, the default time for that cycle is displayed. This time will change as modifiers or options are selected. Once the **Start/Pause** button is pressed, the washer will measure the size of the load. The estimated time may change once the load size has been measured. If Delay Wash is set, the remaining delay time counts down until the cycle begins.

#### NOTE

- The time shown is only an estimate. This time is based on normal operating conditions. Several external factors (load size, room temperature, incoming water temperature, etc.) can affect the actual time.

## Wash Cycles

Wash cycles are designed for the best wash performance for each type of load. Select the cycle that best matches the load contents for maximum wash performance and fabric care. For best results, follow the fabric care labels on your garments. For a guide to the symbols used on fabric care labels.

Press the button to select the desired cycle. When you select a wash cycle, the light for the corresponding wash cycle will turn on.

### NOTE

- Whenever load weights are mentioned, assume 1 lb (0.45 kg) = 1 thick bath towel (dry).
- For information on using SmartThinQ™ applications to save energy, see the Smart Appliance Connectivity section.

Choosing by	Wash Cycle	Description
Fabric Type	Normal	Use this cycle to wash all normal items, except delicate fabrics such as wool or silk. <b>NOTE:</b> Pressing the Start/Pause button without selecting a cycle will cause the Normal cycle to begin immediately, using the default settings.
	Bright Whites™	This cycle is for washing white items only.
	Delicates	This cycle is for washing lingerie or sheer and lacy clothes which can easily be damaged.
	Perm.Press	Use this cycle to wash wrinkle-free clothes or tablecloths, to minimize wrinkles.
	Towels	Use this cycle for washing towels, shirts, jeans and mixed loads.
	Sportswear	Use this cycle for garments that are specially designed and treated for sport.
Load Size	Normal	If you have a mixed load that is half-size, use the Normal cycle with default settings. For full-size loads, use the Normal cycle with the soil level set to heavy, and add an extra rinse. In both cases, the machine will automatically detect the load size and adjust accordingly.
	Speed Wash	Use the Speed Wash cycle to quickly wash lightly soiled clothing and small loads. For high wash and rinse efficiency, wash small loads of 2-3 lightly-soiled garments. <b>NOTE:</b> Use very little detergent in this cycle. For additional, add an extra rinse using the Extra Rinse button.
	Bedding	This cycle is for washing king or queen sized comforters. <b>NOTE:</b> Using the Bedding cycle with a low spin speed is recommended when washing waterproof or water-resistant items, to help protect the fabrics' properties. If your washer does not function properly, manually redistribute the load or put one comforter in at a time.
	Jumbo Wash	This cycle is for washing blankets or bulky items. <b>NOTE:</b> If your washer does not function properly, manually redistribute the load or put one blanket in at a time.

Choosing by	Wash Cycle	Description
Convenience	Speed Wash	Use the Speed Wash cycle to quickly wash lightly soiled clothing and small loads. For high wash and rinse efficiency, wash small loads of 2-3 lightly soiled garments.  <b>NOTE:</b> Use very little detergent in this cycle. For additional, add an extra rinse using the Extra Rinse button.
	Rinse+Spin	Select this option to rinse and spin a load separately from a regular cycle. This can be helpful in preventing fresh stains from setting in fabrics. You can change spin speed by pressing Spin repeatedly until the desired speed is selected.
	Tub Clean	Use this cycle to clean the drum of your washer. See the Tub Clean Cycle in the maintenance section.
	Downloaded	If you download a cycle using the Tag On function, it will be placed in the Downloaded cycle position. Choose the Downloaded cycle to run the downloaded cycle.  <b>NOTE:</b> The default cycle for this position is small load, used for normally soiled loads with just a few items. The small load cycle is also available for download.
Soil Level	Normal	For tough stains on children's clothes, use the Normal cycle with a hot Wash Temp. setting, plus the Pre Wash option and an Extra Rinse.
	Heavy Duty	This cycle is for washing heavily soiled laundry using more powerful wash motions.
	Allergiene™	This cycle is a powerful, high-temperature cycle designed specifically to reduce certain allergens.  <b>NOTE</b> <ul style="list-style-type: none"> <li>• Selecting the Allergiene™ cycle automatically incorporates steam into the wash cycle.</li> <li>• The Allergiene™ cycle can significantly reduce allergens in bedding and clothing.</li> <li>• The Allergiene™ cycle helps reduce dust mite populations and helps reduce allergens. Due to the higher energy and temperatures used, the Allergiene™ cycle is not recommended for wool, silk, leather, or any other delicate or temperature sensitive items.</li> </ul>
	Sanitary	NSF International (formerly the National Sanitation Foundation), certifies that his wash cycle reduces 99.9% of bacteria on laundry when used in conjunction with bleach, without high energy consumption.



**Protocol P172 Sanitization Performance of Residential and Commercial, Family Sized Clothes Washers**

**NOTE**

- This cycle has been certified by NSF using Tide HE powder.

## Cycle Guide

Cycle	Cycle Modifiers	Wash Temp.	Spin Speed	Soil Level	Delay Wash	Extra Rinse
Bright Whites™			Extra High	Heavy	•	•
	Turbo Wash™	Hot	High			
	Steam	Warm	Medium	Normal		
	Pre Wash	Cold	Low			
		Tap Cold	No Spin	Light		
Allergiene™			Extra High		•	•
	Turbo Wash™		High			
	Steam		Medium			
			Low			
			No Spin			
Sanitary		Extra Hot	Extra High	Heavy	•	•
	Turbo Wash™		High			
	Steam		Medium	Normal		
	Pre Wash		Low			
			No Spin	Light		
Bedding				Heavy	•	•
	Turbo Wash™	Hot				
	Steam	Warm	Medium	Normal		
	Cold Wash	Cold	Low			
	Pre Wash	Tap Cold	No Spin	Light		

### NOTE

- = available option,  = default setting
- Steam and Cold wash can't be selected at same time.

Cycle	Cycle Modifiers	Wash Temp.	Spin Speed	Soil Level	Delay Wash	Extra Rinse
Heavy Duty		Extra Hot	Extra High	Heavy	•	•
	Turbo Wash™	Hot	High			
	Steam	Warm	Medium	Normal		
	Cold Wash	Cold	Low			
	Pre Wash	Tap Cold		Light		
Normal		Extra Hot	Extra High	Heavy	•	•
	Turbo Wash™	Hot	High			
	Steam	Warm	Medium	Normal		
	Cold Wash	Cold	Low			
	Pre Wash	Tap Cold		Light		
Jumbo Wash				Heavy	•	•
	Turbo Wash™	Hot	High			
	Steam	Warm	Medium	Normal		
	Cold Wash	Cold	Low			
	Pre Wash	Tap Cold	No Spin	Light		
Perm.Press				Heavy	•	•
		Hot	High			
	Turbo Wash™	Warm	Medium	Normal		
	Cold Wash	Cold	Low			
	Pre Wash	Tap Cold		Light		

**NOTE**

- = available option,  = default setting
- Steam and Cold wash can't be selected at same time.



Cycle	Cycle Modifiers	Wash Temp.	Spin Speed	Soil Level	Delay Wash	Extra Rinse
Delicates				Heavy	•	•
	Pre Wash	Warm	Medium	Normal		
	Cold Wash	Cold	Low			
		Tap Cold	No Spin	Light		
Towels			Extra High	Heavy	•	•
		Hot	High			
	Turbo Wash™	Warm	Medium	Normal		
	Cold Wash	Cold	Low			
Speed Wash			Extra High	Heavy	•	•
		Hot	High			
	Turbo Wash™	Warm	Medium	Normal		
	Cold Wash	Cold	Low			
Rinse+Spin		Tap Cold	No Spin	Light	•	•
		Extra Hot	Extra High			
		Hot	High			
		Warm	Medium			
		Cold	Low			

**NOTE**

- = available option,  = default setting
- Steam and Cold wash can't be selected at same time.

Cycle	Cycle Modifiers	Wash Temp.	Spin Speed	Soil Level	Delay Wash	Extra Rinse
Tub Clean					•	
	Steam					
Sportswear				Heavy	•	•
		Warm	Medium	Normal		
		Cold	Low			
		Tap Cold	No Spin	Light		
Downloaded Default: Small Load			Extra High	Heavy	•	•
		Hot	High			
	Pre Wash	Warm	Medium	Normal		
	Cold Wash	Cold	Low			
		Tap Cold	No Spin	Light		

**NOTE**

- = available option,  = default setting
- Steam and Cold wash can't be selected at same time.

## Cycle Modifier Buttons

Each cycle has default settings that are selected automatically. You may also customize these settings using the cycle modifier buttons. Press the button for the desired modifier until the indicator light for the desired setting is lit. The washer automatically adjusts the water level for the type and size of wash load for best results and maximum efficiency. Due to the high-efficiency nature of this product, water levels may be much lower than expected. This is normal and cleaning/rinsing performance will not be compromised.

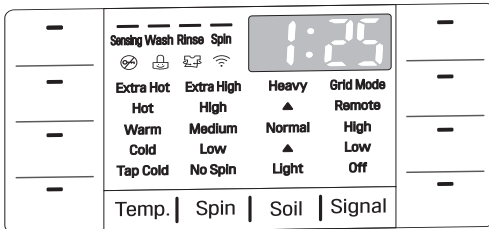

### Temp.

Temp. selects the wash and rinse temperature combination for the selected cycle. Press the **Temp.** button until the indicator light for the desired setting is lit. All rinses use tap cold water .

Cold rinses use less energy. The actual cold rinse temperature depends on the temperature of the cold water at the faucet.

Your washer features a heating element to boost the hot water temperature for Extra Hot settings. This provides improved wash performance at normal water heater settings.

#### NOTE

- Select the water temperature suitable for the type of load you are washing. Follow the garment fabric care labels for best results.
- Warm rinses are regulated at approximately 74 °F (23 °C).
- Warm rinses leave the clothes dryer than cold rinses, but will result in increased energy consumption and greater wrinkling of clothes.

### Spin

Higher spin speeds extract more water from clothes, reducing drying time and saving energy. Press the **Spin** button until the desired speed is selected. Some fabrics, such as delicates, require a slower spin speed. To protect your clothing, not all spin speeds are available for all cycles.

- The Spin button also activates the Drain+Spin cycle to drain the tub and spin clothes; for example, if you want to remove clothes before the cycle has ended. To use Drain+Spin, press the **Power** button, then press the **Spin** button repeatedly to select a spin speed. Press the **Start/Pause** button to begin.

### Soil

Adjusting the soil level setting will modify the cycle times and/or wash actions. Press the **Soil** button until the desired soil level is selected.

#### NOTE

- This feature needs more time for heavily soiled loads or less time for lightly soiled loads.

### Signal

The washer plays a melody when the wash cycle is finished. The buttons make a sound each time a button is pressed. Use this option to adjust the volume of the melody and button tones.

## Special Cycles/Features

After selecting a cycle, press the buttons to select additional features for your load.

### NOTE

- To protect your garments, not every feature is available with every cycle.
- If the Start/Pause button is not pressed within 60 minutes to start the cycle, the control will shut off and all settings will be lost.

### Pre Wash

Pre-wash for 15 minutes when clothes are covered in dirt or dust. This feature is suitable for heavily soiled items.

### Rinse+Spin

Select this cycle to rinse and spin a load separately from a regular cycle. This can be helpful in preventing fresh stains from setting in fabrics. You can change the spin speed by pressing the **Spin** button.

- 1 Press the **Power** button to turn on the washer.
- 2 Press the special use button until the Rinse+Spin indicator light is lit.
- 3 Press the **Start/Pause** button to start the cycle.

### Drum Light

The drum is equipped with a white LED light that illuminates when the washer is turned on. This light automatically turns off when the door is closed and the cycle starts.

- Press and hold the **Extra Rinse** button for three seconds during the cycle to turn on the drum light.
- The drum light will turn off automatically after four minutes.

## Option Buttons

Your washer features several additional cycle options that customize cycles to meet your individual needs. To use these options, select the desired option after selecting the desired cycle.

After selecting the desired cycle and settings, press the cycle option button(s) for the option(s) you would like to add. The button will light when that option is selected. If the selected option is not allowed for the selected cycle, the chime will sound twice to alert you and the LED will not illuminate.

### NOTE

- To protect your garments, not every feature is available with every cycle.
- If the Start/Pause button is not pressed within 60 minutes to start the cycle, the control will shut off and all settings will be lost.

### Delay Wash

Once you have selected the cycle and other settings, press this button to delay the start of the wash cycle. Each press of the button increases the delay time by 1 hour, for up to 19 hours. Once the desired delay time is set, press the **Start/Pause** button to start the delay time.

### NOTE

- If the Start/Pause button is not pressed to begin the delay time, the washer will automatically shut off after 60 minutes and all cycle settings will be lost.

### Extra Rinse

This option will add an extra rinse to the selected cycle. Use this option to help ensure the removal of detergent or bleach residue from fabrics. Liquid fabric softener, if used, is always dispensed in the final rinse. Pressing the **Extra Rinse** button twice will add two additional rinses to the cycle.

### Fresh Care

Use this function when you won't be able to take out your clothes immediately after the wash cycle ends. After the cycle ends, the drum will tumble periodically for up to 19 hours to prevent wrinkles. Press the **Start/Pause** or **Power** button at any time to unload laundry.

Press and hold the **Steam** button for three seconds during the wash cycle to activate the Fresh Care function.

## Cold Wash

This option saves energy by using cooler water while increasing the wash and rinse times to maintain wash performance.

### NOTE

- Wash time will increase up to several minutes with the Cold Wash option.
- For best wash results, only wash small loads (less than 8 lb) with the Cold Wash option.

## Add Garments

Use this function to add garments or remove foreign objects like coins or keys after the cycle has started.

- 1 Press **Add Garments**. The cycle pauses and the door unlocks.
- 2 Open the door, add garments or remove foreign objects, and close the door.
- 3 Press the **Start/Pause** button to start the cycle. The cycle continues automatically.

### NOTE

- After checking the water level/temperature conditions for safety, the door unlocks once the wash movement has stopped. (Door Lock LED turns off.)
- This may take several seconds depending on the water level. When a lot of water is in the tub, the door unlocks after water drains to a safe level.
- If the temperature in the tub is higher than 113 °F (45 °C), a short warning chime sounds and Add Garments is not allowed for safety.
- Add Garments is disabled during the Tub Clean cycle or while a cycle is in Spin mode for safety.
- To preserve wash performance, wash time may be extended depending on when garments are added to a cycle.

### WARNING

- Be careful when opening the door as wet laundry may drip or fall out when the door is opened.
- Do not attempt to force the door to open when locked. Doing so could result in damage to the machine, malfunction, or personal injury.

## Child Lock

Use this option to disable the controls. This feature can prevent children from changing cycles or operating the machine. The feature does not lock the lid. Once the Child Lock is set, it must be deactivated before any controls, except the Power button, can be used. Once the washer has shut off, the Power button will allow the machine to be turned on, but the controls will still be locked. When the controls are locked,  will display alternately with the estimated time remaining. Press and hold the **Pre Wash** button for seconds to activate or deactivate Child Lock.

### NOTE

- Once the controls are locked, they must be manually unlocked to restore operation.

## Turbo Wash™

Adding the Turbo Wash™ option reduces the cycle time while still providing similar wash performance to the same cycle without Turbo Wash™.

### NOTE

- The Turbo Wash™ option cannot be used with all cycles.
- Turbo Wash™ defaults to on for Normal, Heavy Duty and Perm.Press wash cycles.

## Steam

Adding the Steam option to a wash cycle helps provide superior cleaning performance. By using hot steam, the fabrics will get the cleaning benefits of a very hot wash.

### NOTE

- The Steam option cannot be used with all cycles.
- Steam may not be clearly visible during the steam cycles. This is normal. Too much steam could damage clothing.
- Do not use steam with delicate fabrics such as wool, silk, or easily discolored fabrics.

### WARNING

- Do not touch the door during steam cycles. The door surface can become very hot. Allow the door lock to release before opening the door.
- Do not attempt to override the door lock mechanism or reach into the washer during a steam cycle. Steam can cause severe burns.

# SMART FUNCTIONS

## Smart Appliance Connectivity

### Connectivity Overview

This smart appliance offers options for doing laundry. Once it is connected to the internet through a home Wi-Fi network, it can check the progress of a cycle and control the appliance remotely with the LG Smart Laundry & DW application for the smart phone.

The application can be set up to send push notifications when the cycle is complete or the appliance has problems. It also provides a list of extra cycles available for download, and helps to troubleshoot problems by recording and analyzing data from the appliance. The appliance has Smart Grid capability for areas where the utility company has installed Smart Grid equipment. This feature adjusts the appliance operating times based on when electricity prices are lower or delays operation when the demand for electricity is high.

### Connectivity Setup

#### Installing LG Smart Laundry & DW Application

- 1 Run the Google Play Store on an Android smart phone.
- 2 Search for LG Smart Laundry & DW.
- 3 Press **LG Smart Laundry & DW** on the resulting list.
- 4 Press **Install** and **Accept** to automatically install the application. You can also check the progress through the smart phone.
- 5 When the installation is complete, touch the icon to access the application.

- LG Smart Laundry & DW application for iOS devices will be supported later.

### Profile Setup (ID and Password Setup)

You can skip these steps if you already have an LG account at <http://us.smartthinQ.com>

- 1 Run the LG Smart Laundry & DW application on a smart phone.
- 2 Select **Login** at the bottom of the screen.
- 3 Select **Create an account** at the bottom of the screen.
- 4 On the next page, agree to the Terms and Conditions, Privacy Policy, and LG Account Terms and Conditions. After selecting **I agree**, press **Confirm**.
- 5 Next, in the email box, enter your email address. This will be your user ID. You will receive a confirmation email for activating the account at that email address.
- 6 Enter a password. Passwords are case sensitive. The password should be 6-12 characters. Remember your ID and password. They will be used on the LG Smart Laundry & DW application to use Smart Appliance Connectivity functions.
- 7 Enter your name.
- 8 Enter your mobile number.
- 9 Press the **Subscribe** button. The system will send you an email containing a link to confirm your identity for the account.
- 10 Press the **Confirm** button in the confirmation email, and the website will display a confirmation page. Your account is now set up.

## Product Registration and Wi-Fi Setup

- 1 Run the LG Smart Laundry & DW application on a smart phone.
- 2 Select **Smart Appliance**.
- 3 Select **Washer**.
- 4 Select **Front Load**.
  - If you see a pop-up message about NFC, press the Cancel button.
- 5 Press the **Wi-Fi model** button at the bottom of the screen.
- 6 Enter the email ID and password you registered.
 

If you don't have an account at <http://us.smarthinQ.com>, press the **Create an account** button and create a user ID and password.
- 7 Select the **Login** button.
- 8 On the next page, the application shows the Wi-Fi network list. Select your home network. If your network requires a key, enter the password and select the **Connect** button.
- 9 If the application successfully connects to the home network, turn on the washer and then press and hold the **Wi-Fi Connect** button on the washer for three seconds.
 

After powering on the washer, do not press any other buttons before pressing and holding the **Wi-Fi Connect** button. The Wi-Fi connection indicator on the washer blinks to indicate the machine is connecting.
- 10 The application now works to connect the appliance and register it as a Wi-Fi product. A notification appears when the washer is successfully set up and the product registration and Wi-Fi setup is complete. The Wi-Fi connection indicator illuminates when the machine connects to the home network.

### NOTE

- LG electronics is not responsible for any network connection problems or any faults, malfunctions, or errors caused by network connection.
- The machine supports 2.4 GHz Wi-Fi networks only.
- Use the Settings menu in the application to register or change the machine. Select Settings > Change Product > Add Product and then follow steps 2–10 above.
- If the router or the router's password is changed, select Settings > Change Product > Add Product and then follow steps 2–10 above.
- If the appliance is having trouble connecting to the Wi-Fi network, it may be too far from the router. Purchase a Wi-Fi repeater (range extender) to improve the Wi-Fi signal strength.
- The Wi-Fi connection may not connect or may be interrupted because of the home network environment.
- The network connection may not work properly depending on the Internet service provider.
- The surrounding wireless environment can make the wireless network service run slowly.
- This information is current at the time of publication. The application is subject to change for product improvement purposes without notice to users.

## Smart ThinQ™

### Remote Start

Use a smart phone to control the appliance remotely. Or monitor the cycle operation to see the remaining time left in the cycle.

### NOTE

- You must first connect to a gateway and register the appliance in order to use the Remote Start.
- The Remote LED on the control panel should be illuminated.

## Using Remote Start

- 1 Press and hold the **Remote Start** button. The Remote LED on the control panel is illuminated if the appliance is connected to a Wi-Fi network.
- 2 Start a cycle from the application on a smart phone. If the cycle is not started, the machine will wait to start the cycle until it is turned off remotely from the application or the Remote Start mode is disabled.

### NOTE

- Cycles and options cannot be selected at the appliance when the machine is in Remote Start mode.
- Press and hold the **Remote Start** button again to enable the Remote Start mode when the appliance is turned off or the Remote Start mode is released.

## Smart Grid

Reduce energy costs from washing clothes by avoiding peak usage periods, with information supplied by the local electric utility company. If the utility company has equipped Smart Grid technology, contact the utility company for information regarding the Smart Grid features.

### NOTE

- When Smart Grid is enabled, you may experience delays or extended cycle times during peak usage periods.
- You must first connect to a gateway and register the appliance in order to use the Smart Grid function.

## Download Cycle

Download new and special cycles that are not included in the basic cycles on the appliance.

Appliances that have been successfully registered can download a variety of specialty cycles specific to the appliance.

Only one cycle can be stored on the appliance at a time. Once Download Cycle is completed in the washer, the product keeps the downloaded cycle until a new cycle is downloaded.

### NOTE

- You must first connect to a gateway and register the appliance in order to use the Download cycle function.

## Smart Diagnosis™

Use a phone to record the Smart Diagnosis™ signal to solve problems with the appliance. The application can analyze the signal and help you solve the problem without waiting for a technician.

## Cycle Set

Choose the best cycle and settings based on laundry needs. Once you have selected a cycle based on the Cycle Set guide, the cycle and settings are automatically set.

### NOTE

- Cycle Set function can be enabled when the Remote Start button is activated.

## Laundry Stats

Learn basic stats about the appliance such as the cycle history and basic maintenance timing. Select **Laundry Stats** at the application to get the stats and find out when the washer's next Tub Clean is due.

### NOTE

- You must first connect to a gateway and register the appliance in order to use the Laundry Stats function.

## Smart Message

When the cycle is complete or the appliance has problems, you have the option of receiving push notifications on a smart phone.

### NOTE

- You must first connect to a gateway and register the appliance in order to use the Smart Message function.

## Energy Monitoring

The washer energy usage is affected by the cycle and options so you may see some changes in energy usage from one cycle to another.

### NOTE

- You must first connect to a gateway and register the appliance in order to use the Energy Monitoring function.



## Open Source Software Notice Information

To obtain the source code under GPL, LGPL, MPL, and other open source licenses, that is contained in this product, please visit <http://opensource.lge.com>.

In addition to the source code, all referred license terms, warranty disclaimers and copyright notices are available for download.

LG Electronics will also provide open source code to you on CD-ROM for a charge covering the cost of performing such distribution (such as the cost of media, shipping, and handling) upon email request to [opensource@lge.com](mailto:opensource@lge.com). This offer is valid for three (3) years from the date on which you purchased the product.

Wireless Module (LCW-003) Specifications	
Frequency Range	2412~2462 MHz
Output Power (max.)	IEEE 802.11 b : 14 dBm
	IEEE 802.11 g : 15 dBm
	IEEE 802.11 n : 14 dBm

## FCC Notice (For transmitter module contained in this product)

This equipment has been tested and found to comply with the limits for a Class B digital device, pursuant to Part 15 of the FCC Rules. These limits are designed to provide reasonable protection against harmful interference in a residential installation. This equipment generates, uses, and can radiate radio frequency energy and, if not installed and used in accordance with the instructions, may cause harmful interference to radio communications. However, there is no guarantee that interference will not occur in a particular installation. If this equipment does cause harmful interference to radio or television reception, which can be determined by turning the equipment off and on, the user is encouraged to try to correct the interference by one or more of the following measures:

- Reorient or relocate the receiving antenna.
- Increase the separation between the equipment and the receiver.
- Connect the equipment to an outlet on a circuit different from that to which the receiver is connected.
- Consult the dealer or an experienced radio/TV technician for help.

This device complies with part 15 of the FCC Rules. Operation is subject to the following two conditions:

- 1) this device may not cause harmful interference and
- 2) this device must accept any interference received, including interference that may cause undesired operation of the device.

Any changes or modifications in construction of this device which are not expressly approved by the party responsible for compliance could void the user's authority to operate the equipment.

## FCC RF Radiation Exposure Statement

This equipment complies with FCC radiation exposure limits set forth for an uncontrolled environment. This transmitter must not be co-located or operating in conjunction with any other antenna or transmitter.

This equipment should be installed and operated with minimum distance 20 cm (7.8 inches) between the antenna and your body. Users must follow the specific operating instructions for satisfying RF exposure compliance.

## Using Smart Diagnosis™

Should you experience any problems with your washer, it has the capability of transmitting data to your smart phone using the LG Smart Laundry & DW application or via your telephone to the LG call center.

Smart Diagnosis™ cannot be activated unless your washer is turned on by pressing the **Power** button. If your washer is unable to turn on, then troubleshooting must be done without using Smart Diagnosis™.

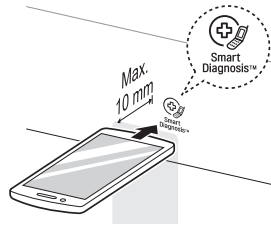

### Smart Diagnosis™ Through The Customer Information Center

- 1 Call the LG call center at:  
(USA) 1-800-984-6306
- 2 When instructed to do so by the call center agent, hold the mouthpiece of your phone over the Smart Diagnosis™ logo on the machine. Hold the phone no more than one inch from (but not touching) the machine.
- 3 Press and hold **Temp.** for three seconds.

#### NOTE

- Do not touch any other buttons or icons on the display screen.
- 4 Keep the phone in place until the tone transmission has finished. The display will count down the time.
  - 5 Once the countdown is over and the tones have stopped, resume your conversation with the call center agent, who will then be able to assist you in using the information transmitted for analysis.

#### NOTE

- For best results, do not move the phone while the tones are being transmitted.
- If the call center agent is not able to get an accurate recording of the data, you may be asked to try again.

# MAINTENANCE

## WARNING

To reduce the risk of fire, electric shock, or injury to persons, read and follow this entire Owner's Manual, including the Important Safety Instructions, before operating this washer.

- Unplug the washer before cleaning to avoid the risk of electric shock. Failure to follow this warning can cause serious injury, fire, electric shock, or death.
- Do not use volatile substances (benzene, paint thinner, alcohol, acetone, etc.) or detergents with strong chemical components when cleaning the washer. Doing so may cause discoloration or damage to the machine, or may cause a fire.

## NOTE

- Never use harsh chemicals, abrasive cleaners, or solvents to clean the washer. They will damage the finish.

## Regular Cleaning

### Care After Wash

After the cycle is finished, wipe the door and the inside of the door seal to remove any moisture.

- Leave the door open to dry the drum interior.
- Wipe the body of the washer with a dry cloth to remove any moisture.

### Cleaning the Exterior

Proper care of your washer can extend its life.

#### Door:

Wash with a damp cloth on the outside and inside and then dry with a soft cloth.

#### Exterior:

- Immediately wipe off any spills.
- Wipe with a damp cloth.
- Do not touch the surface or the display with sharp objects.

### Care and Cleaning of the Interior

- Use a towel or soft cloth to wipe around the washer door opening and door glass.
- Always remove items from the washer as soon as the cycle is complete. Leaving damp items in the washer can cause wrinkling, color transfer, and odor.
- Run the Tub Clean cycle once a month, or more often if needed, to remove detergent buildup and other residue.

### Tub Clean Cycle

- Some environmental and usage conditions can cause a residue to build up in the drum over time and can lead to a mildewy or musty smell. The Tub Clean cycle is specially designed to remove this buildup using bleach or other cleaners designed specifically for cleaning washers. Run the Tub Clean cycle once a month, or more often under heavy use conditions or if odor is present.

- 1 Remove any clothing from the drum.
- 2 Add cleaning agents.
  - For other drum cleaning products, follow the cleaner manufacturer's instructions and recommendations.
  - Do not exceed the maximum fill line when adding bleach or powdered cleaners. Powdered detergent may remain in the drum after cleaning.
- 3 Close the door and press the **Power** button to turn the washer on.
- 4 Turn the cycle selector to select the **Tub Clean** cycle.
- 5 Press the **Start/Pause** button to begin the cycle. Selecting any other cycle after Tub Clean has been selected will cause the Tub Clean cycle to be cancelled.
- 6 After the cycle ends, open the door and allow the drum interior to dry completely.

Cleaner	Instructions
Tub cleaner	Add to main detergent compartment of detergent dispenser lid
Lime scale remover	
Liquid chlorine bleach	Add to bleach compartment of detergent dispenser lid
Powdered cleaner	Pull out liquid detergent cup before adding to main detergent compartment
Cleaning tablets	Place directly into washer drum

**NOTE**

- Never load laundry while using Tub Clean. The laundry may be damaged or contaminated with cleaning products. Make sure to run the Tub Clean cycle only when the drum is empty.
- Leave the door open after finishing the laundry, to keep the drum clean.
- Tub Clean should be repeated monthly.
- If mildew or musty smell already exists, run Tub Clean once a week for three consecutive weeks.
- For other drum cleaning products, follow the cleaner manufacturer's instructions and recommendations.
- Do not exceed the maximum fill line when adding bleach or powdered cleaners. Powdered detergent may remain in the drum after cleaning.

**Automatic Alert for Tub Clean**

When the power is on and the **L C L** message blinks on the display, it means the washer drum needs cleaning. Use the Tub Clean cycle to clean the washer drum. The frequency of the automatic alert's appearance depends on how often the washer is used, however the message will generally appear every one to two months.

**Removing Mineral Buildup**

In areas with hard water, mineral scale can form on internal components of the washer. Periodically clean the mineral buildup on the internal components to extend the lifespan of the washer. Use of a water softener is recommended in areas with hard water.

- Use a descaler, such as Washer Magic®, to remove visible mineral buildup on the washer drum.

After descaling, always run the Tub Clean cycle before washing clothing.

- Mineral scale and other spots may be removed from the stainless steel drum using a soft cloth soaked in stainless steel cleaner.
- Do not use steel wool or abrasive cleaners.

**Cleaning the Dispenser Lid**

Detergent and fabric softener may build up in the dispenser lid. Remove the lid and inserts and check for buildup once or twice a month.

- 1 Slide the detergent dispenser lid open.
- 2 Remove the detergent dispenser covers and pull out the detergent cups.

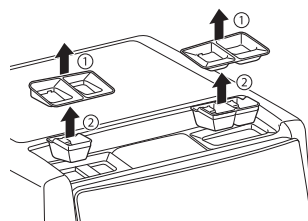

- 3 Clean parts with warm water.
  - Use a soft cloth or brush for cleaning and to remove any residue.

**! WARNING**

- Do not spray water inside the cabinet. Doing so may cause fire or electric shock.

- 4 Wipe off any moisture with a dry towel or cloth after cleaning.
- 5 Replace the detergent cups and detergent dispenser covers.

**NOTE**

- If you use a descaler or tub cleaner during the Tub Clean cycle, use the Rinse+Spin cycle to rinse the washer drum before running your next wash cycle.

## Cleaning the Door Seal

Clean the door seal once a month to prevent build-up of dirt.

- 1 **Wear rubber gloves and protective goggles.**
- 2 **Dilute 3/4 cup (177 ml) of liquid chlorine bleach in 1 gallon (3.8 L) of water.**
- 3 **Wipe around the door seal.**  
Soak a sponge or a soft cloth in this diluted solution and wipe all around the door seal.
- 4 **Wipe dry.**  
After cleaning, wipe up any moisture with a dry towel or cloth.
- 5 **Leave the door open to allow the door seal to dry completely.**

### CAUTION

- Cleaning the door seal with undiluted bleach may cause malfunction of the door seal and washer parts. You must add water to the bleach before using it.

## Cleaning the Water Inlet Filters

If the washer does not fill properly, an error message will show on the display. The inlet valve filter screens could be plugged by hard water scale, sediment in the water supply, or other debris.

### CAUTION

- The inlet screens protect the delicate parts of the inlet valve from being damaged by particles that could enter the valves with the water supply. Operating the washer with these filters removed could cause a valve to stick open resulting in flooding and/or property damage
- Do not use the washer without the inlet filters. If you use the washer without the inlet filters it will cause leaks and malfunction.
- If you use the washer in an area with hard water, the inlet filter may clog due to lime buildup.

- 1 **Turn off both water faucets completely.**
- 2 **Unscrew the hot and cold water hoses from the back of the washer.**
- 3 **Carefully remove the filters from the water valves.**
- 4 **Remove foreign objects and soak the filters in white vinegar or a lime scale remover.**  
If using a lime scale remover, follow the manufacturer's instructions. Be careful not to damage the filters while cleaning them.
- 5 **Rinse filters thoroughly and press them back into place.**
- 6 **Flush then reattach the water hoses.**  
Before reattaching the hoses, flush the hoses and water lines by running several gallons of water into a bucket or drain, preferably with the faucets wide open for maximum flow.

### NOTE

- An *IE* message may blink on the display when the water pressure is weak or an inlet filter is clogged with dirt. Clean the inlet filter.

## Cleaning the Drain Pump Filter

The washer fails to drain if the drain pump filter is clogged. Periodically clean the drain filter to prevent clogging with foreign objects.

### WARNING

- Opening the drain filter will result in water overflowing if there is water in the washer drum. Use a bucket if the drum is not completely drained before you open the drain filter.
- Using the washer without the drain filter or with an incorrectly assembled drain filter may cause leaks or malfunctioning of the washer.

**1 Turn off the machine and pull out the plug.**

**2 Open the drain pump filter cover.**

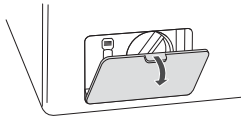

**3 Drain any remaining water.**

Unclip the drain hose and remove the plug from the drain hose to drain the remaining water.

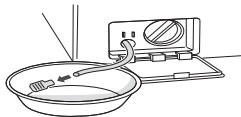

**4 Remove the pump filter.**

Twist the pump filter counterclockwise to remove.

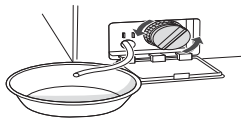

**5 Clean the pump filter and opening.**

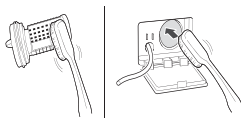

**6 Recap the plug onto the drain hose and attach the drain hose.**

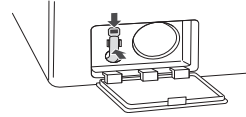

**7 Insert the drain pump filter.**

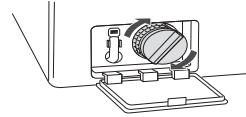

**8 Close the drain pump filter cover.**

### NOTE

- An **DE** message blinks on the display when the drain pump filter is clogged with dirt. Clean the drain pump filter.

## Care in Cold Climates

### Storing the Washer

If the washer will not be used for an extended period of time and is in an area that could be exposed to freezing temperatures, perform the following steps to protect the washer from damage.

- 1 Turn off the water supply.
- 2 Disconnect hoses from water supply and drain water from hoses.

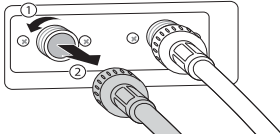

- 3 Plug the power cord into a properly grounded electrical outlet.  
Soak a sponge or a soft cloth in this diluted solution and wipe all around the door seal.
- 4 Add 1 gallon of nontoxic recreational vehicle (RV) antifreeze to the empty drum and close the door. Never use automotive antifreeze.
- 5 Press the **Power** button, then select **Spin**.
- 6 Press the **Start/Pause** button to start the drain pump.
- 7 Allow the drain pump to run for one minute, then press the **Power** button to shut off the washer. This will expel some of the antifreeze, leaving enough to protect the washer from damage.
- 8 Unplug the power cord, dry the drum interior with a soft cloth, and close the door.
- 9 Remove the inserts from the dispenser. Drain any water in the compartments and let them dry.
- 10 Store the washer in an upright position.
- 11 To remove the antifreeze from the washer after storage, run a complete Speed Wash cycle using detergent.  
Do not add laundry to this cycle.

### When the Water Line is Frozen

- 1 Turn off the faucets connected with the water lines.
- 2 Pour hot water on the frozen faucets to thaw the water lines and remove them.
- 3 Immerse the water lines in hot water to thaw them.
- 4 Connect the water lines with the water inlets of the washer and with the faucets.  
See Connecting the Water Lines for details.
- 5 Turn on the faucets.
- 6 Press the **Power** button.
- 7 Press the **Spin** button.
- 8 Press the **Start/Pause** button. Verify the water fills properly.

### When the Drain Line is Frozen

- 1 Pour hot water in the washer drum and close the lid. Wait for 1-2 hours.
- 2 Press the **Power** button after thawing.
- 3 Press the **Spin** button to select draining and spinning.
- 4 Press the **Start/Pause** button. Check to make sure the water drains.

# TROUBLESHOOTING

## FAQs: Frequently Asked Questions

**Q: Why does my washer make loud banging noises while it is filling with water?**

A: This is actually a problem with the plumbing in your home. When the water valve in the washer shuts off, it can cause pipes in your home to move, resulting in a loud banging noise. This effect, called water hammer, can be reduced by installing an item called a water hammer arrestor. Add-on arrestors can be purchased through your local hardware or home improvement store.

**Q: Why is there so little water in my washer? How can it clean the clothes?**

A: HE (High-Efficiency) washers are designed to properly wash your laundry while using a minimum amount of water and energy. Because the water volume is low, the small amount of detergent used is more concentrated in the water, resulting in excellent cleaning performance.

**Q: When I press a button, why does my washer beep and then nothing happens?**

A:

- The Child Lock feature is turned on. To turn off Child Lock, turn the washer on, then press and hold the button that has "Child Lock" on or under it for three seconds.
- Power or Signal is off.

**Q: Where should I pour my OxiClean™ or other powdered laundry products when doing my laundry?**

A: If you are using powdered laundry detergent, load it in the main detergent dispenser after removing the liquid detergent insert. Powdered laundry agents such as OxiClean™ or powdered color safe bleach should be put directly into the tub. These products can be put in the empty tub before loading or on top of the laundry after loading the machine.



## Before Calling for Service

The washer is equipped with an automatic error-monitoring system to detect and diagnose problems at an early stage. If your washer does not function properly or does not function at all, check the following before you call for service.

### Noises You Might Hear

Noise	Possible Cause	Solutions
<b>Spraying or Hissing</b>	<b>Water spraying or circulating during the cycle.</b>	Normal Operation
<b>Humming or Gurgling</b>	<b>Drain pump is pumping water from the washer at times during a cycle.</b>	Normal Operation
<b>Water sloshing</b>	<b>A liquid in the balance ring around the wash basket helps the basket spin smoothly.</b>	Normal Operation
<b>Water being added after the washer has already begun to operate</b>	<b>The washer adapts to the load size and type to add more water to the cycle as needed.</b>	Normal Operation
	<b>The wash load may be unbalanced. If the washer senses that the load is unbalanced, it will stop and refill to redistribute the load.</b>	
	<b>The washer may be diluting laundry additives to add to the wash load.</b>	
<b>Rattling and clanking noise</b>	<b>Foreign objects, such as keys, coins, or safety pins may be in drum or pump.</b>	Stop washer, check drum and drain filter for foreign objects. If noise continues after washer is restarted, call for service.
<b>Thumping sound</b>	<b>Heavy wash loads may produce a thumping sound.</b>	This is normal. If sound continues, washer is probably out of balance. Stop and redistribute wash load.
	<b>Wash load may be out of balance.</b>	Pause the cycle and redistribute the load.
<b>Vibrating noise</b>	<b>Packaging materials were not removed.</b>	See the Unpack and Remove Shipping Material information in the Installation section.
	<b>Wash load may be unevenly distributed in the drum.</b>	Pause the cycle and redistribute the load.
	<b>Not all leveling feet are resting firmly and evenly on the floor.</b>	See Level the Washer in the Installation section.
	<b>Floor not rigid enough.</b>	Make sure that the floor is solid and does no flex. See Flooring in the Installation Requirements section.
<b>Squeak noise</b>	<b>Packaging materials were not removed.</b>	See the Unpack and Remove Shipping Material information in the Installation section.
<b>Banging noise when washer is filling with water (Water Hammer)</b>	<b>Plumbing in the home moves or flexes when the water valves in the washer shut off.</b>	Water hammer is not caused by a defect in the washer. Install water hammer arrestors (purchased separately at hardware or home improvement store) between the fill hose and the washer for best results.
	<b>Household water supply pressure is very high.</b>	Adjust household water supply regulator to a lower pressure or contact a plumber.

## Operation

Problem	Possible Cause	Solutions
Water leaking	Inlet hose connection is loose at faucet or washer.	Check hoses for leaks, cracks and splits. Check and tighten hose connections.
	House drain pipes are clogged.	The washer pumps out water very rapidly. Check for water backing up out of the drain pipe during drain. If water is seen coming out of the drain, check for proper drain hose installation and check for restrictions in the drain. Contact a plumber to repair drain pipe.
	Drain hose has come out of drain or is not inserted far enough.	Tie drain hose to inlet hose or standpipe to prevent it from coming out during drain. For smaller drain pipes, insert the drain hose into the pipe as far as the drain hose flange. For larger drain pipes, insert the drain hose into the pipe 1-2 inches past the flange.
	A large item such as a pillow or blanket is above the top of the drum.	Use the Bulky cycle for large or bulky items. Use extra care and never wash more than half a load of items that float, such as pillows. Stop the washer and check the load. Make sure the load does not crest above the top edge of the drum.
Water leaks	Oversudsing of detergent.	Oversudsing may create leaks, and may be caused by the type and amount of detergent used. High-Efficiency detergent is the only detergent recommended. The normal amount of detergent to use is 1/4 to 1/2 of the maximum amount recommended by the detergent manufacturer.
Water leaks every load	Hoses not installed correctly.	Normal Operation
Washer will not drain water	Kinked drain hose.	Ensure that the drain hose is not kinked.
	Drain located improperly.	Make sure that the drain hose is no more than 5 ft. away from the washer.
Excessive sudsing	Too much detergent or incorrect detergent.	HE detergents are formulated specifically for High-Efficiency washers and contain suds-reducing agents. Only use detergent with the High-Efficiency (HE) logo.



Problem	Possible Cause	Solutions
Washer will not turn on	Power cord is not properly plugged in.	Make sure that the plug is plugged securely into a grounded, 3-prong, 120-VAC, 60 Hz outlet.
	House fuse is blown, circuit breaker has tripped, or power outage has occurred.	Reset circuit breaker or replace fuse. Do not increase fuse capacity. If the problem is a circuit overload, have it corrected by a qualified electrician.
Wash cycle time is longer than usual	The washer automatically adjusts the wash time for the amount of laundry, water pressure and other operating conditions.	This is normal. The washer adjusts cycle time automatically to provide optimal results for the selected cycle. The time remaining shown in the display is only an estimate. Actual time may vary.
Bleach does not dispense	Bleach dispenser cover is not properly installed.	Make sure that the bleach cover is properly installed and snapped into place before the beginning of the cycle.
	Bleach dispenser is dirty or clogged.	Lift out the bleach dispenser cover and clean out the reservoir. Lint and other foreign debris that collects in the inside of the dispenser may prevent proper dispensing of the bleach.
Premature dispensing of bleach	Bleach dispenser filled for future load.	You cannot store bleach in the dispenser for future use. The bleach will be dispensed every load.
Incomplete or no dispensing of detergent	Detergent compartments clogged from incorrect filling.	Make sure that detergent and additives are put into the correct dispenser compartments. For all detergent types, always make sure that the dispenser drawer is fully closed before the start of the cycle.
	Too much detergent used.	Make sure that the suggested amount of detergent is used per the manufacturer's recommendations. You may also dilute the detergent with water to the maximum fill line on the compartment to avoid clogging. Use only HE (High-Efficiency) detergent.  <b>NOTE:</b> Always use as little detergent as possible. High-Efficiency washers need very little detergent to achieve optimum results. Using too much detergent will cause poor wash and rinse performance and may contribute to odors in washer.
	Insufficient water supply.	Make sure that both hot and cold water faucets are turned on all the way.
	Normal residue.	It is normal for a small amount of detergent to remain in the dispenser. If this residue builds up it can interfere with normal dispensing of products. Refer to the cleaning instructions.





Problem	Possible Cause	Solutions
<b>Washer will not operate</b>	<b>Control panel has powered off due to inactivity.</b>	This is normal. Press the Power button to turn the washer on.
	<b>Washer is unplugged.</b>	Make sure cord is plugged securely into a working outlet.
	<b>Water supply is turned off.</b>	Turn both hot and cold faucets fully on.
	<b>Controls are not set properly.</b>	Make sure the cycle was set correctly, close the lid and press the Start/Pause button.
	<b>Lid is open.</b>	The washer will not operate if the lid is open. Close the lid and make sure that nothing is caught under the lid preventing it from closing completely.
	<b>Circuit breaker/fuse is tripped/blown.</b>	Check house circuit breakers/fuses. Replace fuses or reset breaker. The washer should be on a dedicated branch circuit. The washer will resume the cycle where it stopped once power is restored.
	<b>Control needs to be reset.</b>	Press the Power button, then re-select the desired cycle and press the Start/Pause button.
	<b>Start/Pause was not pressed after a cycle was set.</b>	Press the Power button then re-select the desired cycle and press the Start/Pause button. The washer will shut off if the Start/Pause button is not pressed within 60 minutes.
	<b>Extremely low water pressure.</b>	Check another faucet in the house to make sure that household water pressure is adequate.
	<b>Washer is too cold.</b>	If the washer has been exposed to temperatures below freezing for an extended period of time, allow it to warm up before pressing the Power button.  Otherwise, the display will not come on.
<b>Washer not filling properly</b>	<b>Filter clogged.</b>	Make sure the inlet filters on the fill valves are not clogged. Refer to the filter cleaning instructions.
	<b>Inlet hoses may be kinked.</b>	Check that inlet hoses are not kinked or clogged.
	<b>Energy efficiency.</b>	This is a High-Efficiency (HE) washer. As a result, the water level settings for this washer may be different than for conventional washers.
	<b>Insufficient water supply.</b>	Make sure that both hot and cold water faucets are turned on all the way.
	<b>The washer lid is open.</b>	The washer will not operate if the lid is open. Close the lid and make sure that nothing is caught under the lid preventing it from closing completely.
<b>Water level is too low/ No water is visible in the drum</b>	<b>Energy efficiency</b>	This is a High-Efficiency (HE) washer. As a result, the water level settings for this washer may be different than on your previous washer. The water will not normally cover the clothes. The fill level is optimized for the wash motion to achieve the best wash performance.

## Performance

Problem	Possible Cause	Solutions
Wrinkling	<b>Washer not unloaded promptly.</b>	Always remove items from the washer as soon as the cycle is complete.
	<b>Washer overloaded.</b>	The washer can be fully loaded, but the drum should not be tightly packed with items. The lid of the washer should close easily.
	<b>Hot and cold water inlet hoses are reversed.</b>	Hot water rinse can set wrinkles in garments. Check the inlet hose connections.
Staining	<b>Bleach or softener dispensed too soon.</b>	Dispenser compartment is overfilled causing bleach or softener to dispense immediately. Always measure bleach to prevent overfilling - one cup maximum. Dispenser drawer closed too quickly causing softener to dispense immediately.
	<b>Bleach or softener was added directly to the wash load in the drum.</b>	Always use the dispensers to ensure that laundry products are properly dispensed at the right time in the cycle.
	<b>Washer was not unloaded promptly.</b>	Always remove items from the washer as soon as possible after the cycle is complete.
	<b>Clothes were not properly sorted.</b>	Always wash dark colors separately from light colors and whites to prevent discoloration. Never wash heavily soiled items with lightly soiled items.
Poor stain removal	<b>Proper options not selected.</b>	Heavier soils and tougher stains may require extra cleaning power. Select the Soak or Stain Care feature to boost the cleaning power of the selected cycle.
	<b>Previously set stains.</b>	Articles that have previously been washed may have stains that have been set. These stains may be difficult to remove and may require hand washing or pre-treating to aid in stain removal.
Musty or mildewy odor in washer	<b>Incorrect or too much detergent has been used.</b>	Use only High-Efficiency (HE) detergent in accordance with the manufacturer's instructions.
	<b>Inside of drum was not cleaned properly.</b>	Run the Tub clean cycle regularly.
	<b>Lint filters have not been cleaned for a long time.</b>	Clean out the lint filters.
Strange odors coming from washer	<b>Dryer heating.</b>	As the dryer heats, it may initially cause a slight odor. This is normal and does not affect performance.
	<b>Newly installed washer.</b>	Smell comes from the rubber attached to the washer door. It will eventually dissipate after first couple of wash cycles.
	<b>Build-up of residue on washer, foreign object in door gasket, clogged drain pump filter, clogged or kinked drain hose.</b>	Periodically clean the gasket. Mold and foreign substances inside the gasket may produce mildew or musty smells.
		Clean the drain pump filter regularly. Foreign substances on the drain pump filter may produce mildew or musty smells.
		If the drain hose is not installed properly, the odor may be emitted because of a backflow of drainage into the tub. Make sure that the drain hose is not kinked or clogged.

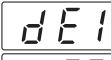
## Error Codes

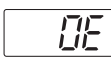
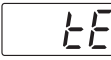
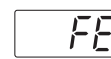
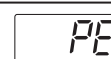
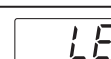
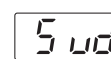
Problem	Possible Cause	Solutions
<b>Washer fills with water slowly or not at all, or</b> 	<b>Water supply faucets are not fully open.</b>	Make sure that the water faucets are fully open.
	<b>Water line hoses are kinked, pinched, or crushed.</b>	Make sure that the hoses are not kinked or pinched. Be careful when moving the washer during cleaning and maintenance.
	<b>Water inlet filters are clogged.</b>	Clean the inlet filters. See Maintenance in the Care and Cleaning section.
	<b>Water supply pressure to faucet or house is too low.</b>	Check another faucet in the house to make sure that household water pressure is adequate and flow is not restricted. Disconnect the inlet hose from the washer and run a few gallons of water through the hose to flush the water supply lines. If flow is too low, contact a plumber to have the water lines repaired.
	<b>Water supply connected with leaklimiting hoses.</b>	Hoses designed to limit leaks can trip falsely and prevent the washer from filling. The use of leak limiting hoses is not recommended.
	<b>If the balance is not successful, this error will be displayed.</b>	The automatic attempt to rebalance the load was not successful. The cycle has been paused to allow the load to be manually adjusted.
	<b>The load is too small.</b>	Small loads may need additional items to be added to allow the washer to balance the loads.
	<b>Heavy articles are mixed with lighter items.</b>	The load may have heavy items loaded with lighter items. Always try to wash articles of somewhat similar weight to allow the washer to evenly distribute the weight of the load for spinning.
	<b>The load is out of balance.</b>	Manually redistribute the load if articles have become tangled preventing the automatic distribution from working properly.

Problem	Possible Cause	Solutions
<p>The tub does not rotate or</p>   	The door is not secured.	Close and secure the door. If the message keeps appearing, unplug the power cord and call for service.
<p>Water in the washer drains slowly or not at all and</p> 	<p>Drain hose is kinked, pinched, or clogged</p> <p>Drain discharge is more than 96 inches (2.4 m) above bottom of washer.</p>	<p>Make sure the drain hose is free of clogs, inks, etc., and is not pinched behind or under the washer.</p> <p>Use the drain 96 inches (2.4 m) above the bottom of the washer.</p>
	Control error.	Unplug the washer and wait 60 seconds. Reconnect power and try again. If the error reappears, call for service.
	Water level is too high due to a faulty water valve.	Close the water faucets, unplug the washer, and call for service.
	The water level sensor is not working correctly.	Close the water faucets, unplug the washer, and call for service.
	A motor error has occurred.	Allow the washer to stand for 30 minutes and then restart the cycle. If the LE error code persists, call for service.
	If the washing machine detects too many suds, it displays this error code and adds a Suds Reducing cycle. This adds about 2 hours to the cycle time. If too many suds are detected during spinning, the washing machine stops to help prevent leaking.	Do not add more than the manufacturer's recommended amount of detergent.
	The water level too low or high compared with the size of the load.	The water level sensor is not working correctly. Unplug the power cord and call for service.

## WARRANTY (USA)

Should your LG Washer fail due to a defect in materials or workmanship under normal home use, during the warranty period set forth below, LG will at its option repair or replace the product. This limited warranty is valid only to the original retail purchaser of the product and applies only when purchased and used within the United States, including U.S. Territories. Proof of original retail purchase is required to obtain warranty service under this limited warranty.

Warranty Period	Scope of Warranty	Remark
One (1) year from date of original retail purchase	Any internal / functional Parts and Labor	LG will provide parts and labor to repair or replace defective parts.
Ten (10) years from date of original retail purchase	DD Motor (Stator, Rotor, Hall Sensor)	Parts only. Customer will be responsible for any labor or in-home service to replace defective parts.
Limited Lifetime	Stainless Steel Drum	

- Replacement products and parts are warranted for the remaining portion of the original warranty period or ninety (90) days, whichever is greater.
- Replacement products and parts may be new or remanufactured.

**THIS WARRANTY IS IN LIEU OF ANY OTHER WARRANTY, EXPRESS OR IMPLIED, INCLUDING WITHOUT LIMITATION, ANY WARRANTY OF MERCHANTABILITY OR FITNESS FOR A PARTICULAR PURPOSE. TO THE EXTENT ANY IMPLIED WARRANTY IS REQUIRED BY LAW, IT IS LIMITED IN DURATION TO THE EXPRESS WARRANTY PERIOD ABOVE. NEITHER THE MANUFACTURER NOR ITS U.S. DISTRIBUTOR SHALL BE LIABLE FOR ANY INCIDENTAL, CONSEQUENTIAL, INDIRECT, SPECIAL, OR PUNITIVE DAMAGES OF ANY NATURE, INCLUDING WITHOUT LIMITATION, LOST REVENUES OR PROFITS, OR ANY OTHER DAMAGE WHETHER BASED IN CONTRACT, TORT, OR OTHERWISE.**

Some states do not allow the exclusion or limitation of incidental or consequential damages or limitations on how long an implied warranty lasts, so the above exclusion or limitation may not apply to you. This warranty gives you specific legal rights and you may also have other rights that vary from state to state.

### **THIS LIMITED WARRANTY DOES NOT COVER:**

- Service trips to deliver, pick up, or install or repair the product; instruction to the customer on operation of the product; repair or replacement of fuses or correction of wiring or plumbing, or correction of unauthorized repairs/installation.
- Failure of the product to perform during power failures and interrupted or inadequate electrical service.
- Damage caused by leaky or broken water pipes, frozen water pipes, restricted drain lines, inadequate or interrupted water supply or inadequate supply of air.
- Damage resulting from operating the product in a corrosive atmosphere or contrary to the instructions outlined in the product's owner's manual.
- Damage to the product caused by accidents, pests and vermin, lightning, wind, fire, floods, or acts of God.
- Damage or failure caused by unauthorized modification or alteration, or if it is used for other than the intended purpose, or any water leakage where the unit was not properly installed.
- Damage or failure caused by incorrect electrical current, voltage, or plumbing codes, commercial or industrial use, or use of accessories, components, or consumable cleaning products that are not approved by LG.



- Damage caused by transportation and handling, including scratches, dents, chips, and/or other damage to the finish of your product, unless such damage results from defects in materials or workmanship and is reported within one (1) week of delivery.
- Damage or missing items to any display, open box, discounted, or refurbished product.
- Products with original serial numbers that have been removed, altered, or cannot be readily determined. Model and serial numbers, along with original retail sales receipts, are required for warranty validation.
- Increases in utility costs and additional utility expenses.
- Repairs when your product is used for other than normal and usual household use (e.g. commercial use, in offices and recreational facilities) or contrary to the instructions outlined in the product's owner's manual.
- Costs associated with removal of your product from your home for repairs.
- The removal and reinstallation of the product if it is installed in an inaccessible location or is not installed in accordance with published installation instructions, including LG's owner's and installation manuals.
- Damage resulting from misuse, abuse, improper installation, repair, or maintenance. Improper repair includes use of parts not approved or specified by LG.

Strange vibration or noise caused by not removing transit bolts or tub support.

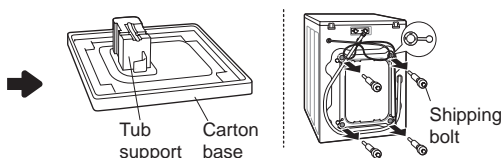

Remove the shipping bolts & tub support.

Leakage caused by dirt (hair, lint) on seal and door glass.

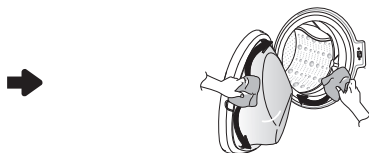

Clean the seal & door glass.

Not draining caused by clogging of pump filter.

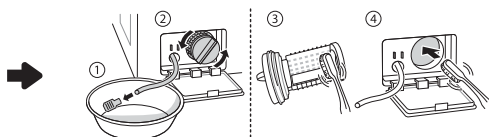

Clean the pump filter.

Water is not coming because water inlet valve filters are clogged or water inlet hoses are kinked.

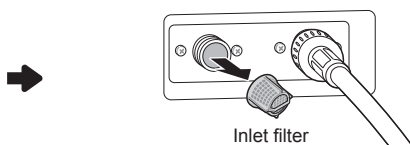

Clean the inlet valve filter or reinstall the water inlet hoses.

Water is not coming because too much detergent use.

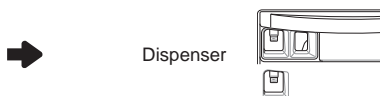

Clean the detergent dispenser drawer.

Laundry is hot or warm after finished washing because the inlet hoses are installed in reverse.

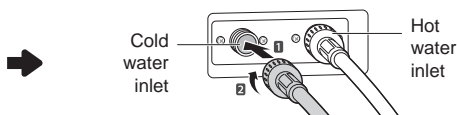

Reinstall the inlet hoses.

Water is not supplied because the water tap is not turned on. ➔

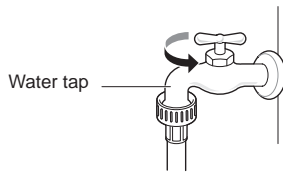

Turn on the water tap.

Leakage caused by improper installation of drain hose or clogged drain hose. ➔

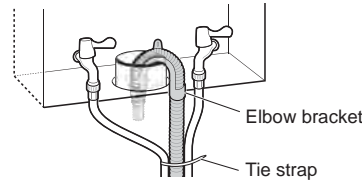

Reinstall the drain hose.

Leakage caused by improper installation of water inlet hose or using other brand inlet hoses. ➔

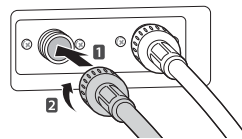

Reinstall the inlet hose.

No power problem caused by loose connection of power cord or electrical outlet problem. ➔

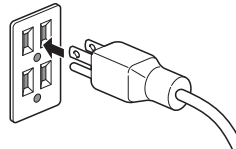

Reconnect the power cord or change the electrical outlet.

Service trips to deliver, pick up, install the product or for instruction on product use. The removal and reinstallation of the Product. ➔

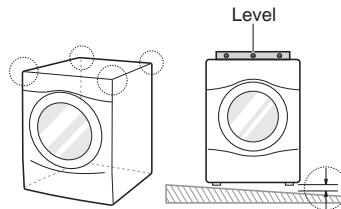

The warranty covers manufacturing defects only. Service resulting from improper Installation is not covered.

If all screws are not installed properly, it may cause excessive vibration (Pedestal model only). ➔

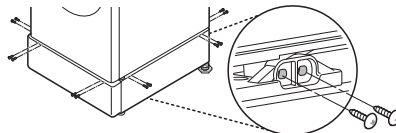

Install 4 screws at each corner (Total 16EA).

Water hammering (banging) noise when washing machine is filling with water. ➔

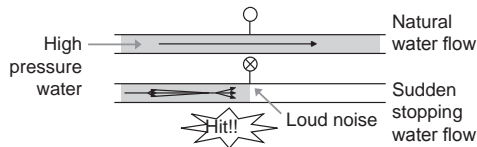

Adjust the water pressure by turning down the water valve by turning down the water tap in the home.

**The cost of repair or replacement under these excluded circumstances shall be borne by the consumer.**

TO OBTAIN WARRANTY SERVICE AND ADDITIONAL INFORMATION

For additional product information, visit the LG website at <http://www.lg.com>

For assistance using this product or to schedule service, contact LG Electronics at 1-800-984-6306.

For further assistance, write: LG Electronics, 201 James Record Road, Huntsville, Alabama 35813





# LG SIGNATURE

Customer Information Center

For inquires or comments,  
visit [www.lg.com](http://www.lg.com) or call:

1-800-984-6306 USA

# LG SIGNATURE

## OWNER'S MANUAL DRYER

Please read this owner's manual thoroughly before operating and keep it handy for reference at all times.

DLEX9500\*

DLGX9501\*



MFL67731093

# TABLE OF CONTENTS

## 3 IMPORTANT SAFETY INSTRUCTIONS

---

- 3 WHAT TO DO IF YOU SMELL GAS
- 4 BASIC SAFETY PRECAUTIONS
- 4 CALIFORNIA SAFE DRINKING WATER AND TOXIC ENFORCEMENT ACT
- 5 GROUNDING INSTRUCTIONS
- 5 SAFETY INSTRUCTIONS FOR INSTALLATION
- 6 SAFETY INSTRUCTIONS FOR STEAM FUNCTIONS
- 7 SAFETY INSTRUCTIONS FOR CONNECTING ELECTRICITY

## 8 TRANSMITTER MODULE INFORMATION

---

## 9 SPECIAL FEATURES

---

## 10 PRODUCT OVERVIEW

---

- 10 Parts
- 10 Accessories
- 11 Control Panel Features
- 12 Display

## 13 INSTALLATION

---

- 13 Installation Overview
- 14 Installation Location Requirements
- 14 Clearances
- 15 Clearances with Optional Pedestal Base
- 16 Leveling the Dryer
- 17 Reversing the Door
- 19 Installing the Side Vent Kit
- 20 Venting the Dryer
- 22 Connecting the Inlet Hose
- 23 Connecting Gas Dryers
- 25 Connecting Electric Dryers
- 30 Special Requirements for Manufactured or Mobile Homes
- 30 Final Installation Check
- 31 Installation Test (Duct Check)

## 33 OPERATION

---

- 33 Operating the Dryer
- 34 Cycle Guide
- 35 Sorting Loads
- 35 Loading the Dryer
- 35 Check the Lint Filter before Every Load
- 35 Storage Under the Lid
- 36 Using the Lid
- 37 Cycle Modifier Buttons
- 38 Special Functions
- 39 Custom Program
- 40 Steam Functions
- 40 Steam Cycle Guide

## 41 SMART APPLIANCE CONNECTIVITY

---

- 41 Connectivity Overview
- 41 Connectivity Setup
- 42 Smart ThinQ™

## 44 USING SMART DIAGNOSIS™

---

## 45 MAINTENANCE

---

- 45 Regular Cleaning

## 46 TROUBLESHOOTING

---

- 46 Before Calling for Service

## 49 SPECIFICATIONS

---

## 50 WARRANTY

---

# IMPORTANT SAFETY INSTRUCTIONS

## READ ALL INSTRUCTIONS BEFORE USE

### WARNING

For your safety, the information in this manual must be followed to minimize the risk of fire, explosion, or electric shock, or to prevent property damage, injury to persons, or death.

#### **Your safety and the safety of others is very important.**

We have provided many important safety messages in this manual and on your appliance. Always read and obey all safety messages.



This is the safety alert symbol.

This symbol alerts you to potential hazards that can kill or hurt you and others.

All safety messages will follow the safety alert symbol and either the word DANGER, WARNING, or CAUTION.

These words mean:

### DANGER

You will be killed or seriously injured if you don't immediately follow instructions.

### WARNING

You can be killed or seriously injured if you don't follow instructions.

### CAUTION

You may be slightly injured or cause damage to the product if you do not follow instructions.

All safety messages will tell you what the potential hazard is, tell you how to reduce the chance of injury, and tell you what can happen if the instructions are not followed.

- **Do not install a clothes dryer with flexible plastic venting materials. If flexible metal (foil type) duct is installed, it must be of a specific type identified by the appliance manufacturer as suitable for use with clothes dryers. Flexible venting materials are known to collapse, be easily crushed, and trap lint. These conditions will obstruct clothes dryer airflow and increase the risk of fire.**
- **Install the clothes dryer according to the manufacturer's instructions and local codes.**
- **Save these instructions.**



### WARNING

#### **FIRE OR EXPLOSION HAZARD**

Failure to follow safety warnings exactly could result in serious injury, death or property damage.

- Do not store or use gasoline or other flammable vapors and liquids in the vicinity of this or any other appliance.
- **WHAT TO DO IF YOU SMELL GAS**
  - Do not try to light any appliance.
  - Do not touch any electrical switch; do not use any phone in your building.
  - Clear the room, building or area of all occupants.
  - Immediately call your gas supplier from a neighbor's phone. Follow the gas supplier's instructions.
  - If you cannot reach your gas supplier, call the fire department.
- Installation and service must be performed by a qualified installer, service agency or the gas supplier.



# IMPORTANT SAFETY INSTRUCTIONS

## **READ ALL INSTRUCTIONS BEFORE USE**

### **⚠ WARNING**

For your safety, the information in this manual must be followed to minimize the risk of fire, explosion, or electric shock, or to prevent property damage, injury to persons, or death.

## **BASIC SAFETY PRECAUTIONS**

### **⚠ WARNING**

To reduce the risk of fire, electric shock, or injury to persons when using this appliance, follow basic precautions, including the following:

- Read all instructions before using the dryer.
- Before use, the dryer must be properly installed as described in this manual.
- **Do not place items exposed to cooking oils in your dryer. Items contaminated with cooking oils may contribute to a chemical reaction that could cause a load to catch fire.**
- Do not dry articles that have been previously cleaned in, washed in, soaked in, or spotted with gasoline, dry-cleaning solvents, or other flammable or explosive substances as they give off vapors that could ignite or explode.
- **Do not reach into the dryer if the drum or any other part is moving.**
- Do not repair or replace any part of the dryer or attempt any servicing unless specifically recommended in this owner's manual or in published user-repair instructions that you understand and have the skills to carry out.
- **Do not tamper with controls.**
- Before the dryer is removed from service or discarded, remove the door to the drying compartment.
- Do not allow children to play on or in the dryer. Close supervision of children is necessary when the dryer is used near children.
- Do not use fabric softeners or products to eliminate static unless recommended by the manufacturer of the fabric softener or product.
- **Do not use heat to dry articles containing foam rubber or similarly textured rubber-like materials.**
- Keep area around the exhaust opening and adjacent surrounding areas free from the accumulation of lint, dust, and dirt.
- The interior of the dryer and exhaust vent should be cleaned periodically by qualified service personnel.
- Do not install or store the dryer where it will be exposed to the weather.
- Always check the inside of the dryer for foreign objects.
- Clean lint screen before or after each load.
- **Do not store plastic, paper, or clothing that may burn or melt on top of the dryer during operation.**

## **CALIFORNIA SAFE DRINKING WATER AND TOXIC ENFORCEMENT ACT**

This act requires the governor of California to publish a list of substances known to the state to cause cancer, birth defects, or other reproductive harm and requires businesses to warn customers of potential exposure to such substances.

Gas appliances can cause minor exposure to four of these substances, namely benzene, carbon monoxide, formaldehyde, and soot, caused primarily by the incomplete combustion of natural gas or LP fuels.

Properly adjusted dryers will minimize incomplete combustion. Exposure to these substances can be minimized further by properly venting the dryer to the outdoors.

**⚠ WARNING:** This product contains chemicals known to the State of California to cause cancer and birth defects or other reproductive harm. ***Wash hands after handling.***

# IMPORTANT SAFETY INSTRUCTIONS

## READ ALL INSTRUCTIONS BEFORE USE

### WARNING

For your safety, the information in this manual must be followed to minimize the risk of fire, explosion, or electric shock, or to prevent property damage, injury to persons, or death.

### GROUNDING INSTRUCTIONS

This appliance must be grounded. In the event of malfunction or breakdown, grounding will reduce the risk of electric shock by providing a path of least resistance for electric current. This appliance must be equipped with a cord having an equipment-grounding conductor and a grounding plug. The plug must be plugged into an appropriate outlet that is properly installed and grounded in accordance with all local codes and ordinances.

Do not modify the plug provided with the appliance. If it will not fit the outlet, have a proper outlet installed by a qualified electrician. This appliance must be connected to a grounded metal, permanent wiring system or an equipment-grounding conductor must be run with the circuit conductors and connected to the equipment-grounding terminal or lead on the appliance. Electric shock can result if the dryer is not properly grounded.

### SAFETY INSTRUCTIONS FOR INSTALLATION

### WARNING

To reduce the risk of fire, electric shock, or injury to persons when using this appliance, follow basic precautions, including the following:

- **Properly ground dryer to conform with all governing codes and ordinances.** Follow details in the installation instructions. Electric shock can result if the dryer is not properly grounded.
- **Before use, the dryer must be properly installed** as described in this manual. Electric shock can result if the dryer is not properly grounded.
- **Install and store the dryer where it will not be exposed to temperatures below freezing or exposed to the weather.**
- **All repairs and servicing must be performed by an authorized servicer unless specifically recommended in this owner's manual. Use only authorized factory parts.** Failure to follow this warning can cause serious injury, fire, electric shock, or death.
- **To reduce the risk of electric shock, do not install the dryer in humid spaces.** Failure to follow this warning can cause serious injury, fire, electric shock, or death.
- **Connect to a properly rated, protected, and sized power circuit to avoid electrical overload.** Improper power circuit can melt, creating electric shock and/or fire hazard.
- **Remove all packing items and dispose of all shipping materials properly.** Failure to do so can result in death, explosion, fire, or burns.
- **Place dryer at least 18 inches above the floor for a garage installation.** Failure to do so can result in death, explosion, fire, or burns.
- **Keep all packaging from children.** Packaging material can be dangerous for children. There is a risk of suffocation.
- **Do not install near another source of heat such as a stove, cooking oven.** Failure to do so can cause deform, smoke and fire.
- **Do not place candles, smoking materials, or other flammables on top of the product.** Dripping wax, smoke, or fire can result.
- **Remove all protective vinyl film from the product.** Failure to do so can cause product damage, smoke or fire.

# IMPORTANT SAFETY INSTRUCTIONS

## READ ALL INSTRUCTIONS BEFORE USE

### WARNING

For your safety, the information in this manual must be followed to minimize the risk of fire, explosion, or electric shock, or to prevent property damage, injury to persons, or death.

## SAFETY INSTRUCTIONS FOR INSTALLATION

### WARNING

To reduce the risk of injury to persons, follow all industry recommended safety procedures including the use of long sleeved gloves and safety glasses. Failure to follow all of the safety warnings in this manual could result in property damage, injury to persons, or death.

Exhaust/Ducting:

- **Gas dryers MUST be exhausted to the outside.** Failure to follow these instructions can result in fire or death.
- **The dryer exhaust system must be exhausted to the outside of the dwelling. If the dryer is not exhausted outdoors, some fine lint and large amounts of moisture will be expelled into the laundry area.** An accumulation of lint in any area of the home can create a health and fire hazard.
- **Use only rigid, semi-rigid, or flexible metal 4-inch diameter ductwork inside the dryer cabinet or for exhausting to the outside. Use of plastic or other combustible ductwork can cause a fire.** Punctured ductwork can cause a fire if it collapses or becomes otherwise restricted in use or during installation.
- **Ductwork is not provided with the dryer, and you should obtain the necessary ductwork locally. The end cap should have hinged dampers to prevent backdraft when the dryer is not in use.** Failure to follow these instructions can result in fire or death.
- **The exhaust duct must be 4 inches (10.2 cm) in diameter with no obstructions. The exhaust duct should be kept as short as possible. Make sure to clean any old ducts before installing your new dryer.** Failure to follow these instructions can result in fire or death.
- **Rigid or semi-rigid metal ducting is recommended for use between the dryer and the wall. In special installations when it is impossible to make a connection with the above recommendations, a UL-listed flexible metal transition duct may be used between the dryer and wall connection only. The use of this ducting will affect drying time.** Failure to follow these instructions can result in fire or death.
- **DO NOT use sheet metal screws or other fasteners which extend into the duct that could catch lint and reduce the efficiency of the exhaust system.** Secure all joints with duct tape. For complete details, follow the Installation Instructions. Failure to follow these instructions can result in fire or death.

### WARNING

#### Fire Hazard

Failure to follow safety warnings exactly could result in serious injury, death or property damage.

Do not install a booster fan in the exhaust duct.

Install all clothes dryers in accordance with the installation instructions of the manufacturer of the dryer.

## SAFETY INSTRUCTIONS FOR STEAM FUNCTIONS

### WARNING

To reduce the risk of fire, electric shock, or injury to persons when using this appliance, follow basic precautions, including the following:

- **Do not open the dryer door during steam cycles.** Failure to follow these instructions can result in a burn hazard.
- **Do not dry articles that have been previously cleaned in, washed in, soaked in, or spotted with gasoline, dry-cleaning solvents, or other flammable or explosive substances as they give off vapors that could ignite or explode.** Failure to follow these instructions can result in fire or death.
- **Do not fill the steam feeder with gasoline, dry-cleaning solvents, or other flammable or explosive substances.** Failure to follow these instructions can result in fire or death.
- **Do not touch the steam nozzle in the drum during or after the steam cycle.** Failure to follow these instructions can result in a burn hazard.
- **Do not fill the steam feeder with hot water (over 86 °F/30 °C).** Failure to follow these instructions can result in a burn hazard.

# IMPORTANT SAFETY INSTRUCTIONS

## **READ ALL INSTRUCTIONS BEFORE USE**

### **⚠ WARNING**

For your safety, the information in this manual must be followed to minimize the risk of fire, explosion, or electric shock, or to prevent property damage, injury to persons, or death.

## **SAFETY INSTRUCTIONS FOR CONNECTING ELECTRICITY**

### **⚠ WARNING**

To reduce the risk of fire, electric shock, or injury to persons when using this appliance, follow basic precautions, including the following:

- **Do not, under any circumstances, cut or remove the ground prong from the power cord.** To prevent injury to persons or damage to the dryer, the electrical power cord must be plugged into a properly grounded outlet.
- **For personal safety, this dryer must be properly grounded.** Failure to do so can result in electric shock or injury.
- **Refer to the installation instructions in this manual for specific electrical requirements for your model.** Failure to follow these instructions can create an electric shock hazard and/or a fire hazard.
- **This dryer must be plugged into a properly grounded outlet. Electric shock can result if the dryer is not properly grounded. Have the wall outlet and circuit checked by a qualified electrician to make sure the outlet is properly grounded.** Failure to follow these instructions can create an electric shock hazard and/or a fire hazard.
- **The dryer should always be plugged into its own individual electrical outlet which has a voltage rating that matches the rating plate.** This provides the best performance and also prevents overloading house wiring circuits which could cause a fire hazard from overheated wires.
- **Never unplug your dryer by pulling on the power cord. Always grip plug firmly and pull straight out from the outlet.** The power cord can be damaged, resulting in a risk of fire and electric shock.
- **Repair or replace immediately all power cords that have become frayed or otherwise damaged. Do not use a cord that shows cracks or abrasion damage along its length or at either end.** The power cord can melt, creating an electric shock and/or fire hazard.
- **When installing or moving the dryer, be careful not to pinch, crush, or damage the power cord.** This will prevent injury and prevent damage to the dryer from fire and electric shock.

**SAVE THESE INSTRUCTIONS**

# TRANSMITTER MODULE INFORMATION

## Wireless LAN Module Specifications

Model	LCW-003
Frequency Range	2412 to 2462 MHz
Output Power (Max)	IEEE 802.11 b : 17.56 dBm IEEE 802.11 g : 25.53 dBm IEEE 802.11 n : 25.29 dBm

### FCC Notice (For transmitter module contained in this product)

This equipment has been tested and found to comply with the limits for a Class B digital device, pursuant to Part 15 of the FCC Rules. These limits are designed to provide reasonable protection against harmful interference in a residential installation. This equipment generates, uses, and can radiate radio frequency energy and, if not installed and used in accordance with the instructions, may cause harmful interference to radio communications. However, there is no guarantee that interference will not occur in a particular installation. If this equipment does cause harmful interference to radio or television reception, which can be determined by turning the equipment off and on, the user is encouraged to try to correct the interference by one or more of the following measures:

- Reorient or relocate the receiving antenna.
- Increase the separation between the equipment and the receiver.
- Connect the equipment to an outlet on a circuit different from that to which the receiver is connected.
- Consult the dealer or an experienced radio/TV technician for help.

This device complies with part 15 of the FCC Rules.

Operation is subject to the following two conditions:

- 1) This device may not cause harmful interference and
- 2) This device must accept any interference received, including interference that may cause undesired operation of the device.

Any changes or modifications in construction of this device which are not expressly approved by the party responsible for compliance could void the user's authority to operate the equipment.

### FCC RF Radiation Exposure Statement

This equipment complies with FCC radiation exposure limits set forth for an uncontrolled environment. This transmitter must not be co-located or operating in conjunction with any other antenna or transmitter. This equipment should be installed and operated with a minimum distance of 20 cm (7.8 inches) between the antenna and your body. Users must follow the specific operating instructions for satisfying RF exposure compliance.

### Open Source Software Notice Information

To obtain the source code under GPL, LGPL, MPL, and other open source licenses, that is contained in this product, please visit <http://opensource.lge.com>.

In addition to the source code, all referred license terms, warranty disclaimers and copyright notices are available for download.

LG Electronics will also provide open source code to you on CD-ROM for a charge covering the cost of performing such distribution (such as the cost of media, shipping, and handling) upon email request to [opensource@lge.com](mailto:opensource@lge.com). This offer is valid for three (3) years from the date on which you purchased the product.

## SPECIAL FEATURES

### EASY-TO-USE CONTROL PANEL

Rotate the cycle selector knob to select the desired dry cycle. Add cycle options or adjust settings with the touch of a button.

### EASY-ACCESS REVERSIBLE DOOR

The wide-opening door provides easy access for loading and unloading. The door hinge can be reversed to adjust for installation location.

### ULTRA-CAPACITY STAINLESS STEEL DRUM WITH DRUM LIGHT

The ultra-large stainless steel drum offers superior durability. The drum is equipped with a light that illuminates when the dryer door is opened and turns off when the door is closed.

### STEAM FUNCTIONS

LG's steam technology injects fabrics with a swirling jet of hot steam to refresh clothes. Simply select the STEAM FRESH™ cycle, or add a steam option to selected cycles.

### FLOW SENSE™ DUCT BLOCKAGE SENSING SYSTEM INDICATOR

The FLOW SENSE™ duct blockage sensing system detects and alerts you to restrictions in the installed household ductwork that reduce exhaust airflow through the dryer. If you see the alert: Clean or repair the ducts to remove the restrictions. Keep your ducts clean to help increase efficiency and reduce long drying times caused by blocked ducts.

### SMART THINQ™

**Remote Start** – Use a smart phone to control your appliance remotely. Also, it is possible to monitor your cycle operation so you know how much time is left in the cycle.

**Smart Grid** – Smart appliances can communicate with local utility companies that are equipped with Smart Grid equipment.

**Smart Message** – When the cycle is complete or the appliance has problems, you have the option of receiving push notifications on your smart phone.

**Download Cycle** – Download new and special cycles that are not included with the machine.

**Smart Diagnosis™** – Should you experience technical difficulty, your appliance has the capability of transmitting data by phone to the Customer Information Center to diagnosis the problem.

**Cycle Set** – This feature automatically sets cycle settings based on your laundry needs.

**Laundry Stats** – This feature provides the Flow Sense status and cycle use history for the machine.

**Energy Monitoring** – Your dryer energy usage is affected by the cycle and settings so you may see some changes in energy usage from one cycle to another.



**Protocol P154**  
**Sanitization Performance of**  
**Residential Clothes dryer**

# PRODUCT OVERVIEW

## PARTS AND ACCESSORIES

### Parts

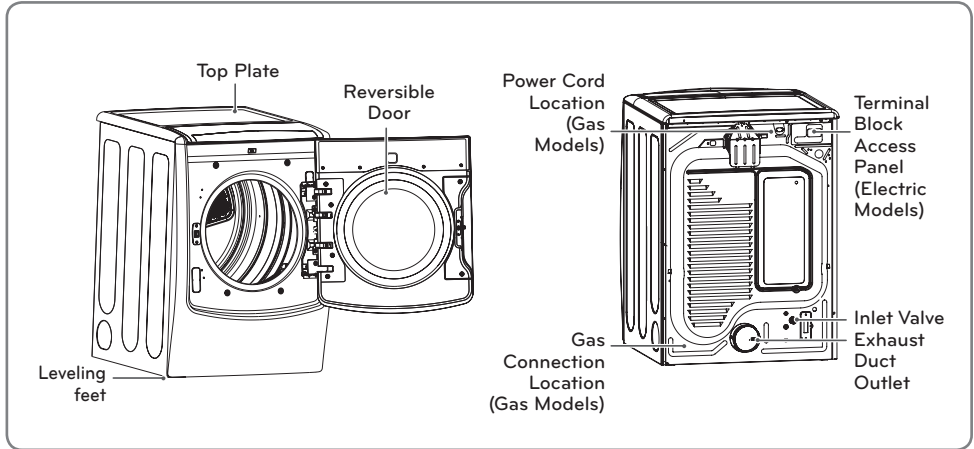

### Accessories

#### Included accessories



Y connector

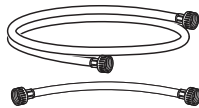

Hose

#### Optional accessories



Drying rack  
(AHB73109002)

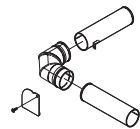

Side vent kit  
(sold separately)  
Kit No. 383EEL9001B

### NOTE

- Visit [www.lg.com](http://www.lg.com) to purchase accessories.
- Contact LG Customer Service at 1-800-984-6306 (1-888-542-2623 in Canada) if any accessories are missing.
- For your safety and for extended product life, use only authorized components. The manufacturer is not responsible for product malfunction or accidents caused by the use of separately purchased unauthorized components or parts.
- The images in this manual may be different from the actual components and accessories, which are subject to change by the manufacturer without prior notice for product improvement purposes.

## Control Panel Features

Following are instructions for starting and using your new dryer. Please refer to specific sections of this manual for more detailed information.

**⚠ WARNING :** To reduce the risk of fire, electric shock, or injury to persons, read this entire manual, including the Important Safety Instructions, before operating this dryer.

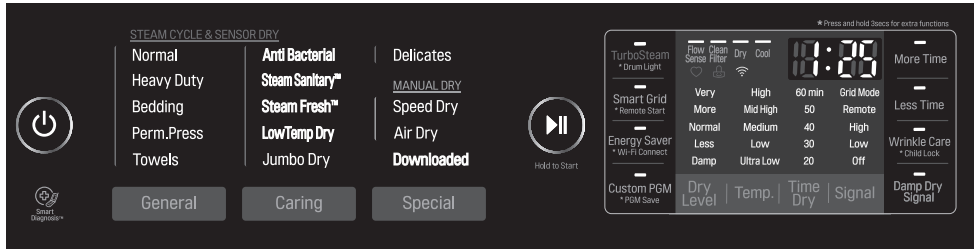

## Operation

Button	Description
	<p><b>POWER ON/OFF BUTTON</b></p> <ul style="list-style-type: none"> <li>- Press to turn the dryer ON. To turn the dryer off, press and hold more than 0.4 seconds.</li> <li><b>NOTE :</b> Pressing the ON/OFF button during a cycle will cancel that cycle and any load settings will be lost.</li> </ul>
	<p><b>CYCLE SELECTOR BUTTONS</b></p> <ul style="list-style-type: none"> <li>- Cycles are arranged according to the type of drying.</li> <li>- Press the buttons repeatedly to scroll through the cycles.</li> <li>- The cycle name lights when selected.</li> </ul>
	<p><b>START/PAUSE BUTTON</b></p> <ul style="list-style-type: none"> <li>- Press and hold this button more than 0.5 seconds to start the selected cycle. If the dryer is running, use this button to pause the cycle without losing the current settings.</li> <li><b>NOTE :</b> If you do not press the Start/Pause button to resume a cycle within four minutes, the dryer turns off automatically.</li> </ul>
	<p><b>MORE TIME/LESS TIME BUTTONS</b></p> <ul style="list-style-type: none"> <li>- To adjust the drying time, use these buttons with MANUAL DRY, TIME DRY, and STEAM FRESH™ cycles, as well as the REDUCE STATIC and EASY IRON options. Press the MORE TIME button to increase the selected manual cycle time by a minute; press LESS TIME to decrease the cycle time by a minute.</li> </ul>
	<p><b>CYCLE MODIFIER BUTTONS</b></p> <ul style="list-style-type: none"> <li>- Use these buttons to modify the default cycle settings for the selected cycle. The current settings are shown in the display. Press the button for that option to view and select other settings.</li> </ul>
	<p><b>OPTION BUTTONS</b></p> <ul style="list-style-type: none"> <li>- The OPTION buttons allow you to select additional cycle options. Certain buttons marked with an asterisk also allow you to activate special functions by pressing and holding the button for 3 seconds.</li> </ul>
<p>Steam Sanitary™</p> <p>Steam Fresh™</p>	<p><b>STEAM FUNCTIONS</b></p> <ul style="list-style-type: none"> <li>- LG's steam technology injects fabrics with a swirling jet of hot steam to refresh clothes, reduce static, and make ironing easier. Simply select the Steam Fresh™ cycle, or you can add a steam option to selected cycles.</li> </ul>



## Display

The display shows the settings, estimated time remaining, options, and status messages for your dryer. When the dryer is turned on, the light in the display will illuminate.

**⚠ WARNING :** To reduce the risk of fire, electric shock, or injury to persons, read this entire manual, including the Important Safety Instructions, before operating this dryer.

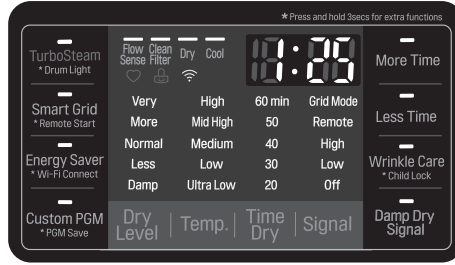

Display and Icons	Description
	<b>ESTIMATED TIME REMAINING</b> - When the Start button is pressed and held, the dryer will display the estimated (SENSOR DRY) or set time (TIME DRY) remaining, and begin tumbling. <b>NOTE :</b> The cycle time on SENSOR DRY cycles may fluctuate as the dryer recalculates drying time for optimal results
	<b>CYCLE COMPLETION INDICATOR WITH CHECK FILTER REMINDER</b> - This portion of the display shows which stage of the drying cycle is currently underway (CLEAN FILTER, DRY, or COOL).
	<b>CHILD LOCK INDICATOR</b> - When CHILD LOCK is set, the CHILD LOCK indicator will appear and all buttons are disabled except the POWER button. This prevents children from changing settings while the dryer is operating
	<b>CLEAN FILTER REMINDER</b> - The display will show CLEAN FILTER when the dryer is turned on as a reminder to clean the lint filter. It turns off when the Hold to Start button is pressed.
	<b>CUSTOM PROGRAM</b> - If you have a special combination of settings that you use frequently, you can save these settings as a CUSTOM PROGRAM.
	<b>FLOW SENSE™ DUCT BLOCKAGE SENSING SYSTEM INDICATOR</b> - The FLOW SENSE™ duct blockage sensing system detects and alerts you to blockages in the ductwork that reduce exhaust flow from the dryer. This improves operating efficiency and helps minimize service calls, saving you money.
	<b>WI-FI CONNECTION INDICATOR</b> - When the appliance is connected to the internet through a home Wi-Fi network, this indicator appears.

# INSTALLATION

## Installation Overview

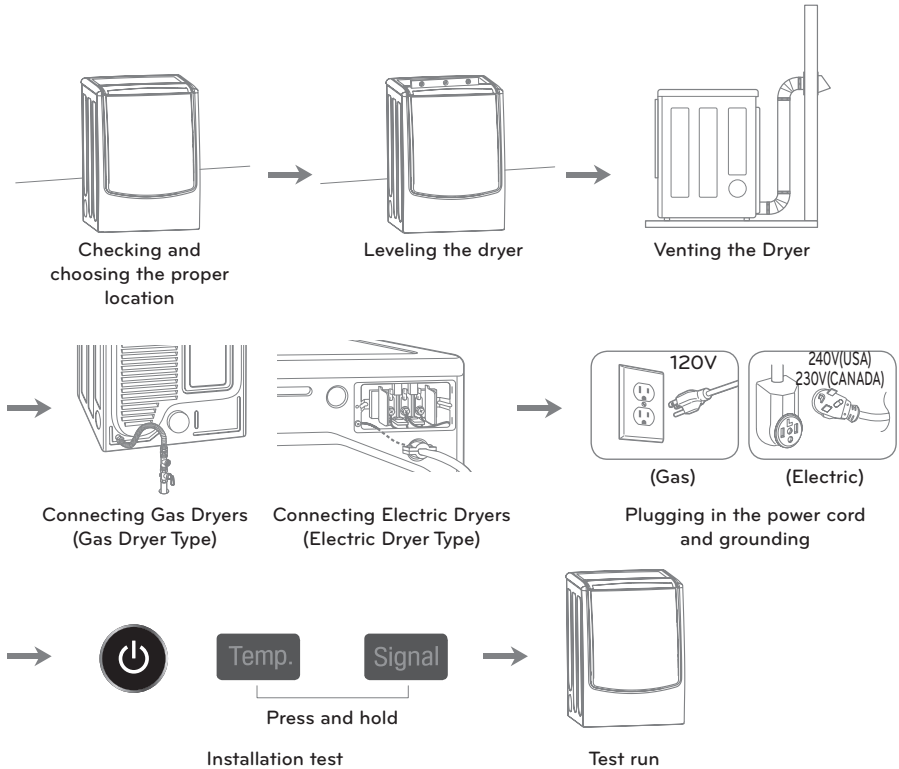

## Installation Location Requirements

### ⚠ WARNING

**Read all installation instructions completely before installing and operating your dryer!** It is important that you review this entire manual before installing and using your dryer. Detailed instructions concerning electrical connections, gas connections, and exhaust requirements are provided on the following pages.

- A location that allows for proper exhaust installation. A gas dryer must be exhausted to the outdoors. See **Venting the dryer**.
- A grounded electrical outlet located within 2 ft. (61 cm) of either side of the dryer. See **Connecting Electric Dryers**.
- A sturdy floor to support the total dryer weight of 200 lbs (90.7 kg). The combined weight of a companion appliance should also be considered.
- No other fuel-burning appliance can be installed in the same closet as a dryer.

Do not operate your dryer at temperatures below 45°F (7°C). At lower temperatures, the dryer might not shut off at the end of an automatic cycle. This can result in longer drying times. The dryer must not be installed or stored in an area where it will be exposed to water and/or weather. Check code requirements. Some codes limit, or do not permit, installation of the dryer in garages, closets, mobile homes or sleeping quarters. Contact your local building inspector.

### ! NOTE

- Floor must be level, with a maximum slope of 1 inch (2.5 cm) under entire dryer. Clothes may not tumble properly, and automatic sensor cycles may not operate correctly if dryer is not level.
- For a garage installation, you will need to place the dryer at least 18 inches (46 cm) above the floor. If using a pedestal, you will need 18 inches (46 cm) to the bottom of the dryer.

## Clearances

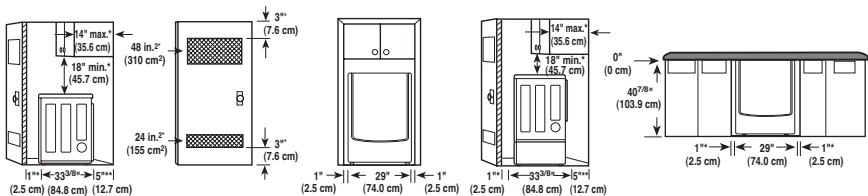

### INSTALLATION SPACING FOR RECESSED AREA OR CLOSET INSTALLATION

The following clearances are recommended for this dryer. Although this dryer has been tested for 1 inch (2.5 cm) clearance on the sides and rear, the recommended clearances should be considered for the following reasons:

- Additional clearance should be considered for ease of installation and servicing.
- Additional clearances might be required for wall, door and floor moldings.
- Additional clearance should be considered on all sides of the dryer to reduce noise transfer.
- For closet installation, with a door, minimum ventilation openings in the top and bottom of the door are required. Louvered doors with equivalent ventilation openings are acceptable.
- Companion appliance clearances should also be considered.

### ! NOTE

There should be at least a little space around the dryer (or any other appliance) to eliminate the transfer of vibration from one to the other. With enough vibration, the appliances will make noise or touch each other causing paint damage and making even more noise.

## Clearances with Optional Pedestal Base

### RECOMMENDED INSTALLATION SPACING FOR CABINET INSTALLATION

- For cabinet installation with a door, minimum ventilation openings in the top of the cabinet are required.

\*Required spacing

\*\*For side or bottom venting,  
2 inches (5.1 cm) spacing is allowed.

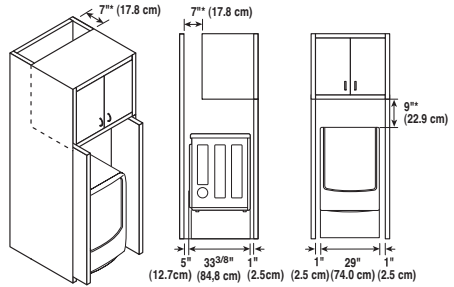

## Leveling the Dryer

### ⚠ WARNING

- **To reduce the risk of injury to persons, adhere to all industry recommended safety procedures including the use of long sleeved gloves and safety glasses.**

Failure to follow this warning can cause serious injury or death.

- **The appliances are heavy. Two or more people are required when installing the dryer.** Failure to follow this warning can cause serious injury or death.

To ensure that the dryer provides optimal drying performance, it must be level. To minimize vibration, noise, and unwanted movement, the floor must be a perfectly level, solid surface.

### ! NOTE

Adjust the leveling feet only as far as necessary to level the dryer. Extending the leveling feet more than necessary can cause the dryer to vibrate.

1. Position the dryer in the final location. Place a level across the top of the dryer.

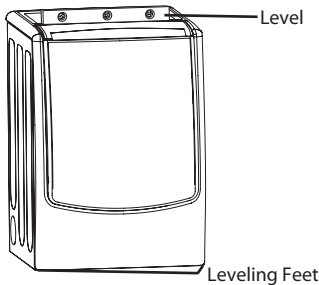

- All four leveling feet must rest solidly on the floor. Gently push on the top corners of the dryer to make sure that the dryer does not rock from corner to corner.

If you are installing the dryer on the optional pedestal, you must use the leveling feet on the pedestal to level the dryer. The dryer leveling feet should be fully retracted.

2. Use an adjustable wrench to turn the leveling feet. Turn clockwise to raise the dryer or counterclockwise to lower it. Raise or lower the leveling feet until the dryer is level from side to side and front to back.

Make sure that all four leveling feet are in firm contact with the floor.

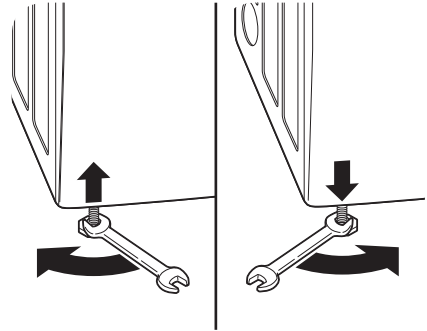

## Reversing the Door

### ⚠ WARNING

THE DRYER DOOR IS VERY LARGE AND HEAVY. Two or more people are required when reversing the door. Failure to follow the warnings below can result in damage to the dryer, property damage or injury to persons.

- To avoid damage to the dryer or the door, support the door with a stool or box that fits under the door, or have an assistant support the weight of the door.
- Always reverse the door BEFORE stacking the dryer on top of the washer.
- Avoid dropping the door to avoid damage to the door or the floor.

**Tools Needed:** flat blade screwdriver, Phillips screwdriver

### Before Starting

1. Unplug the machine or turn off the power supply at the main circuit before reversing the door. Open the dryer door.

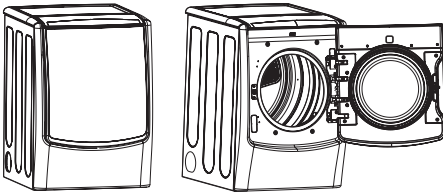

### ⚠ WARNING

Be sure to support the weight of the door before removing the hinge screws.

### Removing the Door

1. While supporting the door, remove the four hinge screws.
2. Carefully pull the door away from the cabinet to reveal the wire harness behind the hinge at the top. Depress the side lock tab to disconnect the wire harness connector. The twist tie and cap should prevent the wire harness from pulling back into the cabinet.
3. Remove the door from the cabinet cover. Set the door face down on a protected work surface.

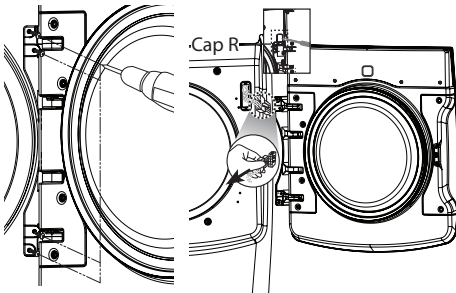

### Reversing the Door's Hinge and Strike

1. Remove the four screws on the right door frame (handle and strike), lift it off, and set the parts aside. (The two center strike screws are longer.)
2. Remove the four screws on the left door frame (hinge assembly).
3. Carefully lift out the hinge assembly, revealing the wire harness connector at the top of the hinge. Depress the center lock tab to disconnect the wire harness connector.
4. Rotate the hinge assembly 180 degrees and connect the wire harness to the connector in the bottom right side of the door.
5. Install the hinge assembly in the recess on the right side of the door, tucking the wire harness in the corner to make room. Insert and tighten the four screws.
6. Rotate the handle removed in step one 180 degrees and install it on the left side of the door using the two shorter screws. Use the longer screws to mount the door strike in the center.

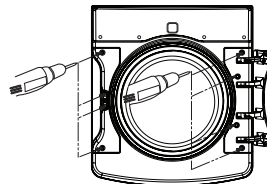
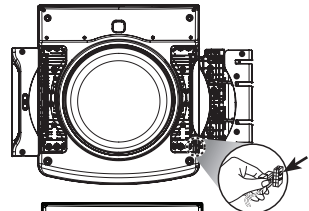
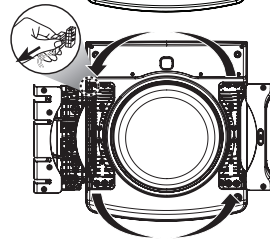
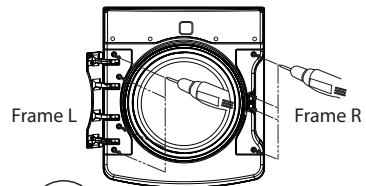

### Reversing the Cabinet Components

1. Remove the two screws and the latch assembly from the left side of the opening.
2. Rotate the latch assembly and remount it on the right side of the opening with the two screws.
3. Switch the two caps. Untie the twist tie and remove the small cap from the side of the wire harness on the top right of the cabinet. Make sure the wire harness does not slip back into the cabinet.
4. Remove the left cap by gently prying it up with a flat blade screwdriver, being careful not to scratch the paint. Disconnect the wire harness attached to the cap by pressing the tabs on either side.
5. Attach the left cap to the wire harness on the top right of the cabinet. Snap the cap into place.
6. Attach the twist tie and the small cap removed in step 1 to the side of the wire harness on the bottom left of the cabinet. The wire harness will be attached to the harness in the door.
7. Unscrew the four decorative screws from the left side of the cabinet and insert them into the matching holes on the right side of the cabinet.

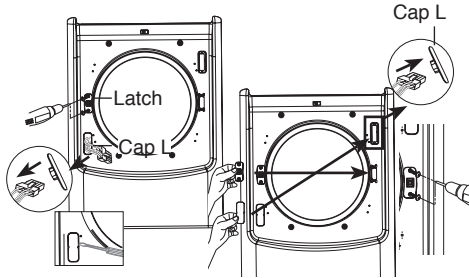

#### ⚠ WARNING

Be sure to support the weight of the door while inserting the hinge screws.

### Preparing to Remount the Door

1. While supporting the door, move the door into position with the hinge on the left side.
2. Connect the wire harness from the hinge to the connector on the lower left side of the cabinet.

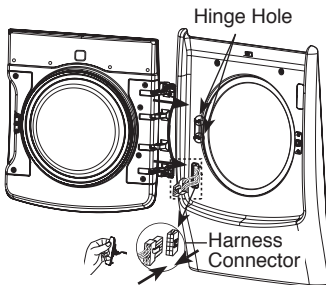

### Mounting the Door

1. Align the hinge with the mounting holes.
2. While supporting the door, fasten the four hinge screws.

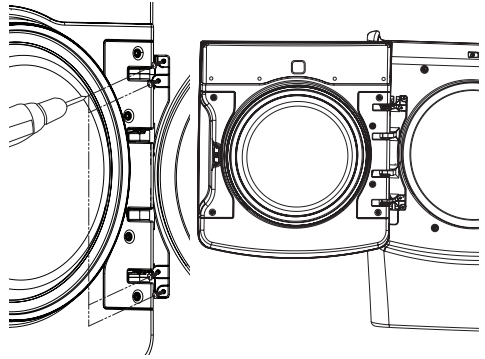

### Final Check

1. Check that the door closes and latches properly.

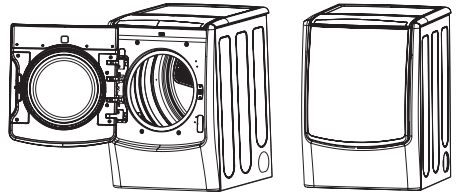

## Installing the Side Vent Kit

### ⚠️ WARNING

- Use a heavy metal vent.
- Do not use plastic or thin foil duct.
- Clean old ducts before installing this dryer.
- To reduce the risk of injury to persons, adhere to all industry recommended safety procedures including the use of long sleeved gloves and safety glasses.
- Failure to follow all of the safety warnings in this manual could result in property damage, injury to persons, or death.

Your new dryer is shipped to vent to the rear. It can also be configured to vent to the bottom or side (right-side venting is not available on gas models).

An adapter kit, part number **383EEL9001B**, may be purchased from an LG retailer. This kit contains the necessary duct components to change the dryer vent location.

1. Remove the rear exhaust duct retaining screw. Pull out the exhaust duct.

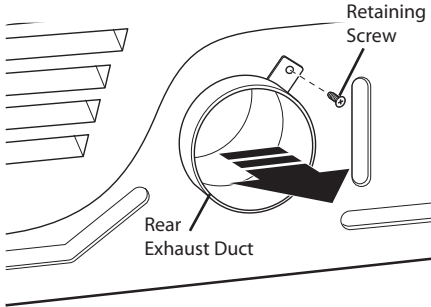

### OPTION 1: SIDE VENTING

2. Press the tabs on the knockout and carefully remove the knockout for the desired vent opening (right-side venting is not available on gas models). Press the adapter duct onto the blower housing and secure to the base of the dryer as shown.

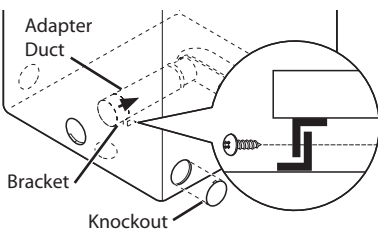

3. Preassemble a 4-inch (10.2 cm) elbow to the next 4-inch (10.2 cm) duct section, and secure all joints with duct tape. Be sure that the male end of the elbow faces AWAY from the dryer. Insert the elbow/duct assembly through the side opening and press it onto the adapter duct. Secure it in place with duct tape. Be sure that the male end of the duct protrudes 1½ inches (3.8 cm) to connect the remaining ductwork. Attach the cover plate to the back of the dryer with the included screw.

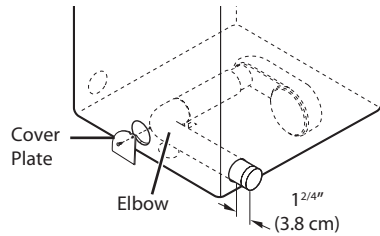

### OPTION 2: BOTTOM VENTING

2. Press the adapter duct onto the blower housing and secure it to the base of the dryer as shown.

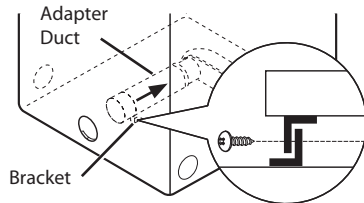

3. Insert the 4-inch (10.2 cm) elbow through the rear opening and press it onto the adapter duct. Be sure that the male end of the elbow faces down through the hole in the bottom of the dryer. Secure it in place with duct tape. Attach the cover plate to the back of the dryer with the included screw.

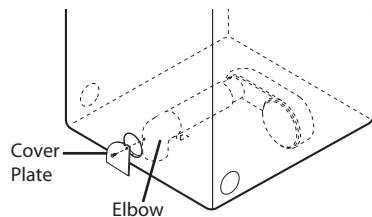



## Venting the Dryer

### WARNING

To reduce the risk of fire, electric shock, or injury to persons when using this appliance, follow basic precautions, including the following:

- **Do not crush or collapse ductwork.** Failure to follow these instructions can result in fire or death.
- **Do not allow ductwork to rest on or contact sharp objects.** Failure to follow these instructions can result in fire or death.
- **If connecting to existing ductwork, make sure it is suitable and clean before installing the dryer.** Failure to follow these instructions can result in fire or death.
- **Venting must conform to local building codes.** Failure to follow these instructions can result in fire or death.
- **Gas dryers MUST exhaust to the outdoors.** Failure to follow these instructions can result in fire or death.
- **Use only 4-inch (10.2 cm) rigid, semi-rigid, or flexible metal ductwork inside the dryer cabinet and for venting outside.** Failure to follow these instructions can result in fire or death.
- **To reduce the risk of fire, combustion, or accumulation of combustible gases, DO NOT exhaust dryer air into an enclosed and unventilated area, such as an attic, wall, ceiling, crawl space, chimney, gas vent, or concealed space of a building.** Failure to follow these instructions can result in fire or death.
- **To reduce the risk of fire, DO NOT exhaust the dryer with plastic or thin foil ducting.** Failure to follow these instructions can result in fire or death.
- **The exhaust duct must be 4 inches (10.2 cm) in diameter with no obstructions. The exhaust duct should be kept as short as possible. Make sure to clean any old ducts before installing your new dryer.** Failure to follow these instructions can result in fire or death.
- **Rigid or semirigid metal ducting is recommended for use between the dryer and the wall. In special installations when it is impossible to make a connection with the above recommendations, a UL-listed flexible metal transition duct may be used between the dryer and wall connection only. The use of this ducting will affect drying time.** Failure to follow these instructions can result in fire or death.
- **DO NOT use sheet metal screws or other fasteners which extend into the duct that could catch lint and reduce the efficiency of the exhaust system. Secure all joints with duct tape.** Failure to follow these instructions can result in fire or death.
- **To maximize operating results, please observe the duct length limitations noted in the chart on the next page.** Failure to follow these instructions can result in fire or death.
- **Ductwork is not provided with the dryer. You should obtain the necessary ductwork locally. The end cap should have hinged dampers to prevent backdraft when the dryer is not in use.** Failure to follow these instructions can result in fire or death.
- **The total length of flexible metal duct shall not exceed 8 ft. (2.4 m)**
- **In Canada, only those foil-type flexible ducts, if any, specifically identified for use with the appliance by the manufacturer shall be used.** In the United States, only those foil-type flexible ducts, if any, specifically identified for use with the appliance by the manufacturer and that comply with the Outline for Clothes Dryer Transition Duct, Subject 2158A, shall be used.

## Venting the Dryer (cont.)

### Ductwork

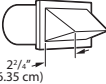
WALL CAP TYPE	NUMBER OF 90° ELBOWS	MAXIMUM LENGTH OF 4-INCH DIAMETER RIGID METAL DUCT
 4" (10.2 cm)	0	65 ft. (19.8 m)
	1	55 ft. (16.8 m)
	2	47 ft. (14.3 m)
	3	36 ft. (11.0 m)
	4	28 ft. (8.5 m)
Use only for short run installations  2 1/4" (6.35 cm)	0	55 ft. (16.8 m)
	1	47 ft. (14.3 m)
	2	41 ft. (12.5 m)
	3	30 ft. (9.1 m)
	4	22 ft. (6.7 m)

### CORRECT VENTING

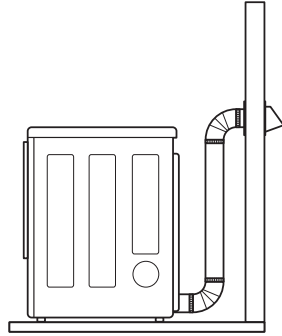

### INCORRECT VENTING

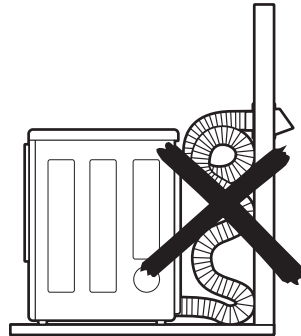

### NOTE

Deduct 6 ft. (1.8 m) for each additional elbow. Use of more than four 90° elbows is not recommended.

### ROUTING AND CONNECTING DUCTWORK

### NOTE

Follow the guidelines below to maximize drying performance and reduce lint buildup and condensation in the ductwork.

Ductwork and fittings are NOT included and must be purchased separately.

- Use 4-inch (10.2 cm) diameter rigid or semirigid metal ductwork.
- The exhaust duct run should be as short as possible.
- Use as few elbow joints as possible.
- The male end of each section of exhaust duct must point away from the dryer.
- Use duct tape on all duct joints.
- Insulate ductwork that runs through unheated areas in order to reduce condensation and lint buildup on duct surfaces.
- Failure to exhaust the dryer correctly will void the dryer's warranty.

## Connecting the Inlet Hose

The dryer must be connected to the cold water tap using the new water supply hose. Do not reuse old hoses.

### NOTE

- Water supply pressure must be between 20 psi and 120 psi (138–827 kPa).
- Do not strip or cross-thread when connecting the inlet hose to the valve.
- If the water supply pressure is more than 120 psi (827 kPa), a pressure reducing valve must be installed.
- Periodically check the condition of the hose and replace the hose if necessary.
- Replace inlet hoses after five years of use to reduce the risk of hose failure.
- Record hose installation or replacement dates on the hoses for future reference.

1. Check the rubber seal in the inlet hose. Two rubber seals are supplied with each inlet hose. They are used for preventing water leaks. Make sure the connection to the cold water tap is tight.

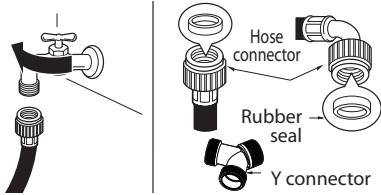

2. Check the installation type.

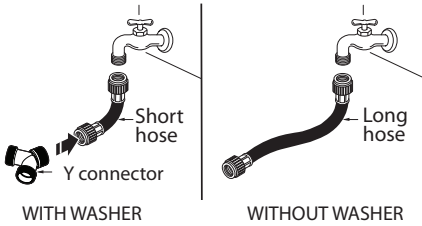

**Connect all water supply hoses tightly by hand and then tighten another 2/3 turn with pliers.**

**WITH WASHER: When connecting the dryer to the same faucet as a washer.**

- a. Shut off the cold water tap and remove the washer hose.
- b. Connect the short hose to the Y-connector using one of the rubber seals.
- c. Connect the other end of the short hose to the cold water faucet.
- d. Connect the long dryer hose to one side of the Y-connector and connect the washer hose to the other side.

**WITHOUT WASHER: If the dryer does not share the cold water tap with a washer.**

- a. Connect the straight end of the long hose to the cold water faucet.

### NOTE

- Before connecting the water line to the dryer, flush several gallons of water into a drain or bucket. This will help prevent foreign particles such as sand and scale from clogging the dryer inlet valve.
- Do not overtighten. Damage to the coupling can result.

3. Connect the hose to the dryer.

- Connect the water supply hose to the dryer inlet valve tightly by hand and then tighten another 2/3 turn with pliers. Make sure that there are no kinks in the hoses and that they are not crushed.

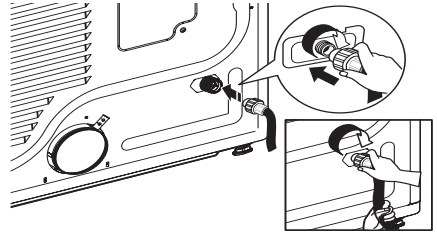

4. Turn on the cold water faucet.

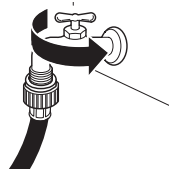

5. Check for leaks at the Y-connector (if used) and in all hoses.

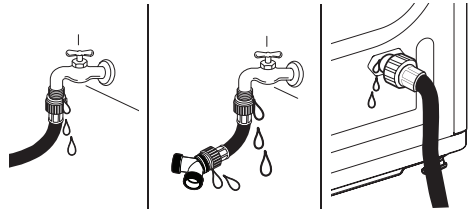

### NOTE

- If any leaks are found, shut off the water faucet, remove the hose and check the condition of the rubber seals.

## Connecting Gas Dryers

### WARNING

To reduce the risk of fire, electric shock, or injury to persons when using this appliance, follow basic precautions, including the following:

- **Gas supply requirements:**  
**As shipped from the factory, this dryer is configured for use with natural gas. It can be converted for use with LP (Liquefied Propane) gas. Gas pressure must not exceed 13 inches of water column.**
- **A qualified service or gas company technician must connect the dryer to the gas service.** Failure to follow this warning can result in fire, explosion, or death.
- **Isolate the dryer from the gas supply system by closing its individual manual shutoff valve during any pressure testing of the gas supply.** Failure to do so can result in fire, explosion, or death.
- **Supply line requirements:**  
**Your laundry room must have a rigid gas supply line to your dryer. In the United States, an individual manual shutoff valve MUST be installed within at least 6 ft. (1.8 m) of the dryer, in accordance with the National Fuel Gas Code ANSI Z223.1 or Canadian gas installation code CSA B149.1. A  $\frac{1}{8}$ -inch NPT pipe plug must be installed.** Failure to do so can result in fire, explosion, or death.
- **If using a rigid pipe, the rigid pipe should be  $\frac{1}{2}$ -inch IPS. If acceptable under local codes and ordinances and when acceptable to your gas supplier,  $\frac{3}{8}$ -inch approved tubing may be used where lengths are less than 20 ft. (6.1 m). Larger tubing should be used for lengths in excess of 20 ft. (6.1 m).** Failure to do so can result in fire, explosion, or death.
- **Connect the dryer to the type of gas shown on the nameplate.** Failure to do so can result in fire, explosion, or death.
- **To prevent contamination of the gas valve, purge the gas supply of air and sediment before connecting the gas supply to the dryer. Before tightening the connection between the gas supply and the dryer, purge remaining air until the odor of gas is detected.** Failure to do so can result in fire, explosion, or death.
- **DO NOT use an open flame to inspect for gas leaks. Use a noncorrosive leak-detection fluid.** Failure to do so can result in fire, explosion, or death.
- **Use only a new AGA- or CSA-certified gas supply line with flexible stainless steel connectors.** Failure to do so can result in fire, explosion, or death.
- **Securely tighten all gas connections.** Failure to do so can result in fire, explosion, or death.
- **DO NOT attempt any disassembly of the dryer; any disassembly requires the attention and tools of an authorized and qualified service person or company.** Failure to do so can result in fire, explosion, or death.
- **Use a pipe-joint compound that is insoluble in Liquefied Petroleum (LP) gas on all pipe threads.** Failure to do so can result in fire, explosion, or death.

### *Electrical requirements for gas models only*

### WARNING

To reduce the risk of fire, electric shock, or injury to persons when using this appliance, follow basic precautions, including the following:

- **Do not, under any circumstances, cut or remove the third (ground) prong from the power cord.** Failure to follow this warning can result in fire, explosion, or death.
- **For personal safety, this dryer must be properly grounded.** Failure to follow this warning can result in fire, explosion, or death.
- **This dryer must be plugged into a 60 Hz, 120 VAC, grounded outlet protected by a 15-ampere fuse or circuit breaker.** Failure to follow this warning can result in fire, explosion, or death.
- **Where a standard 2-prong wall outlet is encountered, it is your personal responsibility and obligation to have it replaced with a properly grounded 3-prong wall outlet.** Failure to follow this warning can result in fire, explosion, or death.

### WARNING ELECTRIC SHOCK HAZARD

Failure to follow safety warnings could result in serious injury or death.

This dryer is equipped with a three-prong grounding plug for protection against shock hazard and should be plugged directly into a properly grounded three-prong receptacle. Do not cut or remove the grounding prong from this plug.

## Connecting Gas Dryers (cont.)

### ⚠ WARNING

To reduce the risk of fire, electric shock, or injury to persons when using this appliance, follow basic precautions, including the following:

- **Installation and service must be performed by a qualified installer, service agency, or the gas supplier.** Failure to do so can result in fire, explosion, or death.
- **Use only a new stainless steel flexible connector and a new AGA-certified connector.** Failure to do so can result in fire, explosion, or death.
- **A gas shutoff valve must be installed within 6 ft. (1.8 m) of the dryer.** Failure to do so can result in fire, explosion, or death.
- **The dryer is configured for Natural Gas when shipped from the factory. Make sure that the dryer is equipped with the correct burner orifice for the type of gas being used (Natural Gas or Liquefied Petroleum).** Failure to do so can result in fire, explosion, or death.
- **If necessary, the correct orifice (For the LP orifice kit, order part number 383EEL3002D) should be installed by a qualified technician and the change should be noted on the dryer.** Failure to do so can result in fire, explosion, or death.
- **All connections must be in accordance with local codes and regulations.** Failure to do so can result in fire, explosion, or death.
- **Gas dryers MUST exhaust to the outdoors.** Failure to do so can result in fire, explosion, or death.

### Connecting the gas supply

1. Make sure that the gas supply to the laundry room is turned OFF. Confirm that the type of gas available in your laundry room is appropriate for the dryer. The dryer is prepared for Natural Gas with a  $\frac{3}{8}$ -inch NPT gas connection.
2. Remove the shipping cap from the gas connection at the back of the dryer. Be careful not to damage the threads of the gas connector when removing the shipping cap.
3. Connect the dryer to your laundry room's gas supply using a new flexible stainless steel connector with a  $\frac{3}{8}$ -inch NPT fitting.
4. Securely tighten all connections between the dryer and your laundry room's gas supply. Turn on your laundry room's gas supply and check all pipe connections (both internal and external) for gas leaks with a noncorrosive leak-detection fluid.

### Electrical connection

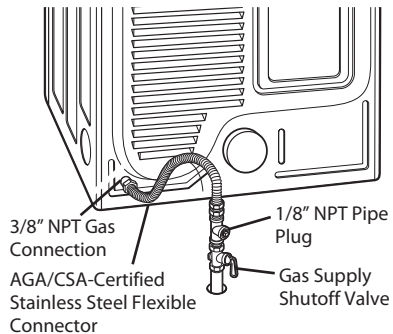
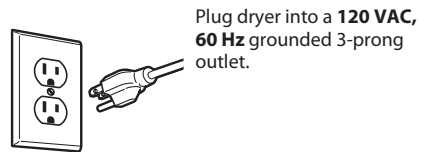

### High-altitude installations

The BTU rating of this dryer is AGA-certified for elevations below 10,000 feet.

If your gas dryer is being installed at an elevation above 10,000 feet, it must be derated by a qualified technician or gas supplier.

## Connecting Electric Dryers

### ⚠️ WARNING

To help prevent fire, electric shock, serious injury, or death, the wiring and grounding must conform to the latest edition of the National Electrical Code, ANSI/NFPA 70 and all applicable local regulations. Please contact a qualified electrician to check your home's wiring and fuses to ensure that your home has adequate electrical power to operate the dryer.

#### *Electrical requirements for electric models only*

### ⚠️ WARNING

To reduce the risk of fire, electric shock, or injury to persons when using this appliance, follow basic precautions, including the following:

- **This dryer must be connected to a grounded metal, permanent wiring system, or an equipment-grounding conductor must be run with the circuit conductors and connected to the equipment-grounding terminal or lead on the dryer.** Failure to do so can result in fire, explosion, or death.
- **The dryer has its own terminal block that must be connected to a separate 240 VAC, 60-Hertz, single-phase circuit, fused at 30 amperes (the circuit must be fused on both sides of the line).** ELECTRICAL SERVICE FOR THE DRYER SHOULD BE OF THE MAXIMUM RATE VOLTAGE LISTED ON THE NAMEPLATE. DO NOT CONNECT THE DRYER TO 110-, 115-, OR 120-VOLT CIRCUIT. Failure to follow these instructions can result in fire, explosion, or death.
- **If branch circuit to dryer is 15 ft. (4.5 m) or less in length, use UL (Underwriters Laboratories) listed No.-10 AWG wire (copper wire only), or as required by local codes. If over 15 ft. (4.5 m), use UL-listed No.-8 AWG wire (copper wire only), or as required by local codes. Allow sufficient slack in wiring so dryer can be moved from its normal location when necessary.** Failure to do so can result in fire, explosion, or death.
- **The power cord (pigtail) connection between the wall receptacle and the dryer terminal block IS NOT supplied with the dryer. The type of pigtail and gauge of wire must conform to local codes and with instructions on the following pages.** Failure to follow these instructions can result in fire, explosion, or death.
- **A 4-wire connection is required for all mobile and manufactured home installations, as well as all new construction after January 1, 1996. A 4-wire connection must be used where local codes do not permit grounding through the neutral wire.** Failure to do so can result in fire, explosion, or death.

### ⚠️ WARNING

To reduce the risk of fire, electric shock, or injury to persons when using this appliance, follow basic precautions, including the following:

- **Do not modify the plug and internal wire provided with the dryer.**
- **The dryer should be connected to a 4-hole outlet.**
- **If it does not fit the outlet, a proper outlet will need to be installed by a qualified electrician.**

### ⚠️ WARNING

To reduce the risk of fire, electric shock, or injury to persons when using this appliance, follow basic precautions, including the following:

- **Any installation in a manufactured or mobile home must comply with the Manufactured Home Construction and Safety Standards Title 24 CFR, Part 3280 or Standard CAN/ CSA Z240 MH and local codes and ordinances.**
- **A 4-wire connection is required for all mobile and manufactured home installations, as well as all new construction after January 1, 1996.** Failure to do so can result in fire, explosion, or death.

## Connecting Electric Dryers (cont.)

### USA only

#### **⚠ WARNING**

• **Connect the power cord to the terminal block. Connect each power cord wire to the terminal block screw that has the same colored wire. For example, connect the black power cord wire to the terminal block screw with the black wire. Failure to follow these instructions may result in a short, overload, fire or death.**

• **Grounding through the neutral conductor is prohibited for: (1) new branch-circuit installations, (2) mobile homes, (3) recreational vehicles, and (4) areas where local codes prohibit grounding through the neutral conductor.**



**Four-wire connection for electric dryers: Power cord**

• A 4-wire connection is required for all mobile and manufactured home installations, as well as all new construction after January 1, 1996.

• A UL-listed strain relief is required.

1. Remove the terminal block access cover on the upper back of the dryer. Install a UL-listed strain relief into the power cord through-hole; then thread a UL-listed, **30 A, 240 V, 4-wire, #10 AWG-minimum copper** conductor power cord through the strain relief.

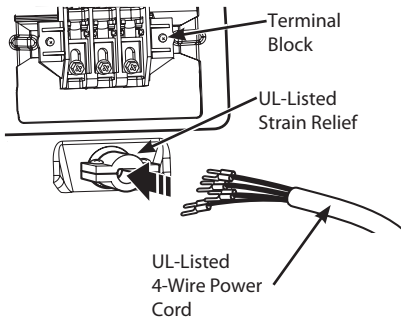

• **Use a 30 A, 240 V, UL-listed power cord with #10 AWG-minimum copper** conductor and closed loop or forked terminals with upturned ends.

2. Transfer the dryer's ground wire from behind the green ground screw to the center screw of the terminal block. Attach the two hot leads of the power cord to the outer terminal block screws. Attach the white neutral wire to the center terminal block screw. Attach the power cord ground wire to the green ground screw. **TIGHTEN ALL SCREWS SECURELY.** Reinstall the terminal block access cover.

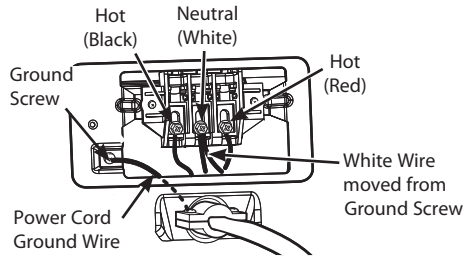

## Connecting Electric Dryers (cont.)

### USA only

#### ⚠ WARNING

• **Connect the power cord to the terminal block. Connect each power cord wire to the terminal block screw that has the same colored wire. For example, connect the black power cord wire to the terminal block screw with the black wire.**

**Failure to follow these instructions may result in a short, overload, fire or death.**

• **Grounding through the neutral conductor is prohibited for: (1) new branch-circuit installations, (2) mobile homes, (3) recreational vehicles, and (4) areas where local codes prohibit grounding through the neutral conductor.**

#### *Four-wire connection for electric dryers: Direct wire*

• A 4-wire connection is required for all mobile and manufactured home installations, as well as all new construction after January 1, 1996.

• A UL-listed strain relief is required.

1. Remove 5 inches (12.7 cm) of the outer covering from the wire. Remove 5 inches of insulation from the ground wire. Cut off approximately 1½ inches (3.8 cm) from the other three wires and strip 1 inch (2.5 cm) insulation from each wire. Bend the ends of the three shorter wires into a hook shape.

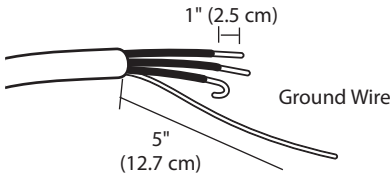

2. Remove the terminal block access cover on the upper back of the dryer. Install a UL-listed strain relief into the power cord through-hole; then thread the power cable prepared in Step 1 through the strain relief.

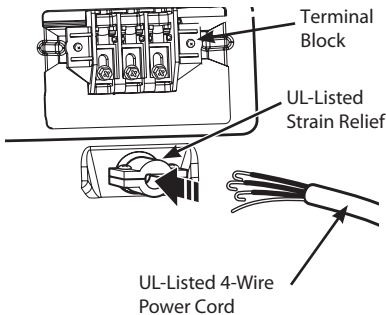

- Use UL-listed **4-wire #10 AWG-minimum copper** conductor cable.
  - Allow at least 5 ft. (1.5 m) length to allow for removal and reinstallation of the dryer.
3. Transfer the dryer's ground wire from behind the green ground screw to the center screw of the terminal block. Attach the two hot leads of the power cable to the outer terminal block screws. Attach the white neutral wire to the center terminal block screw. Attach the power cable ground wire to the green ground screw. **TIGHTEN ALL SCREWS SECURELY.** Reinstall the terminal block access cover.

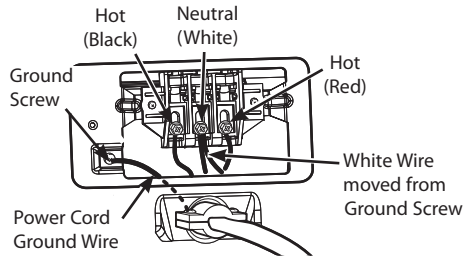



## Connecting Electric Dryers (cont.)

### USA only

#### **⚠ WARNING**

• **Connect the power cord to the terminal block. Connect each power cord wire to the terminal block screw that has the same colored wire. For example, connect the black power cord wire to the terminal block screw with the black wire. Failure to follow these instructions may result in a short, overload, fire or death.**

• **Grounding through the neutral conductor is prohibited for: (1) new branch-circuit installations, (2) mobile homes, (3) recreational vehicles, and (4) areas where local codes prohibit grounding through the neutral conductor.**



**Three-wire connection for electric dryers: Power cord**

• A 3-wire connection is NOT permitted on new construction after January 1, 1996.

• A UL-listed strain relief is required.

1. Remove the terminal block access cover on the upper back of the dryer. Install a UL-listed strain relief into the power cord through-hole; then thread a UL-listed, **30 A, 240 V, 3-wire, #10 AWG-minimum copper** conductor power cord through the strain relief.

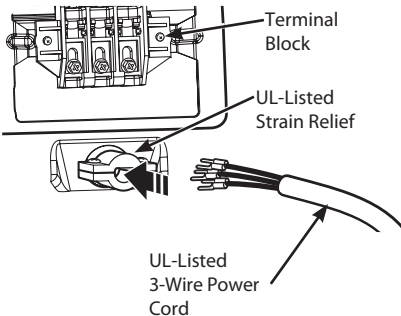

• Use a **30 A, 240 V, UL-listed power cord with #10 AWG-minimum copper** conductor and closed loop or forked terminals with upturned ends.

2. Attach the two hot leads of the power cord to the outer terminal block screws. Attach the neutral wire to the center terminal block screw. Connect the external ground (if required by local codes) to the green ground screw. **TIGHTEN ALL SCREWS SECURELY.** Reinstall the terminal block access cover.

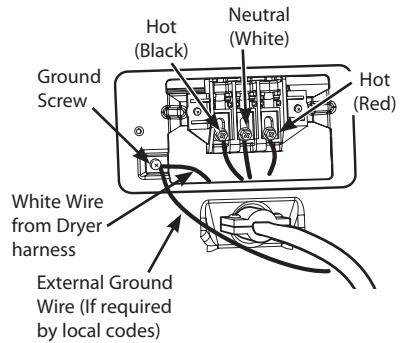

## Connecting Electric Dryers (cont.)

### USA only

#### **⚠️ WARNING**

• **Connect the power cord to the terminal block. Connect each power cord wire to the terminal block screw that has the same colored wire. For example, connect the black power cord wire to the terminal block screw with the black wire. Failure to follow these instructions may result in a short, overload, fire or death.**

• **Grounding through the neutral conductor is prohibited for: (1) new branch-circuit installations, (2) mobile homes, (3) recreational vehicles, and (4) areas where local codes prohibit grounding through the neutral conductor.**

#### **Three-wire connection for electric dryers: Direct wire**

- A 3-wire connection is NOT permitted on new construction after January 1, 1996.
  - A UL-listed strain relief is required.
1. Remove 3½ inches (8.9 cm) of the outer covering from the wire. Strip 1 inch (2.5 cm) insulation from each wire. Bend the ends of the three wires into a hook shape.

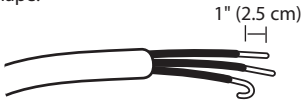

2. Remove the terminal block access cover on the upper back of the dryer. Install a UL-listed strain relief into the power cord through-hole; then thread the power cable prepared in Step 1 through the strain relief.

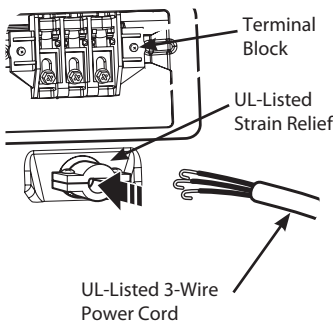

- Use UL-listed **3-wire #10 AWG-minimum copper** conductor cable.
  - Allow at least 5 ft. (1.5 m) length to allow for removal and reinstallation of the dryer.
3. Attach the two hot leads of the power cord to the outer terminal block screws. Attach the neutral wire to the center terminal block screw. Connect the external ground (if required by local codes) to the green ground screw. **TIGHTEN ALL SCREWS SECURELY.** Reinstall the terminal block access cover.

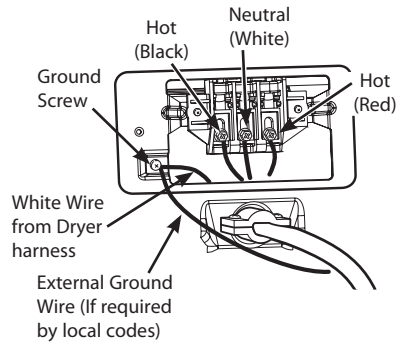

## Special Requirements for Manufactured or Mobile Homes

Any installation in a manufactured or mobile home must comply with the Manufactured Home Construction and Safety Standards Title 24 CFR, Part 3280 or Standard CAN/CSA Z240 MH and local codes and ordinances. If you are uncertain whether your proposed installation will comply with these standards, please contact a service and installation professional for assistance.

- A gas dryer must be permanently attached to the floor.
- The electrical connection for an electric dryer must be a 4-wire connection. More detailed information concerning the electrical connection is provided in the section Connecting Electric Dryers.
- To reduce the risk of combustion and fire, the dryer must be vented to the outside.
- DO NOT vent the dryer under a manufactured home or mobile home.
- Electric dryers may be vented to the outside using the back, left, right, or bottom panel.
- Gas dryers may be vented to the outside using the back, left, or bottom panel. Gas dryers may not be vented to the outside using the right side panel because of the burner housing.
- The dryer exhaust duct must be affixed securely to the manufactured or mobile home structure, and the exhaust duct must be made of a material that will resist fire and combustion. It is recommended that you use a rigid, semi-rigid, or flexible metal duct.
- DO NOT connect the dryer exhaust duct to any other duct, vent, chimney, or other exhaust duct.
- Make sure the dryer has adequate access to outside fresh air to ensure proper operation. The opening for outside fresh air must be at least 25 in<sup>2</sup> (163 cm<sup>2</sup>).
- It is important that the clearance of the duct from any combustible construction be at least 2 inches (5 cm), and when venting the dryer to the outdoors, the dryer can be installed with a clearance of 1 inch (2.5 cm) at the sides and back of the dryer.
- Please be aware that venting materials are not supplied with the dryer. You should obtain the venting materials necessary for proper installation.

## Final Installation Check

Once you have completed the installation of the dryer and it is in its final location, confirm proper operation with the following tests and the Installation Test (Duct Check) on the following page.

### Testing Dryer Heating

#### GAS MODELS

Close the dryer door, press the ON/OFF button to turn the dryer on, and start the dryer on a heat setting. When the dryer starts, the igniter should ignite the main burner.

#### NOTE

If all air is not purged from the gas line, the gas igniter may turn off before the main burner ignites. If this happens, the igniter will reattempt gas ignition after approximately two minutes.

#### ELECTRIC MODELS

Close the dryer door, press the ON/OFF button to turn the dryer on, and start the dryer on a heat setting. The exhaust air should be warm after the dryer has been operating for 3 minutes.

#### Checking Airflow

Effective dryer operation requires proper airflow. The adequacy of the airflow can be measured by evaluating the static pressure. Static pressure in the exhaust duct can be measured with a manometer, placed on the exhaust duct approximately 2 ft. (60.9 cm) from the dryer. Static pressure in the exhaust duct should not exceed 0.6 inches (1.5 cm). The dryer should be checked while the dryer is running with no load.

#### Checking Levelness

Once the dryer is in its final location, recheck the dryer to be sure it is level. Make sure it is level from front to back and side to side, and that all four leveling feet are firmly on the floor.

## Installation Test (Duct Check)

Once you have completed the installation of the dryer, use this test to make sure the condition of the exhaust system is adequate for proper operation of the dryer. This test should be performed to alert you to any serious problems in the exhaust system of your home.

- Your dryer features FLOW SENSE™, an innovative sensing system that automatically detects blockages and restrictions in dryer ductwork. Keeping ductwork clean of lint buildup and free of restrictions allows clothes to dry faster and reduces energy use.

### NOTE

The dryer should be cool before starting this test. If the dryer was warmed up during installation, run the AIR DRY cycle for a few minutes to reduce the interior temperature.

### To activate the Installation test:

- Remove the drying literature, and then close the door.**

Do not load anything in the drum for this test, as it may affect the accuracy of the results.

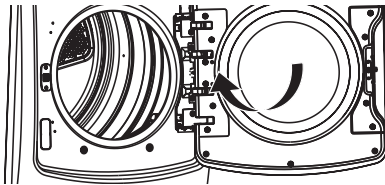

- After you are pressed of Power button, you will press and hold the Temp. and Signal buttons in 0.5 seconds.**

This button sequence activates the installation test. The code **1n5** will display if the activation is successful.

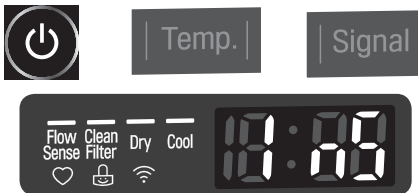

- Press and hold the Start button.**

The dryer will start the test, which will last about two minutes. The heat will be turned on and the temperatures in the drum will be measured.



- Check the display for results.**

During the test cycle, monitor the FLOW SENSE™ display on the control panel. If the Flow Sense indicator text lights up, the exhaust system is restricted. If the indicator text remains dark, the exhaust system is adequate.

Other problems may also be shown with error codes. Refer to the next page for error code details and solutions.



DARK:  
OK



LIGHTED:  
RESTRICTED

Have the system checked immediately, as performance will be poor.

- End of cycle.**

At the end of the test cycle, **End** will display. The test cycle will end and the dryer will shut off automatically after a short delay.



## Installation Test (Duct Check) (cont.)

- Check the Error Code before you call for service

Error Code	Possible Causes	Solutions
<b>tE1 or tE2</b>	• Temperature sensor failure	• Turn off the dryer and call for service.
<b>HS</b>	• Humidity Sensor failure.	• Turn off the dryer and call for service.
<b>PS or PF or nP</b>	<ul style="list-style-type: none"> <li>• Electric dryer power cord is not connected correctly, or house power supply is incorrect.</li> <li>• House fuse is blown, circuit breaker has tripped, or power outage has occurred.</li> </ul>	<ul style="list-style-type: none"> <li>• Check the power supply or the connection of power cord to the terminal block. Refer to the <b>Connecting electric dryers</b> section of this manual for complete instructions.</li> <li>• Reset circuit breaker or replace fuse. Do not increase the fuse capacity. If the problem is a circuit overload, have it corrected by a qualified electrician.</li> </ul>

### • Check the duct condition

If the FLOW SENSE™ LED is turned on, check the exhaust system for restrictions and damage. Repair or replace the exhaust system as needed.

#### NOTE

When the dryer is first installed, this test should be performed to alert you to any existing problems with the exhaust duct in your home. However, since the test performed during normal operation provides more accurate information on the condition of the exhaust duct than does the installation test, the number of bars displayed during the two tests may not be the same.

Do not interrupt the test cycle, as this could result in inaccurate results.

Even if no bars are displayed during the test cycle, some restrictions may still be present in the exhaust system. Refer to the Venting the Dryer section of this manual for complete exhaust system and venting requirements.

Your dryer features Flow Sense™, an innovative sensing system that automatically detects blockages and restrictions in dryer ductwork. Keeping ductwork clean of lint buildup and free of restrictions allows clothes to dry faster and reduces energy use.

### Restricted or Blocked Airflow



Avoid long runs or runs with multiple elbows or bends.

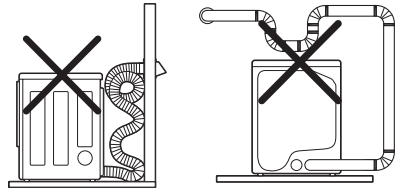

Excess or crushed transition duct

Too many elbows or exhaust too long

Check for blockages and lint buildup.

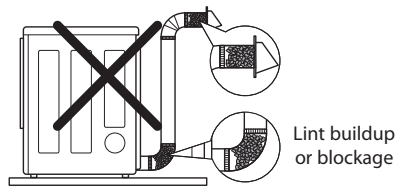

Lint buildup or blockage

Make sure the ductwork is not crushed or restricted.

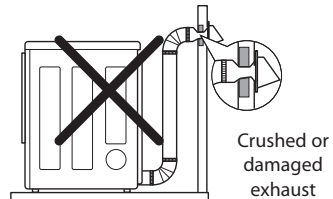

Crushed or damaged exhaust

# OPERATION

## Operating the Dryer

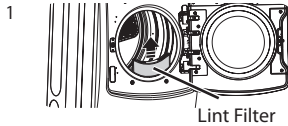

### CLEAN THE LINT FILTER

If the lint filter has not already been cleaned, lift out the filter and remove the lint from the last load. This will help ensure the fastest and most efficient drying performance.

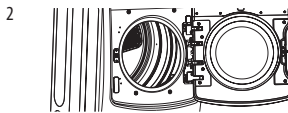

### LOAD THE DRYER

Load the dryer with the wet laundry from the washer. If the load is extra large, you may need to divide it into smaller loads for proper performance and fabric care.



### TURN ON THE DRYER

Press the POWER button to turn on the dryer. The cycle LEDs illuminate and a signal sounds, if turned on. Refer to page 11.

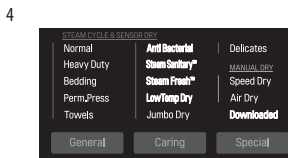

### SELECT A CYCLE

Press the cycle selector buttons repeatedly until the desired cycle is selected. The preset temperature, dry level, and option settings for that cycle will be shown. Refer to page 34. Default settings for the selected cycle can now be changed if desired. This can be done using the cycle modifier buttons as shown on page 37. Cycle options can be added using the option buttons as shown on page 37-40.

### NOTE

Not all options or modifiers are available on all cycles. A different chime will sound and the LED will not come on if the selection is not allowed.



### BEGIN CYCLE

Press and hold the Start button to begin the cycle. The cycle can be paused at any time either by opening the door or by pressing the Start button. If the cycle is not restarted within 4 minutes, the dryer will shut off and the cycle settings will be lost.





























### END OF CYCLE

When the cycle is finished, the chime will sound if it is set. Remove your clothing from the dryer immediately to reduce wrinkling. If WRINKLE CARE is selected, the dryer will tumble briefly every few minutes to help prevent wrinkles from setting in the clothes.

## Cycle Guide

 = default setting

 = allowable option

Cycle	Fabric Type	Dry Level	Temperature	Time	More Time/ Less Time	Wrinkle Care	Turbo Steam	Damp Dry Signal	Energy Saver
Steam Fresh™	comforters, shirts, trousers (except especially delicate fabrics)	Off	Mid High	10					
			Adjustable	Adjustable					
Steam Sanitary™	comforters, bedding, children's clothing	Off	High	31					
Anti Bacterial	Do not use this cycle with delicate fabrics.	Very	High	1:10					
LowTemp Dry	Only normal / towels fabric type (Max 3lb)	Normal	High	50					
		Adjustable							
Bedding	comforters, pillows, shirts	Normal	Medium	55					
		Adjustable							
Heavy Duty	jeans, heavyweight items	Adjustable	High	54					
Normal	work clothes, corduroys, etc.	Normal	Medium	41					
		Adjustable							
Jumbo Dry	comforters, pillows, shirt	Normal	Medium	1:25					
		Adjustable							
Perm. Press	permanent press, synthetic items	Normal	Low	32					
		Adjustable							
Delicates	lingerie, sheets, blouses	Normal	Low	28					
		Adjustable							
Towels	denim, towels, heavy cottons	Normal	Mid High	55					
		Adjustable							
Speed Dry	For small loads with short drying times	Off	High	25					
			Adjustable	Adjustable					
Air Dry	For items that require heat-free drying such as plastics or rubber	Off	Off	30					
			Adjustable						

### Sensor Dry Cycles

Sensor Dry cycles utilize LG's unique dual sensor system to detect and compare the moisture level in clothes and in the air and adjust the drying time as needed to ensure superior results. The dryer automatically sets the dryness level and temperature at the recommended setting for each cycle. The estimated time remaining will be shown in the display.

### LowTemp Dry

This cycle can save energy over the Normal cycle, depending on the load size. It may be necessary to adjust the Dryness Level to achieve the desired amount of drying.

### NOTE

To protect your garments not every dryness level, temperature, or option is available with every cycle. See the Cycle Guide for details.

### Manual Dry Cycles

Use Manual Dry cycles to select a specific amount of drying time and a drying temperature. When a Manual Dry cycle is selected, the ESTIMATED TIME REMAINING display shows the actual time remaining in your cycle. You can change the actual time in the cycle by pressing MORE TIME or LESS TIME.

 CERTIFIED BY NSF/P154

NSF International (formerly the National Sanitation Foundation), certifies that the **Anti Bacterial** cycle reduces 99.9% of bacteria on laundry, and none of the bacteria will carry over onto the next laundry load.

- The default settings for the **Anti Bacterial** cycle are **High** temperature and **Very Dry**.

These default settings cannot be changed.

- Do NOT use this cycle with delicate items or fabrics.

## Sorting Loads

### Fabric care labels

Most articles of clothing feature fabric care labels that include instructions for proper care.

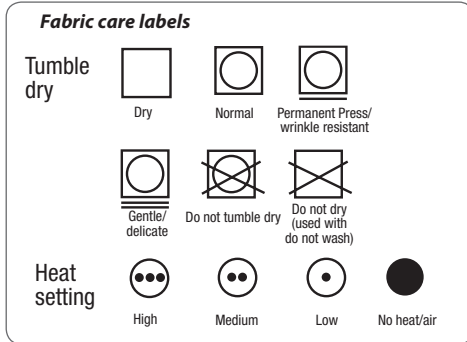

### Grouping Similar Items

For best results, sort clothes into loads that can be dried with the same drying cycle.

Different fabrics have different care requirements, and some fabrics will dry more quickly than others.

## Loading the Dryer

### ⚠ WARNING

To reduce the risk of fire, electric shock, or injury to persons when using this appliance, follow basic precautions, including the following:

- **Check all pockets to make sure that they are empty. Items such as clips, pens, coins, and keys can damage both your dryer and your clothes. Flammable objects such as lighters or matches could ignite, causing a fire.** Failure to do so can result in fire, explosion, or death.
- **Never dry clothes that have been exposed to oil, gasoline, or other flammable substances. Washing clothes will not completely remove oil residues.** Failure to obey this warning can result in fire, explosion, or death.

### ! NOTE

#### Loading tips

- Combine large and small items in a load.
- Damp clothes will expand as they dry. Do not overload the dryer; clothes require room to tumble dry properly.
- Close zippers, hooks, and drawstrings to prevent these items from snagging or tangling on other clothes.

## Check the Lint Filter before Every Load

Always make sure the lint filter is clean before starting a new load; a clogged lint filter will increase drying times.

To clean, pull the lint filter straight up and roll any lint off the filter with your fingers. Do not rinse or wash the filter to remove lint. Push the lint filter firmly back into place. See **Regular Cleaning** for more information.

Always ensure the lint filter is properly installed before running the dryer. Running the dryer with a loose or missing lint filter will damage the dryer and articles in the dryer.

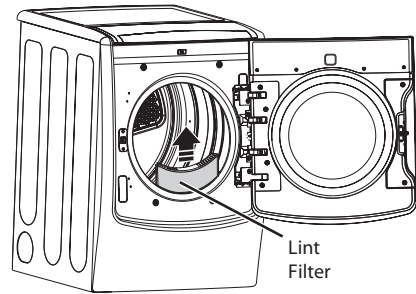

## Storage Under the Lid

- Under the lid are three small storage spaces.
- To open the lid, slide it back.

### ⚠ WARNING

Do not store flammable substances or adhesives under the lid.

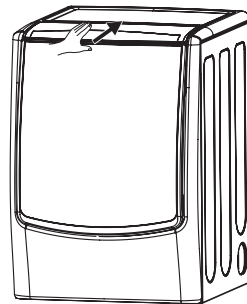



## Using the Lid

### Opening the lid

- Push the front handle to slide the lid open.

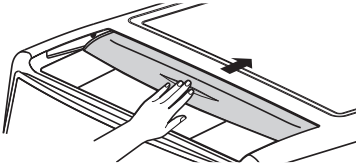

### Closing the lid

- Pull the top of the handle to slide the lid closed.

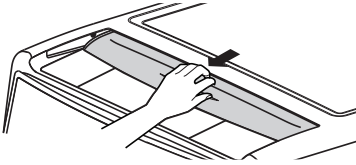

### WARNING

- To avoid injury, do not place fingers under the lid or between the lid and the cabinet when pressing or sliding the top lid open or closed.

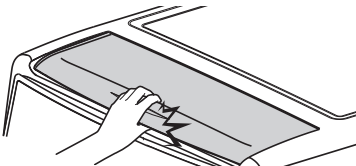
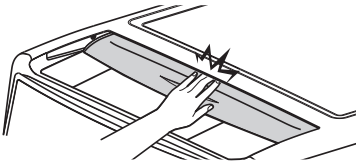

## Cycle Modifier Buttons

SENSOR DRY cycles have preset settings that are selected automatically. MANUAL DRY cycles have default settings, but you may also customize the settings using the cycle modifier buttons. Press the button for that option to view and select other settings.

### ! NOTE

To protect your garments, not every dryness level, temperature, or option is available with every cycle. See the Cycle Guide for details.

### DRY LEVEL

Selects the level of dryness for the cycle. Press the DRY LEVEL button repeatedly to scroll through available settings.

- This option is only available with SENSOR DRY cycles.
- The dryer will automatically adjust the cycle time. Selecting MORE or VERY increases the cycle time, while LESS or DAMP decreases the cycle time.
- Use a LESS or DAMP setting for items that you wish to iron.

### TEMP.

Adjusts the temperature setting from ULTRA LOW to HIGH. This allows precise care of your fabrics and garments. Press the TEMP. button repeatedly to scroll through available settings.

### TIME DRY

Allows you to manually select the drying time, from 20 to 60 minutes, in 10-minute increments. Use this for small loads or to remove wrinkles. Use the MORE TIME/ LESS TIME buttons to add or reduce the drying time in 1-minute increments.

Your dryer features several additional cycle options to customize cycles to meet your individual needs. Certain option buttons also feature a special function (see the following page for details) that can be activated by pressing and holding that option button for 3 seconds.

### To Add Cycle Options to a Cycle:

1. Turn on the dryer and press the cycle selector buttons repeatedly to select the desired cycle.
2. Use the cycle modifier buttons to adjust the settings for that cycle.
3. Press the cycle option button(s) for the option you would like to add. A confirmation message is shown in the display.
4. Press and hold the Start button to start the cycle. The dryer starts automatically.

### SIGNAL

Adjusts the volume or turns off the button sounds and end of cycle melody. Press the button repeatedly until the desired volume setting is illuminated.

## Special Functions

The option buttons also activate special functions, including CHILD LOCK. Select the option by pressing the option button. Press and hold the option button to select special features marked with the asterisk (\*), such as Child Lock.

### **\*CHILD LOCK**

Use this option to prevent unwanted use of the dryer or to keep cycle settings from being changed while the dryer is operating. Press and hold the button for 3 seconds to activate or deactivate the CHILD LOCK function.

The CHILD LOCK icon is shown in the display, and all controls are disabled except the POWER button.

### **! NOTE**

Once set, CHILD LOCK remains active until it is manually deactivated. CHILD LOCK must be turned off to run another cycle. To deactivate CHILD LOCK, press and hold the button for three seconds.

### **DAMP DRY SIGNAL**

With this option, the dryer signals when the load is approximately 80% dry. This allows you to remove faster-drying lightweight items or items that you would like to iron or hang while still slightly damp. Press the DAMP DRY SIGNAL button.

### **WRINKLE CARE**

Selecting this option will tumble the load periodically for up to 3 hours after the selected cycle, or until the door is opened. This is helpful in preventing wrinkles when you are unable to remove items from the dryer immediately.

### **ENERGY SAVER**

This option helps to reduce the energy consumption in the Normal cycle, depending on the load size. When the Energy Saver option is selected, the cycle begins with an air dry section and the drying time is increased.

### **SMART GRID**

Lower your energy costs when you dry your clothes by avoiding peak usage times. See the Smart Connectivity section for more information.

### **\*REMOTE START**

Use a smart phone to control the dryer remotely. See the Smart Connectivity section for more information.

## Custom Program

If you have a special combination of settings that you use frequently, you can save these settings as a CUSTOM PROGRAM.

### To Save a Custom Program:

1. Turn on the dryer and press the cycle selector buttons repeatedly to select the desired cycle.
2. Use the cycle modifier buttons to adjust the settings for that cycle.
3. Press the cycle option button(s) for the option you would like to add. A confirmation message will be shown in the display.
4. Press and hold the PGM Save button for 3 seconds.

### NOTE

You may save only one custom program at a time. Pressing and holding the PGM Save button will overwrite any previously saved custom program.

### Recalling a Custom Program

1. Turn on the dryer.
2. Press the CUSTOM PGM button.
3. Press and hold the Start button to start the cycle.

## Steam Functions

LG's new steam technology allows you to inject fabrics with a swirling jet of hot steam to refresh clothes. Simply select the STEAM FRESH™ cycle, or you can add a steam option to selected cycles.

### The STEAM FRESH™ Cycle

STEAM FRESH™ uses the power of steam to quickly reduce wrinkles and odor in fabrics. It brings new life to wrinkled clothes that have been stored for an extended time and makes heavily wrinkled clothes easier to iron. STEAM FRESH™ can also be used to help reduce odors in fabrics.

### NOTE

- The TurboSteam option is activated by default when the Steam Fresh™ or Steam Sanitary™ cycles are selected.
- Depending on the load (quantity of items), you may change the amount of time for the cycle by pressing the MORE TIME or LESS TIME button. The display will show 1, 3, 5, or  $\frac{b}{l} \frac{g}{g}$ . 3 means 3 or fewer items, 5 is for 4 or 5 items, and  $\frac{b}{l} \frac{g}{g}$  indicates a large load such as a comforter.

### Using the STEAM FRESH™ Cycle

1. Turn on the dryer and press the cycle selector buttons repeatedly to select the STEAM FRESH™ cycle.
2. To add an option function, select TurboSteam, or WRINKLE CARE.
3. Depending on the load (quantity of items), steam time can be changed by pressing the MORE TIME or LESS TIME buttons.
4. Press and hold Start to start the cycle.

### Adding STEAM to a Standard Cycle

1. Turn on the dryer and press the cycle selector buttons repeatedly to select the Normal, Perm. Press, or Heavy Duty cycle.
2. Use the cycle modifier buttons to adjust the settings for that cycle.
3. Press the TurboSteam button.
4. Press and hold Start to start the cycle.

### The STEAM SANITARY™ Cycle

The STEAM SANITARY™ cycle is ideal for sanitizing non-washable items quickly and easily using only steam. This cycle is recommended for use with cotton and polyester materials only. (Do NOT use for urethane foam, down feathers or delicate items)

## Steam Functions (cont.)

### ⚠ WARNING

- **Do not open the dryer door during steam cycles.** Failure to follow this warning can cause serious injury or death.
- **Do not touch the steam nozzle in the drum during or after the steam cycle.** Failure to follow this warning can cause serious injury or death.

### ! NOTE

- Steam may not be clearly visible during the steam cycles. This is normal.
- Do not use Steam Fresh™ with items such as wool clothing or blankets, leather jackets, silk, wet clothes, lingerie, foam products, or electric blankets.
- For best results, load articles of similar size and fabric type. Do not overload.
- When the filter/duct is clogged, the steam option may not have optimal results.
- When the steam function is operating, the drum will stop to allow steam to stay in the drum.

## Steam Cycle Guide

	Steam	Default Time	Temp.	Dry Level	Fabric State	Fabric Type	Maximum Amount
Steam Sanitary™		31 minutes			Dry	Comforter Bedding	Single (1 each)
			Children's clothing	3 lbs.			
Steam Fresh™		10 minutes	○		Dry	Comforter	Single (1 each)
						Shirts*	5 each
Steam Option	+ Turbo Steam	Follows Selected Cycle		○	Wet	Varies by selected cycle	8 lbs. (18 Items)

\*Shirt: 70% cotton/30% poly blend. Except especially delicate fabrics.

- When the lint filter or exhaust duct is clogged, steam options will not give proper results.
- For best results, load articles of similar size and fabric type. Do not overload.

# SMART APPLIANCE CONNECTIVITY

## Connectivity Overview

This smart appliance offers options for how you do laundry. Once it is connected to the internet through a home Wi-Fi network, you can check the progress of a cycle and control the appliance remotely with the LG Smart Laundry application for your smart phone.

The application can be set up to send push notifications when the cycle is complete or the appliance has problems. It also provides a list of extra cycles available for download, and helps to troubleshoot problems by recording and analyzing data from the appliance. The appliance has Smart Grid capability for areas where the utility company has installed Smart Grid equipment. This feature adjusts the appliance operating times based on when electricity prices are lower or delays operation when the demand for electricity is high.

## Connectivity Setup

### Install LG Smart Laundry application

1. Run the Google Play Store on an Android smart phone.
  2. Search for LG Smart Laundry.
  3. Press LG Smart Laundry on the resulting list.
  4. Press INSTALL and ACCEPT to automatically install the application. You can also check the progress through the smart phone.
  5. When the installation is complete, touch the icon to access the application.
- LG Smart Laundry application for iOS devices will be supported later.

### Profile Setup (ID and Password setup)

You can skip these steps if you already have an LG account at <http://us.smarthinQ.com>

1. Run the LG Smart Laundry application on a smart phone.
2. Select Login at the bottom of the screen.
3. Select *Create an account* at the bottom of the screen.
4. On the next page, agree to the Terms and Conditions, Privacy Policy, and LG Account Terms and Conditions. After selecting *I agree*, press Confirm.
5. Next, in the e-mail box, enter your email address. This will be your user ID. You will receive a confirmation email for activating the account at that email address.
6. Enter a password. Passwords are case sensitive. The password should be 6-12 characters. Remember your ID and password. They will be used on the LG Smart Laundry application to use Smart Appliance Connectivity functions.
7. Enter your name.
8. Enter your mobile number.
9. Press the Subscribe button. The system will send you an email containing a link to confirm your identity for the account.
10. Press the CONFIRM button in the confirmation email, and the website will display a confirmation page. Your account is now set up.

### Product Registration and Wi-Fi Setup

1. Run the LG Smart Laundry application on a smart phone.
2. Select Smart Appliance.
3. Select Dryer.
  - If you see a pop-up message about NFC, press the Cancel button.
4. Press the Wi-Fi model button at the bottom of the screen.
5. Enter the email ID and password you registered. If you don't have an account at <http://us.smarthinQ.com>, press the Create an Account button and create a user ID and password.
6. Select the Login button.
7. On the next page, the application shows the Wi-Fi network list. Select your home network. If your network requires a key, enter the password and select the Connect button.
8. If the application successfully connects to the home network, turn on the dryer and then press and hold the Wi-Fi Connect button on the dryer for three seconds. After powering on the dryer, do not press any other buttons before pressing and holding the Wi-Fi Connect button. The Wi-Fi connection indicator on the dryer blinks to indicate the machine is connecting.

9. The application now works to connect the appliance and register it as a Wi-Fi product. A notification appears when the dryer is successfully set up and the product registration and Wi-Fi setup is complete. The Wi-Fi connection indicator illuminates when the machine connects to the home network.

### NOTE

- The machine supports 2.4 GHz Wi-Fi networks only.
- Use the Settings menu in the application to register or change the machine. Select Settings > Change Product > Add Product and then follow steps 2–9 above.
- If the router or the router's password is changed, select Settings > Change Product > Add Product and then follow steps 2–9 above.
- If the appliance is having trouble connecting to the Wi-Fi network, it may be too far from the router. Purchase a Wi-Fi repeater (range extender) to improve the Wi-Fi signal strength.
- The Wi-Fi connection may not connect or may be interrupted because of the home network environment.
- The network connection may not work properly depending on the Internet service provider. The surrounding wireless environment can make the wireless network service run slowly.
- This information is current at the time of publication. The application is subject to change for product improvement purposes without notice to users.

## Smart ThinQ™

### Remote Start

Use a smart phone to control the appliance remotely. Or monitor the cycle operation to see the remaining time left in the cycle.

### NOTE

- You must first connect to a gateway and register your appliance in order to use the Remote Start function.
- The Remote LED on the control panel should be illuminated.

### Using Remote Start

1. Press and hold the Remote Start button. The Remote LED on the control panel is illuminated if the appliance is connected to a Wi-Fi network.
2. Start a cycle from the application on a smart phone. If the cycle is not started, the machine will wait to start the cycle until it is turned off remotely from the application or the Remote Start mode is disabled.

### NOTE

- Cycles and options cannot be selected at the appliance when the machine is in Remote Start mode.
- Press and hold the Remote Start button again to enable the Remote Start mode when the appliance is turned off or the Remote Start mode is released.

### Smart Grid

Reduce energy costs from drying clothes by avoiding peak usage periods, with information supplied by your local electric utility company.

If your utility company has equipped your home with Smart Grid technology, you will need to contact the utility company for information regarding the Smart Grid features.

### NOTE

- When Smart Grid is enabled, you may experience delays or extended cycle times during peak usage periods.

### NOTE

- You must first connect to a gateway and register your appliance in order to use the Smart Grid function.

### Download Cycle

The Download Cycle features of this appliance allow you to download new and special cycles that are not included in the basic cycles on the appliance.

Appliances that have been successfully registered can download a variety of specialty cycles specific to the appliance.

Only one cycle can be stored on the appliance at a time.

Once Cycle Download is completed in the dryer, the product keeps the downloaded cycle until you change it to a new download cycle.

#### ! NOTE

- You must first connect to a gateway and register your appliance in order to use the Download cycle function.

### Smart Diagnosis™

Use your phone to record the Smart Diagnosis™ signal if you have problems with your appliance.

The application can analyze the signal and help you solve the problem without waiting for a technician.

### Cycle Set

Cycle Set helps you choose the best cycle and settings based on your laundry needs.

Once you have selected your cycle based on the Cycle Set guide, the cycle and settings will be automatically set.

#### ! NOTE

- Cycle Set function can be enabled when the Remote Start button is activated.

### Laundry Stats

Laundry Stats will tell you basic stats about your appliance such as your cycle history and basic maintenance timing.

Select Laundry Stats in the application to get the stats and find out the dryer's vent status.

#### ! NOTE

- You must first connect to a gateway and register your appliance in order to use the Laundry Stats function.

### Smart Message

When the cycle is complete or the appliance has problems, you have the option of receiving push notifications on your smart phone.

#### ! NOTE

- You must first connect to a gateway and register your appliance in order to use the Smart Message function.

### Energy Monitoring

Your dryer energy usage is affected by the cycle and options so you may see some changes in energy usage from one cycle to another.

#### ! NOTE

- You must first connect to a gateway and register your appliance in order to use the Energy Monitoring function.



## USING Smart Diagnosis™

Should you experience any problems with your dryer, it has the capability of transmitting data to your Smart Phone using the LG Smart Laundry&DW Application or via your telephone to the LG call center.

Smart Diagnosis™ cannot be activated unless your dryer is turned on by pressing the Power button. If your dryer is unable to turn on, then troubleshooting must be done without using Smart Diagnosis™.

### Audible Diagnosis

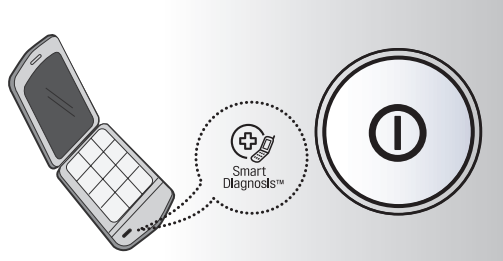

#### Smart Diagnosis™ Using Your Smart Phone

1. Download the LG Smart Laundry&DW application on your smart phone.
2. Open the LG Smart Laundry&DW application on your smart phone. Press the right arrow button to advance to the next screen.
3. Press the Record button on the smart phone and then hold the mouth piece of the smart phone near the Smart Diagnosis™ logo on the dryer.
4. With the phone held in place, press and hold Temp. button for three seconds.
5. Keep the phone in place until the tone transmission has finished. It takes time on panel displayed.
6. When the recording is complete, view the diagnosis by pressing the Next button on the phone.

#### ! NOTE

Smart Diagnosis™ is a troubleshooting feature designed to assist, not replace, the traditional method of troubleshooting through service calls. The effectiveness of this feature depends upon various factors, including, but not limited to, the reception of the cellular phone being used for transmission, any external noise that may be present during the transmission, and the acoustics of the room where the machine is located.

Accordingly, LG does not guarantee that Smart Diagnosis™ would accurately troubleshoot any given issue.

#### Smart Diagnosis™ Through the Call Center

1. Call the LG call center at: (LG U.S.) 1-800-984-6306 (LG Canada) 1-888-542-2623.
2. When instructed to do so by the call center agent, hold the mouthpiece of your phone over the Smart Diagnosis™ logo on the machine. Hold the phone no more than one inch (but not touching) the machine.

#### ! NOTE

Do not touch any other buttons or icons on the display screen.

3. Press and hold the Temp. button for three seconds.
4. Keep the phone in place until the tone transmission has finished. It takes time on panel displayed.
5. Once the countdown is over and the tones have stopped, resume your conversation with the call center agent, who will then be able to assist you in using the information transmitted for analysis.

# MAINTENANCE

## Regular Cleaning

### ⚠️ WARNING

To reduce the risk of fire, electric shock, or personal injury when using this appliance, follow basic precautions, including the following:

- **Unplug the dryer before cleaning to avoid the risk of electric shock.** Failure to follow this warning can cause serious injury, fire, electrical shock, or death.
- **Never use harsh chemicals, abrasive cleaners, or solvents to clean the washer.** They will damage the finish.

#### **Cleaning the Exterior**

Proper care of the dryer can extend its life. The outside of the machine can be cleaned with warm water and a mild, nonabrasive household detergent. Immediately wipe off any spills with a soft, damp cloth.

### ! NOTE

Do not use methylated spirits, solvents, or similar products.

Never use steel wool or abrasive cleansers; they can damage the surface.

#### **Cleaning the Interior**

Wipe around the door opening and seal with a soft, damp cloth to prevent lint and dust buildup that could damage the door seal.

Clean the window with a soft cloth dampened with warm water and a mild, nonabrasive household detergent; then wipe dry.

The stainless steel drum can be cleaned with a conventional stainless steel cleaner, used according to the manufacturer's specifications. Never use steel wool or abrasive cleansers; they can scratch or damage the surface.

#### **Cleaning Around and Under the Dryer**

Vacuum lint and dust from around the dryer and underneath it regularly. Vent ductwork should be checked for lint buildup and cleaned at least once per year. If any noticeable reduction in airflow or drying performance occurs, immediately check ductwork for obstructions and blockages.

#### **Maintaining Ductwork**

Vent ductwork should be checked for lint buildup and cleaned at least once per year. If any noticeable reduction in airflow or drying performance occurs, immediately check ductwork for obstructions and blockages. Contact a qualified technician or service provider.

### **Cleaning the Lint Filter**

Always clean the lint filter after every cycle.

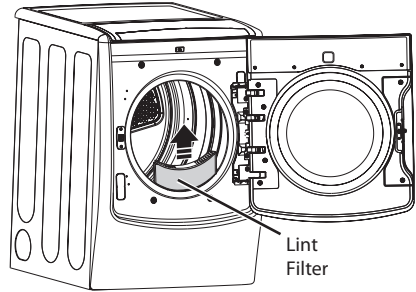

To clean, open the dryer door and pull the lint filter straight up. Then:

1. Roll any lint off the filter with fingers, or



2. Vacuum the lint filter, or

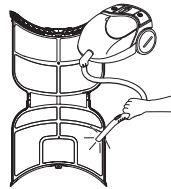

3. If the lint filter has become very dirty or clogged with fabric softener, wash the lint filter in warm, soapy water and allow to dry thoroughly before reinstalling.

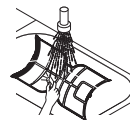

### ! NOTE

NEVER operate the dryer without the lint filter in place. NEVER operate the dryer with a wet lint filter.



## TROUBLESHOOTING

### Before Calling for Service

Your dryer is equipped with an automatic error-monitoring system to detect and diagnose problems at an early stage. If your dryer does not function properly or does not function at all, check the following before you call for service.

Problem	Possible Causes	Solutions
Dryer will not turn on	<ul style="list-style-type: none"> <li>• Power cord is not properly plugged in.</li> <li>• House fuse is blown, circuit breaker has tripped, or power outage has occurred.</li> </ul>	<ul style="list-style-type: none"> <li>• Make sure that the plug is plugged securely into a grounded outlet matching the dryer's rating plate.</li> <li>• Reset circuit breaker or replace fuse. Do not increase fuse capacity. If the problem is a circuit overload, have it corrected by a qualified electrician.</li> </ul>
Dryer does not heat	<ul style="list-style-type: none"> <li>• House fuse is blown, circuit breaker has tripped, or power outage has occurred.</li> <li>• Gas supply or service turned off (gas models only).</li> <li>• Energy Saver option selected</li> </ul>	<ul style="list-style-type: none"> <li>• Reset circuit breaker or replace fuse. Do not increase fuse capacity. If the problem is a circuit overload, have it corrected by a qualified electrician.</li> <li>• Confirm that the house gas shutoff and the dryer gas shutoff are both fully open.</li> <li>• If using the Cotton/Normal cycle, deselect the Energy Saver option. The Energy Saver option is selected by default. This option reduces energy use by adding an air dry section to the beginning of the cycle. It is normal to feel no heat at the beginning of the cycle while in Energy Saver mode.</li> </ul>
Greasy or dirty spots on clothes	<ul style="list-style-type: none"> <li>• Fabric softener used incorrectly.</li> <li>• Clean and dirty clothes being dried together.</li> </ul>	<ul style="list-style-type: none"> <li>• Confirm and follow the instructions provided with your fabric softener.</li> <li>• Make sure to use your dryer to dry only clean items, because dirty items can soil clean clothes placed in the same or subsequent loads.</li> <li>• Stains on dried clothes are actually stains that were not removed during the washing process. Make sure that clothes are being completely cleaned according to the instructions for your washer and detergent.</li> </ul>
Display shows error code tE1 or tE2	<ul style="list-style-type: none"> <li>• Thermistor is malfunctioning.</li> </ul>	<ul style="list-style-type: none"> <li>• Turn off the dryer and call for service.</li> </ul>
Lint on clothes	<ul style="list-style-type: none"> <li>• Lint filter not cleaned properly.</li> <li>• Laundry not sorted properly.</li> <li>• Excess static in clothes.</li> <li>• Dryer is overloaded.</li> <li>• Tissue, paper, etc., left in pockets.</li> </ul>	<ul style="list-style-type: none"> <li>• Make sure the lint filter is cleaned before every load. With some loads that produce high amounts of lint, it may be necessary to clean the filter during the cycle.</li> <li>• Some fabrics are lint producers (i.e., a fuzzy white cotton towel) and should be dried separately from clothes that are lint trappers (i.e., a pair of black linen pants).</li> <li>• See the Excess static in clothes after drying section below.</li> <li>• Divide larger loads into smaller loads for drying.</li> <li>• Check pockets thoroughly before washing and drying clothes.</li> </ul>
Excess static in clothes after drying	<ul style="list-style-type: none"> <li>• Fabric softener not used or used incorrectly.</li> <li>• Clothes dried too long (overdried).</li> <li>• Drying synthetics, permanent press, or synthetic blends.</li> </ul>	<ul style="list-style-type: none"> <li>• Use a fabric softener to reduce static electricity correctly. Do not use fabric softeners or products to eliminate static unless recommended by the manufacturer of the fabric softener or product.</li> <li>• Overdrying a load of laundry can cause a buildup of static electricity. Adjust settings and use a shorter drying time, or use SENSOR DRY cycles.</li> <li>• These materials can cause static buildup. Try using a fabric softener.</li> </ul>
Display shows error code PS	<ul style="list-style-type: none"> <li>• Power cord connection is incorrect.</li> </ul>	<ul style="list-style-type: none"> <li>• Check the connection of power cord to the terminal block. Refer to pages 26-29 in this manual.</li> </ul>

## Before Calling for Service (cont.)

Problem	Possible Causes	Solutions
Drying time is not consistent	<ul style="list-style-type: none"> <li>Heat settings, load size, or dampness of clothing is not consistent.</li> </ul>	<ul style="list-style-type: none"> <li>The drying time for a load will vary depending on the heat setting, the type of heat used (electric, natural gas, or LP gas), the size of the load, the type of fabrics, the wetness of the clothes, and the condition of the exhaust ducts and lint filter.</li> </ul>
Clothes take too long to dry	<ul style="list-style-type: none"> <li>Load is not properly sorted.</li> <li>Large load of heavy fabrics.</li> <li>Dryer controls are not set properly.</li> <li>Lint filter needs to be cleaned.</li> <li>Exhaust ducts blocked, dirty, or duct run is too long.</li> <li>House fuse is blown, circuit breaker has tripped, or power outage has occurred.</li> <li>Dryer is overloaded.</li> <li>Dryer is underloaded.</li> <li>Energy Saver option selected</li> </ul>	<ul style="list-style-type: none"> <li>Separate heavy items from lightweight items. Larger and heavier items take longer to dry.</li> <li>Heavy fabrics take longer to dry because they tend to retain more moisture. To help reduce and maintain more consistent drying times for large and heavy fabrics, separate these items into smaller loads of a consistent size.</li> <li>Use the appropriate control settings for the type of load you are drying.</li> <li>Make sure the lint filter is cleaned before every load. With some loads that produce high amounts of lint, it may be necessary to clean the filter during the cycle.</li> <li>Confirm that the exhaust ductwork is properly configured and free of debris, lint, and obstructions. Make sure that outside wall dampers can open properly and are not blocked, jammed, or damaged.</li> <li>Reset circuit breaker or replace fuse. Do not increase fuse capacity. If the problem is a circuit overload, have it corrected by a qualified electrician.</li> <li>Divide larger loads into smaller loads for drying.</li> <li>If you are drying a very small load, add a few extra items to ensure proper tumbling action.</li> <li>If using the Cotton/Normal cycle, deselect the Energy Saver option. This option reduces energy use by adding an air dry section to the beginning of the cycle.</li> </ul>
Clothes are wrinkled	<ul style="list-style-type: none"> <li>Clothes dried too long (overdried).</li> <li>Clothes left in dryer too long after cycle ends.</li> </ul>	<ul style="list-style-type: none"> <li>Overdrying a load of laundry can lead to wrinkled clothes. Try a shorter drying time, and remove items while they still retain a slight amount of moisture.</li> <li>Remove items from the dryer immediately at the end of the cycle. Use the WRINKLE CARE option to continue tumbling clothes at the end of the cycle, for up to 3 hours.</li> </ul>
Clothes are shrinking	<ul style="list-style-type: none"> <li>Garment care instructions are not being followed.</li> </ul>	<ul style="list-style-type: none"> <li>To avoid shrinkage, please carefully follow the fabric care instructions for your garment, because some fabrics will naturally shrink when washed. Other fabrics can be washed but will shrink when dried in a dryer. Use a low or no heat setting.</li> </ul>
Add indicator light is on during the drying cycle	<ul style="list-style-type: none"> <li>Water supply error.</li> </ul>	<ul style="list-style-type: none"> <li>Check steam feeder drawer:               <ol style="list-style-type: none"> <li>Make sure steam feeder is filled with water to MAX line.</li> <li>Make sure steam feeder is seated properly and drawer is fully closed.</li> <li>Turn the dryer off then restart the Steam cycle.</li> </ol> </li> <li>Do not use distilled water; the water level sensor in the steam generator will not work.</li> <li>The pump is not working. Unplug the dryer and call for service.</li> </ul>
Water drips from nozzle when Steam Cycle starts	<ul style="list-style-type: none"> <li>This is normal.</li> </ul>	<ul style="list-style-type: none"> <li>This is steam condensation. The dripping water will stop after a short time.</li> </ul>
The display shows "d80", "d90", "d95"  	<ul style="list-style-type: none"> <li>The duct work is about 80%, 90%-95% blocked. ("d80", "d90" or "d95" error code displayed 2 hours only)</li> <li>House exhaust system blocked.</li> </ul>	<ul style="list-style-type: none"> <li><b>Do not use the dryer until the exhaust system has been cleaned and/or repaired.</b> Using the dryer with a severely restricted exhaust is dangerous and could result in a fire or other property damage.</li> <li>Check the outside dryer vent while the dryer is operating to make sure there is strong airflow.</li> <li>If the exhaust system is extremely long, have it repaired or rerouted.</li> <li>Keep the area around the dryer clean and free of clutter.</li> <li>Check the vent hood for damage or lint clogging.</li> <li>Make sure the area around the vent hood is clear.</li> </ul>

## Before Calling for Service (cont.)

Problem	Possible Causes	Solutions
Steam does not generate but no error code is shown	<ul style="list-style-type: none"> <li>• Water level error.</li> </ul>	<ul style="list-style-type: none"> <li>• Unplug dryer and call for service.</li> </ul>
Garments still wrinkled after STEAM FRESH™	<ul style="list-style-type: none"> <li>• Too many or too different types of garments in dryer.</li> </ul>	<ul style="list-style-type: none"> <li>• Small loads of 1 to 5 items work best.</li> <li>• Load fewer garments. Load similar-type garments.</li> </ul>
There are no creases left on garment after STEAM FRESH™	<ul style="list-style-type: none"> <li>• The function of this cycle is to remove wrinkles from fabric.</li> </ul>	<ul style="list-style-type: none"> <li>• Use an iron to make creases.</li> </ul>
Water drips from door during Steam Cycle	<ul style="list-style-type: none"> <li>• This is normal.</li> </ul>	<ul style="list-style-type: none"> <li>• Condensation will normally form on the inside of the dryer door during steam operation. Some condensation may drip out the bottom of the door.</li> </ul>
Steam is not visible during Steam Cycle	<ul style="list-style-type: none"> <li>• This is normal.</li> </ul>	<ul style="list-style-type: none"> <li>• Steam vapor is difficult to see when the door is closed. However, condensation will normally form on the inside of the dryer door if the steam system is operating normally.</li> </ul>
Drum does not turn during Steam Cycle	<ul style="list-style-type: none"> <li>• This is normal.</li> </ul>	<ul style="list-style-type: none"> <li>• The drum is turned off so that the steam vapor remains in the drum. The drum will normally turn for about 2 seconds once a minute.</li> </ul>
Cannot see steam vapor at the beginning of cycle	<ul style="list-style-type: none"> <li>• This is normal.</li> </ul>	<ul style="list-style-type: none"> <li>• Steam is released at different stages of the cycle for each option.</li> </ul>
The display shows $b_i \ g$	<ul style="list-style-type: none"> <li>• MORE TIME button pressed.</li> </ul>	<ul style="list-style-type: none"> <li>• This display indicates that the steam option has been set for a "<math>b_i \ g</math>" item such as a comforter. Press the LESS TIME button to reduce the indicated load size.</li> </ul>
Odors remain in clothing after STEAM FRESH™	<ul style="list-style-type: none"> <li>• STEAM FRESH™ did not remove odor completely.</li> </ul>	<ul style="list-style-type: none"> <li>• Fabrics containing strong odors should be washed in a normal cycle.</li> </ul>
CHECK FILTER light is on during the drying cycle	<ul style="list-style-type: none"> <li>• Lint filter is almost clogged or full.</li> </ul>	<ul style="list-style-type: none"> <li>• Pause the drying cycle and clean the lint filter.</li> </ul>
FLOW SENSE™ indicator shows four bars during the drying cycle or the display shows "d80" after drying.	<ul style="list-style-type: none"> <li>• Ductwork is too long or has too many turns/restrictions.</li> <li>• Significant blockage of the ductwork due to lint buildup or debris.</li> <li>• The appliance has detected a restriction in the external dryer venting.</li> </ul>	<ul style="list-style-type: none"> <li>• Install a shorter or straighter duct run. See the Installation Instructions.</li> <li>• Ductwork should be checked/cleaned soon. Dryer can be used in this condition, but drying times may be longer.</li> <li>• If exhaust restrictions are sensed by the Flow Sense™ system, the indicator will remain on for two hours after the end of the cycle. Opening the door or pressing the Power button will turn off the display.</li> </ul>

# SPECIFICATIONS

Steam Dryer Models	DLEX9500* DLGX9501*
Description	Steam Dryer
Electrical Requirements	Please refer to the rating label regarding detailed information.
Gas Requirements	NG: 4-10.5 inches WC LP: 8-13 inches WC
Dimensions	29"(W) X 33 3/8"(D) X 40 7/8"(H), 56" (D with door open) 74.0 cm (W) X 84.8 cm (D) X 103.9 cm (H), 143.0 cm (D with door open)
Net Weight	Gas dryer : 160.7 lbs(72.9 kg) Electric dryer : 157.4 lbs(71.4 kg)
Drying Capacity - Normal Cycle - Steam Cycle	IEC 9.0 cu.ft. (27.3 lbs/12.4 kg) IEC 9.0 cu.ft. (8 lbs/3.6 kg)

# WARRANTY (USA)

Should your LG Dryer ("Product") fail due to a defect in materials or workmanship under normal home use, during the warranty period set forth below, LG will at its option repair or replace the product. This limited warranty is valid only to the original retail purchaser of the product and applies only when purchased and used within the United States including U.S. Territories. Proof of original retail purchase is required to obtain warranty service under this limited warranty.

Warranty Period	Scope of Warranty	HOW SERVICE IS HANDLED
One (1) year from date of original retail purchase	Parts and Labor	LG will provide parts and labor to repair or replace defective parts.
Ten (10) years from date of original retail purchase	Dryer drum	Parts only. Customer will be responsible for any labor or in-home service to replace defective parts.

- Replacement products and parts are warranted for the remaining portion of the original warranty period or ninety (90) days, whichever is greater.
- Replacement products and parts may be new or remanufactured.

**THIS WARRANTY IS IN LIEU OF ANY OTHER WARRANTY, EXPRESS OR IMPLIED, INCLUDING WITHOUT LIMITATION, ANY WARRANTY OF MERCHANTABILITY OR FITNESS FOR A PARTICULAR PURPOSE. TO THE EXTENT ANY IMPLIED WARRANTY IS REQUIRED BY LAW, IT IS LIMITED IN DURATION TO THE EXPRESS WARRANTY PERIOD ABOVE. NEITHER THE MANUFACTURER NOR ITS U.S. DISTRIBUTOR SHALL BE LIABLE FOR ANY INCIDENTAL, CONSEQUENTIAL, INDIRECT, SPECIAL, OR PUNITIVE DAMAGES OF ANY NATURE, INCLUDING WITHOUT LIMITATION, LOST REVENUES OR PROFITS, OR ANY OTHER DAMAGE WHETHER BASED IN CONTRACT, TORT, OR OTHERWISE.**

Some states do not allow the exclusion or limitation of incidental or consequential damages or limitations on how long an implied warranty lasts, so the above exclusion or limitation may not apply to you. This warranty gives you specific legal rights and you may also have other rights that vary from state to state.

## **THIS LIMITED WARRANTY DOES NOT COVER:**

- Service trips to deliver, pick up, or install or repair the product; instruction to the customer on operation of the product; repair or replacement of fuses or correction of wiring or plumbing, or correction of unauthorized repairs/ installation.
- Failure of the product to perform during power failures and interruptions or inadequate electrical service.
- Damage caused by leaky or broken water pipes, frozen water pipes, restricted drain lines, inadequate or interrupted water supply or inadequate supply of air.
- Damage resulting from operating the Product in a corrosive atmosphere or contrary to the instructions outlined in the Product's owner's manual.
- Damage to the Product caused by accidents, pests and vermin, lightning, wind, fire, floods, or acts of God.
- Damage or failure caused by unauthorized modification or alteration, or if it is used for other than the intended purpose, or any water leakage where the unit was not properly installed.
- Damage or failure caused by incorrect electrical current, voltage, or plumbing codes, commercial or industrial use, or use of accessories, components, or consumable cleaning products that are not approved by LG.
- Damage caused by transportation and handling, including scratches, dents, chips, and/or other damage to the finish of your product, unless such damage results from defects in materials or workmanship and is reported within one (1) week of delivery.
- Damage or missing items to any display, open box, discounted, or refurbished Product.
- Products with original serial numbers that have been removed, altered, or cannot be readily determined. Model and Serial numbers, along with original retail sales receipt, are required for warranty validation.
- Increases in utility costs and additional utility expenses.

- Repairs when your Product is used in other than normal and usual household use (e.g. commercial use, in offices and recreational facilities) or contrary to the instructions outlined in the Product's owner's manual.
- Costs associated with removal of your Product from your home for repairs.
- The removal and reinstallation of the Product if it is installed in an inaccessible location or is not installed in accordance with published installation instructions, including LG's owner's and installation manuals.
- Damage resulting from misuse, abuse, improper installation, repair, or maintenance. Improper repair includes use of parts not approved or specified by LG.

**Filter is clogged.**

- Not heating, long dry time

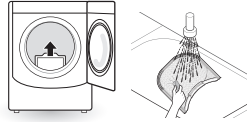

- Clean the lint filter.

**Duct is clogged.**

- Not heating, long dry time

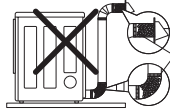

- Clean the hood and duct.

**Excessive duct length and/or multiple elbows**

- Not heating, long dry time

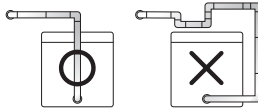

- Keep exhaust ducts as short as possible, using as few elbows and bends as possible.

**Improperly connected power cord or electrical outlet issue.**

- No Power
- Not Heating

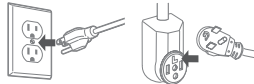

- Reconnect power cord, replace house fuse or reset breaker. If outlet is issue, electrician may be required.

**Gas valve is not turned on. (Gas Dryer)**

- Not heating

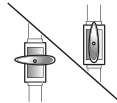

- Open the gas valve

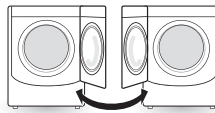
**Door Reversal**

- Instructions for door reversal can be found in the owner's manual.

**The cost of repair or replacement under these excluded circumstances shall be borne by the consumer.**

**OBTAIN WARRANTY SERVICE AND ADDITIONAL INFORMATION**

If you do not have access to the internet and you need assistance using your product or you would like to schedule service, you may contact LG Electronics at the number below.

For assistance or service, call 1-800-984-6306.

If you need further assistance, you can write to LG with any questions or concerns at the address below:

LG Electronics, 201 James Record Road, Huntsville, Alabama 35813

For additional product information, visit our website at <http://www.lg.com>





# LG SIGNATURE

## MANUAL DEL USUARIO SECADORA

Lea atentamente este manual antes de utilizar su secadora y manténgalo a mano en todo momento para futuras consultas.

DLEX9500\*

DLGX9501\*

## TABLA DE CONTENIDOS

### 3 INSTRUCCIONES IMPORTANTES DE SEGURIDAD

---

- 3 QUÉ HACER SI HUELE GAS
- 4 PRECAUCIONES BÁSICAS DE SEGURIDAD
- 4 LEY EJECUTIVA PARA LA SEGURIDAD DEL AGUA POTABLE Y LOS TÓXICOS DE CALIFORNIA (CALIFORNIA SAFE DRINKING WATER AND TOXIC ENFORCEMENT ACT)
- 5 INSTRUCCIONES DE CONEXIÓN A TIERRA
- 5 INSTRUCCIONES IMPORTANTES PARA LA INSTALACIÓN
- 6 INSTRUCCIONES DE SEGURIDAD PARA FUNCIONES DE VAPOR
- 7 INSTRUCCIONES IMPORTANTES PARA CONECTAR LA ELECTRICIDAD

### 8 INFORMACIÓN SOBRE TRANSMISOR MÓDULO

---

### 9 CARACTERÍSTICAS ESPECIALES

---

### 10 DESCRIPCIÓN DEL PRODUCTO

---

- 10 Partes
- 10 Accesorios
- 11 Características del panel de control
- 12 Pantalla

### 13 INSTALACIÓN

---

- 13 Descripción de la instalación
- 14 Requisitos Del Lugar De Instalación
- 14 Espacios de instalación
- 15 Separaciones con base pedestal opcional
- 16 Nivelación de la secadora
- 17 Inversión de la puerta
- 19 Instalación del kit de ventilación lateral
- 20 Conexión del conducto de ventilación de la secadora
- 22 Manguera de entrada
- 23 Conexión de secadoras a gas
- 25 Cómo conectar las secadoras eléctricas
- 30 Requisitos especiales para viviendas móviles o prefabricadas
- 30 Revisión de instalación final

- 31 Prueba de instalación  
(Comprobación del sistema de evacuación)

### 33 CÓMO USAR

---

- 33 Funcionamiento de la secadora
- 34 Guía de ciclos
- 35 Clasificación de cargas
- 35 Cómo cargar la secadora
- 35 Revise el filtro de pelusa antes de cada uso
- 35 Almacenamiento bajo la Tapa
- 36 Uso de la Tapa
- 37 Botones modificadores de ciclo
- 38 Funciones especiales
- 39 Programa personalizado
- 40 Funciones de vapor
- 40 Guía de ciclo de vapor

### 41 CONECTIVIDAD CON DISPOSITIVOS INTELIGENTES

---

- 41 Información general de conectividad
- 41 Configuración de la conectividad
- 42 Smart ThinQ™

### 44 UTILIZACIÓN DEL SMARTDIAGNOSIS™

---

### 45 MANTENIMIENTO

---

- 45 Limpieza regular

### 46 RESOLUCIÓN DE PROBLEMAS

---

- 46 Antes de llamar a mantenimiento

### 49 ESPECIFICACIONES

---

### 50 GARANTÍA

---

# INSTRUCCIONES IMPORTANTES DE SEGURIDAD

## LEA TODAS LA INSTRUCCIONES ANTES DE USAR

### ⚠️ ADVERTENCIA

Por su seguridad, debe seguir la información indicada en este manual para minimizar el riesgo de incendio o explosión, descarga eléctrica, o para prevenir daños a la propiedad, lesiones personales o muerte.

#### Su Seguridad y la de los demás son de suma importancia.

En este manual y en su electrodoméstico figuran muchos mensajes importantes de seguridad. Lea y cumpla siempre con todos los mensajes de seguridad.

⚠️ Éste es el símbolo de alerta de seguridad.

El mismo alerta sobre potenciales riesgos de muerte o heridas tanto para usted como para otras personas. Todos los mensajes de seguridad estarán a continuación del símbolo de alerta de seguridad y con la palabra PELIGRO, ADVERTENCIA o PRECAUCIÓN.

Estas palabras significan:

#### ⚠️ PELIGRO

Corre riesgo de muerte o de sufrir heridas serias si no sigue las instrucciones inmediatamente.

#### ⚠️ ADVERTENCIA

Corre riesgo de muerte o de sufrir heridas serias si no sigue las instrucciones.

#### ⚠️ PRECAUCIÓN

De no seguir las instrucciones podría sufrir daños leves o causar daños en el producto.

Todos los mensajes de seguridad le indicarán cuál es el riesgo potencial, le dirán cómo reducir las posibilidades de sufrir heridas y qué puede suceder si no se siguen las instrucciones.

- **No instale una secadora junto a materiales de ventilación plásticos flexibles. Si se instala un conducto flexible metálico (de tipo lámina de metal), éste deberá cumplir las especificaciones determinadas por el fabricante del electrodoméstico para su uso con secadoras. Se sabe que los materiales de ventilación flexibles se contraen, se agrietan con rapidez y atrapan pelusas. Estas condiciones obstruirán el flujo de aire de la secadora y aumentarán el riesgo de incendio.**
- **Instale la secadora según las instrucciones del fabricante y las normativas locales.**
- **Guarde estas instrucciones.**

### ⚠️ ADVERTENCIA

#### RIESGO DE INCENDIO O EXPLOSIÓN

Si no se observan estrictamente las advertencias de seguridad, pueden producirse daños materiales, lesiones graves o la muerte.

- No almacene ni use gasolina u otros líquidos o vapores inflamables cerca de este artefacto ni de ningún otro.

- **QUÉ HACER SI HUELE GAS**

- No intente encender ningún aparato.
- No toque ningún interruptor eléctrico ni use ningún teléfono de su edificio.
- Evacue a todos los ocupantes de la habitación, el edificio o el área.
- Llame a su compañía de gas inmediatamente desde el teléfono de un vecino. Siga las instrucciones de la compañía de gas.
- Si no puede comunicarse con su compañía de gas, llame al departamento de bomberos.

- La instalación y el mantenimiento deben ser realizados por un instalador, una agencia de servicio o una compañía de gas calificados.

# INSTRUCCIONES IMPORTANTES DE SEGURIDAD

## LEA TODAS LA INSTRUCCIONES ANTES DE USAR

### ADVERTENCIA

Por su seguridad, debe seguir la información indicada en este manual para minimizar el riesgo de incendio o explosión, descarga eléctrica, o para prevenir daños a la propiedad, lesiones personales o muerte.

## PRECAUCIONES BÁSICAS DE SEGURIDAD

### ADVERTENCIA

Para minimizar el riesgo de incendio o explosión, descarga eléctrica, o para prevenir lesiones personales cuando use electrodomésticos, se deben seguir precauciones básicas de seguridad, incluyendo las siguientes:

- Lea todas las instrucciones antes de usar la secadora.
- Antes de usar, la secadora debe estar correctamente instalada como se describe en este manual.
- **No coloque artículos que hayan sido expuestos a aceites, incluyendo aceites comestibles, en su secadora. Los artículos contaminados con aceites comestibles podrían contribuir a la generación de una reacción química que podría ocasionar que una carga se incendie.**
- No seque artículos que hayan sido limpiados, lavados, remojados o salpicados previamente con gasolina, disolventes de limpieza en seco u otras sustancias inflamables o explosivas, ya que emanan vapores que podrían encenderse o explotar, incluso después del lavado.
- **No introduzca las manos en la secadora cuando el tambor o las otras partes estén en movimiento.**
- No repare o reemplace ninguna parte de la secadora ni intente reparar la misma a menos que esto se recomiende en forma específica en esta Guía de Uso y Cuidado o en instrucciones de reparación publicadas las cuales comprende y sabe aplicar.
- **No altere los controles.**
- Antes de poner la secadora fuera de servicio o de tirarla, quite la puerta para prevenir que los niños se metan dentro.
- No deje que los niños jueguen en la secadora ni dentro de ella. Cuando se usa la secadora cerca de los niños, se necesita una supervisión estricta.
- Use suavizadores de tela o productos para eliminar estática únicamente del modo recomendado por el fabricante.
- **No use calor para secar artículos que contienen caucho espumoso, plásticos o materiales de textura similar al caucho.**
- Evite la acumulación de pelusa, polvo o tierra alrededor del área de la apertura de ventilación y áreas adyacentes.
- La parte interior de la secadora y el conducto de ventilación se deberán limpiar periódicamente, y la misma deberá ser realizada por personal calificado del servicio.
- No instale ni coloque esta secadora en lugares donde pueda estar expuesta a variables climáticas.
- Antes de cargar la secadora, siempre revise que no haya objetos extraños en su interior.
- Retire la pelusa del filtro antes de cada carga.
- **No deje plásticos, papel o telas que puedan quemarse o fundirse sobre la secadora en funcionamiento.**

## LEY EJECUTIVA PARA LA SEGURIDAD DEL AGUA POTABLE Y LOS TÓXICOS DE CALIFORNIA (CALIFORNIA SAFE DRINKING WATER AND TOXIC ENFORCEMENT ACT)

Esta ley requiere que el gobernador de California publique un listado de sustancias conocidas en el estado que causan cáncer, defectos congénitos u otras lesiones reproductivas, y obliga a los negocios a alertar a los clientes sobre la posible exposición a tales sustancias. Los electrodomésticos a gas pueden causar exposición leve a cuatro de estas sustancias, principalmente benceno, monóxido de carbono, formaldehído y hollín, generado principalmente por la combustión parcial del gas natural o los combustibles LP (petróleo líquido). Las secadoras calibradas adecuadamente minimizarán la combustión parcial. Para minimizar incluso más la exposición a estas sustancias, se puede dotar a la secadora de la ventilación adecuada al exterior.

 **ADVERTENCIA:** Este producto contiene químicos conocidos por el Estado de California como causantes de cáncer y defectos de nacimiento u otros daños reproductivos. *Lávese las manos después de usarlo.*

# INSTRUCCIONES IMPORTANTES DE SEGURIDAD

## LEA TODAS LA INSTRUCCIONES ANTES DE USAR

### ADVERTENCIA

Por su seguridad, debe seguir la información indicada en este manual para minimizar el riesgo de incendio o explosión, descarga eléctrica, o para prevenir daños a la propiedad, lesiones personales o muerte.

### INSTRUCCIONES DE CONEXIÓN A TIERRA

Este electrodoméstico deberá estar conectado a tierra. En caso de avería o mal funcionamiento, la conexión a tierra reducirá el riesgo de descargas eléctricas al brindar un camino con una resistencia menor para la corriente eléctrica. Este electrodoméstico debe estar equipado con un cable con un conductor para la conexión a tierra del equipo y un enchufe con conexión a tierra. El enchufe deberá estar conectado a una toma de corriente instalada en forma adecuada y con conexión a tierra de acuerdo con todos los códigos y ordenanzas locales.

### INSTRUCCIONES IMPORTANTES PARA LA INSTALACIÓN

### ADVERTENCIA

Para reducir el riesgo de incendio, descargas eléctricas o heridas al usar su electrodoméstico, siga las precauciones básicas, incluyendo lo siguiente:

- **Conecte la secadora adecuadamente a tierra según todos los códigos y las regulaciones vigentes.** Siga los detalles en las instrucciones de instalación. Si la secadora no se encuentra adecuadamente conectada a tierra se pueden producir descargas eléctricas.
- **Antes de usar, la secadora debe estar correctamente instalada como se describe en este manual.** Si la secadora no se encuentra adecuadamente conectada a tierra se pueden producir descargas eléctricas.
- **Instale y almacene la secadora en un lugar no expuesto a temperaturas inferiores al punto de congelación ni expuesto a la intemperie.**
- **Todas las reparaciones y controles deberán ser realizados por un centro de servicio autorizado a menos que se den otras recomendaciones específicas en el Manual del Usuario. Utilice sólo piezas de fábrica autorizadas.** Si no se cumple con esta advertencia se podrán producir heridas graves, incendios, descargas eléctricas o muerte.
- **Con el fin de reducir el riesgo de descargas eléctricas no instale la secadora en espacios húmedos.** Si no se cumple con esta advertencia se podrán producir heridas graves, incendios, descargas eléctricas o muerte.
- **Conecte un circuito eléctrico clasificado, protegido y adecuado para evitar sobrecarga eléctrica.** Un circuito eléctrico inadecuado se puede fundir, creando descargas eléctricas y/o riesgo de incendio.
- **Mantenga todos los envoltorios alejados de los niños.** Los materiales de los envoltorios pueden resultar peligrosos para los niños. Existe riesgo de asfixia.
- **Quite todos los elementos de embalaje y deseche adecuadamente todos los materiales de envío.** Si no se cumple con esto se podrá producir una explosión, incendio, quemaduras o muerte.
- **Coloque la secadora a un altura mínima de 18 pulgadas encima del piso para una instalación en el garaje.** Si no se cumple con esto se podrá producir una explosión, incendio, quemaduras o muerte.
- **No lo instale cerca de un elemento que genera calor, Como una estufa, horno o calentador.** Si no lo hace puede ocasionar daños en el equipo, humos o un incendio.
- **No coloque velas o cigarrillos sobre el producto.** Si no lo hace puede ocasionar daños en el equipo, humos o un incendio.
- **Quite la película de vinilo protectora del producto.** Si no lo hace puede ocasionar daños en el equipo, humos o un incendio.

# INSTRUCCIONES IMPORTANTES DE SEGURIDAD

## LEA TODAS LA INSTRUCCIONES ANTES DE USAR

### ⚠️ ADVERTENCIA

Por su seguridad, debe seguir la información indicada en este manual para minimizar el riesgo de incendio o explosión, descarga eléctrica, o para prevenir daños a la propiedad, lesiones personales o muerte.

## INSTRUCCIONES IMPORTANTES PARA LA INSTALACIÓN

### ⚠️ ADVERTENCIA

Para reducir el riesgo de lesiones personales, cumpla con todos los procedimientos de seguridad recomendados por la industria, incluyendo el uso de guantes con mangas largas y gafas de seguridad. En caso de no cumplir con todas las advertencias de seguridad de este manual se podrán producir daños sobre la propiedad, lesiones personales o la muerte.

Conducto de escape/Tubería:

- **Las secadoras a gas DEBEN tener un conducto de ventilación al exterior.** Si no se siguen estas instrucciones se podrá producir incendio o muerte.
- **Para prevenir el ingreso de grandes cantidades de humedad y pelusa a la habitación, se recomienda enfáticamente dotar las secadoras eléctricas de un conducto de ventilación al exterior.** La acumulación de pelusa en cualquier parte de la casa puede crear riesgos de salud e incendio.
- **Use únicamente sistemas de ventilación de metal rígido o flexible de 4 pulgadas de diámetro dentro del gabinete de la secadora o para ventilación al exterior. Los sistemas de ventilación de plástico u otro material pueden causar incendios.** Los sistemas de ventilación agujereados pueden causar incendios si se colapsan o bloquean durante el uso o la instalación.
- **No se provee el sistema de ventilación con la secadora; el mismo deberá obtenerse localmente. La tapa terminal deberá tener reguladores de tiro con bisagras para prevenir el retorno de descarga cuando no se usa la secadora.** Si no se siguen estas instrucciones se podrá producir incendio o muerte.
- **El conducto de escape deberá tener 10,2 cm (4 pulg.) de diámetro sin obstrucciones. El conducto de escape deberá mantenerse lo más corto posible. Asegúrese de limpiar cualquier tipo de conducto antiguo antes de instalar su secadora nueva.** Si no se siguen estas instrucciones se podrá producir incendio o muerte.
- **Se recomiendan conductos rígidos o semirígidos para usar entre la secadora y la pared. En instalaciones particulares cuando es imposible realizar una conexión siguiendo las recomendaciones antes indicadas, únicamente se puede utilizar un conducto metálico de transición aprobado por UL entre la secadora y la conexión de pared. Usar este tipo de conducto afectará el tiempo de secado.** Si no se siguen estas instrucciones se podrá producir incendio o muerte.
- **NO utilice tornillos de lámina de metal ni otro tipo de aseguradores que se extiendan dentro del conducto y puedan atrapar pelusa y reducir la eficiencia del sistema de escape.** Asegure todas las uniones con cinta adhesiva impermeable. Para más detalles, siga las Instrucciones de Instalación. Si no se siguen estas instrucciones se podrá producir incendio o muerte.

### ⚠️ ADVERTENCIA

#### Riesgo de incendio

Si no se observan estrictamente las advertencias de seguridad, pueden producirse daños materiales, lesiones graves o la muerte.

No instale un ventilador auxiliar en el tubo de salida.

Instale todas las secadoras de ropa conforme a las instrucciones de instalación del fabricante de la secadora.

## INSTRUCCIONES DE SEGURIDAD PARA FUNCIONES DE VAPOR

### ⚠️ ADVERTENCIA

Para reducir el riesgo de incendio, descarga eléctrica o lesiones personales al usar este electrodoméstico deben seguirse precauciones básicas de seguridad, incluyendo las siguientes:

- **No abra la puerta de la secadora durante los ciclos de vapor.** No seguir estas instrucciones puede provocar un peligro de quemaduras.
- **No seque artículos que previamente se hayan limpiado, lavado, sumergido o manchado con gasolina, solventes para limpieza en seco u otras sustancias inflamables o explosivas ya que emanan vapores que podrían prenderse fuego o explotar.** No seguir estas instrucciones puede provocar un incendio o la muerte.
- **No llene el alimentador de vapor con gasolina, solventes para limpieza en seco u otras sustancias inflamables o explosivas.** No seguir estas instrucciones puede provocar un incendio o la muerte.
- **No toque la boquilla de vapor del tambor durante o después del ciclo de vapor.** No seguir estas instrucciones puede provocar un peligro de quemaduras.
- **No llene el alimentador de vapor con agua caliente (más de 86° F / 30° C).** No seguir estas instrucciones puede provocar un peligro de quemaduras.

# INSTRUCCIONES IMPORTANTES DE SEGURIDAD

## LEA TODAS LA INSTRUCCIONES ANTES DE USAR

### ADVERTENCIA

Por su seguridad, debe seguir la información indicada en este manual para minimizar el riesgo de incendio o explosión, descarga eléctrica, o para prevenir daños a la propiedad, lesiones personales o muerte.

## INSTRUCCIONES IMPORTANTES PARA CONECTAR LA ELECTRICIDAD

### ADVERTENCIA

Para reducir el riesgo de incendio, descargas eléctricas o heridas al usar su electrodoméstico, siga las precauciones básicas, incluyendo lo siguiente:

- **Bajo ninguna circunstancia, corte o quite la tercera pata (puesta a tierra) del cable eléctrico.** Para evitar heridas a nivel personal o daños sobre la secadora, el cable de corriente eléctrica debe estar conectado en una conexión a tierra en condiciones adecuadas.
- **Por motivos de seguridad personal, este electrodoméstico debe estar conectado a tierra adecuadamente.** Si esto no se cumple se podrán producir descargas eléctricas o heridas.
- **Consulte las instrucciones de instalación de este manual para obtener los requisitos eléctricos específicos de su modelo.** Si estas instrucciones no se cumplen se podrán producir descargas eléctricas y/o riesgo de incendio.
- **Esta secadora debe estar enchufada a un tomacorriente conectado a tierra adecuadamente. Si la secadora no se encuentra adecuadamente conectada a tierra se pueden producir descargas eléctricas. Contrate a un electricista calificado para que controle el tomacorriente y el circuito eléctrico para asegurarse que el enchufe está correctamente conectado a tierra.** Si estas instrucciones no se cumplen se podrán producir descargas eléctricas y/o riesgo de incendio.
- **La secadora siempre debe estar enchufada a su tomacorriente individual, con la clasificación de tensión correspondiente a la placa de datos de servicio.** Esto proporciona el mejor desempeño y previene a la vez sobrecarga de los circuitos de cableado del hogar, lo que podría producir un incendio debido a los cables sobrecalentados.
- **Nunca desenchufe su secadora empujando el cable de corriente. Siempre tome su enchufe firmemente y empuje el mismo hacia fuera para retirarlo.** El cable de corriente se puede cortar debido a cualquier movimiento de su parte central, resultando en una descarga eléctrica.
- **Repare o reemplace de inmediato todos los cables de corriente pelados o con cualquier tipo de daño. No use un cable con cortaduras o abrasión sobre su extensión o extremos.** Este cable de corriente se puede fundir, creando descargas eléctricas y/o riesgo de incendio.
- **Al instalar o cambiar de lugar la secadora, evite todo tipo de cortes u otros daños en el cable de corriente.** Esto evitará heridas o daños debido a incendios o descargas eléctricas sobre la secadora.

**GUARDE ESTAS INSTRUCCIONES**



# INFORMACIÓN TRANSMISOR MÓDULO

## Especificaciones módulo LAN inalámbrico

Modelo	LCW-003
Rango de frecuencia	2412~2462 MHz
Rango de frecuencia (max.)	IEEE 802.11 b : 17.56 dBm IEEE 802.11 g : 25.53 dBm IEEE 802.11 n : 25.29 dBm

### Nota de la FCC (Para el módulo trasmisor contenido en este producto)

Este equipo fue probado y se determinó que cumple con los límites para los dispositivos digitales de Clase B, en conformidad con la parte 15 de las normas de la FCC. Estos límites están diseñados para ofrecer una protección razonable contra interferencias dañinas en una instalación residencial.

Este equipo genera, usa y puede emitir energía de radiofrecuencia y, si no se instala y utiliza de acuerdo con las instrucciones, podría causar interferencias dañinas a las comunicaciones por radio. Sin embargo, no se garantiza que dicha interferencia no pueda ocurrir en instalaciones particulares. Si este equipo causa interferencia dañina a la recepción de radio o televisión, que se puede determinar encendiendo y apagando el equipo, se aconseja al usuario intentar corregir la interferencia realizando alguna de las siguientes acciones:

- Reorientar o reubicar la antena receptora.
- Aumentar la separación entre el equipo y el receptor.
- Conectar el equipo a una toma de corriente en un circuito diferente del utilizado por el receptor.
- Consultar al vendedor o a un técnico de radio/TV con experiencia para solicitar ayuda.

Este dispositivo cumple con la parte 15 de las normas de la FCC. La operación está sujeta a las dos siguientes condiciones:

- 1) Este dispositivo no debe causar interferencia dañina, y
- 2) Este dispositivo debe aceptar cualquier interferencia recibida, incluso aquellas que pudieran causar un funcionamiento no deseado del dispositivo.

Cualquier cambio o modificación en la construcción de este dispositivo que no cuente con la aprobación expresa de la parte responsable del cumplimiento, puede anular la autorización del usuario para operar este equipo.

## Declaración sobre exposición a la radiación de RF de la FCC

Este equipo cumple con los límites de exposición a la radiación de la FCC establecidos para entornos no controlados. Este transmisor no se debe ubicar ni operar junto con ninguna otra antena ni transmisor.

El equipo se debe instalar y operar con una distancia mínima de 20 cm (7,8 pulg.) entre la antena y su cuerpo. Los usuarios deben seguir las instrucciones de operación específicas de manera tal de cumplir con las normas de exposición a la RF.

## Información de anuncio de programas de código abierto

Para obtener el código fuente bajo GPL, LGPL, MPL y otras licencias de código abierto que contiene este producto, visite <http://opensource.lge.com>. Además del código fuente, se pueden descargar los términos de la licencia, las anulaciones de la garantía y los avisos de derechos de autor.

LG Electronics también le proporcionará el código fuente abierto en un CD-ROM con un cargo que cubra el costo de realizar tal distribución (como el costo de los medios, el envío y el manejo) con una previa solicitud por correo electrónico a [opensource@lge.com](mailto:opensource@lge.com). Esta oferta es válida durante tres (3) años a partir de la fecha de adquisición del producto.

## CARACTERÍSTICAS ESPECIALES

### PANEL DE CONTROL FÁCIL PARA USAR

Gire la perilla selectora de ciclos al ciclo de secado deseado. Añada los ajustes de ciclo o programe las opciones con el toque de un botón.

### PUERTA REVERSIBLE DE FÁCIL ACCESO

La amplia puerta provee acceso para carga y descarga. Se puede invertir el sentido de la puerta para adaptarlo al lugar de la instalación.

### TAMBOR DE ACERO INOXIDABLE DE CAPACIDAD SUPERIOR ILUMINADO

El tambor de acero inoxidable de gran capacidad ofrece durabilidad superior. El tambor está equipado con una luz amarilla que se ilumina al abrir la puerta de la secadora y se apaga cuando se cierra.

### FUNCIONES DE VAPOR ÚTILES

La nueva tecnología de vapor de LG le permite inyectar las telas con un chorro giratorio de vapor caliente para refrescar las prendas. Simplemente seleccione el ciclo steam fresh™ o agregue la opción Steam (vapor) a los ciclos seleccionados.

### INDICADOR DEL SISTEMA DE SENSOR DE BLOQUEO DE CONDUCTO FLOW SENSE™

El sistema de detección de bloqueo de conductos FLOW SENSE™ detecta y alerta sobre la existencia de obstrucciones en el sistema de ventilación doméstico instalado que reducen el flujo de ventilación de la secadora. Si aparece el mensaje de alerta: Limpie o repare los conductos para eliminar las obstrucciones. Mantenga sus conductos limpios para aumentar la eficiencia y reducir largos ciclos de secado causados por conductos bloqueados.

### SMART THINQ™

**Inicio remoto** - use un teléfono inteligente para controlar su electrodoméstico en forma remota. También es posible monitorear el funcionamiento del ciclo para saber cuánto tiempo le queda al ciclo.

**Mensaje inteligente** - cuando el ciclo esté completo o el electrodoméstico tenga problemas, tiene la opción de recibir notificaciones automáticas en su teléfono inteligente.

**Red inteligente** - los dispositivos inteligentes se pueden comunicar con las empresas locales proveedoras de servicios que cuentan con equipos de redes inteligentes. (Consulte la página 33).

**Descarga de ciclo** - descargue ciclos nuevos y especiales que no estén incluidos en la máquina.

**Smart Diagnosis™** - si llegase a experimentar dificultades técnicas, su dispositivo tiene la capacidad de transmitir los datos por teléfono al Centro del Información al Cliente para que se pueda diagnosticar el problema.

**Configuración del ciclo** - esta función configura automáticamente los parámetros del ciclo en función de sus necesidades de lavado.

**Estadísticas de lavado** - Esta función permite la temporización de la limpieza de la cuba Limpieza de tambor y el historial del uso de ciclos de la máquina.

**Monitoreo de la energía** - el consumo energético de su secadora se ve afectado por el ciclo y las configuraciones, por lo que se pueden observar algunos cambios en el consumo energético de un ciclo a otro.



**Protocolo P154**  
Ejecución de saneamiento de  
secadoras residenciales

# DESCRIPCIÓN DEL PRODUCTO

## PIEZAS Y ACESORIOS

### Partes

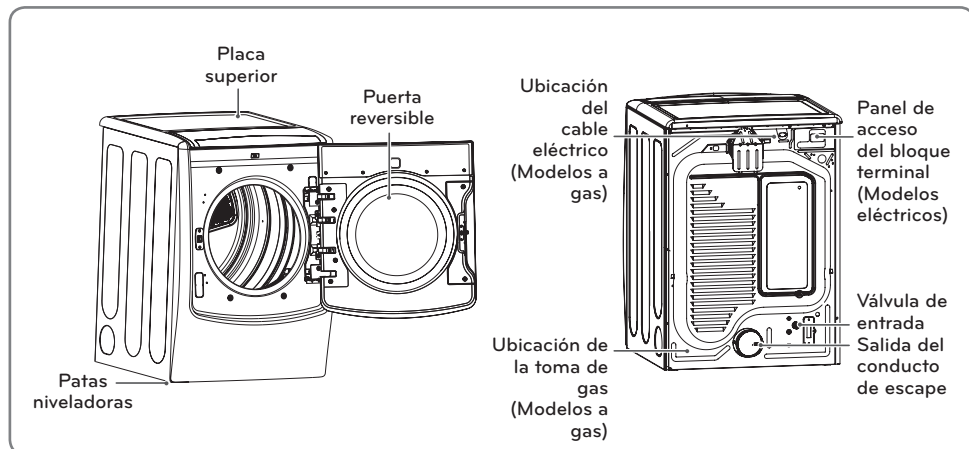

### Accesorios

#### Accesorios incluidos



Y conector

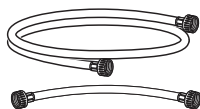

Manguera

#### Accesorios opcionales



Secado en parrilla  
(AHB73109002)

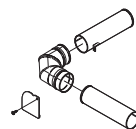

Side vent kit  
(sold separately)  
N.º de kit 383EEL9001B

### ! NOTA

- Visita [www.lg.com](http://www.lg.com) por comprar si falta alguno de los accesorios.
- Póngase en contacto con el Departamento de atención al cliente de LG, en el número 1-800-984-6306 (1-888-542-2623 en Canadá) si falta alguno de los accesorios.
- Para su seguridad, y con el fin de ampliar la vida útil de su lavadora, utilice sólo componentes autorizados. El fabricante no se hace responsable de los fallos del producto o accidentes causados por la utilización de piezas o componentes no autorizados.
- Las imágenes de esta manual pueden no coincidir con los componentes y accesorios reales, y están sujetas a cambios sin previo aviso para mejoras en el producto.

## Características del panel de control

A continuación encontrará instrucciones para comenzar a usar su secadora nueva. Para más información por favor consulte las secciones específicas de este manual.

**⚠️ ADVERTENCIA:** Para reducir el riesgo de incendios, descargas eléctricas o heridas, lea este manual en su totalidad, incluyendo las Instrucciones Importantes de Seguridad, antes de operar la secadora.

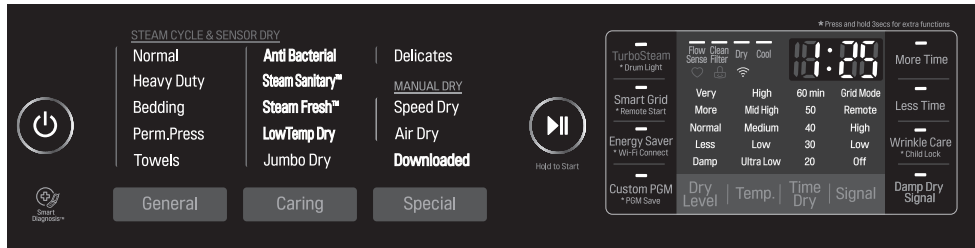

## Operación

Botón	Descripción
	<p><b>BOTÓN DE ENCENDIDO/APAGADO (ON/OFF)</b></p> <ul style="list-style-type: none"> <li>- Apriete el botón para encender la secadora. Para apagar la secadora, manténgalo presionado por más de 0,4 segundos.</li> <li><b>NOTA:</b> Apretar el botón de ENCENDIDO/APAGADO (ON/OFF) durante un ciclo cancelará ese ciclo y borrará cualquier ajuste de carga.</li> </ul>
	<p><b>BOTONES SELECTORES DE CICLOS</b></p> <ul style="list-style-type: none"> <li>- Los ciclos están dispuestos según el tipo de secado.</li> <li>- Presione los botones repetidamente para pasar por los ciclos disponibles.</li> <li>- El nombre del ciclo se ilumina cuando se lo selecciona.</li> </ul>
	<p><b>BOTÓN DE INICIO/PAUSA (START/PAUSE)</b></p> <ul style="list-style-type: none"> <li>- Mantenga presionado este botón por más de 0,5 segundos para iniciar el ciclo seleccionado. Si la secadora está funcionando, utilice este botón para hacer una Pausa en el ciclo, sin perder los ajustes actuales.</li> <li><b>NOTA:</b> Si no aprieta el botón Inicio/Pausa (Start/Pause) para detener un ciclo en 4 minutos, la secadora se apagará automáticamente.</li> </ul>
	<p><b>BOTONES DE MÁS TIEMPO/MENOS TIEMPO (MORE TIME/LESS TIME)</b></p> <ul style="list-style-type: none"> <li>- Use estos botones con los ciclos de secado manual (MANUAL DRY), de SECADO TEMPORIZADO (TIME DRY), y de STEAM FRESH™ programar el tiempo de secado. Apriete el botón MÁS TIEMPO (MORE TIME) para aumentar el tiempo del ciclo manual seleccionado en intervalos de un minuto; apriete MENOS TIEMPO (LESS TIME) para disminuir el tiempo del ciclo en intervalos de un minuto.</li> </ul>
	<p><b>BOTONES DE AJUSTE DE CICLOS</b></p> <ul style="list-style-type: none"> <li>- Utilice estos botones para seleccionar los ajustes de ciclo deseados para el ciclo seleccionado. Los ajustes actuales se muestran en la pantalla. Apriete el botón para ver esa opción y seleccionar otros ajustes.</li> </ul>
	<p><b>BOTONES DE OPCIONES</b></p> <ul style="list-style-type: none"> <li>- Los botones de opciones le permiten seleccionar opciones de ciclo adicionales. No todos los ajustes pueden usarse en todos los programas. Consulte la sección GUIA DE CICLOS de este manual.</li> </ul>
<p>Steam Sanitary™</p> <p>Steam Fresh™</p>	<p><b>FUNCIONES ÚTILES CON VAPOR</b></p> <ul style="list-style-type: none"> <li>- La nueva tecnología con vapor de LG le permite inyectar a la ropa un chorro de vapor caliente en forma de remolino, el cual permite refrescar la misma, reducir la estática y facilitar el planchado. Simplemente seleccione el ciclo STEAM FRESH™, STEAM SANITARY™ o puede agregar la opción VAPOR a ciclos seleccionados. Para obtener información detallada sobre opciones individuales, lea las siguientes páginas.</li> </ul>

## Pantalla

La pantalla muestra los ajustes, el tiempo restante estimado, las opciones y los mensajes de estado correspondientes a su secadora. Cuando se gira el secador, la luz en la exhibición iluminará.

**⚠️ ADVERTENCIA:** Para reducir el riesgo de incendios, descargas eléctricas o heridas, lea este manual en su totalidad, incluyendo las Instrucciones Importantes de Seguridad, antes de operar la secadora.

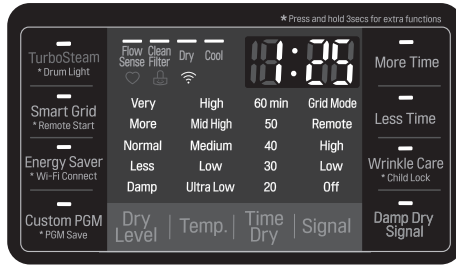

Pantalla y los iconos	Descripción
	<b>TIEMPO RESTANTE ESTIMADO (ESTIMATED TIME REMAINING)</b> - Cuando se mantiene presionado el botón de Inicio (Start), la secadora indica el tiempo estimado [SECADO CON SENSOR (SENSOR DRY)] o establecido [SECADO DE TIEMPO (TIME DRY)] restante y comienza a girar la ropa en su interior. <b>NOTA :</b> El tiempo de ciclo en los ciclos SECADO CON SENSOR (SENSOR DRY) podrían fluctuar a medida que la secadora vuelve a calcular el tiempo de secado para obtener resultados óptimos.
	<b>INDICADOR DE FINALIZACIÓN DE CICLO CON RECORDATORIO DE CONTROL DE FILTRO</b> - Esta opción de la pantalla muestra qué etapa del ciclo de secado se está llevando a cabo: REVISIÓN DE FILTRO (CLEAN FILTER), SECADO(DRY), FRIAMIENTO (COOL).
	<b>INDICADOR DE CERRADURA A PRUEBA DE NIÑOS (CHILD LOCK)</b> - Cuando se ha fijado el seguro infantil, aparecerá el indicador de seguro infantil y se desactivarán todos los botones excepto el botón de ENCENDIDO/APAGADO (ON/OFF). Esto previene que los niños cambien los ajustes mientras la secadora se encuentra en funcionamiento.
	<b>RECORDATORIO DE REVISIÓN DE FILTRO (CLEAN FILTER REMINDER)</b> - La pantalla mostrará REVISIÓN DE FILTRO (CLEAN FILTER) cuando se ha encendido la secadora como un recordatorio para revisar el filtro. Se apaga cuando se aprieta el botón INICIO/PAUSA (START/PAUSE)
	<b>PROGRAMA PERSONALIZADO (CUSTOM PROGRAM)</b> - Si usted tiene una combinación especial de configuraciones que utiliza con frecuencia, puede guardarlas como PRO GRAMA PERSONALIZADO (CUSTOM PROGRAM)
	<b>INDICADOR DEL SISTEMA DE SENSOR DE BLOQUEO DE CONDUCTO FLOW SENSE™</b> - El sistema de sensor de bloqueo de conducto FLOW SENSE™ detecta y lo alerta sobre bloqueos y la tubería, lo cual reduce el flujo de escape de la secadora. Esto puede mejorar el funcionamiento y ayudar a minimizar el número de llamadas al servicio técnico, ahorrándole dinero.
	<b>Indicador de conexión Wi-Fi</b> - Cuando el electrodomestico este conectado a Internet a través de la red Wi-Fi de su hogar, aparecera este indicador.

# INSTALACIÓN

## Descripción de la instalación

ESPAÑOL

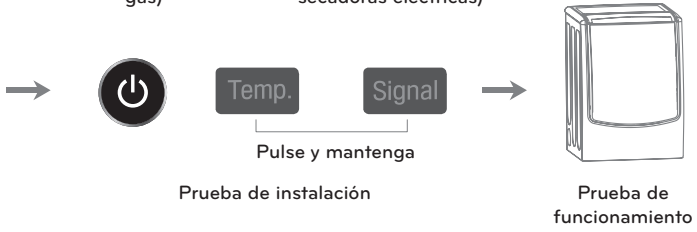
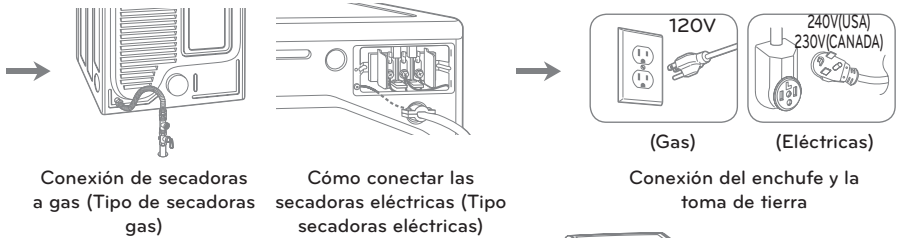
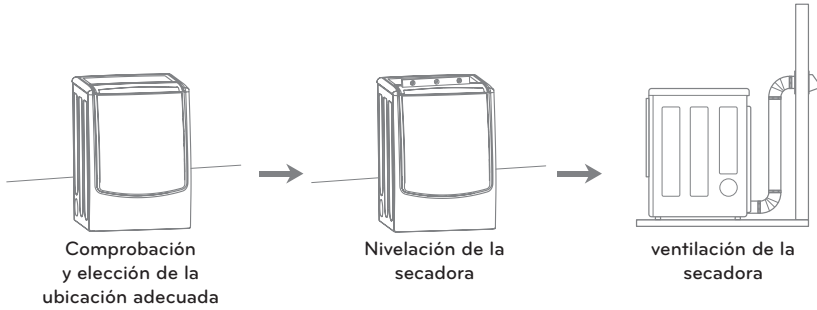

## Requisitos del lugar de instalación

### ⚠ ADVERTENCIA

**Siga las instrucciones de funcionamiento y cuidado incluidas en este manual y conseguirá que su secadora ofrezca un servicio fiable y duradero.** Es importante que revise todo este manual antes de instalar y usar su secadora. Se proporcionan instrucciones detalladas pertinentes a las conexiones eléctricas, de gas y los requisitos de escape en las siguientes páginas.

- Un lugar que permita la instalación correcta del sistema de escape. El secador de gas debe tener una salida de escape hacia el exterior. Consulte **Conexión del conducto de ventilación de la secadora**.
- La salida eléctrica de toma a tierra debe estar a 61 cm (2 pies) de ambos lados de la secadora. Consulte **Cómo conectar las secadoras eléctricas**.
- El suelo debe ser firme para soportar el peso total de la secadora, siendo éste de 90,7 kg (200 lbs). Igualmente, se tendrá en cuenta el peso combinado de un posible electrodoméstico acoplado.
- No se puede instalar ningún aparato de combustión en el mismo compartimento que la secadora.

No utilice la secadora a temperaturas inferiores a 7°C (45°F). A temperaturas bajas, la secadora puede no apagarse al final de un ciclo automático. Esto puede conllevar a tiempos de secado más largos. La secadora no se debe instalar ni almacenar en una zona donde pueda estar expuesta al agua o a inclemencias meteorológicas. Compruebe los requisitos del código. Algunos códigos limitan, o no permiten, la instalación de la secadora en garajes, muebles cerrados, caravanas o dormitorios. Contacte con la persona encargada de la inspección de su edificio.

### ! NOTA

- El suelo de apoyo de la secadora debe estar nivelado y no tener una inclinación superior a 2,5 cm (1 pulg.). Si la secadora no está nivelada, las prendas no se centrifugarán correctamente y los ciclos de sensor automático puede que no funcionen como corresponde.
- Para la instalación en un garaje, necesita colocar la secadora a 46 cm (18 pulg.) como mínimo del suelo. Si utiliza un pedestal, debe dejar una separación de 46 cm (18 pulg.) respecto a la parte inferior de la secadora.

## Espacios de instalación

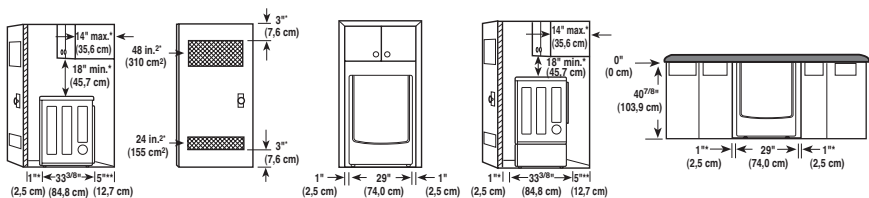

### SEPARACIÓN AL REALIZAR LA INSTALACIÓN EN ÁREAS CERRADAS O EMPOTRADAS

Para esta secadora, se recomienda dejar las siguientes separaciones. Esta secadora se ha evaluado dejando una separación de 2,5 cm (1 pulg.) a ambos lados y en la parte posterior. Se recomienda dejar el espacio recomendado, por las razones siguientes:

- Se debe dejar un espacio adicional para facilitar las tareas de instalación y mantenimiento.
- Las separaciones adicionales pueden ser necesarias para las molduras del techo, el suelo o la pared.
- Igualmente se deben considerar las separaciones a ambos lados de la secadora para reducir la transmisión de ruido. Al realizar la instalación en un armario o habitáculo cerrado, debe haber salidas de ventilación mínimas en la parte superior e inferior del lugar. También se permiten las puertas apersianadas con salidas de ventilación equivalentes.
- Además debe tenerse en cuenta el espacio requerido por cualquier otro aparato que se acompañe.

### ! NOTA

Al menos se debe dejar un espacio alrededor de la secadora (o de cualquier otro equipo) para eliminar la transferencia de vibración de uno a otro. Si la vibración es importante, podría desencadenar ruidos o fricción entre ambos, con el consecuente deterioro de la pintura e incluso, más ruido.

## Separaciones con base pedestal opcional

### SEPARACIÓN RECOMENDADA PARA LA INSTALACIÓN EN UN HABITÁCULO CERRADO

- Al realizar la instalación en un habitáculo cerrado debe haber salidas de ventilación mínimas en la parte superior e inferior del lugar.

\*Espacio requerido

\*\* Para la ventilación lateral e inferior, se permite una separación de 5,1 cm (2 pulg.)

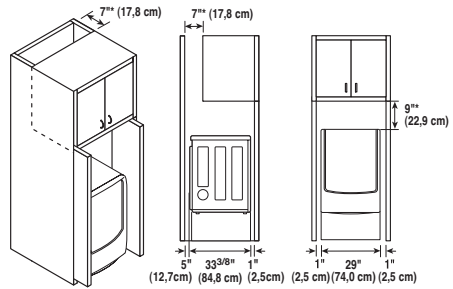



## Nivelación de la secadora

### ⚠ ADVERTENCIA

- **Para reducir el riesgo de lesiones personales, cumpla con todos los procedimientos de seguridad recomendados por la industria, incluyendo el uso de guantes con mangas largas y gafas de seguridad.** Si no se cumple con esta advertencia se podrán producir heridas graves o muerte.
- **Los aparatos son pesados. Se necesitan dos o más personas para la instalación de la secadora.** Si no se cumple con esta advertencia se podrán producir heridas graves o muerte.

Para asegurar que la secadora brinde un desempeño óptimo de secado, debe estar nivelada. Para minimizar la vibración, el ruido y movimiento no deseados, el piso deberá ser una superficie perfectamente nivelada y sólida.

### ! NOTA

Fije las patas niveladoras sólo en la medida necesaria para nivelar la secadora. La extensión de las patas niveladoras más de lo necesario puede causar vibración de la secadora.

1. Coloque la secadora en la posición final. Coloque un nivelador sobre la secadora.

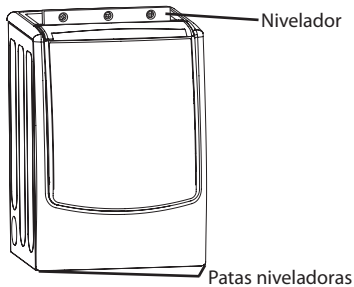

- Las 4 patas niveladoras deberán apoyarse firmemente en el piso. Empuje suavemente las esquinas superiores de la secadora para asegurarse de que su secadora no se mece de esquina a esquina.

Si está instalando la secadora sobre el accesorio de pedestal opcional, deberá usar las patas niveladoras del pedestal para nivelarla. Las patas niveladoras de la secadora deberán estar completamente retraídas.

2. Use una llave de tuercas ajustable para girar las patas niveladoras. Gire en la dirección de las manecillas del reloj para levantar la secadora o en dirección contraria para bajarla. Suba o baje las patas niveladoras hasta que la secadora esté nivelada de lado a lado y de adelante hacia atrás. Asegúrese de que las 4 patas niveladoras se encuentran haciendo contacto firme con el piso.

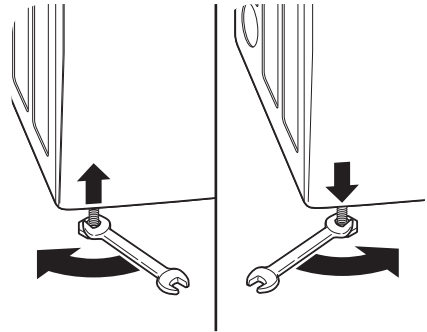

## Inversión de la puerta

### ⚠️ ADVERTENCIA

LA PUERTA DE LA SECADORA ES MUY GRANDE Y PESADA. Necesitará contar con dos o más personas para invertir la puerta. El incumplir las instrucciones siguientes puede dañar la secadora, ocasionar daños materiales o lesiones personales.

- Para evitar daños en la secadora o en la puerta, apoye la puerta sobre un taburete o una caja de un tamaño acorde o pida a otra persona que sujete la puerta mientras realiza este procedimiento.
- Siempre invierta la puerta ANTES de apilar la secadora sobre una lavadora.
- Evite que la puerta se caiga para que no se produzcan daños en la puerta o en el suelo.

**Herramientas necesarias:** destornillador plano, destornillador Phillips

### Antes de comenzar

1. Desconecte la máquina o apague la fuente de alimentación desde el circuito principal antes de invertir la puerta. Abra la puerta de la secadora

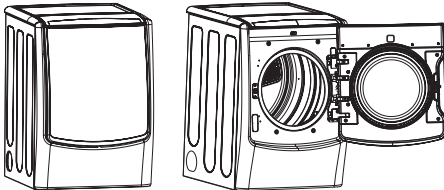

### ⚠️ ADVERTENCIA

Asegúrese de sostener el peso de la puerta antes de extraer los tornillos de la bisagra.

### Extraer la puerta

1. Mientras sostiene la puerta, extraiga los cuatro tornillos de la bisagra.
2. Cuidadosamente, ponga la puerta a un lado del armazón para descubrir el arnés de cables que se encuentra detrás de la bisagra, en la parte superior. Presione la lengüeta de bloqueo lateral para desconectar el conector del arnés de cables. La atadura de alambre y la tapa deben evitar que el arnés de cables se retraiga dentro del armazón.
3. Extraiga la puerta de la cubierta del armazón. Colóquela mirando hacia abajo en una superficie de trabajo protegida.

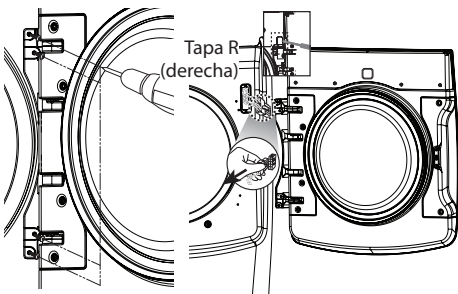

### Invertir la bisagra y el pestillo de la puerta

1. Extraiga los cuatro tornillos del marco de la puerta derecho (manija y pestillo), levántelos hacia afuera y coloque las partes a un lado. (Los dos tornillos centrales del pestillo son más largos).
2. Quite los cuatro tornillos del marco izquierdo de la puerta (ensamble de la bisagra).
3. Con cuidado, levante el ensamble de la bisagra para descubrir el conector del arnés de cables en la parte superior de la bisagra. Presione la lengüeta de bloqueo central para desconectar el conector del arnés de cables.
4. Gire el ensamble de la bisagra 180 grados y conecte el arnés de cables al conector en la parte inferior derecha de la puerta.
5. Instale el ensamble de la bisagra en el espacio de la parte lateral derecha de la puerta, introduciendo el arnés de cables en la esquina para hacer lugar. Inserte y apriete los cuatro tornillos.
6. Gire la manija que extrajo en el paso uno 180 grados e instálela en el lateral izquierdo de la puerta con los dos tornillos más cortos. Use los tornillos más largos para ajustar el pestillo de la puerta en el centro.

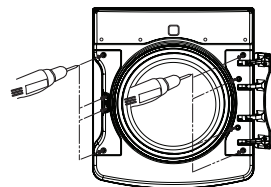
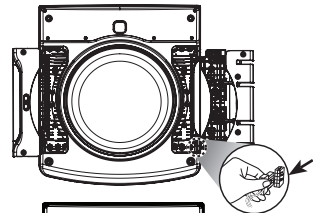
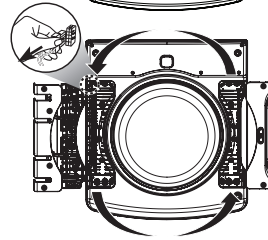
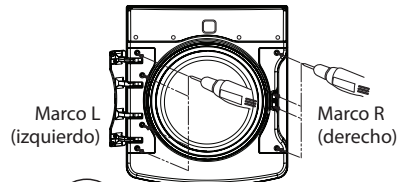

**Invertir los componentes del armazón**

1. Quite los dos tornillos y el ensamble del cerrojo del lateral izquierdo de la abertura.
2. Gire el ensamble del cerrojo y colóquelo en el lado derecho de la abertura con los dos tornillos.
3. Intercambie las dos tapas. Desate la atadura de alambre y quite la pequeña tapa del lateral del arnés de cables en la parte superior derecha del armazón. Asegúrese de que el arnés de cables no se deslice hacia adentro del armazón.
4. Quite la tapa izquierda haciendo palanca suavemente con un destornillador plano, con cuidado de no marcar la pintura. Desconecte el arnés de cables unido a la tapa presionando las lengüetas en cualquiera de los lados.
5. Ajuste la tapa izquierda al arnés de cables en la parte superior izquierda del armazón. Presione la tapa hasta que se trabe en su lugar.
6. Ajuste la atadura de alambre y la tapa pequeña que extrajo en el paso 1 al lateral del arnés de cables, en la parte inferior izquierda del armazón. El arnés de cables se sujetará al arnés de la puerta.
7. Desatornille los cuatro tornillos decorativos de la parte izquierda del armazón e insértelos en los orificios correspondientes de la parte derecha.

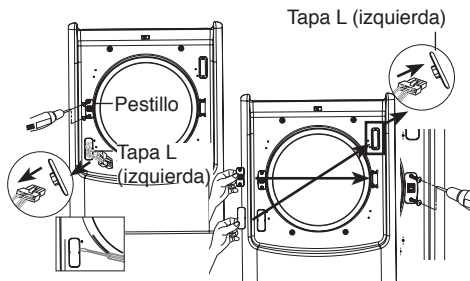
**⚠ ADVERTENCIA**

Asegúrese de sostener el peso de la puerta mientras inserta los tornillos de bisagra.

**Montaje de la puerta**

1. Alinee la bisagra con los orificios de montaje.
2. Mientras sostiene la puerta, ajuste los cuatro tornillos de la bisagra.

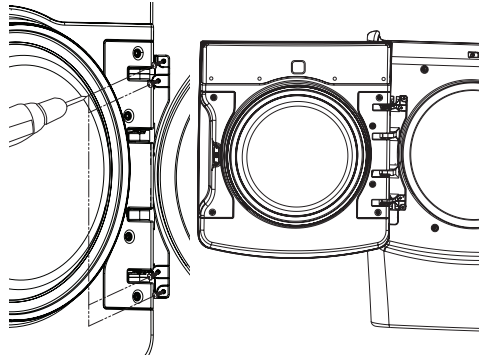
**Verificación final**

1. Compruebe que la puerta se cierre y se trabe de manera adecuada.

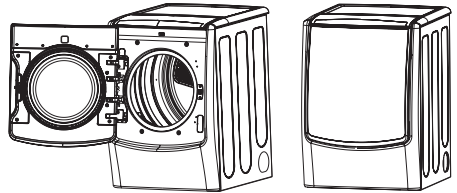
**Preparación para montar la puerta nuevamente**

1. Mientras sostiene la puerta, colóquela en posición con la bisagra en el lado izquierdo.
2. Conecte el arnés de cables de la bisagra al conector en la parte inferior izquierda del armazón.

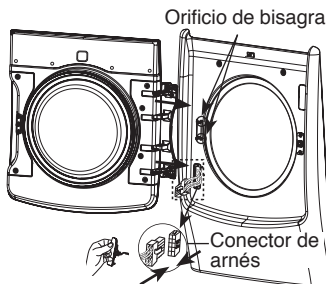

## Instalación del kit de ventilación lateral

### ⚠️ ADVERTENCIA

- **Utilice material para ventilación de metal pesado.**
- **No utilice conductos de plástico o aluminio delgado.**
- **Limpie los conductos antiguos antes de instalar esta secadora.**
- **Para reducir el riesgo de lesiones personales, cumpla con todos los procedimientos de seguridad recomendados por la industria, incluyendo el uso de guantes con mangas largas y gafas de seguridad.**
- En caso de no cumplir con todas las advertencias de seguridad de este manual se podrán producir daños sobre la propiedad, lesiones personales o la muerte.

Su secadora está equipada de fábrica para ventilar en la parte trasera. También puede configurarse para ventilar en la parte inferior o lateralmente (no está disponible la ventilación del lado derecho en los modelos a gas).

Puede adquirirse el kit adaptador, número de pieza **383EEL9001B**, de su distribuidor LG. Este kit contiene los componentes de conducto necesarios para cambiar la ubicación de la ventilación de la secadora.

1. Retire el tornillo de seguridad del conducto de escape trasero. Saque el conducto de escape.

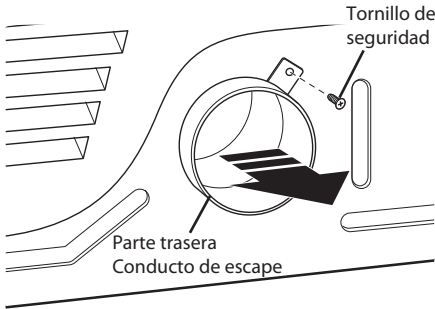

### OPCIÓN 1: VENTILACIÓN LATERAL

2. Apriete las lengüetas en el dispositivo de expulsión y retírelo cuidadosamente para obtener la ventilación adecuada (no está disponible ventilación lateral en los modelos a gas). Apriete el conducto adaptador en la carcasa del ventilador y asegure la base de la secadora como se indica.

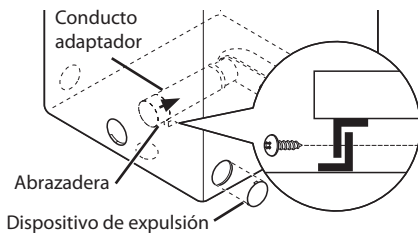

3. Conecte un codo de 4 pulgadas (10,2 cm) a la siguiente sección de conducto de 4 pulgadas (10,2 cm), y asegure todas las conexiones con cinta adhesiva impermeable. Asegúrese de que el extremo macho del codo apunte hacia AFUERA de la secadora. Inserte el montaje de codo/conducto a través de la abertura lateral y presiónelo en el conducto adaptador. Asegúrelo en su lugar con cinta adhesiva impermeable. Asegúrese de que el extremo macho del conducto sobresalga 1 1/2 pulgadas (3,8 cm) para conectar el resto del sistema de ventilación. Conecte la placa de cubierta a la parte trasera de la secadora con el tornillo provisto.

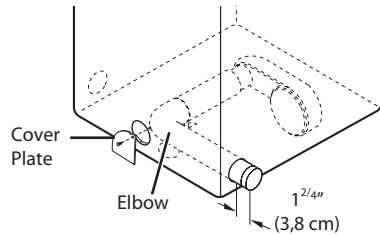

### OPCIÓN 2: VENTILACIÓN INFERIOR

2. Apriete el conducto adaptador en la carcasa del ventilador y asegure la base de la secadora como se indica.

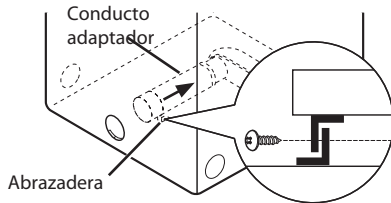

3. Inserte el codo de 4 pulgadas (10,2 cm) a través de la abertura trasera y apriételo en el conducto adaptador. Asegúrese de que el extremo macho y el codo apunten hacia abajo por el orificio ubicado en la parte inferior de la secadora. Asegúrelo en su lugar con cinta adhesiva impermeable. Conecte la placa de cubierta a la parte trasera de la secadora con el tornillo provisto.

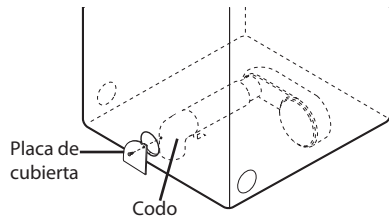

## Cónexión del conducto de ventilación de la secadora

### ⚠️ ADVERTENCIA

Para reducir el riesgo de incendio, descargas eléctricas o heridas al usar su electrodoméstico, siga las precauciones básicas, incluyendo lo siguiente:

- **No aplaste ni doble el sistema de conducto.** Si no se siguen estas instrucciones se podrá producir incendio o muerte.
- **No permita que el sistema de conducto se asiente sobre objetos puntiagudos ni entre en contacto con los mismos.** Si no se siguen estas instrucciones se podrá producir incendio o muerte.
- **Si conecta a un sistema de conducto existente, asegúrese de que sea adecuado y de que esté limpio antes de instalar la secadora.** Si no se siguen estas instrucciones se podrá producir incendio o muerte.
- **El sistema de ventilación debe seguir los códigos de construcción.** Si no se siguen estas instrucciones se podrá producir incendio o muerte.
- **Las secadoras de gas DEBEN ventilar hacia el exterior.** Si no se siguen estas instrucciones se podrá producir incendio o muerte.
- **Únicamente use un sistema de conducto rígido y de metal flexible de 10,2 cm (4 pulg.) dentro del gabinete de la secadora y para ventilación al exterior.** Si no se siguen estas instrucciones se podrá producir incendio o muerte.
- **Para reducir el riesgo de incendio, combustión o acumulación de gases combustibles, NO descargue el escape de la secadora en un área cerrada o no ventilada, tal como un desván, pared, cielo raso, espacio entre el cimientado y la tierra, chimenea, conducto de gas o espacios ocultos de un edificio.** Si no se siguen estas instrucciones se podrá producir incendio o muerte.
- **Para reducir el riesgo de incendio, NO descargue el escape de la secadora usando conductos de plástico ni de lámina metálica.** Si no se siguen estas instrucciones se podrá producir incendio o muerte.
- **El conducto de escape deberá tener 10,2 cm (4 pulg.) de diámetro sin obstrucciones. El conducto de escape deberá mantenerse lo más corto posible. Asegúrese de limpiar cualquier tipo de conducto antiguo antes de instalar su secadora nueva.** Si no se siguen estas instrucciones se podrá producir incendio o muerte.
- **Se recomiendan conductos rígidos o semirígidos para usar entre la secadora y la pared. En instalaciones particulares cuando es imposible realizar una conexión siguiendo las recomendaciones antes indicadas, únicamente se puede utilizar un conducto metálico de transición aprobado por UL entre la secadora y la conexión de pared. Usar este tipo de conducto afectará el tiempo de secado.** Si no se siguen estas instrucciones se podrá producir incendio o muerte.
- **NO utilice tornillos de lámina de metal ni otro tipo de aseguradores que se extiendan dentro del conducto y puedan atrapar pelusa y reducir la eficiencia del sistema de escape. Asegure todas las uniones con cinta adhesiva impermeable.** Si no se siguen estas instrucciones se podrá producir incendio o muerte.
- **Para maximizar los resultados de funcionamiento, siga las limitaciones de longitud del conducto indicadas en el cuadro de arriba.** Si no se siguen estas instrucciones se podrá producir incendio o muerte.
- **No se provee el sistema de ventilación con la secadora; el mismo deberá obtenerse localmente. La tapa terminal deberá tener reguladores de tiro con bisagras para prevenir el retorno de descarga cuando no se usa la secadora.** Si no se siguen estas instrucciones se podrá producir incendio o muerte.
- **La longitud total del conducto metálico flexible no deberá superar los 2,4 m (8 pies).**
- **En Canadá, sólo se deberán usar conductos flexibles de lámina de metal, si se precisasen, específicamente identificados por el fabricante para su uso con el electrodoméstico.** En EE.UU., sólo se deberán usar conductos flexibles de lámina de metal, si se precisasen, específicamente identificados por el fabricante para su uso con el electrodoméstico y que cumplan la "Outline for Clothes Dryer Transition Duct" (Directriz para conductos de transición de secadoras), Sujeto 2158A.

## Conexión del conducto de ventilación de la secadora (cont.)

### Sistema de conducto

TIPO DE TAPA DE PARED	NÚMERO DE CODOS DE 90°	LONG. MÁX. DE CONDUCTO METÁLICO FLEXIBLE DE DIÁM. 4"
 (10,2 cm)	0	65 ft. (19,8 m)
	1	55 ft. (16,8 m)
	2	47 ft. (14,3 m)
	3	36 ft. (11,0 m)
	4	28 ft. (8,5 m)
Solamente para el uso en las instalaciones de conducto cortos  2 1/4" (6,35 cm)	0	55 ft. (16,8 m)
	1	47 ft. (14,3 m)
	2	41 ft. (12,5 m)
	3	30 ft. (9,1 m)
	4	22 ft. (6,7 m)

#### ! NOTA

Reste 6 pies (1,8 m) por cada codo adicional. No se recomienda usar más de cuatro codos de 90°.

### DIRECCIONAMIENTO Y CONEXIÓN DEL SISTEMA DE CONDUCTO DE ESCAPE

#### ! NOTA

Siga las pautas indicadas más abajo para maximizar el desempeño de secado y reducir la acumulación de pelusa en el sistema de conducto.

El sistema de conducto y las conexiones NO están incluidas y deben adquirirse por separado.

- Use un sistema de conducto metálico rígido o semirígido de 10,2 cm (4 pulg.).
- El conducto de escape deberá tenderse lo más corto posible.
- Use la menor cantidad de conexiones de codo que sea posible.
- El extremo macho de cada sección del conducto de escape deberá apuntar hacia afuera de la secadora.
- Use cinta adhesiva impermeable en todas las conexiones de conducto.
- Aísle el sistema de conducto que se tiende a través de áreas sin calefacción para reducir la condensación y acumulación de pelusa en las superficies del conducto.
- Si no se instala correctamente la ventilación de escape de la secadora, se anulará la garantía.

### VENTILACIÓN DE ESCAPE CORRECTA

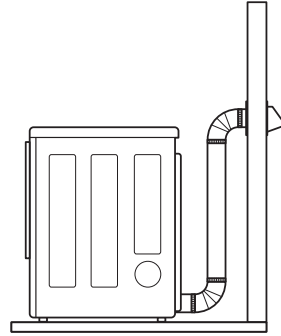

### VENTILACIÓN DE ESCAPE INCORRECTA

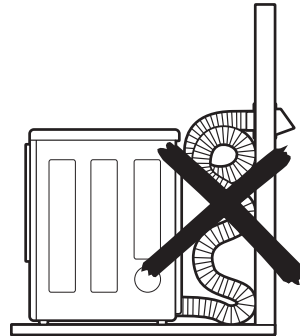

## Manguera de entrada

La secadora debe estar conectada al grifo de agua fría usando la manguera de suministro de agua nueva. No utilice la manguera de edad.

### ! NOTA

- La presión del agua de suministro debe estar entre 138 kPa y 827 kPa (1,4 a 8,5 kgf / cm<sup>2</sup>).
- No pele o cross-thread la manguera de entrada a la válvula.
- Si la presión de suministro de agua es más de 827 kPa, un dispositivo de descompresión debe ser instalado.
- Si controlar periódicamente el estado de la manguera y vuelva a colocar la manguera si es necesario.
- Sustituya las mangueras de entrada tras 5 años de uso afín de reducir el riesgo de fallo de la manguera.
- Anote las fechas de instalación o sustitución de la manguera en las mangueras para referencias futuras.

1. Compruebe la junta de goma en la manguera de entrada. Dos juntas de goma se suministran con cada manguera de entrada. Se utilizan para evitar fugas de agua. Asegúrese que la conexión al grifo de agua fría está apretada.

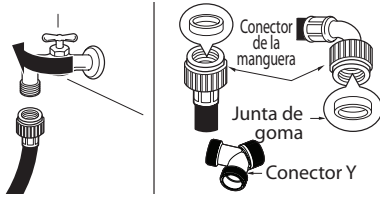

2. Compruebe el tipo de instalación.

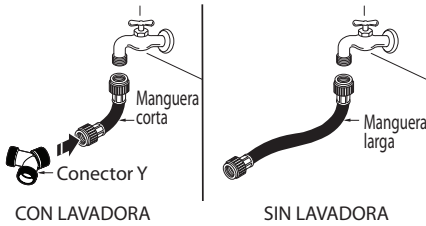

**Conecte todas las mangueras de suministro de agua firmemente a mano y después apriete de otras 2/3 vueltas con un alicate.**

**CON LAVADORA: cuando se conecta la secadora al mismo grifo que una lavadora.**

- Cierre el grifo del agua fría y retire la manguera de la lavadora.
- Conecte la manguera corta al conector Y mediante una de las mangueras de la lavadora.
- Conecte la otra extremidad de la manguera corta al grifo de agua fría.
- Conecte la manguera larga de la secadora a un lateral del conector Y y conecte la manguera de la lavadora al otro lateral.

**SIN LAVADORA: si la secadora no comparte el grifo de agua fría con una lavadora.**

- Conecte la extremidad recta de la manguera larga al grifo de agua fría.

### ! NOTA

- Antes de conectar la línea de agua a la secadora, enjuague con varios galones de agua dentro del desagüe o cubo. Esto ayudará a evitar que partículas extrañas como la arena o el sarro atasquen la válvula de entrada de la secadora.
- No apriete demasiado. El acoplamiento podría resultar dañado.

3. Conecte la manguera a la secadora.
- Conecte la manguera de suministro de agua a la válvula de entrada de la secadora firmemente a mano y después apriete de otras 2/3 vueltas con un alicate. Asegúrese que la mangueras no están retorcidas y que no están aplastadas.

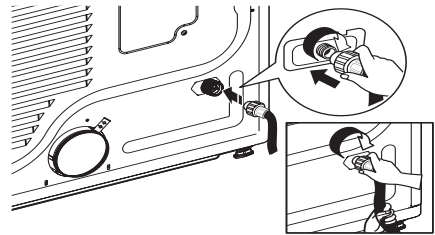

4. Abra el grifo de agua fría.

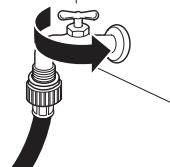

5. Compruebe si hay fugas en el conector Y (si se utiliza) y todas las mangueras.

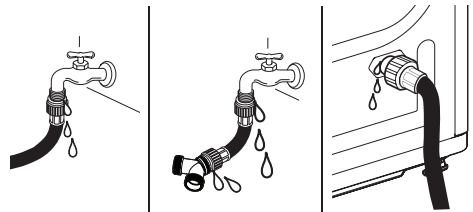

### ! NOTA

- Si se encuentra alguna fuga, cierre el grifo del agua, retire la manguera y compruebe el estado de la manguera de la arandela de la manguera.

## Conexión de secadoras a gas

### ⚠️ ADVERTENCIA

Para reducir el riesgo de incendio, descargas eléctricas o heridas al usar su electrodoméstico, siga las precauciones básicas, incluyendo lo siguiente:

- **Requisitos de suministro de gas:**  
**Como enviado de fábrica, si configura la secadora para uso con gas natural. Puede convertirse para usar con gas LP (propano líquido). La presión de gas no debe sobrepasar la columna de agua de 13 pulgadas.**
- **Un técnico calificado de mantenimiento o de la compañía de gas debe conectar la secadora al suministro de gas.** Si no se cumple con esto se podrá producir una explosión, incendio o muerte.
- **Aíse la secadora del sistema de suministro de gas cerrando su válvula de corte individual manual durante cualquier tipo de prueba de presión del suministro de gas.** Si no se cumple con esto se podrá producir una explosión, incendio o muerte.
- **Requisitos de la línea de suministro: Su cuarto de lavado debe tener una línea rígida de suministro de gas para la secadora. En los Estados Unidos, se DEBE instalar una válvula de corte manual individual a una distancia de, por lo menos, 6 pies (1.8 m) de la secadora, de acuerdo con el Código Nacional de Gas Combustible ANSI Z223.1 o el código canadiense de instalación de gas CSA B149.1. Se debe instalar un tapón de tubo de 1/8 pulgadas NPT.** Si no se cumple con esto se podrá producir una explosión, incendio o muerte.
- **Si se usa tubería rígida, la tubería rígida deberá ser de 1/2 pulgadas IPS. Si es aceptable según los códigos y las regulaciones locales, y cuando sea aceptable según su compañía proveedora de gas, se puede usar tubería de 3/8 pulgadas aprobada, cuando las longitudes sean menores de 20 pies (6,1 m). Se debe usar tubería más larga en caso de longitudes que exceden los 20 pies (6,1 m).** Si no se cumple con esto se podrá producir una explosión, incendio o muerte.
- **Conecte la secadora al tipo de gas indicado en la placa del nombre.** Si no se cumple con esto se podrá producir una explosión, incendio o muerte.
- **Para prevenir la contaminación de la válvula de gas, purgue el aire y sedimento del suministro de gas antes de conectar el suministro de gas a la secadora. Antes de ajustar la conexión entre el suministro de gas y la secadora, purgue el aire hasta que se detecte olor a gas.** Si no se cumple con esto se podrá producir una explosión, incendio o muerte.
- **NO use una llama abierta para inspeccionar las fugas de gas. Use un fluido anticorrosivo para detección de fugas.** Si no se cumple con esto se podrá producir una explosión, incendio o muerte.
- **Utilice únicamente una línea de suministro de gas nueva certificada por AGA o CSA, con conectores flexibles de acero inoxidable.** Si no se cumple con esto se podrá producir una explosión, incendio o muerte.
- **Ajuste bien todas las conexiones de gas.** Si no se cumple con esto se podrá producir una explosión, incendio o muerte.
- **NO intente desmontar ningún componente de la secadora; cualquier desmontaje requiere de la atención y herramientas de un técnico o compañía de mantenimiento autorizado y calificado.** Si no se cumple con esto se podrá producir una explosión, incendio o muerte.
- **Use un compuesto para conexiones de tubería insoluble en gas de petróleo líquido (LP) en todas las roscas de tubería.** Si no se cumple con esto se podrá producir una explosión, incendio o muerte.

### Requisitos eléctricos para modelos a gas únicamente

### ⚠️ ADVERTENCIA

Para reducir el riesgo de incendio, descargas eléctricas o heridas al usar su electrodoméstico, siga las precauciones básicas, incluyendo lo siguiente:

- **Bajo ninguna circunstancia, corte o quite la tercera pata (puesta a tierra) del cable eléctrico.** Si no se cumple con esto se podrá producir una explosión, incendio o muerte.
- **Por motivos de seguridad personal, la secadora debe estar conectada a tierra adecuadamente.** Si no se cumple con esto se podrá producir una explosión, incendio o muerte.
- **Se debe enchufar esta secadora a un tomacorriente conectado a tierra de 120 VCA, 60 Hz protegido por un fusible o cortacircuitos de 15 amperios.** Si no se cumple con esto se podrá producir una explosión, incendio o muerte.
- **En caso de disponer de un tomacorriente de pared estándar de 2 patas, es su responsabilidad y obligación personales cambiarlo por uno de 3 patas conectado a tierra adecuadamente.** Si no se cumple con esto se podrá producir una explosión, incendio o muerte.

### ⚠️ ADVERTENCIA

#### PELIGRO DE DESCARGA ELÉCTRICA

Si no se observan las advertencias de seguridad, pueden producirse lesiones graves o la muerte.

Esta secadora está equipada con un enchufe de tres clavijas con conexión a tierra a fin de brindar protección contra descargas eléctricas y debe conectarse directamente a un receptáculo de tres terminales con una conexión a tierra adecuada. No corte ni quite la clavija de conexión a tierra de este enchufe.



## Conexión de secadoras a gas (cont.)

### ⚠️ ADVERTENCIA

Para reducir el riesgo de incendio, descargas eléctricas o heridas al usar su electrodoméstico, siga las precauciones básicas, incluyendo lo siguiente:

- **La instalación y el mantenimiento deben proveerse por un instalador calificado, agencia de mantenimiento o compañía de gas.** Si no se cumple con esto se podrá producir una explosión, incendio o muerte.
- **Use únicamente un conector de acero inoxidable nuevo y un conector certificado por AGA nuevo.** Si no se cumple con esto se podrá producir una explosión, incendio o muerte.
- **Se debe instalar una válvula de corte de gas a una distancia mínima de 6 pies (1,8 m) de la secadora.** Si no se cumple con esto se podrá producir una explosión, incendio o muerte.
- **La secadora está configurada para gas natural cuando se envía de fábrica. Asegúrese de que la secadora está equipada con la boquilla de quemador correcta para el tipo de gas que se usará (gas natural o petróleo líquido, LP).** Si no se cumple con esto se podrá producir una explosión, incendio o muerte.
- **Si es preciso, será un técnico cualificado quien instale la boquilla correcta (para el kit de conversión LP, con número de pieza 383EEL3002D) se deberá tomar nota de este cambio en la secadora.** Si no se cumple con esto se podrá producir una explosión, incendio o muerte.
- **Se deben realizar todas las conexiones según los códigos y las regulaciones locales.** Si no se cumple con esto se podrá producir una explosión, incendio o muerte.
- **Las secadoras de gas DEBEN ventilar hacia el exterior.** Si no se cumple con esto se podrá producir una explosión, incendio o muerte.

### Conexión del suministro de gas

1. Asegúrese de que el suministro de gas al cuarto de lavado se encuentre APAGADO. Confirme que el tipo de gas disponible en su cuarto de lavado sea el adecuado para la secadora. La secadora está lista para la conexión de gas natural de  $\frac{3}{8}$  pulgadas NPT.
2. Quite la tapa de envío de la conexión de gas localizada de la parte trasera de la secadora. Asegúrese de no dañar la rosca del conector de gas al quitar la tapa de envío.
3. Conecte la secadora al suministro de gas de su cuarto de lavado usando un conector de acero inoxidable flexible nuevo con una conexión de  $\frac{3}{8}$  pulgadas NPT.
4. Ajuste bien todas las conexiones entre la secadora y el suministro de gas de su cuarto de lavado. Abra el suministro de gas de su cuarto de lavado y verifique que no haya fugas en todas las conexiones de tubería (tanto interiores como exteriores) usando un fluido anticorrosivo para detección de fugas.

### Conexión eléctrica

Enchufe la secadora en un tomacorriente de **120 VCA, 60 Hz** de tres patas conectado a tierra.

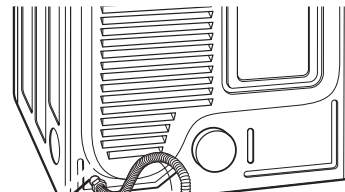
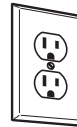

Conexión de gas  $\frac{3}{8}$ " NPT  
 Conector flexible de acero inoxidable certificado por AGA/CSA  
 Tapón de tubería de  $\frac{1}{8}$ " NPT  
 Válvula de corte de suministro de gas

### Instalaciones en lugares de gran altitud

La clasificación BTU para esta secadora es certificación AGA para elevaciones por debajo de los 10,000 pies.

Si va a instalar su secadora a más de 10,000 pies, debe ser desclasificada por un técnico calificado o compañía de gas.

## Cómo conectar las secadoras eléctricas

### ⚠️ ADVERTENCIA

Para ayudar a evitar incendios, descargas eléctricas, heridas graves o muerte, el cableado e instalación a tierra deben cumplir con la última edición del Código Eléctrico Nacional, ANSI/NFPA 70 y todas las regulaciones locales aplicables. Por favor comuníquese con un electricista calificado para que controle el cableado y los fusibles y así asegurar que su casa posea energía eléctrica adecuada para operar la secadora.

*Requisitos eléctricos únicamente para modelos eléctricos*

### ⚠️ ADVERTENCIA

Para reducir el riesgo de incendio, descargas eléctricas o heridas al usar su electrodoméstico, siga las precauciones básicas, incluyendo lo siguiente:

- **Esta secadora debe estar conectada a un sistema de cableado metálico permanente conectado a tierra, o se debe tender un conductor de conexión a tierra de equipo con los conductores de circuito y conectado a la terminal de conexión a tierra del equipo o conductor de la secadora.** Si no se cumple con esto se podrá producir una explosión, incendio o muerte.
- **La secadora tiene su propio bloque terminal, el cual debe conectarse a un circuito de una sola fase de 240 V CA, de 60 Hz, protegido con fusible de 30 amperios (el circuito debe tener protección de fusible a ambos terminales de la línea).** El suministro eléctrico de la secadora debiera ser de la máxima clasificación de voltage listada en la placa de características. **No conecte la secadora a un circuito de 110, 115 ó 120 voltios.** Si no se cumple con esto se podrá producir una explosión, incendio o muerte.
- **Si un circuito de ramal a la secadora es de 15 pies (4,5 m) o menos de longitud, use alambre listado por UL (Underwriters Laboratories) Núm.-10 AWG (únicamente alambre cobre), según lo requieran las leyes locales.** Si es más largo de 15 pies (4,5 m), use alambre listado por UL (Underwriters Laboratories) Núm.-8 AWG (únicamente alambre de cobre), o según lo requieran las leyes locales. **Disponga de suficiente dotación de cableado, de manera de poder mover la secadora de su ubicación normal cuando sea necesario.** Si no se cumple con esto se podrá producir una explosión, incendio o muerte.
- **NO se provee la conexión en espiral del cable eléctrico entre la caja de pared y el bloque terminal de la secadora con la misma.** El tipo de conexión en espiral y el calibre del alambre deben seguir los códigos locales y las instrucciones indicadas en las siguientes páginas. Si no se cumple con esto se podrá producir una explosión, incendio o muerte.
- **Se requiere una conexión de 4 hilos en todas las instalaciones de viviendas móviles y prefabricadas, así como en todas las construcciones nuevas posteriores al 1 de enero de 1996. Se debe usar una conexión de 4 hilos si los códigos locales no permiten la conexión a tierra utilizando el alambre neutro.** Si no se cumple con esto se podrá producir una explosión, incendio o muerte.

### ⚠️ ADVERTENCIA

Para reducir el riesgo de incendio, descargas eléctricas o heridas al usar su electrodoméstico, siga las precauciones básicas, incluyendo lo siguiente:

- **No modifique el enchufe ni el cableado interno facilitado con la secadora.**
- **La secadora deberá conectarse a una salida de 4 vías.**
- **Si no se adapta a la toma de corriente, deberá asegurarse de que un electricista calificado instale una adecuada.**

*Requisitos eléctricos especiales para viviendas móviles o prefabricadas*

### ⚠️ ADVERTENCIA

Para reducir el riesgo de incendio, descargas eléctricas o heridas al usar su electrodoméstico, siga las precauciones básicas, incluyendo lo siguiente:

- **Cualquier instalación en una vivienda móvil o prefabricada debe realizarse de conformidad con los Estándares de seguridad y construcción de viviendas prefabricadas, Título 24 CFR, Parte 3280 o estándar CAN/CSA Z240 MH y con los códigos y regulaciones locales.**
- **Se requiere una conexión de 4 hilos en todas las instalaciones de viviendas móviles y prefabricadas, así como en todas las construcciones nuevas posteriores al 1 de enero de 1996.** Si no se cumple con esto se podrá producir una explosión, incendio o muerte.

## Cómo conectar las secadoras eléctricas (cont.) SÓLO EE.UU.

### ⚠ ADVERTENCIA

• Conecte el cable de alimentación a la caja de terminales. Conecte cada uno de los conductores del cable de alimentación al tornillo de la caja de terminales que tenga el conductor del mismo color. Por ejemplo, conecte el conductor negro del cable de alimentación al tornillo de la caja de terminales que tiene el conductor negro. En caso de no seguir estas instrucciones, se podría producir un cortocircuito, una sobrecarga, incendio o muerte.

• Contacto por conductor neutro está prohibido para: (1) nuevas instalaciones de circuito derivado, (2) las casas móviles, (3) vehículos recreacionales, y (4) áreas donde los códigos prohíben una conexión a tierra por el conductor neutro.



**Conexión de cuatro hilos para secadoras eléctricas: Cable eléctrico con enchufe**

- Se requiere una conexión de 4 hilos en todas las instalaciones de viviendas móviles y prefabricadas, así como en todas las construcciones nuevas posteriores al 1 de enero de 1996.
  - Se requiere un protector de tensión listado por UL.
1. Quite la cubierta de acceso al bloque terminal localizado en la parte superior trasera de la secadora. Instale un protector de tensión listado por UL en el orificio de pase del cable eléctrico; luego pase un cable eléctrico conductor de cobre Núm. **10 AWG de por lo menos 4 hilos, 30 A, 240 V, listado por UL** por el protector de tensión.

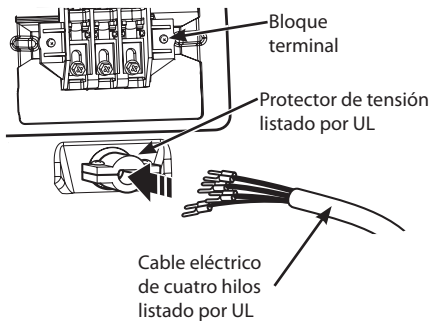

• Instale un cable eléctrico de **30 A, 240 V, listado por UL con un conductor de cobre Núm.-10 AWG** como mínimo y terminales de bucle cerrado o de horquilla con extremos doblados hacia arriba.

2. Transfiera el alambre de conexión a tierra de la secadora detrás del tornillo de conexión a tierra de color verde al tornillo central del bloque terminal. Conecte los dos conductores calientes del cable eléctrico a los tornillos del bloque terminal exterior. Conecte el cable neutro de color blanco al tornillo del bloque terminal central. Conecte el alambre de conexión a tierra del cable eléctrico al tornillo de conexión a tierra de color verde.

**AJUSTE BIEN TODOS LOS TORNILLOS.** Reinstale la cubierta de acceso del bloque terminal.

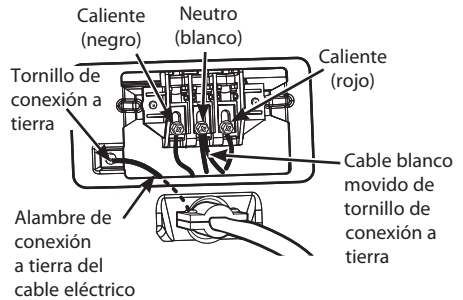

## Cómo conectar las secadoras eléctricas (cont.) SÓLO EE.UU.

### ⚠️ ADVERTENCIA

- Conecte el cable de alimentación a la caja de terminales. Conecte cada uno de los conductores del cable de alimentación al tornillo de la caja de terminales que tenga el conductor del mismo color. Por ejemplo, conecte el conductor negro del cable de alimentación al tornillo de la caja de terminales que tiene el conductor negro. En caso de no seguir estas instrucciones, se podría producir un cortocircuito, una sobrecarga, incendio o muerte.
- Contacto por conductor neutro está prohibido para: (1) nuevas instalaciones de circuito derivado, (2) las casas móviles, (3) vehículos recreacionales, y (4) áreas donde los códigos prohíben una conexión a tierra por el conductor neutro.

### Conexión de cuatro hilos para secadoras eléctricas: Conexión directa

- Se requiere una conexión de 4 hilos en todas las instalaciones de viviendas móviles y prefabricadas, así como en todas las construcciones nuevas posteriores al 1 de enero de 1996.
  - Se requiere un protector de tensión listado por UL.
1. Despegue 5 pulg. (12,7 cm) de la cubierta del cable del final. Descubra 5 pulg. de aislamiento del cable de conexión a tierra. Corte aproximadamente 1/2 pulg. (3,8 cm) de los otros 3 cables y despegue 1 pulg. (2,5 cm) del aislamiento del cada uno. Haga los finales de los 3 cables en forma de gancho.

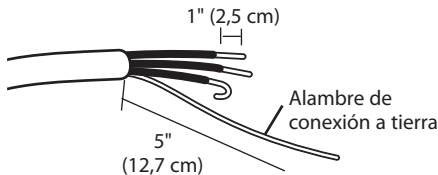

2. Quite la cubierta de acceso al bloque terminal localizado en la parte superior trasera de la secadora. Instale un protector de tensión listado por UL en el orificio de pase del cable eléctrico; luego pase el cable eléctrico fabricado en el Paso 1 por el protector de tensión.

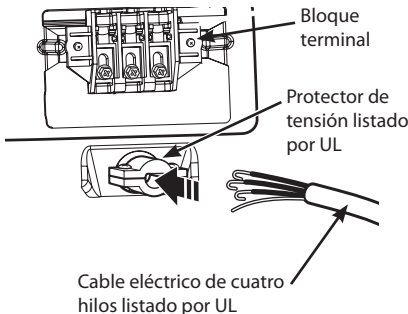

- Instale un cable eléctrico listado por UL con **4 conductores de cobre Núm.-10 AWG como mínimo.**
  - Prepare un mínimo de 5 pies (1,5 m) de longitud para poder quitar y reemplazar la secadora.
3. Transfiera el alambre de conexión a tierra de la secadora detrás del tornillo de conexión a tierra de color verde al tornillo central del bloque terminal. Conecte los dos conductores calientes del cable eléctrico a los tornillos del bloque terminal exterior. Conecte el cable neutro de color blanco al tornillo del bloque terminal central. Conecte el alambre de conexión a tierra del cable eléctrico al tornillo de conexión a tierra de color verde. **AJUSTE BIEN TODOS LOS TORNILLOS.** Reinstale la cubierta de acceso del bloque terminal.

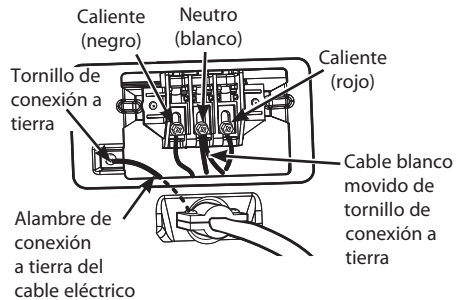

## Cómo conectar las secadoras eléctricas (cont.) SÓLO EE.UU.

### ⚠️ ADVERTENCIA

- Conecte el cable de alimentación a la caja de terminales. Conecte cada uno de los conductores del cable de alimentación al tornillo de la caja de terminales que tenga el conductor del mismo color. Por ejemplo, conecte el conductor negro del cable de alimentación al tornillo de la caja de terminales que tiene el conductor negro. En caso de no seguir estas instrucciones, se podría producir un cortocircuito, una sobrecarga, incendio o muerte.
- Contacto por conductor neutro está prohibido para: (1) nuevas instalaciones de circuito derivado, (2) las casas móviles, (3) vehículos recreacionales, y (4) áreas donde los códigos prohíben una conexión a tierra por el conductor neutro.



**Conexión de tres hilos para secadoras eléctricas: Cable eléctrico con enchufe**

- NO se permite una conexión de 3 hilos en construcciones nuevas después del 1 de enero de 1996.
  - Se requiere un protector de tensión listado por UL.
1. Quite la cubierta de acceso al bloque terminal localizado en la parte superior trasera de la secadora. Instale un protector de tensión listado por UL en el orificio de pase del cable eléctrico; luego pase un cable eléctrico conductor de cobre Núm. **10 AWG de por lo menos 3 hilos, 30 A, 240 V, listado por UL** por el protector de tensión.

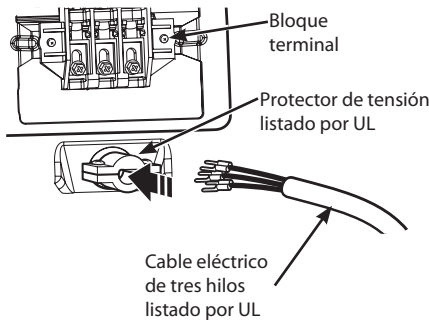

- Instale un cable eléctrico de **30 A, 240 V, listado por UL con un conductor de cobre Núm. 10 AWG como mínimo** y terminales de bucle cerrado o de horquilla con extremos doblados hacia arriba.
2. Conecte los dos conductores calientes del cable eléctrico a los tornillos del bloque terminal exterior. Conecte el cable neutro al tornillo del bloque terminal central. Conecte la conexión a tierra exterior (de ser requerido por los códigos locales) al tornillo de color verde. **AJUSTE BIEN TODOS LOS TORNILLOS.** Reinstale la cubierta de acceso del bloque terminal.

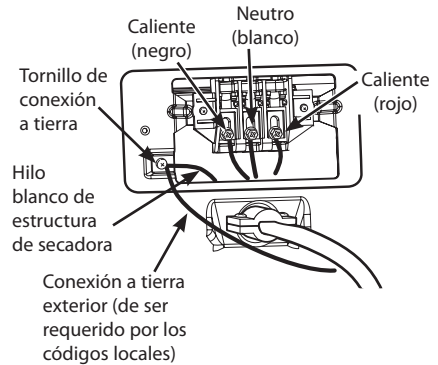

## Cómo conectar las secadoras eléctricas (cont.) SÓLO EE.UU.

### ⚠️ ADVERTENCIA

- Conecte el cable de alimentación a la caja de terminales. Conecte cada uno de los conductores del cable de alimentación al tornillo de la caja de terminales que tenga el conductor del mismo color. Por ejemplo, conecte el conductor negro del cable de alimentación al tornillo de la caja de terminales que tiene el conductor negro. En caso de no seguir estas instrucciones, se podría producir un cortocircuito, una sobrecarga, incendio o muerte.
- Contacto por conductor neutro está prohibido para: (1) nuevas instalaciones de circuito derivado, (2) las casas móviles, (3) vehículos recreacionales, y (4) áreas donde los códigos prohíben una conexión a tierra por el conductor neutro.

#### Conexión de tres hilos para secadoras eléctricas:

##### Conexión directa

- NO se permite una conexión de 3 hilos en construcciones nuevas después del 1 de enero de 1996.
  - Se requiere un protector de tensión listado por UL.
1. Despegue 3½ pulg. (8,9 cm) de la cubierta del cable del final. Despegue 1 pulg. (2,5 cm) del aislamiento decada alambre. Haga los finales de los 3 cables en forma de gancho.



2. Quite la cubierta de acceso al bloque terminal localizado en la parte superior trasera de la secadora. Instale un protector de tensión listado por UL en el orificio de pase del cable eléctrico; luego pase el cable eléctrico fabricado en el Paso 1 por el protector de tensión.

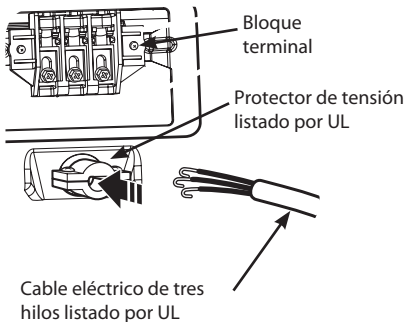

- Instale un cable eléctrico listado por UL con 3 conductores de cobre Núm.-10 AWG como mínimo.
  - Prepare un mínimo de 5 pies (1,5 m) de longitud para poder quitar y reemplazar la secadora.
3. Conecte los dos conductores calientes del cable eléctrico a los tornillos del bloque terminal exterior. Conecte el cable neutro al tornillo del bloque terminal central. Conecte la conexión a tierra exterior (de ser requerido por los códigos locales) al tornillo de color verde. **AJUSTE BIEN TODOS LOS TORNILLOS.** Reinstale la cubierta de acceso del bloque terminal.

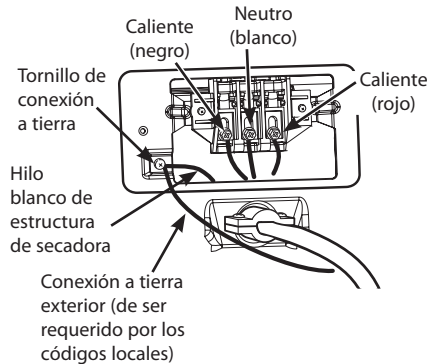

## Requisitos especiales para viviendas móviles o prefabricadas

Cualquier instalación en una vivienda móvil o prefabricada debe realizarse de conformidad con los Estándares de seguridad y construcción de viviendas prefabricadas, Título 24 CFR, Parte 3280 o estándar CAN/CSA Z240 MH y con los códigos y regulaciones locales. Si no está seguro de si la instalación que ha propuesto cumple con estos estándares, llame a un técnico de mantenimiento e instalación para obtener ayuda.

- Una secadora de gas debería fijarse permanentemente sobre el piso.
- La conexión eléctrica de una secadora eléctrica debe ser una conexión de 4 hilos. Se provee información más detallada pertinente a la conexión eléctrica en la sección Cómo conectar las secadoras eléctricas.
- Para reducir el riesgo de combustión e incendio, se debe ventilar la secadora hacia el exterior.
- NO ventile la secadora debajo de una vivienda móvil o prefabricada.
- Las secadoras eléctricas deben ventilarse hacia el exterior usando el panel trasero, izquierdo, derecho o inferior.
- Las secadoras a gas deben ventilarse al exterior usando el panel trasero, izquierdo o inferior. Las secadoras a gas no deben ventilarse hacia el exterior usando el panel derecho debido a la carcasa del quemador.
- El conducto de escape de la secadora debe estar bien fijado a la estructura de la vivienda móvil o prefabricada, y el conducto de escape debe estar fabricado de un material resistente al fuego y la combustión. Se recomienda el uso de un conducto de metal rígido o flexible.
- NO conecte el conducto de escape de la secadora a ningún otro conducto, respiradero, chimenea ni a ningún otro tipo de conducto de escape.
- Asegúrese de que la secadora disponga de acceso adecuado al aire fresco del exterior para garantizar un funcionamiento adecuado. La abertura para la toma de aire fresco exterior debe ser de por lo menos 25 pulgadas<sup>2</sup> (163 cm<sup>2</sup>).
- Es importante que el espacio libre del conducto con respecto a cualquier material combustible de construcción sea de por lo menos 2 pulgadas (5 cm) y que, cuando se ventile la secadora al exterior, se pueda instalar la secadora dejando un espacio libre de 1 pulgada (2,5 cm) a los lados y la parte trasera de la secadora.
- Tenga en cuenta que los materiales de ventilación no se proveen con la secadora. Debe obtener los materiales de ventilación necesarios para una instalación adecuada.

## Revisión de instalación final

Una vez que haya completado la instalación de la secadora y la misma se encuentre en su ubicación final, confirme que funcione correctamente realizando las siguientes pruebas.

### Comprobación del calentamiento de la secadora

#### MODELOS A GAS

Cierre la puerta de la secadora, apriete el interruptor ON/OFF para encender la secadora, e iniciar la secadora en un ajuste de calor. Cuando inicia la secadora, el encendedor deberá encender el quemador principal.

#### ! NOTA

Si no se purga todo el aire de la línea de gas, el encendedor de gas podría apagarse antes de que se encienda el quemador. Si esto sucede, el encendedor volverá a intentar encender el gas después de aproximadamente dos minutos.

#### MODELOS ELÉCTRICOS

Cierre la puerta de la secadora, apriete el interruptor ON/OFF para encender la secadora, e iniciar la secadora en un ajuste de calor. El escape de aire deberá estar caliente después de que la secadora haya funcionado durante 3 minutos.

#### Revisión del flujo de aire

El funcionamiento efectivo de la secadora requiere de un flujo de aire adecuado. La corrección del flujo de aire puede medirse evaluando la presión estática. La presión estática del conducto del escape se puede medir con un manómetro, colocado en el conducto de escape aproximadamente a 2 pies (60,9 cm) de distancia de la secadora. La presión estática del conducto de escape no debería exceder las 0,6 pulgadas (1,5 cm). Se debe revisar la secadora mientras está funcionando sin carga.

#### Revisión del nivelado

Una vez que la secadora se encuentra en su ubicación final, vuelva a revisar que la misma se encuentre nivelada. Asegúrese de que esté nivelada de adelante hacia atrás y de lado a lado, y de que las cuatro patas niveladoras se encuentren asentadas en el piso firmemente.

## Prueba de Instalación (Comprobación del sistema de evacuación)

Una vez haya instalado la secadora, haga este prueba para asegurarse de que las condiciones del sistema de evacuación son las adecuadas para el funcionamiento correcto de la secadora. Este prueba tiene como objetivo mostrarle si existe algún problema importante en el sistema de evacuación de su vivienda.

- Esta secadora cuenta con el sistema FLOW SENSE™, un sistema innovador que detecta automáticamente los bloqueos y restricciones en la tubería de la secadora. Mantener la tubería sin acumulación de pelusa y libre de restricciones le permitirá secar la ropa más rápido y reducir el gasto de energía.

### NOTA

La secadora deberá estar fría antes de iniciar el prueba. Si la unidad se ha calentado durante la instalación, active el sistema SECADO CON AIRE (AIR DRY) durante unos minutos para reducir la temperatura interior.

### Activar el prueba de instalación:

- 1. Retire la rejilla de secado y la documentación, y cierre la puerta.** No meta nada en el tambor cuando se disponga a hacer este prueba porque podría influir en la precisión de los resultados.

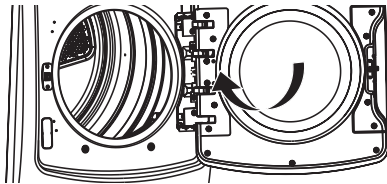

- 2. Pulse mantenga pulsados el botón Encendido(Power), y luego pulse y mantenga pulsado Temp.(Temp.) y Spitido(Signal) más de 0,5 segundos**

Esta secuencia de botones activa el test de instalación. El código **in5** aparecerá en la pantalla de visualización si la activación se ha realizado con éxito.



- 3. Mantenga presionado el botón INICIO/PAUSA(START/PAUSE).**

La secadora iniciará el prueba, que durará alrededor de dos minutos. Se encenderá el calor y se medirán las temperaturas en el tambor.



- 4. Observe la pantalla para conocer el resultado.**

Durante el ciclo de prueba, observe la pantalla de Flow Sense™ en el panel de control. Si el texto del indicador de Flow Sense se ilumina, el sistema de escape está restringido. Si el texto del indicador permanece apagado, la operación del sistema de escape es adecuada. Si existen otros problemas, estos se le indicarán con códigos de error. Consulte en la página siguiente el listado de códigos de error y sus soluciones.



APAGADO:  
CORRECTO



ILUMINADO  
RESTRICCIÓN

Revise el sistema de inmediato, ya que de no hacerlo el funcionamiento será muy deficiente.

- 5. Fin del ciclo.**

Al finalizar el prueba aparecerá **End** en la pantalla de visualización. Una vez haya terminado este ciclo, la secadora se apagará automáticamente después de unos momentos.





## Prueba de instalación (Conducto de comprobar) (cont.)

- Compruebe el código de error antes de llamar al servicio técnico

Código de error	Causas posibles	Soluciones
<b>tE1 o tE2</b>	• Fallo del sensor de temperatura.	• Apague la secadora y llame al servicio técnico.
<b>HS</b>	• Fallo del sensor de humedad.	• Apague la secadora y llame al servicio técnico.
<b>PS o PF o nP</b>	<ul style="list-style-type: none"> <li>• El cable de alimentación no está conectado correctamente o el suministro eléctrico de la vivienda es incorrecto.</li> <li>• Se han fundido los fusibles, ha saltado el disyuntor o ha habido un apagón.</li> </ul>	<ul style="list-style-type: none"> <li>• Compruebe el suministro eléctrico o la conexión del cable de alimentación al enchufe. Consulte la sección "Cómo conectar las secadoras eléctricas" de este manual para las instrucciones completas.</li> <li>• Reactive el disyuntor o reemplace el fusible. No incremente la capacidad del fusible. Si el problema es una sobrecarga del circuito, solicite los servicios de un electricista calificado.</li> </ul>

### • Compruebe las condiciones del conducto

Si el LED de FLOW SENSE se enciende, compruebe que no haya restricciones o daños en el sistema de vaciado. Repare o reemplace el sistema de evacuación según sea necesario.

#### ! NOTA

Cuando recién se instala la secadora, debe realizarse esta prueba para alertarlo sobre cualquier clase de problemas con el conducto de extracción de su hogar. Sin embargo, puesto que la prueba realizada durante un funcionamiento normal ofrece una información más precisa sobre el estado del conducto de extracción que la prueba de instalación, la cantidad de barras visualizadas durante las dos pruebas puede no ser la misma.

No interrumpa la prueba, ya que de caso contrario podría obtener resultados erróneos.

Aunque no se ilumine ninguna barra tras el ciclo de prueba, es posible que existan algunas restricciones en el sistema de evacuación. Consulte la sección "Instalación del conducto de ventilación" en este manual para conocer todos los requisitos del sistema de evacuación y de ventilación.

Esta secadora cuenta con el sistema Flow Sense™, un sistema innovador que detecta automáticamente los bloqueos y restricciones en la tubería de la secadora. Mantener la tubería sin acumulación de pelusa y libre de restricciones le permitirá secar la ropa más rápido y reducir el gasto de energía.

### Flujo de Aire Restringido o Bloqueado

Evite funcionamientos prolongados o funcionamientos con múltiples formaciones de torceduras o codos.

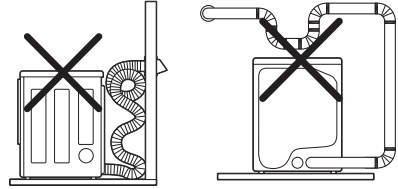

Conducto demasiado largo o muy torcido

Tubería demasiado larga o con demasiados codos

Controle los bloqueos y la acumulación de pelusa.

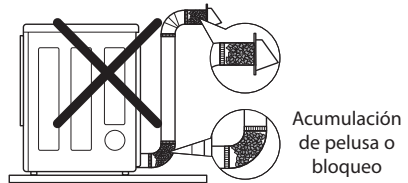

Acumulación de pelusa o bloqueo

Asegúrese que la tubería no posea cortes ni restricciones.

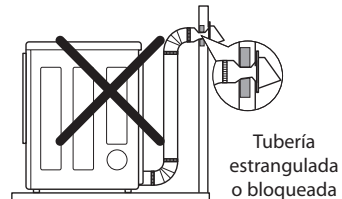

Tubería estrangulada o bloqueada

# CÓMO USAR

## Funcionamiento de la secadora

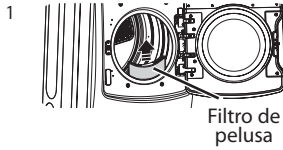

### LIMPIAR EL FILTRO DE PELUSAS

Si aún no ha limpiado el filtro de pelusas, extráigalo y elimine las pelusas procedentes de la última carga. Esto le ayudará a asegurar un funcionamiento más rápido y eficiente de secado.

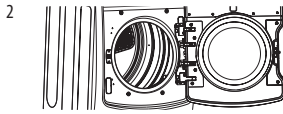

### CARGAR LA SECADORA

Cargue en la secadora la carga húmeda procedente de la lavadora. Si la carga es muy grande, deberá dividirla en cargas más pequeñas para obtener un buen rendimiento y proteger los tejidos.



### ENCENDER LA SECADORA

Presione los botones selectores de ciclos repetidamente hasta seleccionar el ciclo deseado. Si se enciende, los LEDs de ciclo se iluminarán y se emitirá un aviso sonoro. Consulte la página 12.

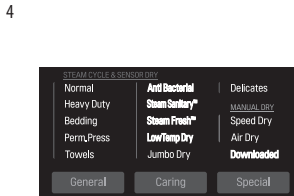

### SELECCIONAR UN CICLO

Gire el mando del selector de ciclo en cualquier sentido hasta que se ilumine el LED del ciclo que desee. Se mostrarán los ajustes preestablecidos de temperatura, nivel de secado y opción para este ciclo. Consulte la página 34. Los ajustes predeterminados para el ciclo seleccionado podrán cambiarse ahora si lo desea. Esto puede llevarse a cabo utilizando los botones modificadores de ciclo tal y como se muestra en la página 37. Las opciones de ciclo pueden añadirse utilizando los botones de opción tal y como se muestra en la página 37-40.

### ! NOTA

No todas las opciones ni modificadores están disponibles para todos los ciclos. Se escuchará un sonido diferente y la luz LED no se iluminará si la selección no está permitida.



### INICIAR EL CICLO

Mantenga presionado el botón INICIO/PAUSA (START/PAUSE) para iniciar el ciclo. El ciclo puede ser pausado en cualquier momento abriendo la puerta o presionando el botón INICIO/PAUSA (START/PAUSE). Si no vuelve a iniciarse el ciclo tras 4 minutos, la secadora se apagará y los ajustes del ciclo se perderán.



### FIN DEL CICLO

Al finalizar el ciclo, si lo tiene ajustado, oír un aviso sonoro. Retire inmediatamente sus prendas de la secadora para reducir las arrugas. Si tiene seleccionada la función CUIDADO DE ARRUGAS (WRINKLE CARE), la secadora voltará brevemente la carga cada pocos minutos para ayudar a prevenir la aparición de arrugas en sus prendas.

## Guía de ciclos

■ = configuración por defecto  
○ = opción permisible de

Ciclo	Tipo de tela	Nivel de secado	Temperatura	Tiempo	Más tiempo/ Menos tiempo	Cuidado de arrugas	Turbo Steam	Sonido de secado húmedo	El ahorro de energía
Steam Fresh™	Acolchados, camisas, pantalones (excepto prendas muy delicadas)	Apagado	Media	10	○	○	○		
			Alta						
			Regulable	Regulable					
Steam Sanitary™	Acolchados, ropa de cama, ropa de niños.	Apagado	Alta	31		○	○		
Anti Bacterial	No utilizar este ciclo con prendas delicadas.	Muy	Alta	1:10		○			
Secado a BajaTemp (LowTemp Dry)	Sólo prendas normales y/tipo toallas (máx. aprox. 1,5 kg)	Normal	Alta	50		○			
		Regulable							
Ropa de cama (Bedding)	Acolchados, almohadas, camisas.	Normal	Media	55					
		Regulable							
Secado Intenso (Heavy Duty)	Vaqueros, prendas pesadas.	Normal	Alta	54		○	○	○	
		Regulable							
Normal (Normal)	Ropa de trabajo, pana, etc.	Normal	Media	41		○	○	○	○
		Regulable							
Jumbo Dry (Secado Jumbo)	Acolchados, almohadas, camisas.	Normal	Media	1:25		○			
		Regulable							
Planchado Perm. (Perm. Press)	Prendas sintéticas, planchado permanente.	Normal	Baja	32		○	○	○	
		Regulable							
Delicado (Delicates)	Lencería, sábanas, blusas	Normal	Baja	28		○		○	
		Regulable							
Toallas (Towels)	Prendas vaqueras, toallas, algodón resistente.	Normal	Media Alta	55		○		○	
		Regulable							
Secado Rápido (Speed Dry)	Para poca carga con tiempos de secado cortos.	Apagado	Alta	25	○	○			
			Regulable						
Secado Por Aire (Air Dry)	Para prendas que no precisan calor, por llevar plástico o goma	Apagado	Apagado	30	○	○			
			Regulable						

**Ciclos de SECADO CON SENSOR (SENSOR DRY)**

Los ciclos de SECADO CON SENSOR utilizan el sistema exclusivo de sensor doble de LG para detectar y comparar el nivel de humedad en las prendas y en el aire, y programar el tiempo de secado del modo necesario para asegurar resultados superiores. La secadora ajusta automáticamente el nivel de sequedad y temperatura del ajuste recomendado para cada ciclo. El tiempo restante estimado se mostrará en la pantalla.

**LowTemp Dry (secado a baja temp.)**

Este ciclo puede ahorrar mas energía que el ciclo Normal, dependiendo del tamaño de la carga. Puede ser necesario ajustar el Nivel de Secado para lograr el nivel de secado deseado.

**! NOTA**

Para proteger sus prendas, no todos los niveles, temperatura u opciones están disponible con cada ciclo. Consulte la guía de ciclos para los detalles.

**Ciclos de SECADO MANUAL (MANUAL DRY)**

Use los ciclos de SECADO MANUAL para seleccionar una cantidad específica de tiempo y temperatura de secado. Cuando se selecciona el ciclo de SECADO MANUAL, la pantalla de TIEMPO RESTANTE ESTIMADO (ESTIMATED TIME REMAINING) muestra el tiempo restante real en su ciclo. Puede cambiar el tiempo real en el ciclo apretando MÁS TIEMPO (MORE TIME) o MENOS TIEMPO (LESS TIME).

**NSF CERTIFICADO POR NSF/P154**

NSF International (anteriormente, National Sanitation Foundation, Fundación Nacional de Saneamiento), certifica que el ciclo de desinfección **Anti Bacterial** reduce el 99,9% de las bacterias presentes en la colada y que no se transmitirá ninguna bacteria a la siguiente carga.











- Los ajustes predeterminados para el ciclo **Anti Bacterial** son temperatura **Alta** y secado **Muy Seco**. Estos ajustes predeterminados no se pueden cambiar.
- NO utilice este ciclo para prendas o tejidos delicados.

## Clasificación de cargas

### Etiquetas de mantenimiento de las telas

La mayoría de las prendas de vestir tienen etiquetas de mantenimiento de las telas para lograr un mantenimiento adecuado.

**Etiquetas de cuidado de las telas**

Secado a máquina			
	Seco	Normal	Planchado permanente/ antiarrugas
			
	Suave/ delicado	No secar a máquina	No secar (utilizado junto a "no lavar")
Ajuste de calor			
	Alto	Mediano	Bajo
			
			Sin calor/ai

### Agrupamiento de prendas similares

Para obtener los mejores resultados, clasifique las prendas en cargas que puedan secarse con el mismo ciclo de secado.

Los diferentes tipos de telas tienen diferentes requisitos de cuidado, y algunas telas se secarán más rápido que otras.

## Cómo cargar la secadora

### ⚠️ ADVERTENCIA

Para reducir el riesgo de incendio, descargas eléctricas o heridas al usar su electrodoméstico, siga las precauciones básicas, incluyendo lo siguiente:

- **Revise todos los bolsillos para asegurarse de que estén vacíos. Los artículos como clips, fósforos, plumas, monedas y llaves pueden dañar su secadora o sus prendas. Los objetos inflamables tales como encendedores o fósforos podrían encenderse y provocar un incendio.** Si no se cumple con esto se podrá producir una explosión, incendio o muerte.
- **Nunca seque prendas que hayan sido expuestas a aceite, gasolina u otras sustancias inflamables. Lavar las prendas no eliminará completamente los residuos de aceite.** Si no se cumple con esto se podrá producir una explosión, incendio o muerte.

### ! NOTA

#### Consejos útiles de carga

- Combine prendas grandes y pequeñas en una carga.
- Las prendas húmedas se extenderán mientras se secan. No sobrecargue la secadora; las prendas necesitan de espacio para girar y secar adecuadamente.
- Cierre las cremalleras, ganchos y cordones para prevenir que estos artículos se enganchen o enreden en otras prendas.

## Revise el filtro de pelusa antes de cada uso

Asegúrese siempre de que el filtro de pelusa esté limpio antes de iniciar una carga nueva; un filtro de pelusa bloqueado incrementará los tiempos de secado.

Para limpiarlo, tire del filtro de pelusa verticalmente y, con los dedos, enrolle cualquier pelusa para retirarla del filtro. No enjuague ni lave el filtro para eliminar la pelusa. Empuje el filtro de pelusa firmemente en su lugar. Para información adicional, vea la sección LIMPIEZA REGULAR.

Asegúrese siempre de que el filtro de pelusa esté instalado adecuadamente antes de poner en funcionamiento la secadora. Hacer funcionar la secadora sin el filtro o con un filtro de pelusa suelto podría dañar la secadora y los artículos en el interior de la misma.

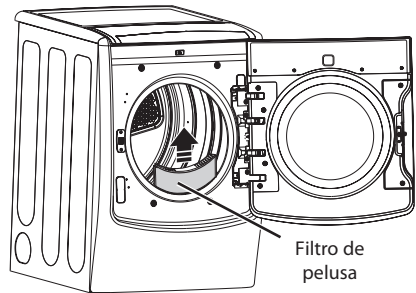

## Almacenamiento bajo la Tapa

- Bajo la tapa hay tres pequeños espacios de almacenamiento.
- Para abrir la tapa, deslicela hacia atrás.

### ⚠️ ADVERTENCIA

No almacene sustancias inflamables ni adhesivos bajo la tapa.

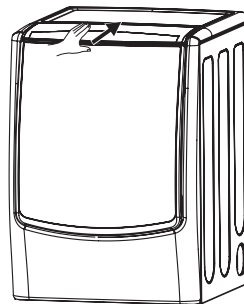

## Uso de la Tapa

### Apertura de la tapa

- Empuje la manija frontal para deslizar y abrir la tapa.

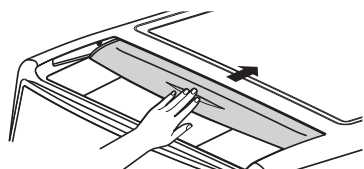

### Cierre de la tapa

- Tire de la parte superior de la manija para deslizar y cerrar la tapa.

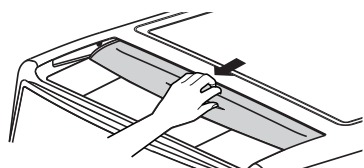

### ⚠ ADVERTENCIA

• Para evitar lesiones, no ponga los dedos debajo de la tapa ni entre la tapa y la placa superior cuando haga presión sobre la tapa superior o la deslice para abrirla o cerrarla.

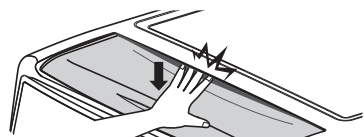
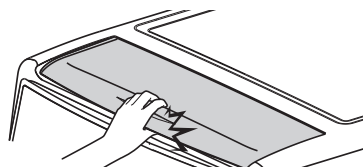
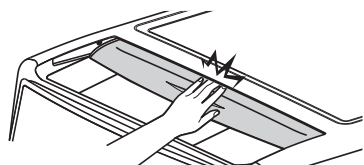

## Botones modificadores de ciclo

Los ciclos de SECADO CON SENSOR (SENSOR DRY) tienen ajustes preprogramados que se seleccionan automáticamente. Los ciclos de SECADO MANUAL (MANUAL DRY) tienen ajustes predeterminados, pero pueden Personalizarse usando los botones de ajustes de ciclos. Apriete el botón de esa opción para ver y seleccionar otros ajustes.

### ! NOTA

Para proteger las prendas, no todos los niveles de secado, temperatura u opción están disponibles en todos los ciclos. Vea la Guía de ciclos para obtener más detalles.

### NIVEL DE SECADO (DRY LEVEL)

Selecciona el nivel de sequedad para el ciclo. Apriete el botón de NIVEL DE SECADO (DRY LEVEL) varias veces para navegar por los ajustes disponibles.

- Esta opción está disponible únicamente en los ciclos de SECADO CON SENSOR (SENSOR DRY).
- La secadora ajustará el tiempo de ciclo automáticamente. Al seleccionar MÁS (MORE) o MUY (VERY) se incrementará el tiempo del ciclo, mientras que HUMEDO (DAMP) o MENOS (LESS) disminuirá el tiempo del ciclo.
- Use un ajuste HUMEDO (DAMP) o MENOS (LESS) en los artículos que desee planchar.

### TEMPERATURA (TEMP.)

Regula el ajuste de temperatura desde ULTRA BAJO (ULTRA LOW) a ALTO (HIGH). Esto permite el cuidado preciso de sus telas y prendas. Apriete el botón TEMPERATURA (TEMP.) varias veces para navegar por los ajustes disponibles.

### SECADO DE TIEMPO (TIME DRY)

Le permite seleccionar el tiempo de secado manualmente, de 20 a 60 minutos, en incrementos de 10 minutos. Use esta opción en cargas pequeñas o para eliminar arrugas. Use los botones de MÁS TIEMPO/ MENOS TIEMPO (MORE TIME/LESS TIME) para añadir o reducir el tiempo de secado en incrementos de 1 minuto.

Su secadora dispone de varias opciones de ciclo adicionales, las cuales personalizan los ciclos para satisfacer sus necesidades individuales. Ciertos botones de opción también incorporan una función especial (vea la siguiente página para obtener mayor información) que puede activarse apretando y manteniendo apretado ese botón de opción por 3 segundos.

### Para añadir opciones de ciclo a un ciclo:

1. Encienda la secadora y presione los botones selectores de ciclos repetidamente para seleccionar el ciclo deseado.
2. Use los botones de programación de ciclo para fijar los ajustes para ese ciclo.
3. Apriete el(los) botón(es) de opción de ciclo para la opción que desea añadir. Aparecerá en la pantalla un mensaje de confirmación.
4. Mantenga presionado el botón INICIO/PAUSA (START/PAUSE) para iniciar el ciclo. La secadora iniciará automáticamente.

### SEÑAL (SIGNAL)

Ajusta el volumen o apaga los sonidos de los botones o la melodía de ciclo finalizado. Presione repetidamente el botón hasta que se ilumine el volumen deseado.

## Funciones especiales

Los botones de opción también activan las funciones especiales, incluyendo, SEGURO A PRUEBA DE NIÑOS (CHILD LOCK). Seleccione la opción deseada presionando el botón. Al pulsar y mantener presionado el botón se activarán las características especiales marcadas con el asterisco (\*), tales como Seguro a prueba de niños.

### \* CERRADURA A PRUEBA DE NIÑOS (CHILD LOCK)

Utilice esta opción para evitar usos indeseados de la secadora o para evitar modificaciones en las configuraciones de ciclo mientras la secadora esta funcionando. Presione y sostenga el botón de durante 3 segundos para activar o desactivar la función SEGURO A PRUEBA DE NIÑOS (CHILD LOCK).

Cuando se ha fijado el seguro infantil, aparecerá el indicador de seguro infantil en la pantalla y se desactivarán todos los botones excepto el botón de ENCENDIDO/APAGADO (POWER).

### ! NOTA

Una vez seleccionado, el SEGURO A PRUEBA DE NIÑOS permanece activo hasta que se desactiva manualmente. El SEGURO A PRUEBA DE NIÑOS debe estar desactivado para ejecutar otro ciclo. Para desactivar el SEGURO A PRUEBA DE NIÑOS, mantenga pulsado el botón por tres segundos.

### SEÑAL DE SECADO HÚMEDO (DAMP DRY SIGNAL)

Con esta opción, la secadora hará sonar una alarma cuando la carga está 80% seca. Esta función le permite retirar el(los) artículo(s) liviano(s) que seca(n) rápidamente o que desea planchar o colgar mientras aún se encuentran húmedos. Presione el botón SEÑAL DE SECADO HÚMEDO (DAMP DRY SIGNAL).

### CUIDADO DE ARRUGAS (WRINKLE CARE)

Al seleccionar esta opción, hará girar la carga periódicamente por un plazo de hasta 3 horas después del ciclo seleccionado, o hasta que se abra la puerta. Esto es de ayuda para prevenir la formación de arrugas cuando no le sea posible retirar las prendas de la secadora inmediatamente.

### DE AHORRO DE ENERGÍA (ENERGY SAVER)

Esta opción le permite reducir el consumo de energía en el ciclo Normal, dependiendo del tamaño de la carga.

Cuando se seleccione el ahorro de energía, el ciclo comienza con una sección de secado por aire y se aumenta el tiempo de secado .

### RED INTELIGENTE

Reduzca los costos energéticos al secar las prendas de ropa evitando los tiempos de uso pico. Refiérase a la sección Conectividad inteligente para obtener más información.

### \*INICIO REMOTO

Use un teléfono inteligente para controlar la secadora en forma remota. Refiérase a la sección Conectividad inteligente para obtener más información.

## Programa personalizado

Si tiene una combinación especial de ajustes que usa con frecuencia, puede guardar estos ajustes a manera de PROGRAMA PERSONALIZADO (CUSTOM PROGRAM).

### Para guardar un programa personalizado:

1. Encienda la secadora y presione los botones selectores repetidamente para seleccionar el ciclo deseado.
2. Use los botones de programación de ciclo para fijar los ajustes para ese ciclo.
3. Presione el(los) botón(es) de opción de ciclo para la opción que desea añadir. Aparecerá en la pantalla un mensaje de confirmación.
4. Pulse y mantenga presionado el botón PROGRAMA PERSONALIZADO (PGM Save) por tres segundos.

### ! NOTA

Puede guardar sólo un programa personalizado a la vez. Al pulsar y mantener presionado el botón PROGRAMA PERSONALIZADO (PGM Save), reemplazará cualquier programa personalizado que haya guardado anteriormente.

### Para recuperar un programa personalizado:

1. Encienda la secadora.
2. Presione el botón PROGRAMA PERSONALIZADO (CUSTOM PGM).
3. Mantenga presionado el botón INICIO/PAUSA (START/PAUSE) para iniciar el ciclo.

## Funciones de vapor

La nueva tecnología de vapor de LG le permite inyectar las telas con un chorro giratorio de vapor caliente para refrescar las prendas. Simplemente seleccione el ciclo STEAM FRESH™ o agregue la opción Vapor (Steam) a los ciclos seleccionados.

### Cómo usar el ciclo STEAM FRESH™

STEAM FRESH™ utiliza sólo el poder del vapor para rápidamente reducir arrugas y olores de las telas. Da nueva vida a las prendas arrugadas que han estado guardadas por mucho tiempo y facilita el planchado en ropa muy arrugada. STEAM FRESH™ también puede usarse para reducir los olores en las telas.

### ! NOTA

- Dependiendo de la carga (cantidad de prendas), puede modificarse el tiempo del ciclo presionando los botones MÁS TIEMPO (MORE TIME) o MENOS TIEMPO (LESS TIME). En la pantalla podrá verse 1, 3, 5, o  $\frac{b}{i}$   $\frac{9}{9}$ . 3 significa 3 o menos prendas, 5 es para 4 ó 5 prendas, y  $\frac{b}{i}$   $\frac{9}{9}$  indica una carga grande, como un edredón.

### Para usar el ciclo STEAM FRESH™:

1. Encienda la secadora y presione los botones selectores de ciclos repetidamente para seleccionar el ciclo STEAM FRESH™.
2. Para agregar una función opcional, seleccione TURBOSTEAM o CUIDADO DE ARRUGAS (WRINKLE CARE).
3. Dependiendo de la carga (cantidad de prendas), puede modificarse el tiempo de vapor presionando los botones MÁS TIEMPO (MORE TIME) o MENOS TIEMPO (LESS TIME)
4. Mantenga presionado el botón de INICIO/PAUSA (START/PAUSE) para iniciar el ciclo.

### Para agregar VAPOR (STEAM) a un ciclo estándar:

1. Encienda la secadora y presione los botones selectores de ciclos repetidamente para seleccionar el ciclo Normal, Planchado Perm., o Secado Intenso.
2. Utilice los botones de configuración de ciclo para ajustar las configuraciones para ese ciclo.
3. Presione el botón turbo Steam.
4. Mantenga presionado el botón de INICIO/PAUSA (START/PAUSE) para iniciar el ciclo.

### Cómo usar el ciclo STEAM SANITARY™

El nuevo ciclo STEAM SANITARY™ es idóneo para la higienización rápida y sencilla de elementos que no pueden lavarse, utilizando sólo el poder del vapor. Recomendamos utilizar este ciclo para tejidos de algodón y poliéster. (NO use para espuma de uretano, plumas o prendas delicadas).



## Funciones de vapor (cont.)

### ⚠ WARNING

- **No abra la puerta de la secadora durante ciclos de vapor.** Si no se cumple con esto se podrá producir una explosión, incendio, quemaduras o muerte.
- **No toque la boquilla de vapor del tambor durante o después del ciclo de vapor.** Si no se cumple con esta advertencia se podrán producir heridas graves o muerte.

### ! NOTA

- Puede que el vapor no sea claramente visible durante los ciclos de vapor. Esto es normal.
- No use el ciclo STEAM FRESH™ con elementos como lana, manta de lana, camperas de cuero, seda, ropa húmeda, lencería, productos de espuma o mantas eléctricas.
- Para mejores resultados, las prendas deben ser de tamaños y de tipos de tela similares. No sobrecargue la secadora.
- Cuando se tapa el filtro/conducto, la opción vapor (steam) puede no tener resultados óptimos.
- Cuando la función vapor (steam) está siendo utilizada, el tambor se detendrá para permitir que el vapor permanezca en el tambor.

## Guía de ciclo de vapor

	Vapor	Tiempo programado por la fábrica	Control temp.	Nivel de Secado	Estado de tela	Tipo de tela	Cantidad Máx.
Steam Sanitary™		31 Min.			Seca	Camisas, Ropa de cama	Camisas (1 cada)
			Ropa de niños	3 lbs.			
Steam Fresh™		10 Min.	○		Seca	Edredón	Camisas (1 cada)
			Camisas*	5 cada			
Opción de Vapor	+ Turbo Steam	Siga el ciclo Seleccionado		○	Mojada	Varía según el ciclo seleccionado	8 lbs. (18 ARTICULOS)

\* Camisa: mezcla de 70% algodón:30% poliéster. Excepto telas especialmente delicadas

- Cuando se tapan el filtro de pelusas o el conducto de salida, las opciones de vapor no darán los resultados adecuados.
- Para mejores resultados, las prendas deben ser de tamaños y de tipos de tela similares. No sobrecargue la secadora.

# CONECTIVIDAD DEL ELECTRODOMÉSTICO INTELIGENTE

## Información general de conectividad

Su electrodoméstico ahora hace algo más que solo lavar la ropa. Una vez conectado a Internet a través de la red Wi-Fi de su hogar, puede comprobar el avance de un ciclo y controlar el aparato en forma remota con la aplicación Smart Laundry de LG para su teléfono inteligente.

La aplicación puede configurarse para enviar notificaciones automáticas cuando el ciclo ha finalizado o cuando el aparato tiene problemas. También proporciona una lista de ciclos adicionales disponibles para su descarga, y ayuda a solucionar problemas mediante el registro y el análisis de datos del aparato. El aparato tiene la capacidad Smart Grid para las áreas donde la compañía eléctrica ha instalado equipos Smart Grid. Esta función ajusta los tiempos de funcionamiento del aparato cuando los precios de la electricidad son más bajos o retrasa el funcionamiento cuando la demanda de electricidad es alta.

## Configuración de la conectividad

### Instale la aplicación LG Smart Laundry

1. Ejecute Google Play Store en su teléfono inteligente con Android.
2. Busque LG Smart Laundry.
3. Pulse LG Smart Laundry en la lista de resultados.
4. Presione el INSTALAR y ACEPTAR para instalar automáticamente la aplicación. También puede comprobar el avance a través del teléfono inteligente.
5. Cuando la instalación esté completa, toque el ícono de acceso a la aplicación.

• Más adelante admitirá la aplicación LG Smart Laundry para dispositivos iOS.

### Configuración del perfil (configuración de ID y contraseña)

Puede omitir los siguientes pasos si ya tiene una cuenta LG en <http://us.smartthinQ.com>

1. Ejecute la aplicación LG Smart Laundry en su teléfono inteligente.
2. Seleccione el Login (inicio de sesión) en la pantalla.
3. Seleccione el botón *Create an account* (crear una cuenta) en la parte inferior de la pantalla.
4. En la siguiente pantalla, debe aceptar los términos y condiciones, la política de privacidad y los términos y condiciones de la cuenta de LG. Después de seleccionar *I agree* (acepto), pulse el botón Confirm (confirmar).
5. A continuación, en el buzón del correo electrónico, introduzca su dirección de correo electrónico. Esta será su ID de usuario. Recibirá un correo de confirmación para activar la cuenta en su dirección de correo electrónico.
6. Introduzca una contraseña. Las contraseñas detectan mayúsculas y minúsculas. La contraseña debe tener entre 6 y 12 caracteres. Recuerde su ID y su contraseña. Las usará con la aplicación LG Smart Laundry para acceder a las funciones de conectividad del electrodoméstico inteligente.
7. Introduzca su nombre.
8. Introduzca su número de teléfono celular.

9. Pulse el botón Subscribe (suscribirse). El sistema le enviará un correo electrónico con un enlace para confirmar su identidad para la cuenta.
10. Pulse el botón CONFIRM (confirmar) en el correo electrónico de confirmación y el sitio web desplegará la página de confirmación. Su cuenta ya está configurada.

### Configuración de registro del producto y de la red Wi-Fi.

1. Ejecute la aplicación LG Smart Laundry en su teléfono inteligente.
2. Seleccione Smart Appliance (electrodoméstico inteligente)
3. Seleccione Dryer (Secadora)
  - Si aparece un mensaje emergente sobre NFC, presione el botón Cancel.
4. Pulse el botón Wi-Fi model (modelo con Wi-Fi) en la parte inferior de la pantalla.
5. Introduzca el correo de ID y la contraseña que utilizó para registrarse. Si no tiene una cuenta en <http://us.smartthinQ.com>, pulse el botón *Create an account* (crear una cuenta) para crear la ID de usuario y contraseña.
6. Seleccione el botón Login (inicio de sesión).
7. En la siguiente página, la aplicación muestra la lista de redes Wi-Fi. Seleccione la red de su hogar. Si su red necesita una clave, introduzca la contraseña y seleccione el botón Connect (conectar).
8. Si la aplicación se conecta correctamente a la red doméstica, encienda la secadora y luego mantenga presionado el botón Wi-Fi Connect de la secadora durante tres segundos. Después de encender la secadora, no presione ningún otro botón antes de mantener presionado el botón Wi-Fi Connect. El indicador de conexión Wi-Fi de la secadora parpadea para indicar que la máquina se está conectando.

9. La aplicación ahora trabaja para conectar el aparato y registrarlo como un producto Wi-Fi.  
Aparece una notificación cuando la secadora se ha configurado con éxito y cuando se ha completado el registro del producto y la configuración de Wi-Fi. El indicador de conexión Wi-Fi se enciende cuando la máquina se conecta a la red doméstica.

### ! NOTA

- La máquina solo admite una red de WiFi de 2,4 GHz.
- Utilice el menú Settings de la aplicación para registrar o cambiar la máquina. Seleccione Settings > Change Product > Add Product y luego siga los pasos 2–9 que figuran aquí arriba.
- Si el router o la contraseña del router se ha cambiado, seleccione Settings > Change Product > Add Product y luego siga los pasos 2–9 que figuran aquí arriba.
- Si el aparato tiene problemas para conectarse a la red Wi-Fi, es posible que se encuentre demasiado lejos del router. Adquiera un repetidor Wi-Fi (extensor de alcance) para mejorar la intensidad de la señal Wi-Fi.
- Es posible que la conexión Wi-Fi no se conecte o se interrumpa debido al entorno de la red doméstica.
- Es posible que la conexión de red no funcione bien por cuestiones relacionadas con su proveedor de servicios de Internet.
- El entorno inalámbrico circundante puede hacer que el servicio de red inalámbrica funcione lentamente.
- Esta información está actualizada en el momento de su publicación. La aplicación está sujeta a cambios con fines de mejorar el producto sin previo aviso a los usuarios.

## Smart ThinQ™

### Inicio remoto

Use un teléfono inteligente para controlar su electrodoméstico de manera remota. También es posible monitorear el funcionamiento del ciclo para saber cuánto tiempo le queda al ciclo.

### ! NOTA

- En primer lugar, debe conectarse a una puerta de enlace y registrar su electrodoméstico para usar la función de inicio remoto.
- El LED remoto en el panel de control debe estar iluminado.

### Uso de Remote Start

1. Presione y sostenga el botón de inicio remoto. El LED remoto en el panel de control debe estar iluminado si su electrodoméstico está conectado a una red Wi-Fi.
2. Inicie un ciclo desde la aplicación de su teléfono inteligente. Si no se inicia el ciclo, la máquina esperará para comenzar el ciclo hasta que se apague de forma remota desde la aplicación o hasta que se desactive el modo Remote Start.

### ! NOTA

- Cuando la máquina se encuentra en el modo Remote Start, no se pueden seleccionar los ciclos y las opciones desde el artefacto.
- Mantenga presionado el botón Remote Start nuevamente para activar el modo Remote Start cuando el artefacto esté apagado o el modo Remote Start esté desactivado.

### Red inteligente

Reduzca los costos energéticos que implica el secado de ropa evitando usar el equipo en períodos de uso máximo, con la información suministrada por su compañía eléctrica local.

Si la compañía de servicios ha equipado su hogar con la tecnología Smart Grid, deberá contactarse con ellos para obtener información sobre las características de esta red.

### ! NOTA

- Cuando está activado Smart Grid, puede experimentar demoras o períodos de ciclo extendidos durante los momentos de mayor consumo.

### ! NOTA

- En primer lugar, debe conectarse a un portal de enlaces y registrar su electrodoméstico para poder utilizar la función Smart Grid.

### Descarga de ciclo

Las funciones de descarga de ciclo que posee este electrodoméstico permiten descargar ciclos nuevos y especiales que no están incluidos en los ciclos básicos del aparato.

Los aparatos que se han registrado con éxito pueden descargar una serie de ciclos especiales y específicos para el electrodoméstico.

Se puede almacenar solo un ciclo por vez en el electrodoméstico.

Una vez que la descarga del ciclo está completa en secadora, el producto mantiene el ciclo descargado hasta que se cambie por una nueva descarga de ciclo.

#### ! NOTA

- En primer lugar se debe conectar a un portal de enlace y registrar el electrodoméstico para poder usar la función de descarga del ciclo.

### Smart Diagnosis™

Use su teléfono para guardar la señal Smart Diagnosis™ si tiene problemas con su electrodoméstico. La aplicación puede analizar la señal y ayudarlo a resolver el problema sin necesidad de esperar a un técnico.

### Configuración del ciclo

La configuración del ciclo le ayuda a elegir el mejor ciclo y ajustes en función de sus necesidades de lavado.

Una vez seleccionado el ciclo según la guía de configuración del ciclo, el ciclo y los ajustes quedan automáticamente programados.

#### ! NOTA

- Se puede activar la función Cycle Set (configuración del ciclo) cuando el botón de inicio remoto está activado.

### Estadísticas de lavado

Las estadísticas de lavado indicarán las estadísticas básicas de su electrodoméstico, es decir, el historial de ciclos y el cronograma de mantenimiento básico.

Seleccione Laundry Stats en la aplicación para obtener las estadísticas y conocer el estado de ventilación de la secadora.

#### ! NOTA

- En primer lugar debe conectarse a un portal de enlace y registrar el electrodoméstico para poder usar la función de estadísticas de lavado.

### Mensaje inteligente

Cuando el ciclo esté completo o el electrodoméstico tenga problemas, tiene la opción de recibir notificaciones automáticas en su teléfono inteligente.

#### ! NOTA

- En primer lugar debe conectarse a un portal de enlace y registrar el electrodoméstico para poder usar la función de mensajes inteligentes.

### Monitoreo de la energía

El consumo energético de la secadora se ve afectado por el ciclo y las opciones, de modo que es posible que se observen algunos cambios en el consumo energético de un ciclo al otro.

#### ! NOTA

- En primer lugar debe conectarse a un portal de enlace y registrar el electrodoméstico para poder usar la función de monitoreo de energía.

## UTILIZACIÓN DEL Smart Diagnosis™

Si tuviera algún problema con su secadora, la misma posee la capacidad de transmitir datos a un teléfono inteligente utilizando la aplicación Smart Laundry&DW de LG o mediante el teléfono al Centro de atención telefónica de LG. Smart Diagnosis™ no puede ser activado a menos que su secadora esté encendida pulsando el botón de Alimentación(Power). Si su secadora no puede encenderse, tendrá que localizar y solucionar los problemas sin utilizar Smart Diagnosis™.

### Diagnóstico sonoro

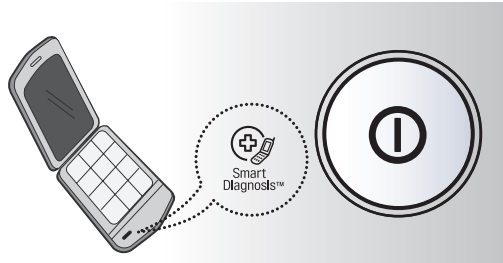

### Smart Diagnosis™ utilizando su teléfono inteligente

1. Descargue la aplicación Smart Laundry&DW de LG en su teléfono inteligente.
2. Abra la aplicación Smart Laundry&DW de LG en su teléfono inteligente. Presione el botón flecha hacia la derecha para avanzar a la siguiente pantalla.
3. Presione el botón Grabación del teléfono inteligente y mantenga la boquilla del teléfono inteligente junto al logotipo de Smart Diagnosis™ de la secadora.
4. Con el teléfono en su sitio, pulse y mantenga pulsado el botón de Temperatura(Temp.) durante tres segundos.
5. Mantenga el teléfono en el sitio hasta que la transmisión del tono haya terminado. Necesita tiempo en el panel visualizado.
6. Al finalizar la grabación, vea el resultado del diagnóstico presionando el botón Siguiente del teléfono.

#### ! NOTA

“Smart Diagnosis™(Diagnóstico Inteligente) es una función de resolución de problemas diseñada para asistir, no reemplazar, al método tradicional de resolución de problemas a través de llamadas de servicio técnico. La efectividad de esta función depende de diversos factores, entre los cuales se incluyen, la recepción del teléfono celular utilizado para la transmisión, cualquier ruido externo que pueda presentarse durante la transmisión, y la acústica de la habitación donde está ubicada la secadora. Por lo tanto, LG no garantiza que SmartDiagnosis resuelva con precisión cualquier cuestión dada.”

### Smart Diagnosis™ a través del Centro de atención telefónica

1. Llame al Centro de atención telefónica de LG Electronics al teléfono: (LG EE.UU.) 1-800-984-6306 (LG Canadá) 1-888-542-2623.
2. Cuando se lo indique el agente del Centro de atención telefónica, mantenga el micrófono de su teléfono sobre el logotipo Smart Diagnosis™ del equipo. Sostenga el teléfono a no más de una pulgada o 2.5 cm (pero sin tocar) el equipo.

#### ! NOTA

No toque ningún otro botón ni icono de la pantalla.

3. Pulse y mantenga pulsado el botón de Temperatura(Temp.) durante tres segundos.
4. Mantenga el teléfono en el sitio hasta que la transmisión del tono haya terminado. Necesita tiempo en el panel visualizado.
5. Una vez que la cuenta regresiva haya finalizado y los tonos se hayan detenido, reanude la conversación con el agente del Centro de atención telefónica, que será capaz de ayudarlo en la utilización de la información transmitida para su análisis.

# MANTENIMIENTO

## Limpeza regular

### ⚠ ADVERTENCIA

Para reducir el riesgo de incendio, descargas eléctricas o heridas al usar su electrodoméstico, siga las precauciones básicas, incluyendo lo siguiente:

• **Desenchufe la secadora antes de limpiar la misma para evitar el riesgo de descargas eléctricas.**

Si no se cumple con esta advertencia se podrán producir heridas graves, incendios, descargas eléctricas o muerte.

• **Al limpiar la secadora nunca utilice químicos de corte, limpiadores abrasivos o solventes.**

Los mismos dañarán su aspecto.

### Limpeza del exterior

El mantenimiento adecuado de su secadora podría prolongar su vida útil. El exterior de la unidad puede limpiarse con agua tibia y un detergente de jabón medio, no abrasivo.

Limpie inmediatamente cualquier clase de fuga, con un trapo suave y húmedo.

### ! NOTA

No use alcohol desnaturalizado, disolventes o productos similares.

Nunca use limpiadores abrasivos o de lana metálica; pueden dañar la superficie.

### Limpeza del interior

Limpie con un paño alrededor de la abertura y el sello de la puerta con un paño suave húmedo para prevenir la acumulación de pelusa y polvo que podrían dañar el sello de la puerta.

Limpie la ventanilla con un paño suave humedecido con agua caliente y un detergente suave no abrasivo para el hogar; luego seque con un paño.

Se puede limpiar el tambor de acero inoxidable con un limpiador de acero inoxidable convencional, usado según las especificaciones del fabricante. Nunca use limpiadores abrasivos ni de lana metálica; pueden raspar o dañar la superficie.

### Limpeza alrededor y debajo de la secadora

Aspire la pelusa y polvo alrededor de la secadora y debajo de ella con regularidad. Se debe revisar que el sistema de conductos de ventilación no tenga acumulación de pelusa y se debe limpiar una vez por año. Si se percibe una reducción del flujo de aire o desempeño del secado notorios, revise que el sistema de conductos no esté bloqueado ni tenga obstrucciones.

### Mantenimiento del sistema de conductos

Se debe revisar que el sistema de conductos de ventilación no tenga acumulación de pelusa y se debe limpiar una vez por año. Si se percibe una reducción del flujo de aire o desempeño del secado notorios, revise que el sistema de conductos no esté bloqueado ni tenga obstrucciones. Llame a un técnico o proveedor de mantenimiento calificados.

### Limpeza del filtro de pelusa

Limpie siempre el filtro de pelusa después de cada ciclo.

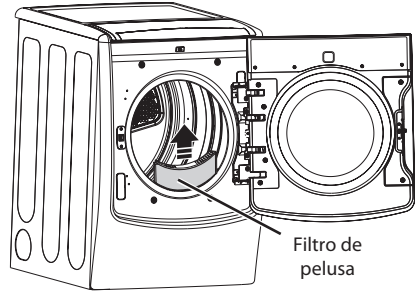

Para limpiarlo, tire del filtro de pelusa verticalmente. Luego:

1. Con los dedos, enrolle cualquier pelusa para retirarla del filtro, o

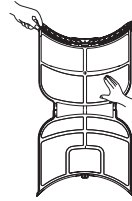

2. Limpie el filtro de pelusa con un aspirador, o

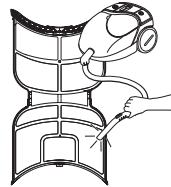

3. Si el filtro de pelusas se ha ensuciado mucho o se ha obstruido con suavizante de tejido, lávelo en agua caliente jabonosa y déjelo secar completamente antes de volverlo a colocar.

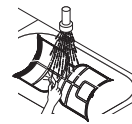

### ! NOTA

NUNCA opere la secadora sin haber colocado antes el filtro de pelusa. NUNCA haga funcionar la secadora con un filtro de pelusas húmedo.



## RESOLUCIÓN DE PROBLEMAS

### Antes de llamar a mantenimiento

Su secadora está equipada con un sistema de monitoreo de errores automático para la detección y el diagnóstico de problemas en una etapa temprana. Si su secadora no funciona adecuadamente o no funciona en lo absoluto, revise lo siguiente antes de llamar a mantenimiento.

Problema	Causas posibles	Soluciones
La secadora no se enciende	<ul style="list-style-type: none"> <li>• El cable eléctrico no está enchufado adecuadamente.</li> <li>• El fusible del hogar está quemado, el cortacircuitos se ha accionado, o ha ocurrido una interrupción eléctrica.</li> </ul>	<ul style="list-style-type: none"> <li>• Asegúrese de que el enchufe esté conectado de manera segura en un tomacorriente con conexión a tierra, que se corresponda con la placa de clasificación.</li> <li>• Reactive el disyuntor o cambie el fusible. No aumente la capacidad del fusible. Si el problema se debe a una sobrecarga de circuito, pida a un electricista calificado que solucione el problema.</li> </ul>
La secadora no calienta	<ul style="list-style-type: none"> <li>• El fusible del hogar está quemado, el cortacircuitos se ha accionado, o ha ocurrido una interrupción eléctrica.</li> <li>• Se ha apagado el suministro o servicio de gas (sólo modelos a gas).</li> <li>• La opción de ahorro de energía (Energy Saver) está seleccionada</li> </ul>	<ul style="list-style-type: none"> <li>• Reactive el disyuntor o cambie el fusible. No aumente la capacidad del fusible. Si el problema se debe a una sobrecarga de circuito, pida a un electricista calificado que solucione el problema.</li> <li>• Confirme que la válvula de corte de gas de la vivienda y la válvula de corte de gas de la secadora estén completamente abiertas.</li> <li>• Si utiliza el ciclo Algodón/Normal, desactive la opción de ahorro de energía. La opción de ahorro de energía se selecciona de forma predeterminada y permite reducir el consumo de energía, ya que incorpora una sección de secado por aire al comienzo del ciclo. Es normal que sienta que la secadora no calienta al comienzo del ciclo cuando el modo de ahorro de energía está seleccionado.</li> </ul>
Manchas de grasa o suciedad en las prendas	<ul style="list-style-type: none"> <li>• Suavizador de telas usado incorrectamente.</li> <li>• Prendas limpias y sucias secadas juntas.</li> </ul>	<ul style="list-style-type: none"> <li>• Confirme y siga las instrucciones provistas con su suavizador de telas.</li> <li>• Asegúrese de usar su secadora solo para secar artículos limpios, ya que los artículos sucios pueden ensuciar las prendas limpias en la misma carga o en las subsiguientes.</li> <li>• Las manchas en ropas secas son en realidad manchas que no se eliminaron durante los procesos de lavado. Asegúrese de que las ropas queden completamente limpias de acuerdo con las instrucciones de su lavadora y detergente.</li> </ul>
La pantalla muestra los errores tE1 o tE2	<ul style="list-style-type: none"> <li>• No está funcionando el calefactor.</li> </ul>	<ul style="list-style-type: none"> <li>• Apague la secadora y llame a mantenimiento.</li> </ul>
Pelusa en las prendas	<ul style="list-style-type: none"> <li>• No se ha limpiado correctamente el filtro de pelusa.</li> <li>• Prendas de lavado no clasificadas adecuadamente.</li> <li>• Exceso de estática en las prendas.</li> <li>• La secadora está sobrecargada.</li> <li>• Pañuelos de papel, papeles, etc. dejados en los bolsillos.</li> </ul>	<ul style="list-style-type: none"> <li>• Asegúrese de limpiar el filtro de pelusa antes de cada carga. Con algunas cargas que producen altas cantidades de pelusa, puede ser necesario limpiar el filtro durante el ciclo.</li> <li>• Algunas telas producen pelusas (por ejemplo: una toalla de algodón peluda blanca) y deben secarse aparte de las prendas que atrapan pelusa (por ejemplo: un par de pantalones de lino).</li> <li>• Observe el exceso de estática en las prendas después del secadora indicado de la sección más abajo.</li> <li>• Divida las cargas grandes en cargas más pequeñas para realizar el secado.</li> <li>• Revise los bolsillos minuciosamente antes de lavar y secar prendas.</li> </ul>
Exceso de estática en las prendas después del secado	<ul style="list-style-type: none"> <li>• No se usa suavizador de tela o se usa incorrectamente.</li> <li>• Las prendas se secan por demasiado tiempo (excesivamente secas).</li> <li>• Secado de telas sintéticas, planchado permanente o combinación de materiales sintéticos.</li> </ul>	<ul style="list-style-type: none"> <li>• Use un suavizador de telas para reducir la electricidad estática. Asegúrese de seguir las instrucciones del fabricante.</li> <li>• Sobrecargar una carga de lavado puede causar la acumulación de electricidad estática. Programe los ajustes y use un tiempo de secado menos prolongado; o use los ciclos SECADO CON SENSOR (SENSOR DRY).</li> <li>• Estos materiales pueden causar acumulación de estática. Intente usar un suavizador de telas.</li> </ul>
La pantalla muestra el código de error PS	<ul style="list-style-type: none"> <li>• El cable de alimentación está mal conectado.</li> </ul>	<ul style="list-style-type: none"> <li>• Compruebe la conexión del cable de alimentación al bloque de terminales. Consulte las páginas 26-29 de este manual.</li> </ul>

## Antes de llamar a mantenimiento (cont.)

Problema	Causas posibles	Soluciones
El tiempo de secado no concuerda.	<ul style="list-style-type: none"> <li>Los ajustes de calor, el tamaño de la carga o la humedad de las prendas no son constantes.</li> </ul>	<ul style="list-style-type: none"> <li>El tiempo de secado para una carga variará dependiendo del ajuste de calor, tipo de calor utilizado (eléctrico, natural, o gas LP), el tamaño de la carga, el tipo de tela, el nivel de humedad de las prendas y la condición de los conductos de escape y el filtro de pelusa.</li> </ul>
Las prendas tardan demasiado tiempo en secarse	<ul style="list-style-type: none"> <li>La carga no está correctamente clasificada.</li> <li>Carga grande de telas pesadas.</li> <li>No se han programado adecuadamente los controles de la secadora.</li> <li>Se necesita limpiar el filtro de pelusa.</li> <li>Los conductos de escape están bloqueados, sucios o el tendido de los conductos es demasiado largo.</li> <li>El fusible del hogar está quemado, el cortacircuitos se ha accionado, o ha ocurrido una interrupción eléctrica.</li> <li>La secadora está sobrecargada.</li> <li>Hay muy poca carga en la secadora.</li> <li>La opción de ahorro de energía (Energy Saver) está seleccionada</li> </ul>	<ul style="list-style-type: none"> <li>Separe los artículos pesados de los livianos. Los artículos más grandes y pesados requieren de mayor tiempo de secado.</li> <li>Las telas pesadas requieren de mayor tiempo de secado ya que tienden a retener mayor humedad. Para ayudar a reducir y mantener tiempos de secado más constantes para telas pesadas y de mayor tamaño, separe estos artículos en cargas más pequeñas de un tamaño sistemático.</li> <li>Use los ajustes de control adecuados para el tipo de carga que esté secando.</li> <li>Asegúrese de limpiar el filtro de pelusa antes de cada carga. Con algunas cargas que producen altas cantidades de pelusa, puede ser necesario limpiar el filtro durante el ciclo.</li> <li>Confirme que el sistema de conducto de escape se encuentre configurado correctamente y no tenga desechos, pelusa ni obstrucciones. Asegúrese de que los reguladores de tiro exteriores abran adecuadamente y no estén bloqueados, atascados ni dañados.</li> <li>Reactive el disyuntor o cambie el fusible. No aumente la capacidad del fusible. Si el problema se debe a una sobrecarga de circuito, pida a un electricista calificado que solucione el problema.</li> <li>Divida las cargas grandes en cargas más pequeñas para realizar el secado.</li> <li>Si está secando una carga muy pequeña, añada algunos artículos adicionales para asegurar una acción de giro apropiada.</li> <li>Si utiliza el ciclo Algodón/Normal, desactive la opción de ahorro de energía. Esta opción permite reducir el consumo de energía, ya que incorpora una sección de secado por aire al comienzo del ciclo.</li> </ul>
Las prendas están arrugadas	<ul style="list-style-type: none"> <li>Las prendas se secaron por demasiado tiempo (excesivamente secas).</li> <li>Se han dejado las prendas en la secadora por demasiado tiempo una vez finalizado el ciclo.</li> </ul>	<ul style="list-style-type: none"> <li>Secar excesivamente una carga de lavandería puede provocar arrugas en las prendas. Intente secar por un periodo menos prolongado y retire los artículos mientras aún retienen una cantidad leve de humedad.</li> <li>Retire inmediatamente todos los artículos de la secadora al final del ciclo. Use la opción CUIDADO DE ARRUGAS (WRINKLE CARE) para continuar girando las prendas al final de un ciclo, por un plazo máximo de 3 horas.</li> </ul>
Las prendas encogen	<ul style="list-style-type: none"> <li>No se siguen las instrucciones de la etiqueta de la prenda.</li> </ul>	<ul style="list-style-type: none"> <li>Para evitar que las prendas encojan, siga cuidadosamente las instrucciones de cuidado de telas correspondiente a su prenda, ya que algunas telas encogen naturalmente cuando se lavan. Otras telas se pueden lavar, pero encogen cuando se secan en una secadora. Use un ajuste de calor bajo o sin calor.</li> </ul>
La luz de AÑADIR AGUA (ADD) esta encendida durante el ciclo de secado	<ul style="list-style-type: none"> <li>Error de entrada de agua.</li> </ul>	<ul style="list-style-type: none"> <li>Verifique el cajón del alimentador de vapor:           <ol style="list-style-type: none"> <li>El alimentador de vapor debe estar lleno de agua hasta la línea MAX.</li> <li>Constate que el alimentador de vapor esté bien colocado y que el cajón esté completamente cerrado.</li> <li>Apague la secadora, luego vuelva a iniciar el ciclo de vapor.</li> </ol> </li> <li>No use agua destilada; el sensor de nivel de agua del generador de vapor no funcionará.</li> <li>No funciona la bomba. Desenchúfe la secadora y llame al servicio técnico.</li> </ul>
Gotea agua de la boquilla cuando comienza el ciclo de vapor	<ul style="list-style-type: none"> <li>Esto es normal.</li> </ul>	<ul style="list-style-type: none"> <li>Esto es condensación de vapor. El agua parará de gotear después de un tiempo.</li> </ul>
El visualizador muestra "d80", "d90", "d95"  	<ul style="list-style-type: none"> <li>Los conductos están bloqueados al 80%, 90%~95% aproximadamente. (el código de error "d80", "d90" o "d95" sólo se visualiza durante 2 horas)</li> <li>Sistema de escape doméstico bloqueado.</li> </ul>	<ul style="list-style-type: none"> <li><b>No utilice la secadora hasta que el sistema de escape no haya sido limpiado y/o reparado.</b> Utilizar la secadora con un escape gravemente restringido es peligroso y podría conllevar un incendio u otros daños a la propiedad.</li> <li>Compruebe la ventilación externa de la secadora cuando la misma está funcionando para asegurarse que el flujo de aire es potente.</li> <li>Si el sistema de escape es extremadamente largo, hágalo reparar o desviar.</li> <li>Mantenga la zona alrededor de la secadora limpia y libre de desorden.</li> <li>Compruebe los daños en la campana de la ventilación o el atasco de pelusas.</li> <li>Asegúrese que la zona alrededor de la campana de ventilación está despejada.</li> </ul>



## Antes de llamar a mantenimiento (cont.)

Problema	Causas posibles	Soluciones
No se produce vapor pero no aparece ningún código de error	<ul style="list-style-type: none"> <li>• Error de nivel de agua.</li> </ul>	<ul style="list-style-type: none"> <li>• Desenchufe la secadora y llame al servicio técnico.</li> </ul>
Las prendas siguen arrugadas después del ciclo STEAM FRESH™	<ul style="list-style-type: none"> <li>• Demasiadas prendas o prendas muy diferentes en la secadora.</li> </ul>	<ul style="list-style-type: none"> <li>• Cargas pequeñas de 1 a 5 prendas funcionan mejor.</li> <li>• Cargue menos prendas. Cargue prendas de clase similar.</li> </ul>
No quedan rayas en la ropa después de STEAM FRESH™	<ul style="list-style-type: none"> <li>• La función de este ciclo es quitar las arrugas de las telas.</li> </ul>	<ul style="list-style-type: none"> <li>• Use una plancha para hacer las rayas.</li> </ul>
Gotea agua de la puerta durante el ciclo de vapor	<ul style="list-style-type: none"> <li>• Esto es normal.</li> </ul>	<ul style="list-style-type: none"> <li>• Normalmente, se forma condensación en el interior de la puerta de la secadora durante el funcionamiento de vapor. Puede gotear la condensación desde el fondo de la puerta.</li> </ul>
No se ve vapor durante el ciclo de vapor	<ul style="list-style-type: none"> <li>• Esto es normal.</li> </ul>	<ul style="list-style-type: none"> <li>• Es difícil ver el vapor con la puerta cerrada. Sin embargo, la condensación se forma normalmente en el interior de la puerta de la secadora si el sistema funciona con normalidad.</li> </ul>
El tambor no gira durante el ciclo de vapor	<ul style="list-style-type: none"> <li>• Esto es normal.</li> </ul>	<ul style="list-style-type: none"> <li>• El tambor está apagado para que el vapor permanezca en el tambor. Normalmente, el tambor gira aproximadamente 2 segundos cada minuto.</li> </ul>
No se ve vapor al comienzo del ciclo	<ul style="list-style-type: none"> <li>• Esto es normal.</li> </ul>	<ul style="list-style-type: none"> <li>• El vapor se libera en diferentes etapas del ciclo para cada opción.</li> </ul>
La pantalla muestra carga voluminosa 	<ul style="list-style-type: none"> <li>• El botón MÁS TIEMPO (MORE TIME) está presionado.</li> </ul>	<ul style="list-style-type: none"> <li>• Esta pantalla indica que la opción de vapor se ha ajustado para un elemento "grande", por ejemplo, un edredón. Pulse el botón LESS TIME (MENOS TIEMPO) para reducir el tamaño de carga indicado.</li> </ul>
Olores restantes en la ropa después de STEAM FRESH™	<ul style="list-style-type: none"> <li>• STEAM FRESH™ no eliminó completamente el olor.</li> </ul>	<ul style="list-style-type: none"> <li>• Lave las telas que contienen los olores en un ciclo de lavado normal.</li> </ul>
La luz de REVISE EL FILTRO (CHECK FILTER) esta encendida durante el ciclo de secado	<ul style="list-style-type: none"> <li>• El filtro de pelusa está casi atascado o lleno.</li> </ul>	<ul style="list-style-type: none"> <li>• Pause el ciclo de secado y limpie el filtro de pelusa.</li> </ul>
El indicador Flow Sense™ muestra cuatro barras durante el ciclo de secado o la pantalla muestra "d80" luego del secado.	<ul style="list-style-type: none"> <li>• La tubería es demasiado larga o posee muchos giros/restricciones.</li> <li>• Bloqueo significativo de la tubería por acumulación de pelusa o escombros.</li> <li>• El electrodoméstico ha detectado una obstrucción en la ventilación externa de la secadora.</li> </ul>	<ul style="list-style-type: none"> <li>• Instale un conducto más corto o más derecho. Lea las Instrucciones de Instalación.</li> <li>• La tubería se deberá controlar/limpiar de inmediato para eliminar la pelusa acumulada y otros bloqueos. La secadora se puede usar, pero su funcionamiento y eficacia se verán reducidos de forma importante.</li> <li>• Si el sistema Flow Sense™ detecta restricciones de salida, el indicador permanecerá encendido durante dos horas tras finalizar el ciclo. Si abre la puerta o pulsa el botón Encendido/Apagado (Power), se apagará la pantalla.</li> </ul>

## ESPECIFICACIONES

<b>Secador con Vapor</b>		<b>DLEX9500* DLGX9501*</b>
Descripción	Secadora con vapor	
Requisitos eléctricos	Consulte la placa de clasificación para información en detalles.	
Requisitos de gas	NG: 4 a 10,5 pulgadas WC LP: 8 a 13 pulgadas WC	
Dimensiones	29" (ancho) X 33 <sup>3</sup> / <sub>8</sub> " (profundidad) X 40 <sup>7</sup> / <sub>8</sub> " (alto), 56" (D con la puerta abierta) 74,0 cm (ancho) X 84,8 cm (profundidad) X 103,9 cm (alto), 143,0 cm (D con la puerta abierta)	
Peso neto	Secadoras a gas : 160,7 lbs(72,9 kg) Secadoras electricas : 157,4 lbs(71,4 kg)	
Capacidad de secado		
- Ciclo de normal	IEC 9,0 pies cubicos (27,3 lbs/12,4 kg)	
- Ciclo de vapor	IEC 9,0 pies cubicos (8 lbs/3,6 kg)	

# GARANTÍA (EE. UU.)

Si su secadora LG (el "Producto") fallara debido a defectos de materiales o de fabricación en el uso doméstico normal, durante el período de garantía que se establece a continuación, LG tendrá la opción de reparar o reemplazar el producto. Esta garantía limitada solo es válida para el comprador minorista original del producto y será vigente solo cuando se compre y use dentro de los Estados Unidos y de los territorios estadounidenses. Se exige el comprobante de compra minorista original para solicitar servicio por garantía según esta garantía limitada.

Período de garantía	Alcance de la garantía	CÓMO SE MANEJA EL SERVICIO TÉCNICO
Un (1) año a partir de la fecha de compra minorista original	Piezas y mano de obra	LG suministrará las piezas y la mano de obra para reparar o reemplazar las piezas defectuosas.
Diez (10) años a partir de la fecha de compra minorista original	Tambor de la secadora	Solo las piezas. El cliente será responsable de cualquier trabajo o servicio realizado en su casa para reemplazar las piezas defectuosas.

- Los productos y las piezas de repuesto están garantizados durante el tiempo restante del período original de garantía o noventa (90) días, lo que resulte mayor.
- Los productos y las piezas de repuesto pueden ser nuevos o reparados.

**ESTA GARANTÍA REEMPLAZA CUALQUIER OTRA GARANTÍA, EXPRESA O IMPLÍCITA, LO QUE INCLUYE SIN LÍMITE, LAS GARANTÍAS DE APTITUD COMERCIAL O IDONEIDAD PARA UN FIN EN PARTICULAR. SALVO POR LAS GARANTÍAS IMPLÍCITAS EXIGIDAS POR LA LEY, ES DE DURACIÓN LIMITADA AL PERÍODO DE GARANTÍA EXPRESA MENCIONADO ANTERIORMENTE. NI EL FABRICANTE NI SU DISTRIBUIDOR EN LOS ESTADOS UNIDOS SERÁN RESPONSABLES DE NINGÚN DAÑO INCIDENTAL, EMERGENTE, INDIRECTO NI PUNITIVO DE NINGÚN TIPO, LO QUE INCLUYE SIN LÍMITE, INGRESOS O GANANCIAS PERDIDOS O CUALQUIER OTRO DAÑO CONTRACTUAL, EXTRA CONTRACTUAL O DE OTRO TIPO.**

Algunos estados no permiten la exclusión o limitación de daños incidentales o emergentes, o limitaciones a la duración de la garantía implícita, por lo que la exclusión o limitación anteriormente mencionadas podrían no corresponder en su caso. Esta garantía le otorga derechos legales específicos y es posible que usted cuente con otros derechos que varían según el estado.

## ESTA GARANTÍA LIMITADA NO CUBRE LO SIGUIENTE:

- Viajes del servicio técnico para entregar, buscar, o instalar o reparar el producto; instrucciones al cliente sobre la operación del producto; reparación o reemplazo de fusibles o corrección de cableado o fontanería, o corrección de reparaciones/instalaciones no autorizadas.
- Incapacidad del producto para funcionar debido a fallas e interrupciones del suministro eléctrico, o a un servicio eléctrico inadecuado.
- Daños causados por tuberías de agua rotas o con fugas, tuberías de agua congeladas, líneas de drenaje restringidas, suministro de agua inadecuado o interrumpido, o suministro de aire inadecuado.
- Daños resultantes de operar el producto en una atmósfera corrosiva o contraria a las instrucciones esbozadas en el manual del propietario del producto.
- Daños al producto causados por accidentes, pestes y alimañas, rayos, viento, incendio, inundaciones o hechos de fuerza mayor.
- Daños o fallas causados por modificaciones o alteraciones no autorizadas, o si se usa para otro fin que no sea el previsto, o por fugas de agua donde la unidad no se haya instalado correctamente.
- Daños o fallas causados por corriente o voltaje eléctricos incorrectos, o por códigos de fontanería, por uso comercial o industrial, o por uso de accesorios, componentes o productos de limpieza consumibles no aprobados por LG.
- Daños causados por el transporte y el manejo, incluye rayas, muescas, astillado y otros daños al acabado del producto, a menos que tales daños resulten de defectos de los materiales o de la fabricación y se informen dentro del plazo de una (1) semana de la entrega.
- Daños o artículos faltantes a productos reacondicionados, comprados con descuento, con la caja abierta o que hayan estado en exhibición.
- Productos cuyos números de serie originales hayan sido retirados, alterados o no se puedan determinar fácilmente. Los números de serie y de modelo, junto con el comprobante de venta minorista original, son necesarios para validar la garantía.
- Aumentos en los costos de los servicios públicos y otros gastos adicionales de dichos servicios.

- Reparaciones cuando el producto se use de otra forma que no sea uso doméstico usual y normal (p. ej., uso comercial, en oficinas e instalaciones recreativas) o contraria a las instrucciones esbozadas en el manual del propietario del producto.
- Costos asociados con el retiro del producto de su casa para realizar reparaciones.
- El retiro y la reinstalación del producto si está instalado en un lugar inaccesible o no está instalado de acuerdo con las instrucciones de instalación publicadas, lo que incluye los manuales de instalación y del propietario de LG.
- Daños resultantes de mal uso, abuso, instalación, reparación o mantenimiento incorrectos. Una reparación incorrecta incluye el uso de piezas no aprobadas o especificadas por LG.

#### El filtro está tapado.

- La secadora no calienta, tiempo de secado prolongado.

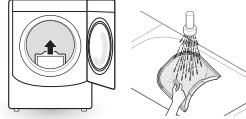

- Limpie el filtro de pelusa.

#### El conducto está tapado.

- La secadora no calienta, tiempo de secado prolongado.

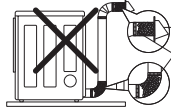

- Limpie la campana y el conducto.

#### Conducto demasiado largo y/o con múltiples codos.

- La secadora no calienta, tiempo de secado prolongado.

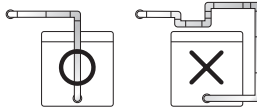

- Mantenga los conductos de escape lo más cortos que sea posible y use la menor cantidad de codos y curvas como le sea posible.

#### Cable de alimentación mal conectado o problema con la toma de corriente eléctrica.

- Sin corriente
- No calienta

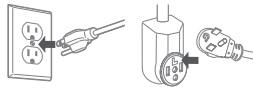

- Vuelva a conectar el cable de alimentación, reemplace el fusible de la casa o vuelva a iniciar el disyuntor. Si el problema es la toma de corriente, es probable que necesite llamar a un electricista.

#### La válvula de gas no está abierta. (Secadora de gas).

- No calienta

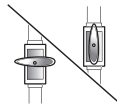

- Abra la válvula de gas.

#### Inversión de la puerta.

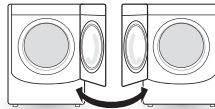

- Las instrucciones para la inversión de la puerta pueden encontrarse en el manual del usuario.

**El costo de la reparación o el reemplazo en estas circunstancias excluidas estarán a cargo del consumidor.**

#### CÓMO OBTENER SERVICIO EN GARANTÍA E INFORMACIÓN ADICIONAL

Si usted no tiene acceso a Internet y necesita asistencia para el uso de su producto o desea programar un servicio técnico, puede comunicarse con LG Electronics al número que aparece a continuación.

Para obtener asistencia o servicio técnico, llame al 1-800-984-6306.

Si necesita más ayuda, puede escribir a LG para dirigir sus preguntas o inquietudes a la dirección que aparece a continuación:

LG Electronics, 201 James Record Road, Huntsville, Alabama 35813

Para obtener más información sobre el producto, visite nuestro sitio web en <http://www.lg.com>











# LG SIGNATURE

Customer Information Center

For inquires or comments, call;

1-800-984-6306 USA, Consumer User  
1-888-865-3026 USA, Commercial User  
1-888-542-2623 CANADA