

READ ALL INSTRUCTIONS BEFORE USE

The following safety guidelines are intended to prevent unforeseen risks or damage from unsafe or incorrect operation of the appliance.

The guidelines are separated into 'WARNING' and 'CAUTION' messages as described below.

Safety Messages

**⚠** This symbol is displayed to indicate matters and operations that can cause risk. Read the text marked with this symbol carefully and follow the instructions in order to avoid risk.

**⚠ WARNING**  
This indicates that the failure to follow the instructions can cause serious injury or death.

**⚠ CAUTION**  
This indicates that the failure to follow the instructions can cause minor injury or damage to the product.

WARNING

**⚠ WARNING**  
To reduce the risk of explosion, fire, death, electric shock, injury or scalding to persons when using this product, follow basic precautions, including the following:

- This appliance should only be installed and transported by two or more people holding the pedestal securely.
- Unplug the front-loading washing machine or dryer before stacking it on top of the pedestal.
- Keep flammable materials and vapors, such as gasoline, away from dryer.
- Place dryer at least 18 inches above the floor for a garage installation.

Parts and Dimensions

The images in this guide may be different from the actual components and accessories, which are subject to change by the manufacturer without prior notice for product improvement purposes.

Front View

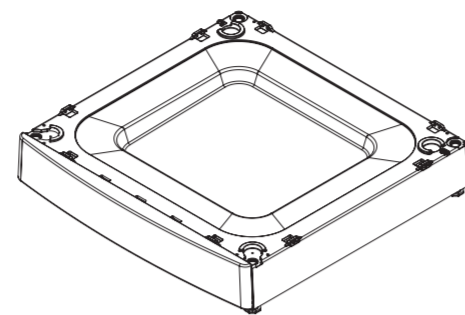

Included Accessories



- 1 Bracket (for Dryer) : 4 EA
- 2 M 4 X 20 Screws : 18 EA

Tools Needed



- 1 Wrench
- 2 Screwdriver

Dimensions

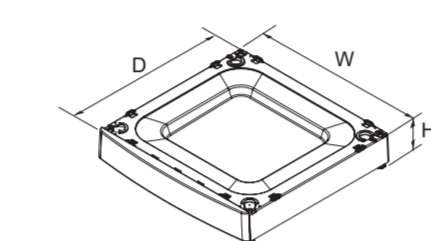

W	27"	690 mm
D	27"	690 mm
H	5 1/8"	130 mm

WARRANTY

LG Electronics Inc., will repair or at its option replace, without charge, your product if it proves to be defective in material or workmanship under normal use during the warranty period set forth below, effective from the date of original consumer purchase of the product. This limited warranty is good only to the original purchaser of the product and effective only when used in the United States including Alaska, Hawaii, and U.S. Territories; and Canada.

WARRANTY PERIOD	HOW SERVICE IS HANDLED
1 Year from the Date of Purchase	Call 1-800-243-0000 (USA) or 1-888-542-2623 (CANADA) and choose the appropriate prompt. Please have product type, model number, serial number, and ZIP code ready.

THIS WARRANTY IS IN LIEU OF ANY OTHER WARRANTIES, EXPRESS OR IMPLIED, INCLUDING WITHOUT LIMITATION, ANY WARRANTY OF MERCHANTABILITY OR FITNESS FOR A PARTICULAR PURPOSE. TO THE EXTENT ANY IMPLIED WARRANTY IS REQUIRED BY LAW, IT IS LIMITED IN DURATION TO THE EXPRESS WARRANTY PERIOD ABOVE. LG WILL NOT BE LIABLE FOR ANY CONSEQUENTIAL, INDIRECT, OR INCIDENTAL DAMAGES OF ANY KIND, INCLUDING LOST REVENUE OR PROFITS, IN CONNECTION WITH THE PRODUCT.

SOME STATES DO NOT ALLOW LIMITATION ON HOW LONG AN IMPLIED WARRANTY LASTS OR THE EXCLUSION OF INCIDENTAL OR CONSEQUENTIAL DAMAGES, SO THE ABOVE LIMITATIONS OR EXCLUSIONS MAY NOT APPLY TO YOU.

THIS LIMITED WARRANTY DOES NOT APPLY TO:

1. Service trips to your home to deliver, pick up, and/or install the product, instruct, or replace house fuses or correct wiring, or correction of unauthorized repairs; and
2. Damages or operating problems that result from misuse, abuse, operation outside environmental specifications or contrary to the requirements or precautions in the Operating Guide, accident, vermin, fire, flood, improper installation, acts of God, unauthorized modification or alteration, incorrect electrical current or voltage, or commercial use, or use for other than intended purpose.
3. Therefore, the cost of repair or replacement of such a defective product shall be borne by the consumer.

CUSTOMER INFORMATION CENTER NUMBERS

To Prove Warranty Coverage	Retain your Sales Receipt to prove date of purchase. A copy of your Sales Receipt must be submitted at the time warranty service is provided.
To Obtain Nearest Authorized Service Center or Sales Dealer, or to Obtain Product, Customer, or Service Assistance	Call 1-800-243-0000 or 1-888-542-2623 (CANADA) and choose the appropriate prompt from the menu, and have your product type, model number, serial number, and ZIP Code; or visit our website at <a href="http://www.lgservice.com">http://www.lgservice.com</a>

Stacking Pedestal

Before Installation

- If the washer or combo was previously installed, unplug it, disconnect the inlet hose(s) from the faucet(s), disconnect the drain hose, and drain all hoses.
- If dryer was previously installed, uninstall it as follows:
  - Uninstalling an electric dryer:
    - 1) Unplug the power supply cord.
    - 2) Pull the dryer away from the wall enough to loosen the vent clamp. Loosen the clamp and carefully remove the exhaust vent from the dryer exhaust outlet.
  - Uninstalling a gas dryer:
    - 1) Unplug the power supply cord,
    - 2) Turn off the gas supply.
    - 3) Pull the dryer away from the wall enough to loosen the vent clamp. Loosen the clamp and carefully remove the exhaust vent from the dryer exhaust outlet.

How to Stack

- 1 Check the fastening structure at the bottom of the side of the product. Go to Step 2 for dryer and Step 4 for washer.

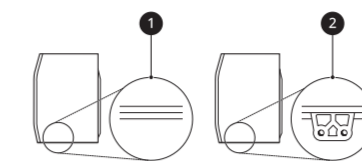

- 2 Tilt and hold product.

- 3 Insert the T-clip 1 of the bracket 2 into the dryer base as shown. Press up on the back of the clip and pull outward to lock into place.

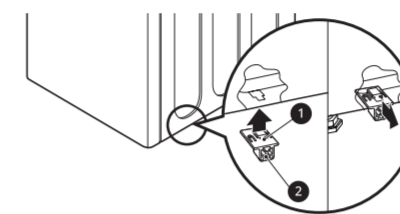

- 4 Place the product on top of the pedestal.
  - Make sure the 4 legs are totally locked and the holes in the pedestal align with the holes in the washing machine.

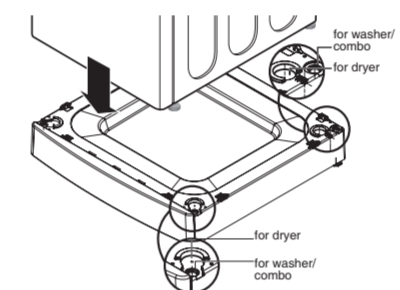

- 5 Securely attach the two products at the corners using screws.
  - First, insert screws on each side. Then insert screws on the front and back side.
  - Tighten screws to assemble the stacking brackets.

- For washer: 16 screws

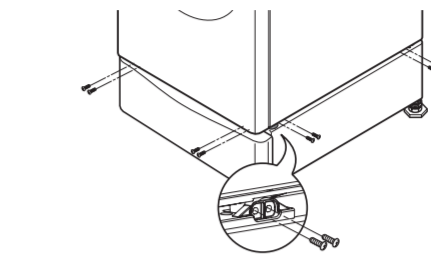

- For dryer: 8 screws

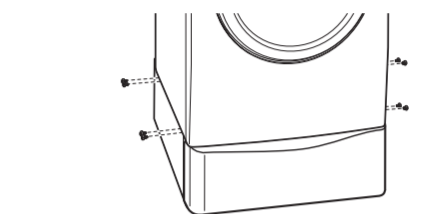

- 6 Extend all 4 feet 1 of the washing machine slightly until it is snugged up against the pedestal. Then tighten the four lock nuts 2.

- 7 Turn all 4 leveling feet 1 in one direction to raise the pedestal or the other direction to lower it. Then tighten the locknuts 2.

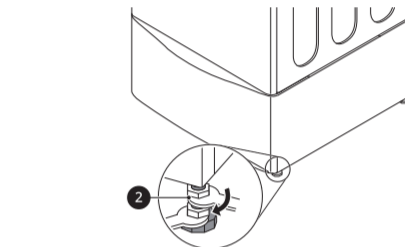
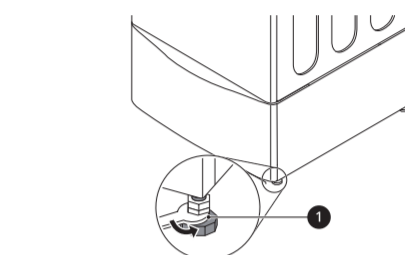

Memo



INSTRUCCIONES DE INSTALACIÓN

PEDESTAL



Antes de comenzar con la instalación, lea atentamente estas instrucciones. Esto simplificará el trabajo y garantizará que el producto esté instalado de manera correcta y segura. Después de la instalación, deje estas instrucciones cerca del producto para futuras consultas.

ESPAÑOL

WDPS1\*

**LEA TODAS LAS INSTRUCCIONES ANTES DE UTILIZAR**

La finalidad de las siguientes pautas de seguridad es impedir riesgos o daños imprevistos causados por el funcionamiento inseguro o incorrecto del artefacto.

Las pautas se dividen en mensajes de "ADVERTENCIA" y "PRECAUCIÓN", como se describe a continuación.

**Mensajes de seguridad**

**⚠** Este símbolo se muestra para indicar asuntos y operaciones que pueden causar riesgos. Lea el texto marcado con este símbolo atentamente y siga las instrucciones para evitar riesgos.

**⚠ ADVERTENCIA**

Esto indica que si no sigue las instrucciones se pueden causar lesiones graves o la muerte.

**⚠ PRECAUCIÓN**

Esto indica que si no sigue las instrucciones se pueden causar lesiones leves o dañar el producto.

**ADVERTENCIA**

**⚠ ADVERTENCIA**

**Para disminuir el riesgo de explosiones, incendios, la muerte, descargas eléctricas, lesiones o quemaduras las personas que usen este producto, siga las precauciones básicas, incluidas las siguientes:**

- Este artefacto solo debe instalarse y transportarse entre dos o más personas para elevar el pedestal de forma segura.
- Desenchufe la lavadora de carga frontal o la secadora antes de apilarla sobre el pedestal.
- Mantenga los materiales y vapores inflamables, tales como la gasolina, alejados de la secadora.
- Coloque la secadora a un mínimo de 46cm (18 pulg.) sobre el piso para la instalación en un garaje.

**Partes y dimensiones**

Las ilustraciones en esta guía pueden diferir de los componentes y accesorios reales, los cuales están sujetos a cambios sin previo aviso por parte del fabricante a fin de introducir mejoras en el producto.

**Vista frontal**

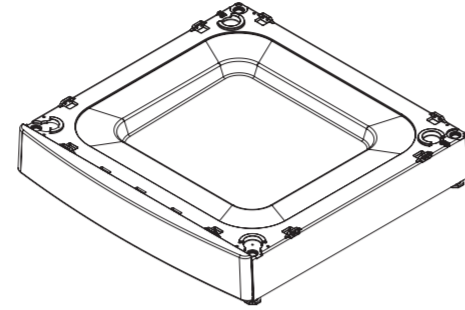

**Accesorios incluidos**

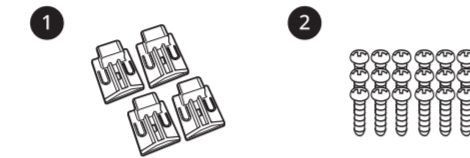

- 1 Soporte (para secadora): 4 EA
- 2 20 tornillos M 4: 18 EA

**Dimensiones**

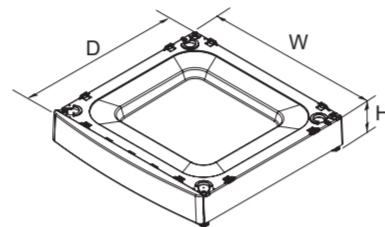

W	27"	690 mm
D	27"	690 mm
H	5 1/8"	130 mm

**Herramientas necesarias**



- 1 Llave
- 2 Destornillador

**Pedestal para apilado**

**Antes de la instalación**

- Si la lavadora o el combo se instaló previamente, desenchufe, desconecte las mangueras de entrada de los grifos, desconecte la manguera de drenaje y drene todas las mangueras.
- Si la secadora se instaló previamente, desinstálela de la siguiente manera:
  - Desinstalación de una secadora eléctrica:
    - 1) Desconecte el cable de alimentación.
    - 2) Separe la secadora de la pared lo suficiente como para aflojar la abrazadera de ventilación. Afloje la abrazadera y retire con cuidado el conducto de ventilación de escape de la salida de escape de la secadora.
  - Desinstalación de una secadora a gas:
    - 1) Desconecte el cable de alimentación.
    - 2) Corte el suministro de gas.
    - 3) Separe la secadora de la pared lo suficiente como para aflojar la abrazadera de ventilación. Afloje la abrazadera y retire con cuidado el conducto de ventilación de escape de la salida de escape de la secadora.

**Cómo apilar**

- 1 Compruebe la estructura de sujeción en la parte inferior en el costado del producto. Vaya al Paso 2 para la secadora y al Paso 4 para la lavadora.

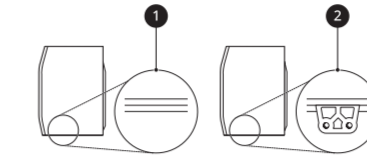

- 2 Incline y sostenga el producto.

- 3 Inserte la pinza en T 1 del soporte 2 en la base de la secadora, como se muestra en la imagen. Presione hacia arriba en la parte posterior de la pinza y tire hacia afuera para trabar en el lugar.

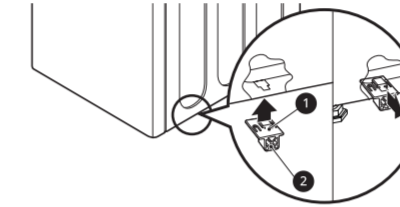

- 4 Ubique el producto sobre el pedestal.
  - Asegúrese de que las 4 patas estén totalmente bloqueadas y que los orificios en el pedestal estén alineados con los orificios de la lavadora.

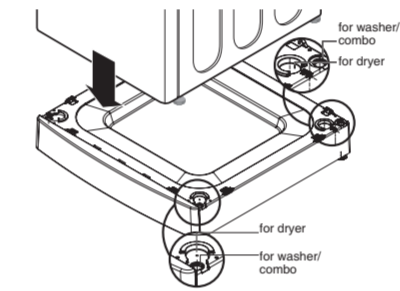

INSTALLATION INSTRUCTIONS

**PEDESTAL**



Before beginning installation, read these instructions carefully. This will simplify installation and ensure that the product is installed correctly and safely. Leave these instructions near the product after installation for future reference.

ENGLISH

ESPAÑOL

WDPS1\*



MFL67454005  
Rev.01\_122120

www.lg.com  
Copyright © 2020 LG Electronics Inc. All Rights Reserved

- 5 Una los dos productos en las esquinas con los tornillos de forma segura.
  - Primero, introduzca los tornillos en cada lado. Luego, introduzca los tornillos en el lado frontal y lateral.
  - Apriete los tornillos para ensamblar los soportes de apilado.

- Para la lavadora: 16 tornillos

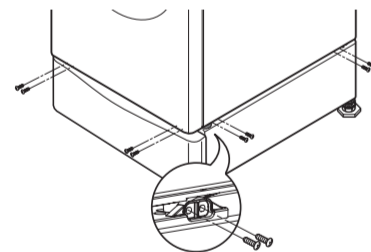

- Para la secadora: 8 tornillos

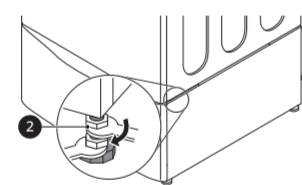
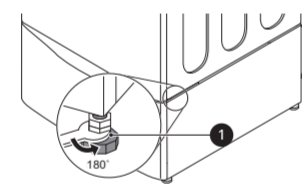
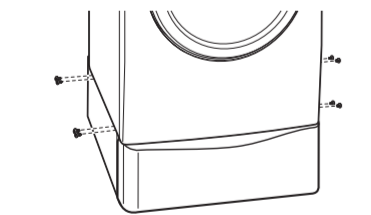

- 7 Gire las 4 patas de nivelación 1 en una dirección para elevar el pedestal o en la dirección contraria para bajarlo. Luego apriete las tuercas de seguridad 2.

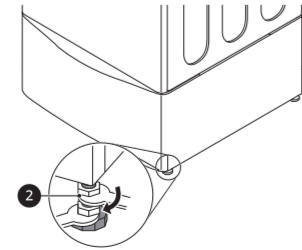
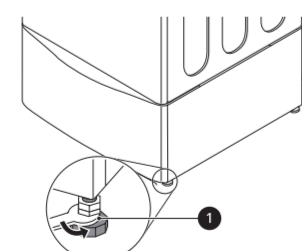

- 6 Extienda los 4 pies 1 de la lavadora ligeramente hasta ajustar hacia arriba contra el pedestal. Luego apriete las cuatro tuercas de seguridad 2.

**⚠ PRECAUCIÓN**

- No instale un pedestal de secadora entre una lavadora y una secadora apiladas.

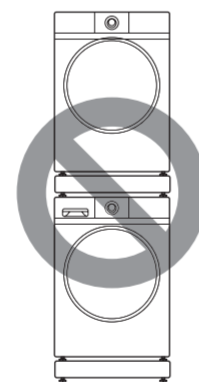

**GARANTÍA**

LG Electronics Inc., reparará o reemplazará el producto, a su discreción, sin cargo, si se comprueba que el material o la fabricación tienen defectos en condiciones de uso normales durante el período de garantía establecido a continuación, con vigencia desde la fecha de compra original del producto por parte del consumidor. Esta garantía limitada es válida solo para el comprador original del producto y si se utiliza únicamente dentro de los Estados Unidos, incluyendo Alaska, Hawái y territorios de EE. UU. y Canadá.

PERÍODO DE GARANTÍA	CÓMO SE MANEJA EL SERVICIO TÉCNICO
1 año desde la Fecha de compra	Llame al 1-800-243-0000 (EE. UU.) o 1-888-542-2623 (CANADÁ) y elija la opción deseada. Tenga cerca el tipo de producto, número de modelo, número de serie y código postal.

ESTA GARANTÍA REEMPLAZA CUALQUIER OTRA GARANTÍA, EXPRESA O IMPLÍCITA, LO QUE INCLUYE SIN LÍMITE, LAS GARANTÍAS DE APTITUD COMERCIAL O IDONEIDAD PARA UN FIN EN PARTICULAR. SALVO POR LAS GARANTÍAS IMPLÍCITAS EXIGIDAS POR LA LEY, SU DURACIÓN ESTÁ LIMITADA AL PERÍODO DE GARANTÍA EXPRESO MENCIONADO ANTERIORMENTE. LG NO SERÁ RESPONSABLE DE NINGÚN DAÑO EMERGENTE, INDIRECTO O INCIDENTAL DE NINGÚN TIPO, LO QUE INCLUYE INGRESOS O GANANCIAS PERDIDOS EN RELACIÓN CON EL PRODUCTO. ALGUNOS ESTADOS NO PERMITEN LIMITACIONES RESPECTO DE LA DURACIÓN DE UNA GARANTÍA IMPLÍCITA O LA EXCLUSIÓN DE DAÑOS INCIDENTALES O EMERGENTES, DE MANERA QUE LAS LIMITACIONES O LAS EXCLUSIONES ANTERIORES PUEDEN NO APLICAR PARA USTED.

**ESTA GARANTÍA LIMITADA NO SE APLICA A LO SIGUIENTE:**

1. Traslados de servicio a su hogar para entregar, recoger o instalar el producto, brindar instrucciones o reemplazar los fusibles de la casa, corregir cableados o reparaciones no autorizadas; y
2. Daños o problemas de funcionamiento causados por mal uso, abuso, funcionamiento fuera de las especificaciones ambientales o contrario a los requerimientos o precauciones mencionados en la Guía de funcionamiento; accidentes, pestes, incendios, inundaciones, instalación inadecuada, hechos de fuerza mayor, modificaciones o alteraciones no autorizadas, corriente o tensión eléctrica incorrecta, uso comercial, o uso para otro fin que no sea el previsto.
3. Por lo tanto, el costo de la reparación o el reemplazo de ese producto defectuoso correrá por cuenta del cliente.

**NÚMEROS DEL CENTRO DE INFORMACIÓN AL CLIENTE**

Para comprobar la Cobertura de la garantía	Conservar los Recibos de compra para comprobar la fecha de compra. Debe presentar una copia del Recibo de compra al recibir el servicio de garantía.
Para contactar al Centro de Servicio Autorizado o al Distribuidor de Ventas más cercano, o para recibir Asistencia con el Producto, Cliente o Reparación.	Llame al 1-800-243-0000 o 1-888-542-2623 (CANADÁ) y elija la opción deseada del menú. Tenga cerca el tipo de producto, número de modelo, número de serie y código; o visite nuestro sitio Web en: <a href="http://www.lgservice.com">http://www.lgservice.com</a>



# OWNER'S MANUAL

# DRYER

---

Read this owner's manual thoroughly before operating the appliance and keep it handy for reference at all times.

ENGLISH    ESPAÑOL

DLE3600\*, DLG3601\*  
DLEX4000\*, DLGX4001\*  
DLEX4200\*, DLGX4201\*  
DLEX4500\*, DLGX4501\*



MFL70442647  
Rev.03\_070620

[www.lg.com](http://www.lg.com)

Copyright © 2020 LG Electronics Inc. All Rights Reserved.

# TABLE OF CONTENTS

## **3 PRODUCT FEATURES**

---

## **4 SAFETY INSTRUCTIONS**

---

5 IMPORTANT SAFETY INSTRUCTIONS

## **9 PRODUCT OVERVIEW**

---

9 Parts

9 Accessories

## **10 INSTALLATION**

---

10 Installation Overview

10 Product Specifications

11 Installation Location Requirements

12 Clearances

14 Leveling the Dryer

15 Reversing the Door

16 Installing the Side Vent Kit

17 Stacking the Dryer

18 Venting the Dryer

20 Connecting the Inlet Hose  
(Steam Models)

21 Connecting Gas Dryers

23 Connecting Electric Dryers

28 Special Electrical Requirements

28 Final Installation Check

29 Installation Test (Duct Check)

## **31 OPERATION**

---

31 Using the Dryer

32 Check the Lint Filter Before Every Load

32 Sorting Laundry

32 Loading the Dryer

33 Control Panel

36 Cycle Guide

40 Cycle Modifier Buttons

40 Option Buttons

41 Special Functions

41 Steam Functions  
(Steam Models)

## **44 SMART FUNCTIONS**

---

44 LG ThinQ Application

47 Smart Diagnosis™ Function

## **48 MAINTENANCE**

---

48 Regular Cleaning

## **49 TROUBLESHOOTING**

---

49 FAQs: Frequently Asked Questions

49 User Support Videos

50 Before Calling for Service

## **56 WARRANTY**

---



# PRODUCT FEATURES

## Easy-to-Use Control Panel

Rotate the cycle selector knob to select the desired dry cycle. Add cycle options or adjust settings with the touch of a button.

## Easy-Access Reversible Door

The wide-opening door provides easy access for loading and unloading. The door hinge can be reversed to adjust for installation location.

## Steam Functions (Steam Models)

LG's steam technology allows you to inject fabrics with a swirling jet of hot steam to refresh clothes, reduce static, and make ironing easier. Simply select the Steam Fresh™ cycle, or you can add a Steam option to selected cycles.

## Flow Sense™ Duct Blockage Sensing System Indicator

The Flow Sense™ duct blockage sensing system detects and alerts you to restrictions in the installed household ductwork that reduce exhaust airflow through the dryer. If you see the alert: Clean or repair the ducts to remove the restrictions. Keep your ducts clean to help increase efficiency and reduce long drying times caused by blocked ducts.

## Smart Diagnosis™

Should you experience any technical difficulty with your dryer, it has the capability of transmitting data via your telephone to the Customer Information Center. The call center agent records the data transmitted from your machine and uses it to analyze the issue, providing a fast and effective diagnosis.

## LG ThinQ

Download the new LG smart phone app to set options, self-diagnose and troubleshoot problems with the appliance, and other useful features. This function uses Wi-Fi.



# SAFETY INSTRUCTIONS

## READ ALL INSTRUCTIONS BEFORE USE

### Your safety and the safety of others are very important.

We have provided many important safety messages in this manual and on your appliance. Always read and follow all safety messages.

This is the safety alert symbol.



This symbol alerts you to potential hazards that can kill or injure you and others.

All safety messages will follow the safety alert symbol and either the word WARNING or CAUTION.

These words mean:



### WARNING

You may be killed or seriously injured if you do not follow instructions.



### CAUTION

You may be slightly injured or cause damage to the product if you do not follow instructions.

All safety messages will tell you what the potential hazard is, tell you how to reduce the chance of injury, and tell you what may happen if the instructions are not followed.

## **WARNING- Risk of Fire**

Install the clothes dryer according to the manufacturer's instructions and local codes.

- Clothes dryer installation must be performed by a qualified installer.
- Do not install a clothes dryer with flexible plastic venting materials. If flexible metal (foil type) duct is installed, it must be of a specific type identified by the appliance manufacturer as suitable for use with clothes dryers. Flexible venting materials are known to collapse, be easily crushed, and trap lint. These conditions will obstruct clothes dryer airflow and increase the risk of fire.
- To reduce the risk of severe injury or death, follow all installation instructions.
- Save these instructions.



### WARNING

#### FIRE OR EXPLOSION HAZARD

Failure to follow safety warnings exactly could result in serious injury, death or property damage.

- Do not store or use gasoline or other flammable vapors and liquids in the vicinity of this or any other appliance.
- WHAT TO DO IF YOU SMELL GAS
  - Do not try to light any appliance.
  - Do not touch any electrical switch; do not use any phone in your building.
  - Clear the room, building or area of all occupants.
  - Immediately call your gas supplier from a neighbor's phone. Follow the gas supplier's instructions.
  - If you cannot reach your gas supplier, call the fire department.
- Installation and service must be performed by a qualified installer, service agency or your gas supplier.

## IMPORTANT SAFETY INSTRUCTIONS

### WARNING

**To reduce the risk of explosion, fire, death, electric shock, scalding or injury to persons when using this product, follow basic precautions, including the following:**

#### INSTALLATION

- Before use, the appliance must be properly installed as described in this manual.
- Connect to a properly rated, protected, and sized power circuit to avoid electrical overload.
- To reduce the risk of severe injury or death, follow all installation instructions.
- The appliance must be installed and electrically grounded by qualified service personnel in accordance with local codes.
- Disconnect the power cord, house fuse or circuit breaker before installing or servicing the appliance.
- When moving or installing the product in a different location, call qualified service personnel for installation and service.
- Keep packing materials out of the reach of children. Packaging material can be dangerous for children. There is a risk of suffocation.
- Moving or installation of the appliance requires two or more people.
- This appliance is not designed for maritime use or for mobile installations such as in RVs, trailers, or aircraft.
- Store and install the appliance where it will not be exposed to temperatures below freezing or exposed to outdoor weather conditions.
- This appliance must be positioned near to an electrical power supply.
- Do not, under any circumstances, cut or remove the third (ground) prong from the power cord.
- When installing or moving the appliance, be careful not to pinch, crush, or damage the power cord.
- Do not install the appliance in humid spaces.
- Destroy the carton, plastic bag, and other packing materials after the appliance is unpacked. Children might use them for play. Cartons covered with rugs, bedspreads, or plastic sheets can become airtight chambers.
- Adhere to all industry recommended safety procedures including the use of long sleeved gloves and safety glasses.
- Never attempt to operate this appliance if it is damaged, malfunctioning, partially disassembled, or has missing or broken parts, including a damaged cord or plug.
- Do not install a clothes dryer with flexible plastic venting materials. If flexible metal (foil type) duct is installed, it must be of a specific type identified by the appliance manufacturer as suitable for use with clothes dryers. Flexible venting materials are known to collapse, be easily crushed, and trap lint. These conditions will obstruct clothes dryer airflow and increase the risk of fire.

- Place the dryer at least 18 inches above the floor for a garage installation.
- Do not use sheet metal screws or other fasteners which extend into the duct that could catch lint and reduce the efficiency of the exhaust system. Secure all joints with duct tape.
- Use only rigid, semi-rigid or flexible metal 4-inch diameter duct inside the dryer cabinet or for exhausting to the outside. Use of plastic or other combustible ductwork may cause a fire. Punctured ductwork may cause a fire if it collapses or becomes otherwise restricted in use or during installation.
- The exhaust duct must be 4 inches (10.2 cm) in diameter with no obstructions. The exhaust duct should be kept as short as possible. Make sure to clean any old ducts before installing your new dryer.
- Rigid, semi-rigid or flexible metal ducting is recommended for use between the dryer and the wall. All non-rigid metal transition duct must be UL-listed. Use of other materials for transition duct could affect drying time.
- Ductwork is not provided with the dryer, and you should obtain the necessary ductwork locally. The end cap should have hinged dampers to prevent backdraft when the dryer is not in use.
- Gas dryers **MUST** be exhausted to the outside.
- The dryer exhaust system must be exhausted to the outside of the dwelling. If the dryer is not exhausted outdoors, some fine lint and large amounts of moisture will be expelled into the laundry area. An accumulation of lint in any area of the home may create a health and fire hazard.
- Do not install near another heat source such as a stove, oven or heater.
- Keep area around the exhaust opening and adjacent surrounding areas free from the accumulation of lint, dust, and dirt.
- The appliance must not be supplied through an external switching device, such as a timer, or connected to a circuit that is regularly switched on and off by a utility.

## **OPERATION**

- Repair or immediately replace all power cords that have become frayed or otherwise damaged. Do not use a cord that shows cracks or abrasion damage along its length or at either end.
- If you detect a strange sound, a chemical or burning smell, or smoke coming from the appliance, unplug it immediately, and contact an LG Electronics customer information center.
- Never unplug the appliance by pulling on the power cord. Always grip the plug firmly and pull straight out from the outlet.
- Do not use an extension cord or adapter with this appliance.
- Do not grasp the power cord or touch the appliance controls with wet hands.
- Do not modify or extend the power cord.
- If the product has been submerged, contact an LG Electronics customer information center for instructions before resuming use.
- Do not store or use gasoline or other flammable vapors and liquids in the vicinity of this or any other appliance.
- Keep the area underneath and around your appliances free of combustible materials (lint, paper, rags, etc.), gasoline, chemicals and other flammable vapors and liquids.
- This appliance is not intended for use by persons (including children) with reduced physical, sensory or mental capabilities, or lack of experience and knowledge, unless they have been given supervision or instruction concerning the use of the appliance by a person responsible for their safety.



- Read all instructions before using the appliance and save these instructions.
- Use this appliance only for its intended purpose.
- Do not abuse, sit on, or stand on the door of the appliance.
- Do not allow children to play on, in or with the appliance. Close supervision of children is necessary when the appliance is used near children.
- Do not tamper with controls.
- In the event of a gas leak (propane gas, LP gas, etc.) do not operate this or any other appliance. Open a window or door to ventilate the area immediately.
- Under certain conditions, hydrogen gas may be produced in a hot-water system that has not been used for two weeks or more. **HYDROGEN GAS IS EXPLOSIVE.** If the hot-water system has not been used for such a period, before using the appliance turn on all hot water faucets and let the water flow from each for several minutes. This will release any accumulated hydrogen gas. As the gas is flammable, do not smoke or use an open flame during this time.
- Fix the drain hose securely in place.
- Do not put oily or greasy clothing, candles or flammable materials on top of the appliance.
- Do not use fabric softeners or products to eliminate static unless recommended by the manufacturer of the fabric softener or product.
- Do not reach into the appliance if the drum is moving.
- Do not dry articles that have been previously cleaned in, washed in, soaked in, soiled with or spotted with gasoline, dry cleaning solvents, vegetable oil, cooking oil or other flammable or explosive substances, as they give off vapors that could ignite or explode.
- Do not use heat to dry articles containing foam rubber or similarly textured rubber-like materials.
- Do not store plastic, paper, or clothing that may burn or melt on top of the dryer during operation.
- Always check the inside of the appliance for foreign objects.
- Gas appliances can cause minor exposure to four potentially hazardous substances, namely benzene, carbon monoxide, formaldehyde, and soot, caused primarily by the incomplete combustion of natural gas or LP fuels.
- Properly adjusted dryers will minimize incomplete combustion. Exposure to these substances can be minimized further by properly venting the dryer to the outdoors.
- Do not place items exposed to cooking oils in your dryer. Items contaminated with cooking oils may contribute to a chemical reaction that could cause a load to catch fire.  
To reduce the risk of fire due to contaminated loads, the final part of a tumble dryer cycle occurs without heat (cool down period). Avoid stopping a tumble dryer before the end of the drying cycle unless all items are quickly removed and spread out so that the heat is dissipated.
- Do not let children or pets climb inside the dryer drum.
- Do not put living animals such as pets inside the product.
- Do not put any part of your body, such as your hands or feet, or metal objects under the product.
- Do not let your hand get pinched when opening or closing the dryer door.

### **STEAM (Steam Models)**

- Do not open the dryer door during steam cycles.
- Do not touch the steam nozzle in the drum during or after a steam cycle.

## MAINTENANCE

- Do not repair or replace any part of the appliance. All repairs and servicing must be performed by qualified service personnel unless specifically recommended in this Owner's Manual. Use only authorized factory parts.
- Do not disassemble or repair the appliance by yourself.
- Remove any dust or foreign matter from the power plug pins.
- Disconnect this appliance from the power supply before cleaning and attempting any user maintenance. Turning the controls to the OFF position does not disconnect this appliance from the power supply.
- Remove the door before the appliance is removed from service or discarded to avoid the danger of children or small animals getting trapped inside.
- Unplug the appliance before cleaning to avoid the risk of electric shock.
- Clean the lint filter before or after each load.
- The interior of the appliance and exhaust duct should be cleaned periodically by qualified service personnel.

## GROUNDING INSTRUCTIONS

- Improper connection of the equipment-grounding conductor can result in a risk of electric shock. Check with a qualified electrician or service personnel if you are in doubt whether the appliance is properly grounded. Do not modify the plug provided with the appliance; if it will not fit the outlet, have a proper outlet installed by a qualified electrician.
- The appliance must be grounded. In the event of a malfunction or breakdown, grounding will reduce the risk of electric shock by providing a path of least resistance for electric current. The appliance is equipped with a cord having an equipment-grounding conductor and a grounding plug. The plug must be plugged into an appropriate outlet that is installed and grounded in accordance with all local codes and ordinances.
- This dryer must be plugged into a properly grounded outlet. Electrical shock may result if the dryer is not properly grounded. Have the wall outlet and circuit checked by a qualified electrician to make sure the outlet is properly grounded. Failure to follow these instructions may create an electric shock hazard and/or a fire hazard.

## WARNING

### Fire Hazard

**Failure to follow safety warnings exactly could result in serious injury, death or property damage.**

- Do not install a booster fan in the exhaust duct.
- Install all clothes dryers in accordance with the installation instructions of the manufacturer of the dryer.

# SAVE THESE INSTRUCTIONS

# PRODUCT OVERVIEW

## Parts

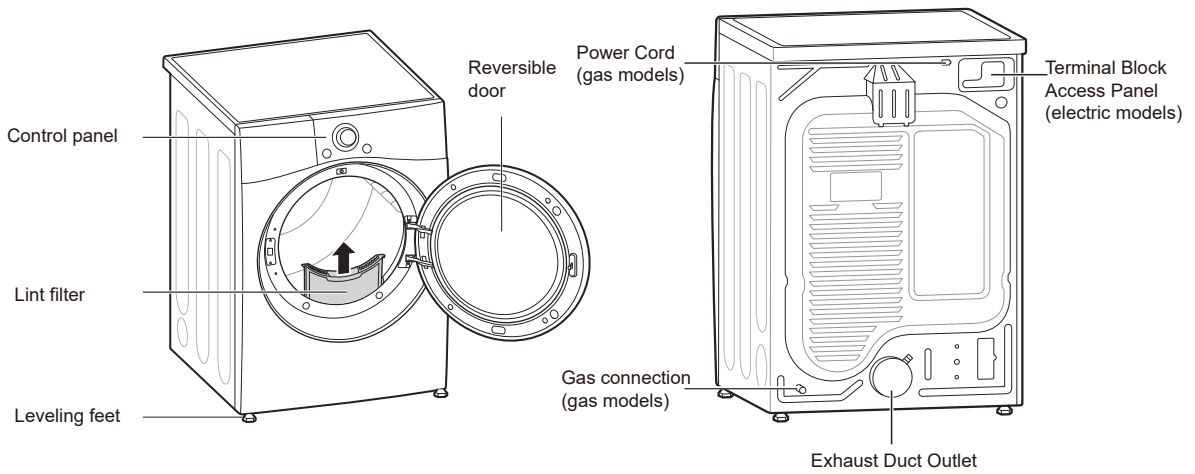

## Accessories

### Included Accessories



Y connector  
(Steam Models)

### Optional Accessories

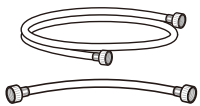

Hoses  
(Steam Models)

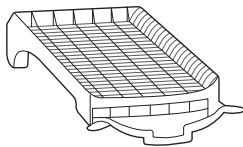

Drying Rack  
(sold separately)

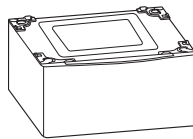

Pedestal  
(sold separately)



Stacking kit  
(sold separately)

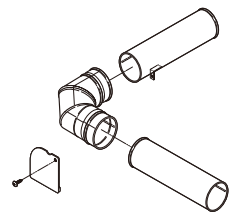

Side vent kit  
(sold separately)  
Kit No. 383EEL9001B

### NOTE

- For your safety and extended product life, use only authorized components. The manufacturer is not responsible for product malfunction or accidents caused by the use of unauthorized components or parts.
- The images in this manual may be different from the actual components and accessories which are subject to change by the manufacturer without prior notice for product improvement purposes.

# INSTALLATION

## Installation Overview

Please read the following installation instructions first after purchasing this product or transporting it to another location.

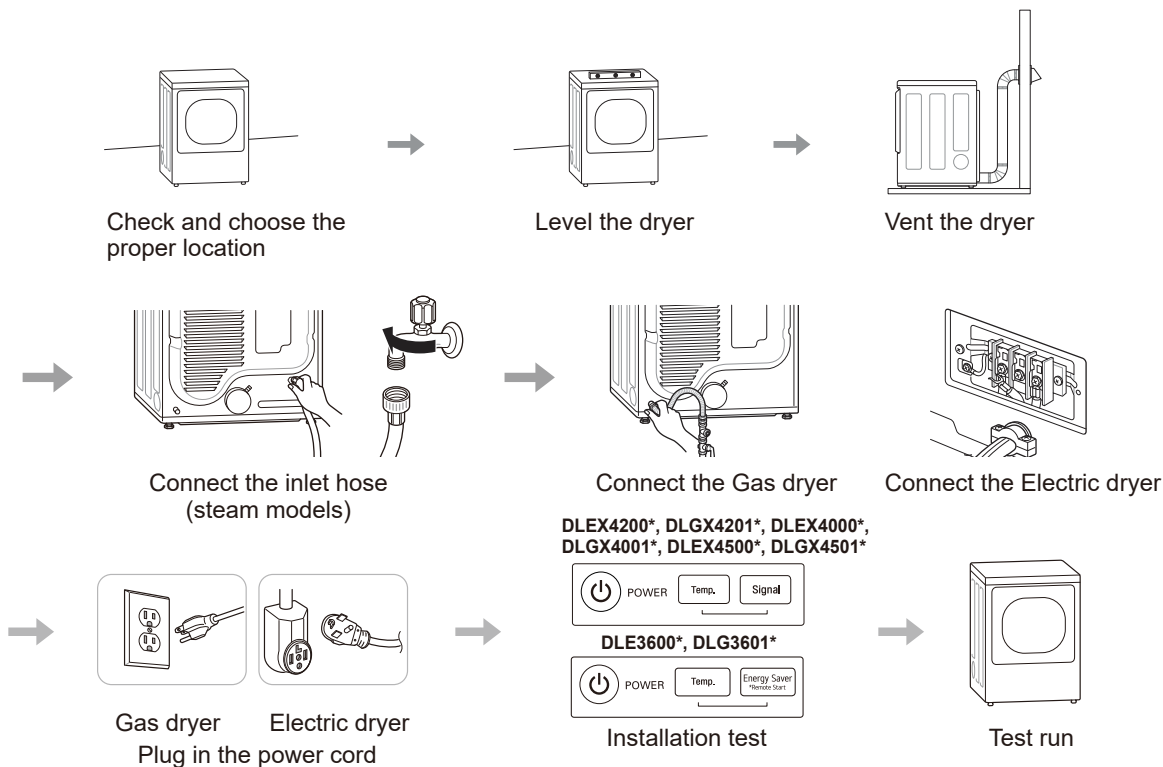

## Product Specifications

The appearance and specifications listed in this manual may vary due to constant product improvements.

Dryer Models		DLE3600*, DLG3601*	DLEX4000*, DLGX4001*	DLEX4200*, DLGX4201*	DLEX4500*, DLGX4501*
Description		Non-steam Dryer	Steam Dryer	Steam Dryer	
Electrical requirements		Please refer to the rating label for detailed information.			
Gas requirements		NG: 4 - 10.5-inch (10.2 - 26.7 cm) WC LP: 8 - 13-inch (20.4 - 33.1 cm) WC			
Dimensions		27" (W) X 30 1/8" (D) X 39" (H), 51 3/8" (D with door open) 68.6 cm (W) X 76.5 cm (D) X 99 cm (H), 130.5 cm (D with door open)		27" (W) X 30" (D) X 39" (H), 51" (D with door open) 68.6 cm (W) X 76.1 cm (D) X 99 cm (H), 129.7 cm (D with door open)	
Net weight		Gas : 136.03 lb (61.7kg) - 139.34 lb (63.2kg) Electric : 121.9 lb (55.3kg) - 125.3 lb (56.8kg)		Gas : 140.4 lb (63.7 kg) Electric : 133.4 lb (60.5 kg)	
Drying capacity	Steam Cycle	-	IEC 7.4 cu.ft. (8 lb/3.6 kg)		
	Normal Cycle	IEC 7.4 cu.ft. (22.5 lb/10.2 kg)			

**NOTE**

Model numbers can be found on the cabinet inside the door.



## Installation Location Requirements

### WARNING

- Read all installation instructions completely before installing and operating your dryer. It is important that you review this entire manual before installing and using your dryer. Detailed instructions concerning electrical connections, gas connections, and exhaust requirements are provided on the following pages.

### WARNING

**To reduce the risk of serious injury or death, follow basic precautions, including the following:**

- Use long-sleeved gloves and safety glasses.
- The appliance is heavy. Two or more people are required when installing the dryer.

The installation requires:

- A location that allows for proper exhaust installation. A gas dryer must be exhausted to the outdoors. See Venting the Dryer.
- A grounded electrical outlet located within 2 ft. (61 cm) of either side of the dryer. See Connecting Electric Dryers.
- A sturdy floor to support the total dryer weight of 200 lb (90.7 kg). The combined weight of a companion appliance should also be considered.
- No other fuel-burning appliance can be installed in the same closet as a dryer.
- Additional clearances might be required for wall, door and floor moldings.
- Companion appliance spacing should also be considered.

### NOTE

- The floor must be level, with a maximum slope of 1 inch (2.5 cm) under the entire dryer. Clothes may not tumble properly, and automatic sensor cycles may not operate correctly if the dryer is not level.
- For garage installation, you will need to place the dryer at least 18 inches (45.7 cm) above the floor. The standard pedestal height is 15 inches (38 cm). You will need 18 inches (45.7 cm) from the garage floor to the bottom of the dryer.
- Do not operate your dryer at temperatures below 45 °F (7 °C). At lower temperatures, the dryer might not shut off at the end of an automatic cycle. This can result in longer drying times.
- The dryer must not be installed or stored in an area where it will be exposed to water and/or weather.
- Check code requirements that limit, or do not permit, installation of the dryer in garages, closets, mobile homes or sleeping quarters. Contact your local building inspector.

## Clearances

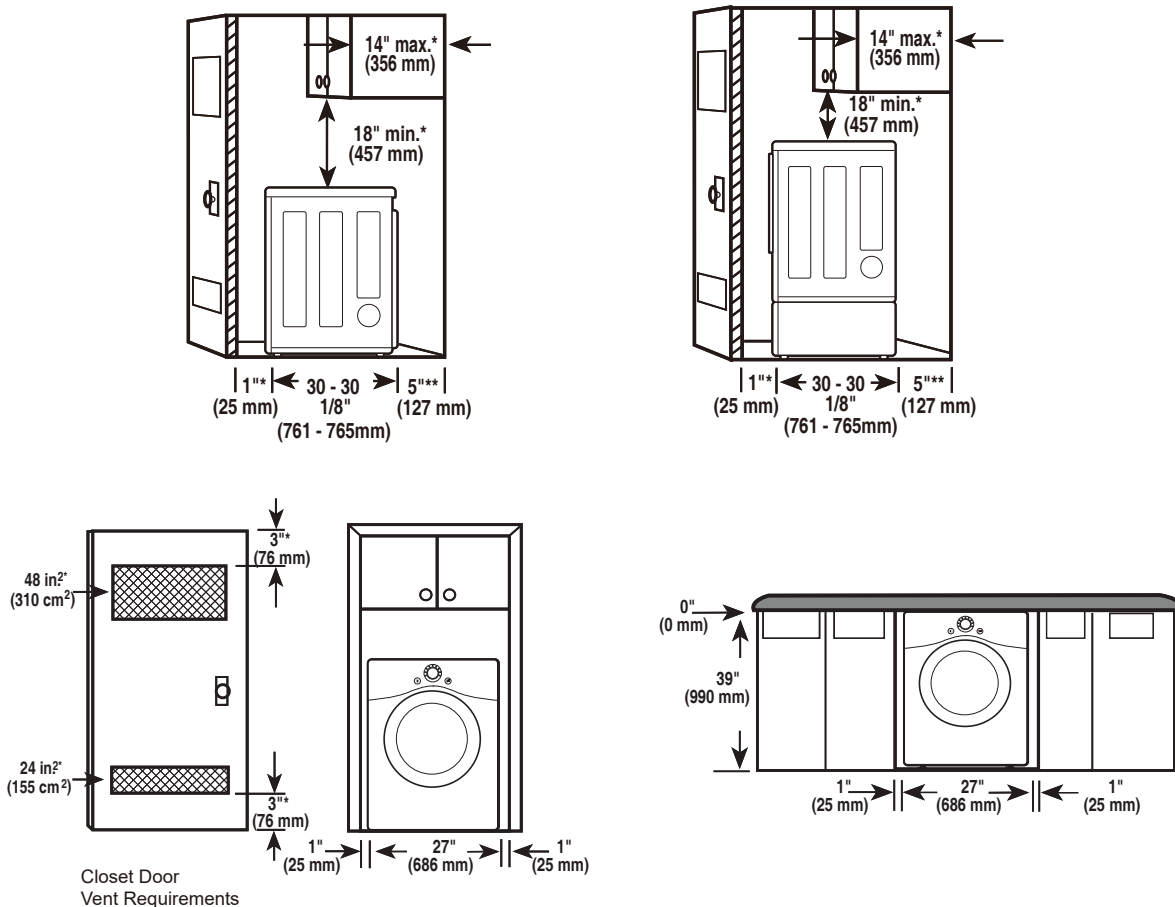

## Installation Spacing for Recessed Area or Closet Installation

The following clearances are recommended for this dryer. This dryer has been tested for clearances of 1 inch (2.5 cm) on the sides and rear. Recommended clearances should be considered for the following reasons:

- Additional clearances should be considered for ease of installation and servicing.
- Additional clearances should be considered on all sides of the dryer to reduce noise transfer. For closet installation, with a door, minimum ventilation openings in the top and bottom of the door are required. Louvered doors with equivalent ventilation openings are acceptable.

### Closet Ventilation Requirements

Closets with doors must have both an upper and lower vent to prevent heat and moisture buildup in the closet. One upper vent opening with a minimum opening of 48 sq. in. (310 cm<sup>2</sup>) must be installed no lower than 6 feet above the floor. One lower vent opening with a minimum opening of 24 sq. in. (155 cm<sup>2</sup>) must be installed no more than one foot above the floor. Install vent grilles in the door or cut down the door at the top and bottom to form openings. Louvered doors with equivalent ventilation openings are also acceptable.

### NOTE

- There should be at least a little space around the dryer (or any other appliance) to eliminate the transfer of vibration from one appliance to another. If there is enough vibration, it could cause appliances to make noise or come into contact, causing paint damage and further increasing noise.

## Installation Spacing for Recessed Area or Closet, with Stacked Washer and Dryer

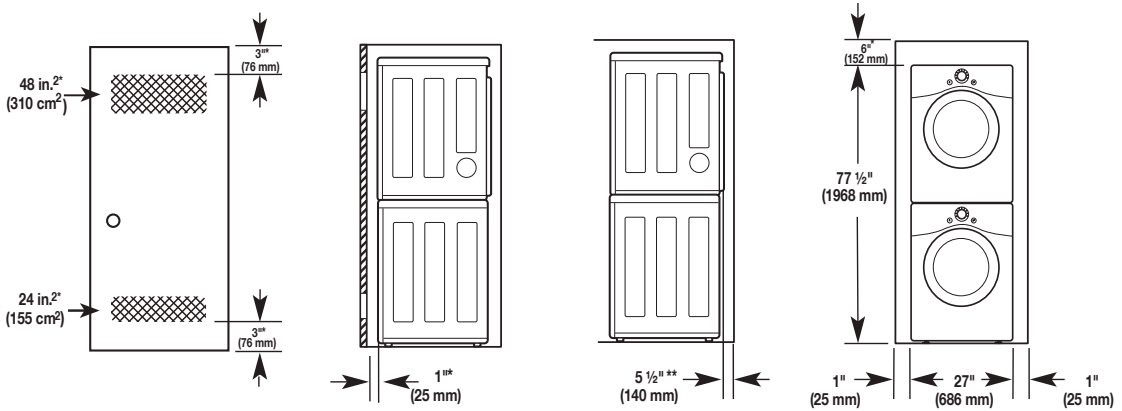

\* Required spacing

\*\* For side or bottom venting, 2-inch (5.1 cm) of spacing is allowed.

## Installation Spacing for Cabinet

For cabinet installation with a door, minimum ventilation openings in the top of the cabinet are required.

\* Required spacing

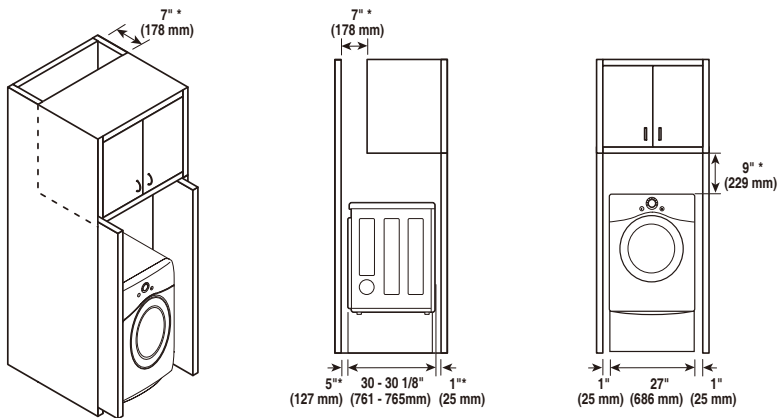

## Leveling the Dryer

### NOTE

- Adjust the leveling feet only as far as necessary to level the dryer. Extending the leveling feet more than necessary may cause the dryer to vibrate.
- To ensure that the dryer provides optimal drying performance, it must be level. To minimize vibration, noise, and unwanted movement, the floor must be a perfectly level, solid surface.

- 1 Position the dryer in the final location. Place a level across the top of the dryer.

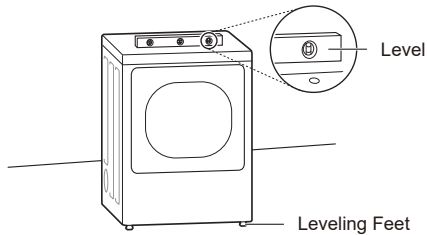

- All four leveling feet must rest solidly on the floor. Gently push on the top corners of the dryer to make sure that the dryer does not rock from corner to corner.

### NOTE

- If you are installing the dryer on the optional pedestal, you must use the leveling feet on the pedestal to level the dryer. The dryer leveling feet should be fully retracted.

- 2 Use an adjustable wrench to turn the leveling feet. Unscrew the legs to raise the dryer or screw in the legs to lower it. Adjust the leveling feet until the dryer is level from side to side and front to back. Make sure that all four leveling feet are in firm contact with the floor.

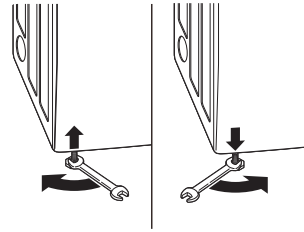



# Reversing the Door

## Tools Required

- Phillips screwdriver
- Large flat blade screwdriver (recommended for hinge screws if they are tight or your Phillips screwdriver is worn)
- Small flat blade screwdriver (for lifting out parts)

### **! WARNING**

To reduce the risk of damage to the dryer, property damage or personal injury, follow basic precautions, including the following:

- Support the door with a stool or box that fits under the door, or have an assistant support the weight of the door.
- Avoid dropping the door.
- Unplug the dryer or turn off power at the main circuit breaker before beginning door reversal.
- Always reverse the door BEFORE stacking the dryer on top of the washer.

## Door Reversal Instructions

The instructions here are for changing the door swing from a right to a left side hinge. If the door has been reversed, and it is necessary to change it back, use care when following these instructions. Some of the illustrations and the left/right references will be reversed, and you will need to read the instructions carefully.

### **! WARNING**

- Be sure to support the weight of the door before removing the hinge screws.

- 1 Open the door and remove the two decorative screws, two latch screws, and the latch on the catch side with a screwdriver. Save these for step 4.

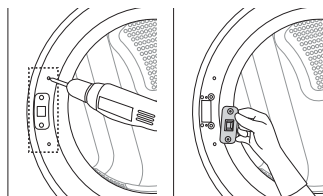

- 2 While supporting the door, remove the 2 screws on the door hinge. Remove the door.

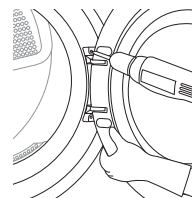

- 3 Turn the door upside down and line up the holes in the hinge with the holes on the opposite side of the cabinet. Reinstall the door with the screws removed in step 2.

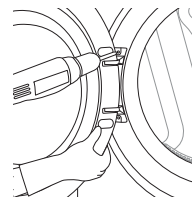

### **! WARNING**

- Be sure to support the weight of the door before installing the hinge screws.

- 4 Install the two decorative screws, the latch, and two latch screws removed in step 1 on the opposite side from which they were removed.

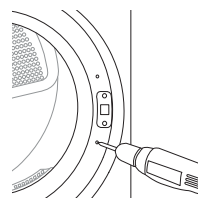

- 5 Check that the door closes properly.

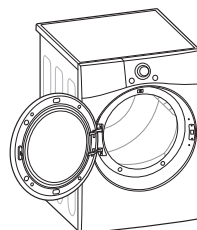

## Installing the Side Vent Kit

### **⚠ WARNING**

To reduce the risk of serious injury, death or property damage, follow basic precautions, including the following:

- Use long-sleeved gloves and safety glasses.
- Use a heavy metal vent.
- Do not use plastic or thin foil ducts.
- Clean old ducts before installing this dryer.

Your new dryer is configured to vent to the rear. It can also vent to the bottom or side (right-side venting is not available on gas models).

An adapter kit, part number 383EEL9001B, may be purchased from your LG retailer. This kit contains duct components necessary to change the dryer vent location.

- 1 Remove the rear exhaust duct retaining screw. Pull out the exhaust duct.

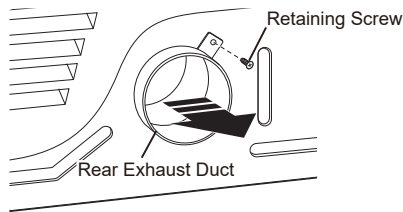

### Option 1: Side Venting

- 2 Press the tabs on the knockout and carefully remove the knockout for the desired vent opening (right-side venting is not available on gas models). Press the adapter duct onto the blower housing and secure to the base of the dryer as shown.

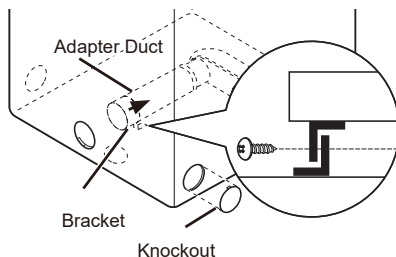

- 3 Preassemble a 4-inch (10.2 cm) elbow to the next 4-inch (10.2 cm) duct section, and secure all joints with duct tape. Be sure that the male end of the elbow faces AWAY from the dryer. Insert the elbow/duct assembly through the side opening and press it onto the adapter duct. Secure it in place with duct tape. Be sure that the male end of the duct protrudes 1.5 inches (3.8 cm) to connect the remaining ductwork. Attach the cover plate to the back of the dryer with the included screw.

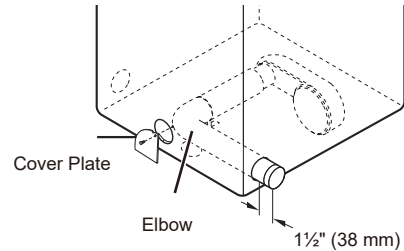

### Option 2: Bottom Venting

- 2 Press the adapter duct onto the blower housing and secure it to the base of the dryer as shown.

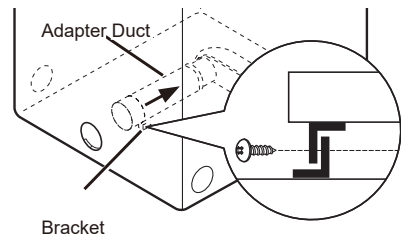

- 3 Insert the 4-inch (10.2 cm) elbow through the rear opening and press it onto the adapter duct. Be sure that the male end of the elbow faces down through the hole in the bottom of the dryer. Secure it in place with duct tape. Attach the cover plate to the back of the dryer with the included screw.

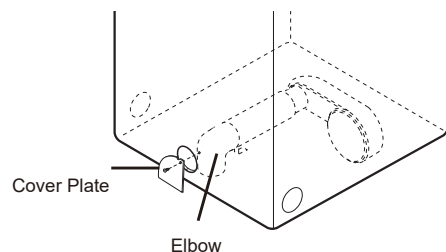

# Stacking the Dryer

## Stacking Kit Installation

This stacking kit includes:

- Two (2) side rails
- One (1) front rail
- Four (4) screws

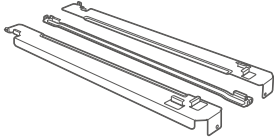

Tools Needed for Installation:

- Phillips screwdriver



### **! WARNING**

**To reduce the risk of electrical shock, fire, explosion, property damage, serious injury or death, follow basic precautions, including the following:**

- The weight of the dryer and the height of installation make this stacking procedure too risky for one person. Two or more people are required when installing the stacking kit.
- Do not use the stacking kit with a gas dryer in potentially unstable conditions such as a mobile home.
- Place the washer on a solid, stable, level floor capable of supporting the weight of both appliances.
- Do not stack the washer on top of the dryer.
- If appliances are already installed, disconnect them from all power, water, or gas lines and from draining or venting connections.

To ensure safe and secure installation, please observe the following instructions.

- 1** Make sure the surface of the washer is clean and dry. Remove paper backing from the tape on one of the stacking kit side brackets.

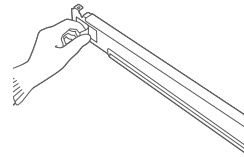

- 2** Fit the side bracket to the side of the washer top as shown in the below illustration. Firmly press the adhesive area of the bracket to the washer surface. Secure the side bracket to the washer with a screw on the back side of the bracket. Repeat steps 1 and 2 to attach the other side bracket.

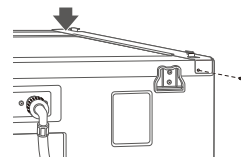

- 3** Place the dryer on top of the washer, fitting the dryer feet into the side brackets as illustrated. Avoid finger injuries; do not allow fingers to be pinched between the washer and dryer. Slowly slide the dryer toward the back of the washer until the side bracket stoppers catch the dryer feet.

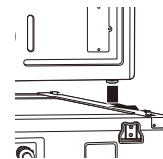

- 4** Insert the front rail between the bottom of the dryer and the top of the washer. Push the front rail toward the back of the washer until it comes in contact with the side rail stoppers.

Install the two remaining screws to secure the front rail to the side rails.

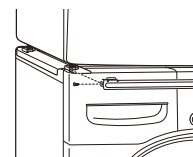

## Venting the Dryer

### WARNING



To reduce the risk of fire or explosion, electric shock, property damage, injury to persons or death when using this appliance, follow basic safety precautions, including the following:

- Do not crush or collapse ductwork.
- Do not allow ductwork to rest on or contact sharp objects.
- If connecting to existing ductwork, make sure it is suitable and clean before installing the dryer.
- Venting must conform to local building codes.
- Gas dryers **MUST** exhaust to the outdoors.
- Use only 4-inch (10.2 cm) rigid, semi-rigid or flexible metal ductwork inside the dryer cabinet and for venting outside.
- To reduce the risk of fire, combustion, or accumulation of combustible gases, **DO NOT** exhaust dryer air into an enclosed and unventilated area, such as an attic, wall, ceiling, crawl space, chimney, gas vent, or concealed space of a building.
- To reduce the risk of fire, **DO NOT** exhaust the dryer with plastic or thin foil ducting.
- The exhaust duct must be 4-inch (10.2 cm) in diameter with no obstructions. The exhaust duct should be kept as short as possible. Make sure to clean any old ducts before installing your new dryer.
- Rigid, semi-rigid or flexible metal ducting is recommended for use between the dryer and the wall. All non-rigid metal transition duct must be UL-listed. Use of other materials for transition duct could affect drying time.
- **DO NOT** use sheet metal screws or other fasteners which extend into the duct that could catch lint and reduce the efficiency of the exhaust system. Secure all joints with duct tape.
- Do not exceed the recommended duct length limitations noted in the chart. Failure to follow these instructions may result in extended drying times, fire or death.

### WARNING

- Ductwork is not provided with the dryer. You should obtain the necessary ductwork locally. The vent hood should have hinged dampers to prevent backdraft when the dryer is not in use.
- The total length of flexible metal duct must not exceed 8 ft. (2.4 m).

## Ductwork

Wall Cap Type	Number of 90° Elbows	Maximum length of 4-inch diameter rigid metal duct	
 a: 4" (10.2 cm)	Recommended	0	65 ft.(19.8 m)
		1	55 ft.(16.8 m)
		2	47 ft.(14.3 m)
		3	36 ft.(11.0 m)
 b: 2.5" (6.35 cm)	Use only for short run installations	0	55 ft.(16.8 m)
		1	47 ft.(14.3 m)
		2	41 ft.(12.5 m)
		3	30 ft.(9.1 m)
	4	22 ft.(6.7 m)	

### NOTE

- Deduct 6 ft. (1.8 m) for each additional elbow. Do not use more than four 90° elbows.
- In Canada, only those foil-type flexible ducts, if any, specifically identified for use with the appliance by the manufacturer should be used. In the United States, only those foil-type flexible ducts, if any, specifically identified for use with the appliance by the manufacturer and that comply with the Outline for Clothes Dryer Transition Duct, Subject 2158A, should be used.

## Routing and Connecting Ductwork

### NOTE

Follow the guidelines below to maximize drying performance and reduce lint buildup and condensation in the ductwork. Ductwork and fittings are **NOT** included and must be purchased separately.

- Use 4-inch (10.2 cm) diameter rigid, semi-rigid or flexible metal ductwork.
- The exhaust duct run should be as short as possible.
- Use as few elbow joints as possible.
- The male end of each section of exhaust duct must point away from the dryer.
- Use duct tape on all duct joints.
- Insulate ductwork that runs through unheated areas in order to reduce condensation and lint buildup on duct surfaces.
- Incorrect or inadequate exhaust systems are not covered by the dryer warranty. Dryer failures or service required because of such exhaust systems will not be covered by the dryer warranty.

## Correct Venting

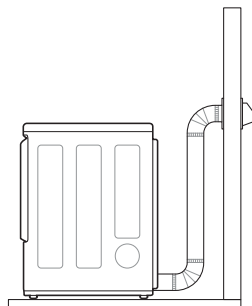

## Incorrect Venting

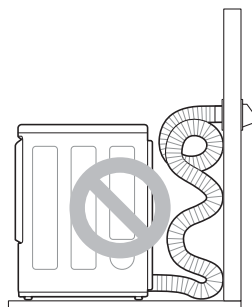

## Connecting the Inlet Hose (Steam Models)

The dryer must be connected to the cold water tap using the new water supply hose. Do not reuse old hoses.

### NOTE

- Water supply pressure must be between 20 and 120 psi (138—827 kPa).
- Do not strip or cross-thread when connecting the inlet hose to the valve.
- If the water supply pressure is more than 800 kPa, a pressure-reducing valve should be installed.
- Periodically check the condition of the hose and replace the hose if necessary.
- Replace inlet hoses after 5 years of use to reduce the risk of hose failure.
- Record hose installation or replacement dates on the hoses for future reference.

- 1** Check the rubber seal at each end of the inlet hoses. Two rubber seals are supplied with each inlet hose. They are used for preventing water leaks. Make sure the connection to the cold water tap is tight.

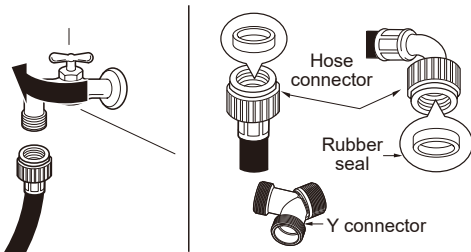

- 2** Check the installation type.

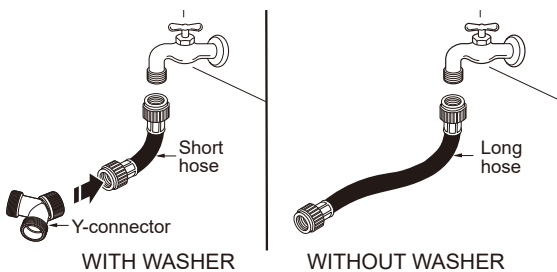

Connect all water supply hoses tightly by hand and then tighten another 2/3 turn with pliers.

**WITH WASHER:** When connecting the dryer to the same faucet as a washer.

- Shut off the cold water tap and remove the washer hose.
- Connect the short hose to the Y-connector using one of the rubber seals.
- Connect the other end of the short hose to the cold water faucet.
- Connect the long dryer hose to one side of the Y-connector and connect the washer hose to the other side.

**WITHOUT WASHER:** If the dryer does not share the cold water tap with a washer.

- Connect the straight end of the long hose to the cold water faucet.

### NOTE

- Before connecting the water line to the dryer, flush several gallons of water into a drain or bucket. This will help prevent foreign particles such as sand and scale from clogging the dryer inlet valve.
- Do not overtighten. Damage to the coupling may result.

- 3** Connect the hose to the dryer. Connect the water supply hose to the dryer inlet valve tightly by hand and then tighten another 2/3 turn with pliers. Make sure that there are no kinks in the hoses and that they are not crushed.

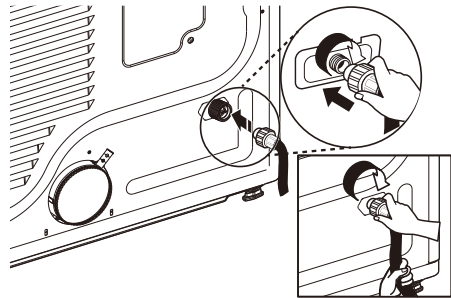

- 4** Turn on the cold water faucet.

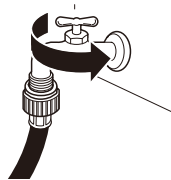

- 5** Check for leaks at the Y-connector (if used) and in all hoses.

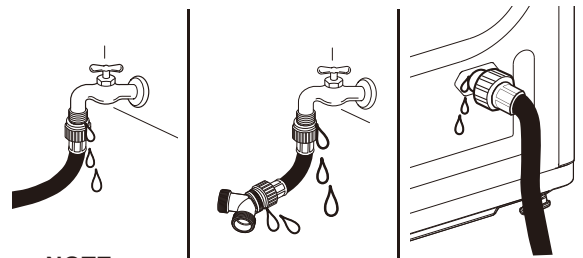

### NOTE

- If any leaks are found, shut off the water faucet, remove the hose and check the condition of the rubber seal.

## Connecting Gas Dryers

### WARNING

To reduce the risk of fire or explosion, electric shock, property damage, injury to persons, or death when using this appliance, follow requirements including the following:

#### Electrical Requirements for Gas Models Only

- Do not, under any circumstances, cut or remove the third (ground) prong from the power cord.
- For personal safety, this dryer must be properly grounded.
- This dryer must be plugged into a 120-VAC, 60-Hz. grounded outlet protected by a 15-ampere fuse or circuit breaker.
- Where a standard 2-prong wall outlet is encountered, it is your personal responsibility and obligation to have it replaced with a properly grounded 3-prong wall outlet.

#### ELECTRIC SHOCK HAZARD

Failure to follow safety warnings could result in serious injury

- This dryer is equipped with a three-prong grounding plug for protection against shock hazard and should be plugged directly into a properly grounded three-prong receptacle. Do not cut or remove the grounding prong from this plug.

#### Gas Supply Requirements

- As shipped from the factory, this dryer is configured for use with natural gas (NG). It can be converted for use with propane (LP) gas. Gas pressure must not exceed 8-inch (20.4 cm) water column for NG, or 13-inch (33.1 cm) water column for LP.
- A qualified service or gas company technician must connect the dryer to the gas service.
- Isolate the dryer from the gas supply system by closing its individual manual shutoff valve during any pressure testing of the gas supply.
- DO NOT attempt any disassembly of the dryer; disassembly requires the attention and tools of an authorized and qualified service technician or company.
- Securely tighten all gas connections.
- Connect the dryer to the type of gas shown on the nameplate.

### WARNING

#### Gas Supply Requirements (continued)

- Supply line requirements: Your laundry room must have a rigid gas supply line to your dryer. In the United States, an individual manual shutoff valve MUST be installed within at least 6 ft. (1.8 m) of the dryer, in accordance with the National Fuel Gas Code ANSI Z223.1 or Canadian gas installation code CSA B149.1. A 1/8-inch NPT pipe plug must be installed.
- If using a rigid pipe, the rigid pipe should be 0.5-inch IPS. If acceptable under local codes and ordinances and when acceptable to your gas supplier, 3/8-inch approved tubing may be used where lengths are less than 20 ft. (6.1 m). Larger tubing should be used for lengths in excess of 20 ft. (6.1 m).
- To prevent contamination of the gas valve, purge the gas supply of air and sediment before connecting the gas supply to the dryer. Before tightening the connection between the gas supply and the dryer, purge remaining air until the odor of gas is detected.
- DO NOT use an open flame to inspect for gas leaks. Use a noncorrosive leak detection fluid.
- Use only a new AGA- or CSA-certified gas supply line with flexible stainless steel connectors.
- Use Teflon tape or a pipe-joint compound that is insoluble in propane (LP) gas on all pipe threads.

#### Connecting the Gas Supply

- Installation and service must be performed by a qualified installer, service agency, or the gas supplier.
- Use only a new stainless steel flexible connector and a new AGA-certified connector.
- A gas shutoff valve must be installed within 6 ft. (1.8 m) of the dryer.
- The dryer is configured for natural gas when shipped from the factory. Make sure that the dryer is equipped with the correct burner nozzle for the type of gas being used (natural gas or propane gas).
- If necessary, the correct nozzle (for the LP nozzle kit, order part number 383EEL3002D) should be installed by a qualified technician and the change should be noted on the dryer.
- All connections must be in accordance with local codes and regulations. Gas dryers MUST exhaust to the outdoors.



**NOTE**

- In the Commonwealth of Massachusetts: This product must be installed by a licensed plumber or gas fitter. When using ball-type gas shut off valves, they shall be T-handle-type. A flexible gas connector, when used, must not exceed 3 feet.

This dryer is configured from the factory for natural gas (NG). If the dryer is to be used with propane (LP) gas, it must be converted by a qualified service technician.

- 1 Make sure that the gas supply to the laundry room is turned OFF and the dryer is unplugged. Confirm that the type of gas available in your laundry room is appropriate for the dryer.
- 2 Remove the shipping cap from the gas fitting at the back of the dryer. Be careful not to damage the threads of the gas connector when removing the shipping cap.
- 3 Connect the dryer to your laundry room's gas supply using a new flexible stainless steel connector with a 3/8-inch NPT fitting.

**NOTE**

- DO NOT use old connectors.

- 4 Securely tighten all connections between the dryer and your laundry room's gas supply.
- 5 Turn on your laundry room's gas supply.
- 6 Check all pipe connections (both internal and external) for gas leaks with a noncorrosive leak-detection fluid.
- 7 Proceed to Venting the Dryer.

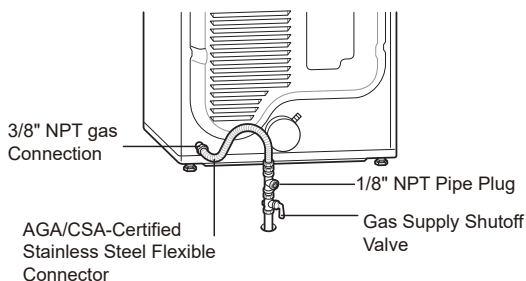
**High-Altitude Installations**

The BTU rating of this dryer is AGA-certified for elevations below 10,000 feet.

If your gas dryer is being installed at an elevation above 10,000 feet, it must be derated by a qualified technician or gas supplier.

## Connecting Electric Dryers

### WARNING

To reduce the risk of fire or explosion, electric shock, property damage, injury to persons, or death when using this appliance, follow requirements including the following:

#### Electrical Requirements for Electric Models Only

- The wiring and grounding must conform to the latest edition of the National Electrical Code, ANSI/NFPA 70 and all applicable local regulations. Please contact a qualified electrician to check your home's wiring and fuses to ensure that your home has adequate electrical power to operate the dryer.
- This dryer must be connected to a grounded metal, permanent wiring system, or an equipment-grounding conductor must be run with the circuit conductors and connected to the equipment-grounding terminal or lead on the dryer.
- The dryer has its own terminal block that must be connected to a separate 240 VAC, 60-Hertz, single-phase circuit, fused at 30 amperes (the circuit must be fused on both sides of the line). ELECTRICAL SERVICE FOR THE DRYER SHOULD BE OF THE MAXIMUM RATE VOLTAGE LISTED ON THE NAMEPLATE. DO NOT CONNECT THE DRYER TO 110-, 115-, OR 120-VOLT CIRCUIT.
- If the branch circuit to dryer is 15 ft. (4.5 m) or less in length, use UL (Underwriters Laboratories) listed No.-10 AWG wire (copper wire only), or as required by local codes. If over 15 ft. (4.5 m), use UL-listed No.-8 AWG wire (copper wire only), or as required by local codes. Allow sufficient slack in wiring so the dryer can be moved from its normal location when necessary.
- The power cord (pigtail) connection between the wall receptacle and the dryer terminal block IS NOT supplied with the dryer. Type of pigtail and gauge of wire must conform to local codes and with instructions on the following pages.

### WARNING

- A 4-wire connection is required for all mobile and manufactured home installations, as well as all new construction after January 1, 1996. A 4-wire connection must be used where local codes do not permit grounding through the neutral wire.
- Do not modify the plug and internal wire provided with the dryer.
- The dryer should be connected to a 4-hole outlet.
- If the plug does not fit the outlet, a proper outlet will need to be installed by a qualified electrician.
- Connect the power cord to the terminal block. Each colored wire should be connected to the same color screw. Wire color indicated on manual is connected to the same color screw in the block.
- Grounding through the neutral conductor is prohibited for: (1) new branch-circuit installations, (2) mobile homes, (3) recreational vehicles, and (4) areas where local codes prohibit grounding through the neutral conductor.
- This dryer is supplied with the neutral wire grounded. This white ground wire **MUST BE MOVED** to the neutral terminal when a 4-wire cord is to be used, or where grounding through the neutral conductor is prohibited.

#### NOTE

- For electrical requirements for mobile or manufactured homes, see **Special Electrical Requirements**.

### Four-Wire Power Cord

- A 4-wire connection is required for all mobile and manufactured home installations, as well as all new construction after January 1, 1996.
- A UL-listed strain relief is required.
- Use a 30-amp, 240-volt, 4-wire, UL-listed power cord with #10 AWG-minimum copper conductor and closed loop or forked terminals with upturned ends.

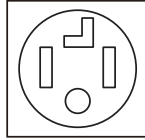

- 1 Remove the terminal block access cover on the upper back of the dryer.
- 2 Install a UL-listed strain relief into the power cord through-hole.
- 3 Thread a 30-amp, 240-volt, 4-wire, UL-listed power cord with #10 AWG-minimum copper conductor through the strain relief.

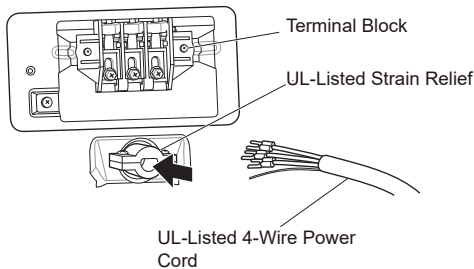

- 4 Transfer the dryer's ground wire from behind the green ground screw to the center screw of the terminal block.
- 5 Attach the two hot leads of the power cord to the outer terminal block screws.
- 6 Attach the white neutral wire to the center screw of the terminal block.
- 7 Attach the power cord ground wire to the green ground screw.

- 8 Tighten all screws securely.
- 9 Reinstall the terminal block access cover.

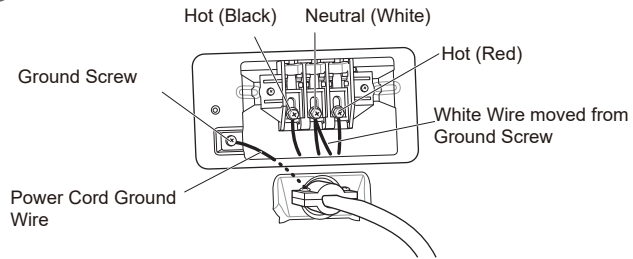

### Four-Wire Direct Wire

- A 4-wire connection is required for all mobile and manufactured home installations, as well as all new construction after January 1, 1996.
- A UL-listed strain relief is required.
- Use UL-listed 4-wire #10 AWG-minimum copper conductor cable. Allow at least 5 ft. (1.5 m) of wire to allow for removal and reinstallation of the dryer.

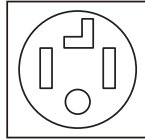

- 1 Remove 5-inch (12.7 cm) of the outer covering from the wire. Remove 5-inch of insulation from the ground wire. Cut off approximately 1.5-inch (3.8 cm) from the other three wires and strip 1 inch (2.5 cm) insulation from each wire. Bend the ends of the three shorter wires into a hook shape.

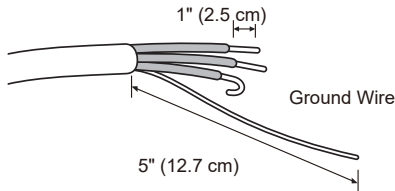

- 2 Remove the terminal block access cover on the upper back of the dryer.
- 3 Install a UL-listed strain relief into the power cord through-hole.
- 4 Thread the 4-wire #10 AWG-minimum copper power cable prepared in step 1 through the strain relief.

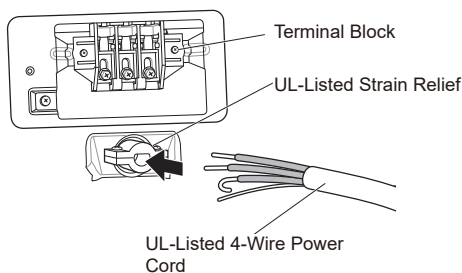

- 5 Transfer the dryer's ground wire from behind the green ground screw to the center screw of the terminal block.

- 6 Attach the two hot leads of the power cord to the outer terminal block screws.
- 7 Attach the white neutral wire to the center screw of the terminal block.
- 8 Attach the power cord ground wire to the green ground screw.
- 9 Tighten all screws securely.

- 10 Reinstall the terminal block access cover.

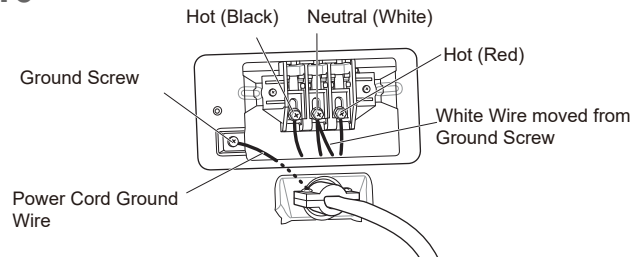

### Three-Wire Power Cord

- A 3-wire connection is NOT permitted on new construction after January 1, 1996.
- A UL-listed strain relief is required.
- Use a 30-amp, 240-volt, 3-wire, UL-listed power cord with #10 AWG-minimum copper conductor and closed loop or forked terminals with upturned ends.

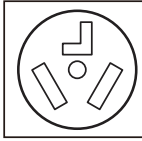

- 1 Remove the terminal block access cover on the upper back of the dryer.
- 2 Install a UL-listed strain relief into the power cord through-hole.
- 3 Thread a 30-amp, 240-volt, 3-wire, UL-listed power cord with #10 AWG-minimum copper conductor through the strain relief.

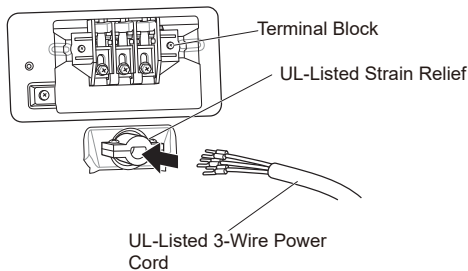

- 4 Attach the two hot leads (black and red) of the power cord to the outer terminal block screws.
- 5 Attach the neutral (white) wire to the center terminal block screw.
- 6 Connect the external ground (if required by local codes) to the green ground screw.
- 7 Tighten all screws securely.

- 8 Reinstall the terminal block access cover.

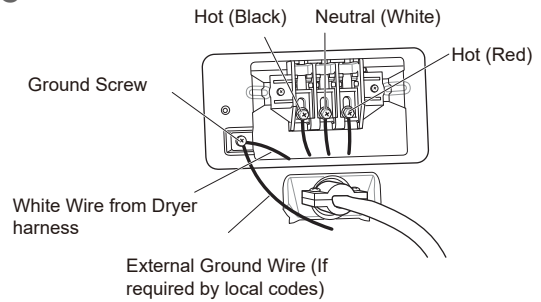

### Three-Wire Direct Wire

- A 3-wire connection is NOT permitted on new construction after January 1, 1996.
- A UL-listed strain relief is required.
- Use UL-listed 3-wire, #10 AWG-minimum copper conductor cable. Allow at least 5 ft. (1.5 m) length to allow for removal and installation of dryer.



- 1 Remove 3.5-inch (8.9 cm) of the outer covering from the wire. Strip 1 inch (2.5 cm) insulation from each wire. Bend the ends of the three wires into a hook shape.

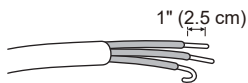

- 2 Remove the terminal block access cover on the upper back of the dryer.
- 3 Install a UL-listed strain relief into the power cord through-hole.
- 4 Thread the 3-wire, #10 AWG-minimum copper conductor power cable prepared in step 1 through the strain relief.

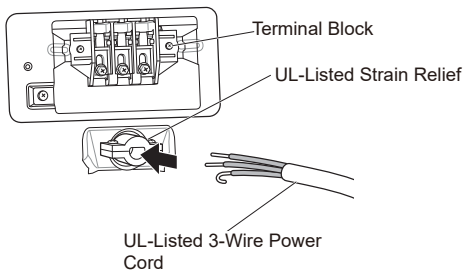

- 5 Attach the two hot leads (black and red) of the power cord to the outer terminal block screws.

- 6 Attach the neutral (white) wire to the center terminal block screw.
- 7 Connect the external ground (if required by local codes) to the green ground screw.
- 8 Tighten all screws securely.
- 9 Reinstall the terminal block access cover.

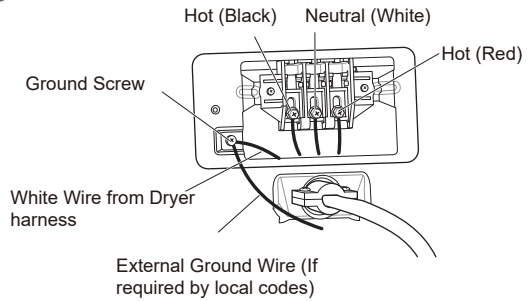

## Special Electrical Requirements

### (For Mobile or Manufactured Homes)

- Any installation in a manufactured or mobile home must comply with the Manufactured Home Construction and Safety Standards Title 24 CFR, Part 3280 or Standard CAN/ CSA Z240 MH and local codes and ordinances. If you are uncertain whether your proposed installation will comply with these standards, please contact a service and installation professional for assistance.
- A 4-wire connection is required for all mobile and manufactured home installations, as well as all new construction after January 1, 1996.
- A gas dryer must be permanently attached to the floor.
- The electrical connection for an electric dryer must be a 4-wire connection. More detailed information concerning the electrical connection is provided in the section Connecting Electric Dryers.
- To reduce the risk of combustion and fire, the dryer must be vented to the outside.
- DO NOT vent the dryer under a manufactured home or mobile home.
- Electric dryers may be vented to the outside using the back, left, right, or bottom panel.
- Gas dryers may be vented to the outside using the back, left, or bottom panel. Gas dryers may not be vented to the outside using the right side panel because of the burner housing.
- The dryer exhaust duct must be affixed securely to the manufactured or mobile home structure, and the exhaust duct must be made of a material that will resist fire and combustion. It is recommended that you use a rigid, semi-rigid or flexible metal duct.
- DO NOT connect the dryer exhaust duct to any other duct, vent, chimney, or other exhaust duct.
- Make sure the dryer has adequate access to outside fresh air to ensure proper operation. The opening for outside fresh air must be at least 25 sq. in (163 cm<sup>2</sup>).
- It is important that the clearance of the duct from any combustible construction be at least 2 inches (5 cm), and when venting the dryer to the outdoors, the dryer should be installed with a clearance of at least 1 inch (2.5 cm) at the sides and back of the dryer.
- Please be aware that venting materials are not supplied with the dryer. You must obtain the venting materials necessary for proper installation.

## Final Installation Check

Once you have completed the installation of the dryer and it is in its final location, confirm proper operation with the following tests and Installation Test (Duct Check).

### Testing Dryer Heating

#### GAS MODELS

Close the dryer door and press the **Power** button to turn the dryer on. Press the **Time Dry** and **Start/Pause** buttons to start the test. When the dryer starts, the igniter should ignite the main burner.

#### NOTE

- If all air is not purged from the gas line, the gas igniter may turn off before the main burner ignites. If this happens, the igniter will reattempt gas ignition after approximately two minutes.

#### ELECTRIC MODELS

Close the dryer door and press the **Power** button to turn the dryer on. Press the **Time Dry** and **Start/Pause** buttons to start the test. The exhaust air should be warm after the dryer has been operating for 3 minutes.

### Checking Airflow

Effective dryer operation requires proper airflow. The adequacy of the airflow can be measured by evaluating the static pressure. Static pressure in the exhaust duct can be measured with a manometer, placed on the exhaust duct approximately 2 ft. (60.9 cm) from the dryer. Static pressure in the exhaust duct should not exceed 0.6 inch (1.5 cm). The dryer should be checked while the dryer is running with no load.

### Checking Levelness

Once the dryer is in its final location, recheck the dryer to be sure it is level. Make sure it is level front to back and side to side, and that all four leveling feet are in firm contact with the floor.



## Installation Test (Duct Check)

Once you have completed the installation of the dryer, use this test to make sure the condition of the exhaust system is adequate for proper operation of the dryer. This test should be performed to alert you to any serious problems in the exhaust system of your home.

- Your dryer features Flow Sense™, an innovative sensing system that automatically detects blockages and restrictions in dryer ductwork. Keeping ductwork clean of lint buildup and free of restrictions allows clothes to dry faster and reduces energy use.

### NOTE

- The dryer should be cool before starting this test. If the dryer was warmed up during installation, run the Air Dry cycle for a few minutes to reduce the interior temperature.

### Activating the Installation Test

- Remove the drying rack and literature, and then close the door.**

Do not load anything in the drum for this test, as it may affect the accuracy of the results.

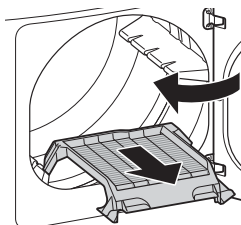

- (DLEX4200\*, DLGX4201\*, DLEX4000\*, DLGX4001\*, DLEX4500\*, DLGX4501\*) Press and hold Signal and Temp.**

**(DLE3600\*, DLG3601\*) Press and hold Energy Saver and Temp.**

**Then press the Power button.**

(On models with a glass touch control panel, press the **Power** button then IMMEDIATELY press and hold the other 2 buttons.

This button sequence activates the installation test. The code **1n5** will display if the activation is successful.

**(DLEX4200\*,DLGX4201\*  
DLEX4000\*,DLGX4001\*,  
DLEX4500\*, DLGX4501\*)**

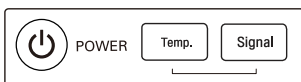

**(DLE3600\*,DLG3601\*)**

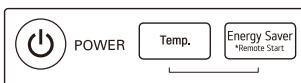

- Press the START/PAUSE button.**

The dryer will start the test, which will last a few minutes. The heat will be turned on and the temperatures in the drum will be measured.

- Check the display for results.**

**(DLEX4200\*,DLGX4201\*, DLEX4000\*, DLGX4001\*, DLEX4500\*, DLGX4501\*)**

During the test cycle, monitor the Flow Sense™ display on the control panel. If the Flow Sense™ LED has not turned on, when the cycle ends, the exhaust system is adequate. If the exhaust system is severely restricted, the Flow Sense™ LED will turn on. Other problems may also be shown with error codes. See the chart on the next page for error code details and solutions.



LED turned on:  
**RESTRICTED**

The Flow Sense™ LED indicates that the exhaust system is severely restricted. Have the system checked immediately, as performance will be poor.

**(DLE3600\*,DLG3601\*)**

During the test cycle, monitor the Flow Sense™ display on the control panel. If no bars are displayed, when the cycle ends, the exhaust system is adequate. If the exhaust system is severely restricted, the display will show four bars. Other problems may also be shown with error codes. Refer to the next page for error code details and solutions.



Flow Sense

**NO BARS:  
OK**



Flow Sense

**FOUR BARS:  
RESTRICTED**

Four bars indicates that the exhaust system is severely restricted. Have the system checked immediately, as performance will be poor.

- End of cycle.**

**(DLEX4200\*,DLGX4201\*, DLEX4000\*, DLGX4001\*, DLEX4500\*, DLGX4501\*)**

At the end of the test cycle, **End** will display. The test cycle will end and the dryer will shut off automatically after a short delay.



**(DLE3600\*,DLG3601\*)**

At the end of the test cycle, **0** will display. The test cycle will end and the dryer will shut off automatically after a short delay.



### Check the Duct Condition

If the Flow Sense™ Display is turned on, check the exhaust system for restrictions and damage. Repair or replace the exhaust system as needed.

#### NOTE

- When the dryer is first installed, this test should be performed to alert you to any existing problems with the exhaust duct in your home. However, since the test performed during normal operation provides more accurate information on the condition of the exhaust duct than the installation test, the number of bars displayed during the two tests may not be the same.
- Do not interrupt the test cycle, as this could result in inaccurate results.
- Even if the Flow Sense display does not light up during the test cycle, some restrictions may still be present in the exhaust system. Refer to the Venting the Dryer section of this manual for complete exhaust system and venting requirements.

### Error Codes

Check the error code before you call for service.

Error Code	Possible Causes	Solutions
tE1 or tE2	Temperature sensor failure.	Turn off the dryer and call for service.
HS	Humidity sensor failure.	Turn off the dryer and call for service.
PS, PF, or nP	Electric dryer power cord is not connected correctly, or house power supply is incorrect.	Check the power supply or the connection of the power cord to the terminal block. Refer to the Connecting Electric Dryers section of this manual for complete instructions.
	House fuse is blown, circuit breaker has tripped, or power outage has occurred.	Reset circuit breaker or replace fuse. Do not increase the fuse capacity. If the problem is a circuit overload, have it corrected by a qualified electrician.
gAS	Gas supply or service turned off. (Gas Model only.)	Confirm that house gas shutoff and the dryer gas shutoff are both fully open.

### Restricted or Blocked Airflow

Avoid long runs or runs with multiple elbows or bends.

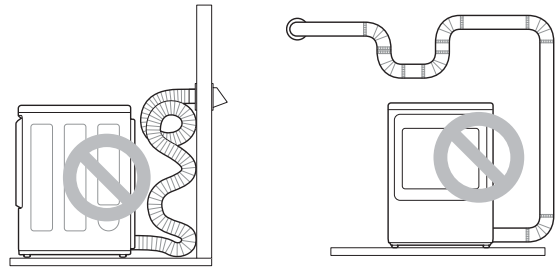

Excess or crushed transition duct

Too many elbows or exhaust too long

Check for blockages and lint buildup.

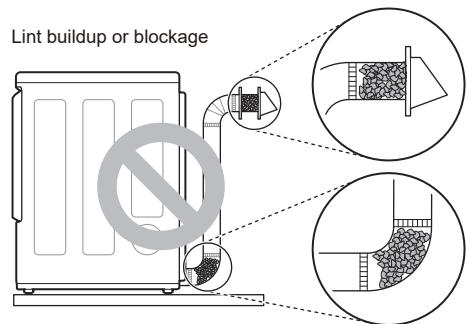

Make sure the ductwork is not crushed or restricted.

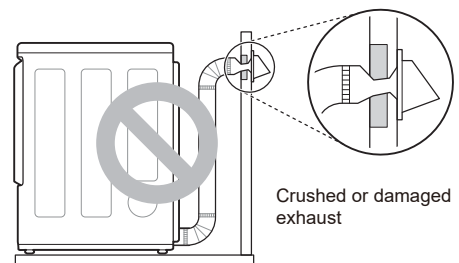

# OPERATION

## ⚠ WARNING

- To reduce the risk of fire, electric shock, or injury to persons, read the SAFETY INSTRUCTIONS before operating this appliance.

## Using the Dryer

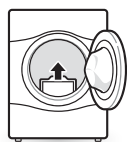

### 1 Clean the Lint Filter

If the lint filter has not already been cleaned, lift out the filter and remove the lint from the last load. This will help ensure the fastest and most efficient drying performance. Make sure to reinstall the filter, pressing down until it clicks firmly into place.

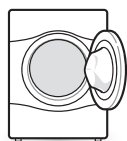

### 2 Load the Dryer

Load the dryer with the wet laundry from the washer. If the load is extra large, you may need to divide it into smaller loads for proper performance and fabric care.



### 3 Turn on the Dryer

Press the **Power** button to turn on the dryer. The cycle LEDs will illuminate and a chime will sound.



### 4 Select a Cycle

Turn the cycle selector knob in either direction until the LED for the desired cycle is on. The preset temperature, dry level, and option settings for that cycle will be shown. Default settings for the selected cycle can now be changed if desired. Refer to the Cycle Setting and Options page for details.

#### NOTE

- Not all options or modifiers are available on all cycles. Refer to the Cycle Guide page for default settings and available options. A different chime will sound and the LED will not come on if the selection is not available.



### 5 Begin Cycle

Press the **Start/Pause** button to begin the cycle. The cycle can be paused at any time either by opening the door or by pressing the **Start/Pause** button. If the cycle is not restarted within 14 minutes of being paused, the dryer will shut off and the settings will be lost.



### 6 End of Cycle

When the cycle is finished, the chime will sound. Immediately remove your clothing from the dryer to reduce wrinkling. If Wrinkle Care is selected, the dryer will tumble briefly every few minutes to help prevent wrinkles from setting in the clothes.

## Check the Lint Filter Before Every Load

Always make sure the lint filter is clean before starting a new load; a clogged lint filter will increase drying time. To clean, pull the lint filter straight up and roll any lint off the filter with your fingers. Push the lint filter firmly back into place. See **Regular Cleaning** for more information.

Always ensure the lint filter is properly installed before running the dryer. Running the dryer with a loose or missing lint filter will damage the dryer and articles in the dryer.

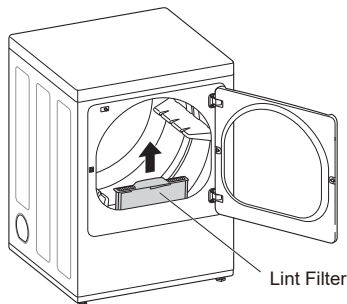

## Sorting Laundry

### Fabric Care Labels

Many articles of clothing include a fabric care label. Using the chart below, adjust the cycle and option selections to care for your clothing according to the manufacturer's recommendations.

Tumble dry			
	Dry		Gentle/delicate
	Normal		Do not tumble dry
	Permanent Press/ wrinkle resistant		Do not dry (used with do not wash)
Heat setting			
	High		Low
	Medium		No heat/air

## Grouping Similar Items

For best results, sort clothes into loads that can be dried with the same drying cycle.

Different fabrics have different care requirements, and some fabrics will dry more quickly than others.

## Loading the Dryer

### WARNING

To reduce the risk of fire, explosion, electric shock, injury to persons, and death when using this appliance, follow basic precautions, including the following:

- Check all pockets to make sure that they are empty. Items such as clips, pens, coins, and keys can damage both the dryer and your clothes. Flammable objects such as lighters or matches could ignite, causing a fire.
- Never dry clothes that have been exposed to oil, gasoline, or other flammable substances. Washing clothes will not completely remove oil residues.

### NOTE

#### Loading Tips

- Combine large and small items in the same load.
- Damp clothes will expand as they dry. Do not overload the dryer; clothes require room to tumble and dry properly.
- Use mesh laundry bags to separate clothes with zippers, hooks, straps, and drawstrings to prevent them from catching on or tangling with other clothes or damaging the lint filter.

# Control Panel

## Non-Steam Models (DLE3600\*, DLG3601\*)

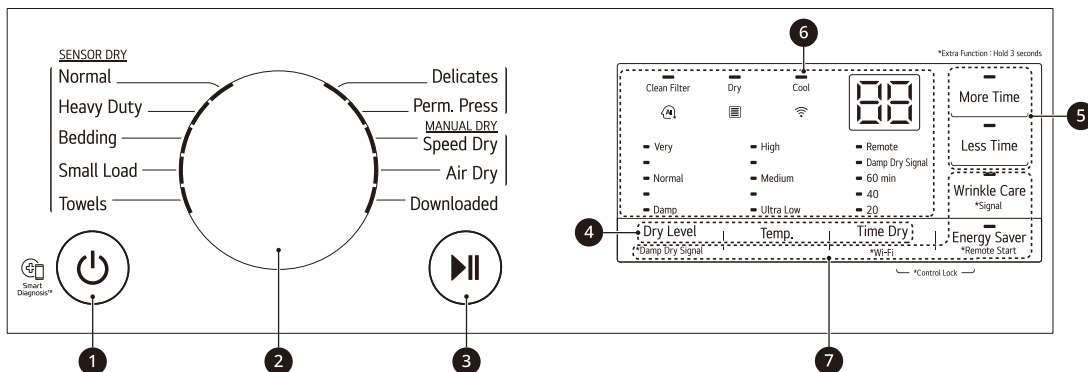

## Steam Models (DLEX4000\*, DLGX4001\*)

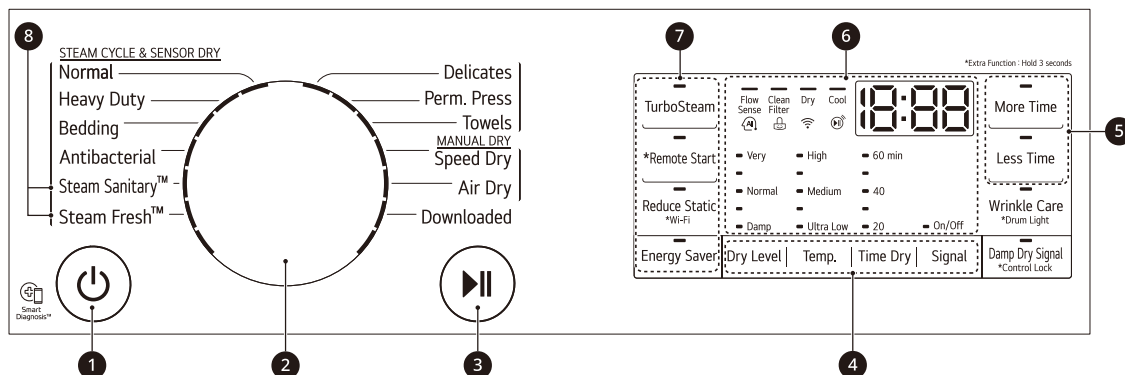

## Steam Models (DLEX4200\*, DLGX4201\*, DLEX4500\*, DLGX4501\*)

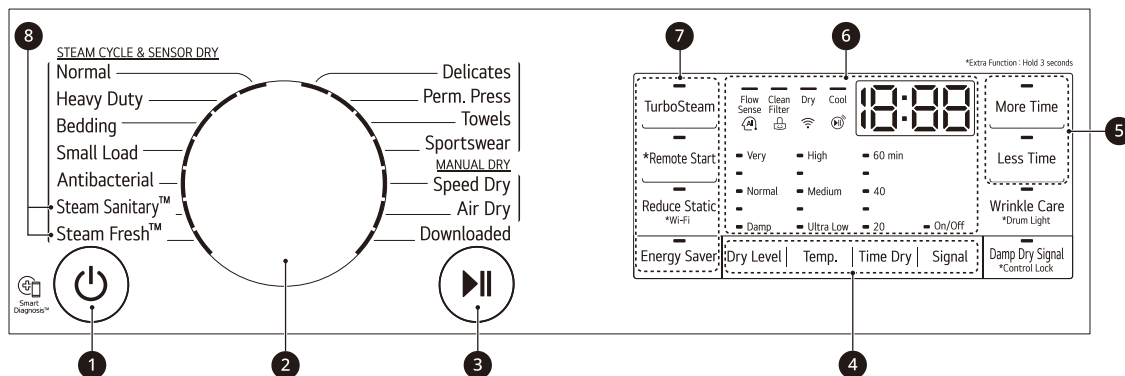

### NOTE

- Model numbers can be found on the cabinet inside the door.

**1 Power Button**

Press the button to turn the dryer ON. Press again to turn the dryer OFF.

**NOTE**

- Pressing the **Power** button during a cycle will cancel that cycle and any load settings will be lost.

**2 Cycle Selector Knob**

Turn this knob to select the desired cycle. Once the desired cycle has been selected, the standard presets will be shown in the display. On Manual Dry cycles, these settings can be adjusted using the cycle modifier buttons anytime before starting the cycle.

**3 Start/Pause Button**

Press this button to start the selected cycle. If the dryer is running, use this button to pause the cycle without losing the current settings.

**NOTE**

- If you do not press the **Start/Pause** button to resume a cycle within 14 minutes, the dryer turns off automatically and all cycle settings are lost.

**4 Cycle Modifier Buttons**

Use these buttons to select the desired cycle settings for the selected cycle. The current settings are shown in the display. Press the button for that option to view and select other settings.

**5 More Time/Less Time Buttons**

Use these buttons with the Time Dry and other Manual Dry cycles to adjust the drying time. Press the **More Time** button to increase the selected manual cycle time by 5 minutes; press the **Less Time** button to decrease the cycle time by 5 minutes.

**6 Time and Status Display**

The display shows the settings, estimated time remaining, options, and status messages for the dryer.

**7 Cycle Option Buttons**

Press each of these buttons to select additional cycle options. Press and hold any button marked with an asterisk for 3 seconds to activate a special function.

**8 Steam Functions**

LG's steam technology allows you to inject fabrics with a swirling jet of steam to refresh clothes, reduce static, and make ironing easier. Simply select the **Steam Fresh™** or **Steam Sanitary™** cycle or add a Steam option to selected cycles.

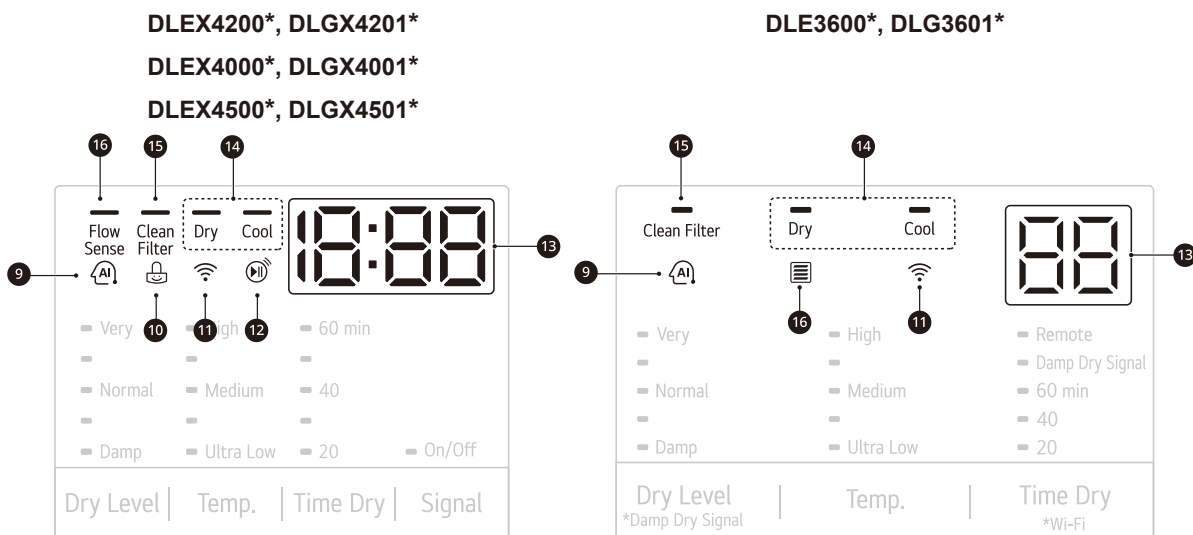

### 9 AI Sensor DRY Indicator

- AI Sensor Dry optimizes drying times and temperatures by detecting the laundry's characteristics.
- The indicator lights up when the Normal cycle is selected with the Normal dry level, except when the Energy Saver option is turned on.

### 10 Control Lock Indicator

When Control Lock is set, the Control Lock indicator appears and all buttons are disabled except the **POWER** button. This prevents children from changing settings while the dryer is operating.

### 11 Wi-Fi Indicator

When the appliance is connected to the Internet through a home Wi-Fi network, this indicator appears.

### 12 Remote Start Indicator

This indicator lights up when the **Remote Start** feature is activated.

### 13 Estimated Time Remaining

This display shows the estimated time remaining for Sensor Dry cycles or the actual time remaining for Time Dry or Manual Dry cycles.

#### NOTE

- The cycle time on Sensor Dry cycles may fluctuate as the dryer recalculates drying time for optimal results.

### 14 Cycle Completion Indicator

This portion of the display shows which stage of the drying cycle is currently underway (Dry or Cool).

### 15 Clean Filter Reminder

The display will show Clean Filter when the dryer is turned on as a reminder to clean the filter. It turns off when the **START/PAUSE** button is pressed.

### 16 Flow Sense Duct Blockage Sensing System Indicator

The Flow Sense™ duct blockage sensing system detects and alerts you to blockages in the ductwork that reduce exhaust flow from the dryer. Maintaining a clean exhaust system improves operating efficiency and helps minimize service calls, saving you money.



## Cycle Guide

### Sensor Dry Cycles

Sensor Dry cycles utilize LG's unique dual sensor system to detect and compare the moisture level in clothes and in the air and adjust the drying time as needed to ensure superior results. The dryer automatically sets the dryness level and temperature at the recommended setting for each cycle. The estimated time remaining will be shown in the display.

#### NOTE

- To protect your garments not every dryness level, temperature, or option is available with every cycle. See the Cycle Guide for details.

### Manual Dry Cycles

Use Manual Dry cycles to select a specific amount of drying time and a drying temperature. When a Manual Dry cycle is selected, the Estimated Time Remaining display shows the actual time remaining in your cycle. You can change the actual time in the cycle by pressing the **More Time** or **Less Time** buttons.

#### NOTE

- The Energy Saver option is turned on by default in the Normal Cycle. Turn off the Energy Saver option for a faster Normal cycle which begins with heated drying. To turn the Energy Saver default off, press and hold the **Energy Saver** button. ON or OFF appears in the display.

## Non-Steam Models (DLE3600\*, DLG3601\*)

= default setting

● = allowable option

\* = Energy Saver on by default

Cycle	Fabric Type	Dry Level	Temp.	Wrinkle Care	Damp Dry Signal
<b>SENSOR DRY</b>					
<b>Normal*</b>	Work clothes, corduroys, etc.	Normal	Med. High (between Medium and High)	●	●
		Adj.			
<b>Heavy Duty</b>	Jeans, heavyweight items	Normal	High	●	●
		Adj.			
<b>Bedding</b>	Comforters, Pillows, Shirts	Normal	Medium		
		Adj.			
<b>Towels</b>	Denim, towels, heavy cottons	Normal	Med. High (between Medium and High)	●	●
		Adj.			
<b>Small Load</b>	Only normal & cotton/towels fabric type (Max. 3 lb)	Normal	High	●	
		Adj.			
<b>Perm. Press</b>	Permanent press, synthetic items	Normal	Medium	●	●
		Adj.			
<b>Delicates</b>	Lingerie, sheets, blouses	Normal	Low (between Medium and Ultra Low)	●	●
		Adj.			
<b>MANUAL DRY</b>					
<b>Speed Dry</b>	For small loads with short drying times	Off	High	●	
			Adj.		
<b>Air Dry</b>	For items that require heat-free drying such as plastics or rubber	Off	No Heat	●	

## Steam Models (DLEX4000\*, DLGX4001\*)

= default setting

● = allowable option

\* = Energy Saver on by default

Cycle	Fabric Type	Dry Level	Temp.	Wrinkle Care	Damp Dry Signal	Reduce Static
<b>SENSOR DRY</b>						
<b>Normal*</b>	Work clothes, corduroys, etc.	Normal	Med. High (between Medium and High)	●	●	●
		Adj.				
<b>Heavy Duty</b>	Jeans, heavyweight items	Normal	High	●	●	●
		Adj.				
<b>Bedding</b>	Comforters, pillows, shirts	Normal	Medium			●
		Adj.				
<b>Antibacterial</b>	Do not use this cycle with delicate fabrics	Very	High	●		
<b>Perm. Press</b>	Permanent press, synthetic items	Normal	Medium	●	●	●
		Adj.				
<b>Delicates</b>	Lingerie, sheets, blouses	Normal	Low (between Medium and Ultra Low)	●	●	●
		Adj.				
<b>Towels</b>	Denim, towels, heavy cottons	Normal	Med. High (between Medium and High)	●	●	●
		Adj.				
<b>MANUAL DRY</b>						
<b>Speed Dry</b>	For small loads with short drying times	Off	High	●		●
			Adj.			
<b>Air Dry</b>	For items that require heat-free drying such as plastics or rubber	Off	No Heat	●		
<b>STEAM CYCLE</b>						
<b>Steam Sanitary™</b>	Comforters, bedding, children's clothing	Off	High	●		
<b>Steam Fresh™</b>	Comforters, shirts, trousers (except especially delicate fabrics)	Off	Med. High (between Medium and High)	●		
			Adj.			

**Steam Models (DLEX4200\*, DLGX4201\*, DLEX4500\*, DLGX4501\*)**
 = default setting

 = allowable option

\* = Energy Saver on by default

Cycle	Fabric Type	Dry Level	Temp.	Wrinkle Care	Damp Dry Signal	Reduce Static
<b>SENSOR DRY</b>						
<b>Normal*</b>	Work clothes, corduroys, etc.	Normal	Med. High (between Medium and High)	•	•	•
		Adj.				
<b>Heavy Duty</b>	Jeans, heavyweight items	Normal	High	•	•	•
		Adj.				
<b>Bedding</b>	Comforters, pillows, shirts	Normal	Medium			•
		Adj.				
<b>Small Load</b>	Only normal & cotton/towels fabric type (Max. 3 lb)	Normal	High	•		
		Adj.				
<b>Antibacterial</b>	Do not use this cycle with delicate fabrics	Very	High	•		
<b>Perm. Press</b>	Permanent press, synthetic items	Normal	Medium	•	•	•
		Adj.				
<b>Delicates</b>	Lingerie, sheets, blouses	Normal	Low (between Medium and Ultra Low)	•	•	•
		Adj.				
<b>Sportswear</b>	Sportswear	Off		•		•
<b>Towels</b>	Denim, towels, heavy cottons	Normal	Med. High (between Medium and High)	•	•	•
		Adj.				
<b>MANUAL DRY</b>						
<b>Speed Dry</b>	For small loads with short drying times	Off	High	•		•
			Adj.			
<b>Air Dry</b>	For items that require heat-free drying such as plastics or rubber	Off	No Heat	•		
<b>STEAM CYCLE</b>						
<b>Steam Sanitary™</b>	Comforters, bedding, children's clothing	Off	High	•		
<b>Steam Fresh™</b>	Comforters, shirts, trousers (except especially delicate fabrics)	Off	Med. High (between Medium and High)	•		
			Adj.			

## Cycle Modifier Buttons

Sensor Dry cycles have preset settings that are selected automatically. Manual Dry cycles have default settings, but you may also customize the settings using the cycle modifier buttons. Press the button for that option to view and select other settings.

### Dry Level

Use this button to select the level of dryness for the cycle. Press the **Dry Level** button repeatedly to scroll through available settings.

- This option is only available with Sensor Dry cycles.
- The dryer will automatically adjust the cycle time. Selecting dry levels above Normal will increase the cycle time. Selecting dry levels below Normal will decrease the cycle time.
- Use the dry level between Normal and Damp or the Damp dry level for items that you wish to iron.

### Temp.

Use this button to adjust the temperature setting. This allows precise care of fabrics and garments. Press the **Temp.** button repeatedly to scroll through available settings.

### Time Dry

Use this button to manually select the drying time, from 20 to 60 minutes, in 10-minute increments. Use this for small loads or to remove wrinkles. Use the **More Time/Less Time** buttons to add or reduce the drying time in 5-minute increments.

### Signal

The appliance plays a melody when the drying cycle is finished. The buttons make a sound each time a button is pressed. Use this button to turn the melody and button tones on or off.

(DLEX4200\*, DLGX4201\*, DLEX4000\*, DLGX4001\*, DLEX4500\*, DLGX4501\*)

- To turn on/off, press the Signal button.
- When this function is turned on, the On/Off LED on the display lights up.

(DLE3600\*, DLG3601\*)

- To turn on/off, press and hold the Wrinkle Care button for 3 seconds.

## Option Buttons

The dryer features several additional cycle options to customize cycles to meet individual needs. Certain option buttons also feature a special function that can be activated by pressing and holding that option button for 3 seconds.

### Adding Cycle Options to a Cycle

- 1 Turn on the dryer and turn the cycle selector knob to select the desired cycle.
- 2 Use the cycle modifier buttons to adjust the settings for that cycle.
- 3 Press the cycle option button(s) to add the desired options. A confirmation message is shown in the display.
- 4 Press the **Start/Pause** button to start the cycle. The dryer starts automatically.

### Wrinkle Care

Selecting this option will tumble the load periodically for up to 3 hours after the selected cycle, or until the door is opened. This is helpful in preventing wrinkles when you are unable to remove items from the dryer immediately.

### Damp Dry Signal

When this option is selected, the dryer signals when the load is approximately 80% dry. This allows you to remove faster-drying lightweight items or items that you would like to iron or hang while they are still slightly damp.

(DLEX4200\*, DLGX4201\*, DLEX4000\*, DLGX4001\*, DLEX4500\*, DLGX4501\*)

- To turn on/off, press the Damp Dry Signal button.

(DLE3600\*, DLG3601\*)

- To turn on/off, press and hold the Dry Level button for 3 seconds.

### Energy Saver

This option helps to reduce the energy consumption of the Normal Cycle, depending on the load size. When the Energy Saver option is selected, the cycle begins with an air dry section and the drying time is increased.

## Special Functions

Some cycle option buttons also activate secondary functions. These special functions are marked with an asterisk (\*). Press and hold the option button marked with the special function to activate it.

### Control Lock

Use this option to prevent unwanted use of the dryer or to keep cycle settings from being changed while the dryer is operating.

#### Activating the Control Lock Function

Press and hold the **below button(s)** for 3 seconds.

- **Damp Dry Signal** ( DLEX4200\*, DLGX4201\*, DLEX4000\*, DLGX4001\*, DLEX4500\*, DLGX4501\*)
- **Time Dry** and **Energy Saver** (DLE3600\*,DLG3601\*)

When the controls are locked, [L and the remaining time are alternately shown on the display during the dry cycle. All controls will be disabled except the Power button.

#### Deactivating the Control Lock Function

Press and hold the **below button(s)** for 3 seconds.

- **Damp Dry Signal** (DLEX4200\*, DLGX4201\*, DLEX4000\*, DLGX4001\*, DLEX4500\*, DLGX4501\*)
- **Time Dry** and **Energy Saver** (DLE3600\*,DLG3601\*)

Once set, Control Lock remains active until it is manually deactivated. Control Lock must be turned off to run another cycle.

### Drum Light

**(DLEX4200\*, DLGX4201\*,  
DLEX4000\*, DLGX4001\*,  
DLEX4500\*, DLGX4501\*)**

The drum is equipped with a blue LED that illuminates when the dryer is turned on. This light automatically turns off when the door is closed and the cycle starts. To turn on the light during a cycle, press and hold the Wrinkle Care button for three seconds. The drum light will illuminate and then turn off automatically after four minutes.

## Steam Functions (Steam Models)

LG's new steam technology injects fabrics with a swirling jet of hot steam to refresh clothes, reduce static, and make ironing easier.

Simply select the Steam Fresh™ or Steam Sanitary™ cycle, or add a steam option to selected cycles.

### WARNING

**To reduce the risk of serious injury, death, explosion, or fire, follow basic safety precautions, including the following:**

- Do not open the dryer door during steam cycles.
- Do not touch the steam nozzle in the drum during or after the steam cycle.

#### The Steam Sanitary™ Cycle

The Steam Sanitary™ cycle is ideal for sanitizing non-washable items quickly and easily using the power of steam.

Use this cycle for cotton and polyester material. (Do NOT use for urethane foam, down feathers or delicate items).

#### The Steam Fresh™ Cycle

Steam Fresh™ uses the power of steam to quickly reduce wrinkles and odors in fabrics. It brings new life to wrinkled clothes that have been stored for an extended time and makes heavily wrinkled clothes easier to iron. Steam Fresh™ can also be used to help reduce odors in fabrics.

#### NOTE

- The cycle time depends on the load (number of items). Press the **More Time** or **Less Time** button to change the display to reflect the number of items in the load. The display will show 1, 3, 5 or *b' 9*. 3 means 3 or fewer items, 5 is for 4 or 5 items, and *b' 9* indicates a large load such as a comforter.

#### Using the Steam Fresh™ Cycle

- 1 Turn on the dryer and turn the cycle selector knob to select the **Steam Fresh™** cycle.
- 2 To add an option, select **Wrinkle Care**.
- 3 The display shows the load size (number of items). Change the steam time by pressing the **More Time** or **Less Time** buttons to fit the size of the load.
- 4 Press **Start/Pause** to start the cycle.

### The Steam Options

The Reduce Static option injects steam late in the drying cycle to reduce the static electricity caused by dry fabrics rubbing together.

#### NOTE

- When Sensor Dry is selected with the Reduce Static option, the dry levels below Normal cannot be selected.
- The Reduce Static option can also be selected during Time Dry cycles.
- After the Steam option is selected in Time Dry, the **More Time or Less Time** buttons will change the steam time ONLY.
- Press the **More Time** or **Less Time** button to adjust the cycle time depending on the size of the load (7, 9, 11, 14, 16, or 18 items).

### Adding Steam to a Standard Cycle

- 1** Turn on the dryer and turn the cycle selector knob to select the desired cycle.
- 2** Use the cycle setting buttons to adjust the settings for that cycle.
- 3** Press Turbo Steam to add steam. If desired, select the Reduce Static or Wrinkle Care options. Then adjust for the load size using the More Time or Less Time buttons.
- 4** Press **Start/Pause** to start the cycle.

#### NOTE

- Steam may not be clearly visible during the steam cycles. This is normal.
- Do not use Steam Fresh™ with items such as wool, wool blankets, leather jackets, silk, wet clothes, lingerie, foam products, or electric blankets.
- For best results, load articles of similar size and fabric type. Do not overload.
- When the filter/duct is clogged, the steam option may not have optimal results.
- When the steam function is operating, the drum will stop to allow steam to stay in the drum.



## Steam Cycle Guide

☐ = default setting

● = allowable option

	Steam	Default Time	Temp.	Dry Level	Fabric State	Fabric Type	Maximum Amount
<b>Steam Sanitary™</b>	Turbo Steam	31 minutes	High		Dry	Comforter Bedding	Single (1 each)
						Children's clothing	3 lbs.
<b>Steam Fresh™</b>	Turbo Steam	10 minutes	Med. High (between Medium and High)		Dry	Comforter	Single (1 each)
			Adj.			Shirts*	5 each
<b>Steam Option</b>	Reduce Static	Follows Selected Cycle		●	Wet	Varies by selected cycle	8 lbs. (18 Items.)
	Turbo Steam	Follows Selected Cycle		●	Wet	Varies by selected cycle	8 lbs. (18 Items.)
<b>Time Dry</b>	Reduce Static	38 minutes	High		Wet	Varies by selected cycle	8 lbs. (18 Items.)
			Adj.				

\* Shirt: 70% cotton, 30% poly blend. Except especially delicate fabrics

# SMART FUNCTIONS

## LG ThinQ Application

The LG ThinQ application allows you to communicate with the appliance using a smartphone.

### Before Using LG ThinQ

- 1 Use a smartphone to check the strength of the wireless router (Wi-Fi network) near the appliance.
  - If the distance between the appliance and the wireless router is too far, the signal strength becomes weak. It may take a long time to register or installation may fail.
- 2 Turn off the **Mobile data** or **Cellular Data** on your smartphone.

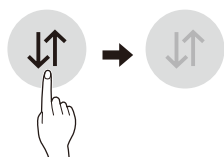

- 3 Connect your smartphone to the wireless router.

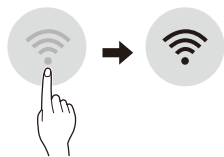

### NOTE

- To verify the Wi-Fi connection, check that **Wi-Fi**  icon on the control panel is lit.
- The appliance supports 2.4 GHz Wi-Fi networks only. To check your network frequency, contact your Internet service provider or refer to your wireless router manual.
- LG ThinQ is not responsible for any network connection problems or any faults, malfunctions, or errors caused by network connection.
- The surrounding wireless environment can make the wireless network service run slowly.

- If the appliance is having trouble connecting to the Wi-Fi network, it may be too far from the router. Purchase a Wi-Fi repeater (range extender) to improve the Wi-Fi signal strength.
- The network connection may not work properly depending on the Internet service provider.
- The Wi-Fi connection may not connect or may be interrupted because of the home network environment.
- If the appliance cannot be registered due to problems with the wireless signal transmission, unplug the appliance and wait about a minute before trying again.
- If the firewall on your wireless router is enabled, disable the firewall or add an exception to it.
- The wireless network name (SSID) should be a combination of English letters and numbers. (Do not use special characters.)
- Smartphone user interface (UI) may vary depending on the mobile operating system (OS) and the manufacturer.
- If the security protocol of the router is set to **WEP**, network setup may fail. Change the security protocol (**WPA2** is recommended), and register the product again.

### Installing the LG ThinQ Application

Search for the LG ThinQ application from the Google Play Store or Apple App Store on a smart phone. Follow instructions to download and install the application.

## LG ThinQ Application Features

### Dryer Cycle

Download new and specialized cycles that are not included in the standard cycles on the appliance.

Appliances that have been successfully connected can download a variety of specialty cycles specific to the appliance.

Only one cycle can be stored on the appliance at a time.

Once cycle download is completed in the appliance, the appliance keeps the downloaded cycle until a new cycle is downloaded.

### Venting Tips

Provides venting tips.

### Smart Diagnosis™

This function provides useful information for diagnosing and solving issues with the appliance based on the pattern of use.

### Energy Monitoring

The dryer energy usage is affected by the cycles and options, so you may see some changes in energy usage from one cycle to another.

### Push Alerts

When the cycle is complete or the appliance has problems, you have the option of receiving push notifications on a smart phone.

### Settings

Set the product nickname and delete product.

#### NOTE

- To verify the Wi-Fi connection, check that the **Wi-Fi**  icon on the control panel is lit.
- LG ThinQ is not responsible for any network connection problems or any faults, malfunctions, or errors caused by network connection.
- The machine supports 2.4 GHz Wi-Fi networks only.
- If the appliance is having trouble connecting to the Wi-Fi network, it may be too far from the router. Purchase a Wi-Fi repeater (range extender) to improve the Wi-Fi signal strength.
- The Wi-Fi connection may not connect or may be interrupted because of the home network environment.
- The network connection may not work properly depending on the internet service provider.
- The surrounding wireless environment can make the wireless network service run slowly.
- This information is current at the time of publication. The application is subject to change for product improvement purposes without notice to users.

## Using Remote Start

Use a smart phone to control the appliance remotely or check to see how much time is left in the cycle.

- 1 Press the **Power** button.
- 2 Load the laundry.
- 3 Press and hold the **Remote Start** button for 3 seconds to enable the Remote Start function.
- 4 Start a cycle from the LG ThinQ application on your smart phone.

#### NOTE

- Once the Remote Start mode is enabled, you can start a cycle from the LG ThinQ smartphone application. If the cycle is not started, the machine will wait to start the cycle until it is turned off remotely from the application or the Remote Start mode is disabled.
- If the door is opened, Remote Start is disabled.

### Disabling Remote Start

When Remote Start is activated, press and hold the **Remote Start** button for 3 seconds.

## Wireless LAN Module Specifications

<b>Model</b>	LCW-004
<b>Frequency Range</b>	2412 to 2462 MHz
<b>Output Power (Max)</b>	< 30 dBm

### FCC Notice

This equipment has been tested and found to comply with the limits for a Class B digital device, pursuant to Part 15 of the FCC Rules. These limits are designed to provide reasonable protection against harmful interference in a residential installation. This equipment generates, uses, and can radiate radio frequency energy and, if not installed and used in accordance with the instructions, may cause harmful interference to radio communications. However, there is no guarantee that interference will not occur in a particular installation. If this equipment does cause harmful interference to radio or television reception, which can be determined by turning the equipment off and on, the user is encouraged to try to correct the interference by one or more of the following measures:

- Reorient or relocate the receiving antenna.
- Increase the separation between the equipment and the receiver.
- Connect the equipment to an outlet on a circuit different from that to which the receiver is connected.
- Consult the dealer or an experienced radio/TV technician for help.

This device complies with part 15 of the FCC Rules. Operation is subject to the following two conditions:

- 1) this device may not cause harmful interference and
- 2) this device must accept any interference received, including interference that may cause undesired operation of the device.

Any changes or modifications in construction of this device which are not expressly approved by the party responsible for compliance could void the user's authority to operate the equipment.

### FCC RF Radiation Exposure Statement

This equipment complies with FCC radiation exposure limits set forth for an uncontrolled environment. This transmitter must not be co-located or operating in conjunction with any other antenna or transmitter.



This equipment should be installed and operated with a minimum distance of 20 cm (7.8 inches) between the antenna and your body. Users must follow the specific operating instructions for satisfying RF exposure compliance.

### Open Source Software Notice Information

To obtain the source code under GPL, LGPL, MPL, and other open source licenses, that is contained in this product, please visit <http://opensource.lge.com>. In addition to the source code, all referred license terms, warranty disclaimers and copyright notices are available for download.

LG Electronics will also provide open source code to you on CD-ROM for a charge covering the cost of performing such distribution (such as the cost of media, shipping, and handling) upon email request to [opensource@lge.com](mailto:opensource@lge.com). This offer is valid for three (3) years from the date on which you purchased the product.

## Smart Diagnosis™ Function

This feature is only available on models with the  or  logo.

Use this feature to help you diagnose and solve problems with your appliance.

### NOTE

- For reasons not attributable to LGE's negligence, the service may not operate due to external factors such as, but not limited to, Wi-Fi unavailability, Wi-Fi disconnection, local app store policy, or app unavailability.
- The feature may be subject to change without prior notice and may have a different form depending on where you are located.

## Using LG ThinQ to Diagnose Issues



If you experience a problem with your Wi-Fi equipped appliance, it can transmit troubleshooting data to a smartphone using the **LG ThinQ** application.

- Launch the **LG ThinQ** application and select the **Smart Diagnosis™** feature in the menu. Follow the instructions provided in the **LG ThinQ** application.

## Using Audible Diagnosis to Diagnose Issues

Follow the instructions below to use the audible diagnosis method.

- Launch the **LG ThinQ** application and select the **Smart Diagnosis™** feature in the menu. Follow the instructions for audible diagnosis provided in the **LG ThinQ** application.

- 1 Press the **Power** button to turn on the appliance.
  - Do not press any other buttons.
- 2 Hold the mouthpiece of your phone in front of the  or  logo.

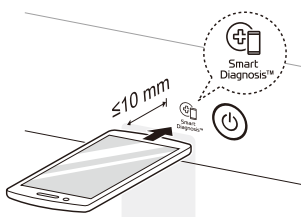

- 3 Press and hold the **Temp.** button for 3 seconds or longer while continuing to hold your phone near the logo.
- 4 Keep the phone in place until the tone transmission has finished. The display will count down the time. Once the countdown is over and the tones have stopped, the diagnosis will be displayed in the application.

### NOTE

- For best results, do not move the phone while the tones are being transmitted.

# MAINTENANCE

## Regular Cleaning

### WARNING

To reduce the risk of fire, electric shock, injury to persons, or death when using this appliance, follow basic precautions, including the following:

- Unplug the dryer before cleaning.
- Never use harsh chemicals, abrasive cleaners, or solvents to clean the washer. They will damage the finish.

### Cleaning the Exterior

Proper care of your dryer can extend its life. The outside of the machine can be cleaned with warm water and a mild, nonabrasive household detergent. Immediately wipe off any spills with a soft, damp cloth.

#### NOTE

- Do not use methylated spirits, solvents, or similar products.
- Never use steel wool or abrasive cleansers; they can damage the surface.

### Cleaning the Interior

Wipe around the door opening and seal with a soft, damp cloth to prevent lint and dust buildup that could damage the door seal.

Clean the window with a soft cloth dampened with warm water and a mild, nonabrasive household detergent, then wipe dry.

The stainless steel drum can be cleaned with a conventional stainless steel cleaner, used according to the manufacturer's specifications. Never use steel wool or abrasive cleansers; they may scratch or damage the surface.

### Cleaning Around and Under the Dryer

Vacuum lint and dust from around the dryer and underneath it regularly. Vent ductwork should be checked for lint buildup and cleaned at least once per year. If any noticeable reduction in airflow or drying performance occurs, immediately check ductwork for obstructions and blockages.

### Maintaining Ductwork

Vent ductwork should be checked for lint buildup once per month and cleaned at least once per year. If any noticeable reduction in airflow or drying performance occurs, immediately check ductwork for obstructions and blockages. Contact a qualified technician or service provider.

### Cleaning the Lint Filter

Always clean the lint from the filter after every cycle.

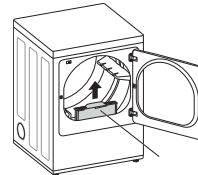

Lint Filter

To clean the lint filter, open the dryer door and pull the lint filter straight up. Then:

- 1 For everyday cleaning, roll any lint off the filter with your fingers, or

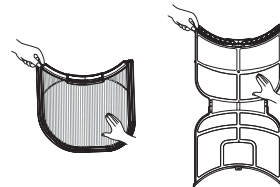

- 2 Vacuum the lint filter.

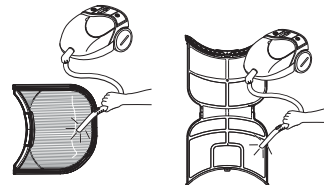

- 3 If the lint filter has become very dirty or clogged with fabric softener, wash the lint filter in warm, soapy water and allow it to dry thoroughly before reinstalling.

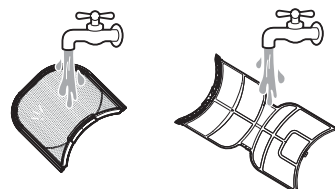

#### NOTE

- NEVER operate the dryer without the lint filter in place.

# TROUBLESHOOTING

## FAQs: Frequently Asked Questions

**Q: When I press a button, why does my dryer beep and then nothing happens?**

A: The Control Lock feature is turned on. To turn off Control Lock, turn the dryer on, then press and hold the button that has \***Control Lock** on or under it for 3 seconds.

**Q: Why does my dryer take so long to dry clothes?**

A: Proper airflow is critical to the efficient operation of clothes dryers. A lint filter which is full of lint or clogged with fabric softener sheet residue can reduce the airflow to the point that the time required to dry clothing will be greatly increased. Another factor affecting dry time is your home exhaust system. An exhaust system which is dirty and clogged with lint, or is excessively long, needs to be professionally cleaned or repaired.

**Q: Why does my dryer start by itself every few minutes?**

A: This is how the Wrinkle Care feature works. The dryer runs briefly every few minutes for up to 3 hours after the cycle finishes. This feature is designed to help prevent wrinkles from setting in when the dryer is not unloaded immediately after the cycle is finished.

**Q: Why does my dryer show 3 minutes when I select the Steam Fresh™ cycle?**

A: When the Steam Fresh™ cycle is selected, the dryer displays the recommended number of garments for the cycle, not the estimated cycle time, until the cycle is started. Use the **More Time or Less Time** buttons to adjust the load size setting for the number of garments you desire. For a large load or single bulky item use the *b' 9* (big) setting.

## User Support Videos

For further assistance, there are videos and tutorials available through the LG.com website.

- 1 On the lg.com/us home page, click on the Support menu tab to bring up the menu selections. Select **Video Tutorials**.
- 2 Type **Dryer** in the search box on the new page and click the Search button.



Scan this QR code to quickly access the video search page on the LG website.

## Before Calling for Service

This dryer is equipped with an automatic error-monitoring system to detect and diagnose problems at an early stage. If the dryer does not function properly or does not function at all, check the following before you call for service.

### Operation

Problem	Possible Cause	Solutions
The Flow Sense™ indicator remains active after clearing the restriction in the venting.	After clearing the restriction, the Flow Sense™ system requires multiple, consecutive cycles to determine that the performance value has improved before the Flow Sense™ indicator is reset.	<ul style="list-style-type: none"> <li>• If the Flow Sense™ indicator remains active for more than five cycles after the restriction has been cleared, call for service.</li> </ul>
Dryer will not turn on	Power cord is not properly plugged in.	<ul style="list-style-type: none"> <li>• Make sure that the plug is securely plugged into a grounded outlet matching the dryer's rating plate.</li> </ul>
	House fuse is blown, circuit breaker has tripped, or power outage has occurred.	<ul style="list-style-type: none"> <li>• Reset circuit breaker or replace fuse. Do not increase fuse capacity. If the problem is a circuit overload, have it corrected by a qualified electrician.</li> </ul>
Dryer does not heat	House fuse is blown, circuit breaker has tripped, or power outage has occurred.	<ul style="list-style-type: none"> <li>• Reset circuit breaker or replace fuse. Do not increase fuse capacity. If the problem is a circuit overload, have it corrected by a qualified electrician.</li> <li>• NOTE: Due to the design of electric dryers, it is possible for a circuit problem to allow an electric dryer to run without heat.</li> </ul>
	Gas supply or service is turned off.	<ul style="list-style-type: none"> <li>• Confirm that the house gas shutoff and the dryer gas shutoff valves are both fully open. Even if gas is not supplied to the dryer, it will run and no error codes will display. Verify that other gas appliances in the home are working normally.</li> </ul>
	ENERGY SAVER option selected (on some models)	<ul style="list-style-type: none"> <li>• If using the Normal cycle, deselect the ENERGY SAVER option. The Energy Saver option is selected by default. This option reduces energy use by adding an air dry section to the beginning of the cycle. It is normal to feel no heat at the beginning of the cycle while in ENERGY SAVER mode.</li> </ul>
Clothes take too long to dry	Exhaust ducts are blocked, dirty, or duct run is too long.	<ul style="list-style-type: none"> <li>• Confirm that the exhaust duct is properly configured and free of debris, lint, and obstructions. Make sure that outside wall dampers can open properly and are not blocked, jammed, or damaged.</li> </ul>
	Load is not properly sorted.	<ul style="list-style-type: none"> <li>• Separate heavy items from lightweight items. Larger and heavier items take longer to dry. Light items in a load with heavy items can fool the sensor because the light items dry faster.</li> </ul>
Display shows error code nP	Electric dryer power cord is not connected correctly, or house power supply is incorrect.	<ul style="list-style-type: none"> <li>• Check the power supply or the connection of the power cord to the terminal block.</li> </ul>
Display shows error code gAS	Gas supply or service turned off (gas models only).	<ul style="list-style-type: none"> <li>• Confirm that house gas shutoff and the dryer gas shutoff are both fully open.</li> </ul>



Problem	Possible Cause	Solutions
<b>Clothes take too long to dry</b>	<b>Large load of heavy fabrics.</b>	<ul style="list-style-type: none"> <li>• Heavy fabrics take longer to dry because they tend to retain more moisture. To help reduce and maintain more consistent drying times for large and heavy fabrics, separate these items into smaller loads of a consistent size.</li> </ul>
	<b>Dryer controls are not set properly.</b>	<ul style="list-style-type: none"> <li>• Use the appropriate control settings for the type of load you are drying. Some loads may require an adjustment of the dry level setting for proper drying.</li> </ul>
	<b>Lint filter needs to be cleaned.</b>	<ul style="list-style-type: none"> <li>• Remove the lint from the filter before every load. With the lint removed, hold the filter up to a light to see if it is dirty or clogged. With some loads that produce high amounts of lint, such as new bath towels, it may be necessary to pause the cycle and clean the filter during the cycle.</li> </ul>
	<b>House fuse is blown, circuit breaker has tripped, or power outage has occurred.</b>	<ul style="list-style-type: none"> <li>• Reset circuit breaker or replace fuse. Do not increase fuse capacity. If the problem is a circuit overload, have it corrected by a qualified electrician.</li> <li>• NOTE: Due to the design of electric dryers, it is possible for a circuit problem to allow an electric dryer to run without heat.</li> </ul>
	<b>Dryer is overloaded.</b>	<ul style="list-style-type: none"> <li>• Divide extra large loads into smaller loads for better drying performance and efficiency.</li> </ul>
	<b>Dryer is underloaded.</b>	<ul style="list-style-type: none"> <li>• If you are drying a very small load, add a few extra items to ensure proper tumbling action. If the load is very small and you are using SENSOR DRY cycles, the electronic control cannot properly sense the dryness of the load and may shut off too soon. Use TIME DRY or add some extra wet clothes to the load.</li> </ul>
	<b>ENERGY SAVER option selected (on some models)</b>	<ul style="list-style-type: none"> <li>• If using the Normal cycle, deselect the ENERGY SAVER option. This option reduces energy use by adding an air dry section to the beginning of the cycle.</li> </ul>
<b>Drying time is not consistent</b>	<b>Heat settings, load size, or dampness of clothing is not consistent.</b>	<ul style="list-style-type: none"> <li>• The drying time for a load will vary depending on the type of heat used (electric, natural gas, or LP gas), the size of the load, the type of fabrics, the wetness of the clothes, and the condition of the exhaust duct and lint filter. Even an unbalanced load in the washer can cause poor spinning, resulting in wetter clothes which will take longer to dry.</li> </ul>

## Performance

Problem	Possible Cause	Solutions
Greasy or dirty spots on clothes	Fabric softener used incorrectly.	<ul style="list-style-type: none"> <li>Confirm and follow the instructions provided with your fabric softener.</li> </ul>
	Clean and dirty clothes are being dried together.	<ul style="list-style-type: none"> <li>Use your dryer to dry only clean items. Soil from dirty clothes can transfer to the clean clothes in the same or later loads.</li> </ul>
	Clothes were not properly cleaned or rinsed before being placed in the dryer.	<ul style="list-style-type: none"> <li>Stains on dried clothes could be stains that were not removed during the washing process. Make sure that clothes are being completely cleaned or rinsed according to the instructions for your washer and detergent. Some difficult soils may require pre-treating prior to washing.</li> </ul>
Clothes are wrinkled	Clothes dried too long (over dried).	<ul style="list-style-type: none"> <li>Over drying a load of laundry can lead to wrinkled clothes. Try a shorter drying time or LESS DRY setting and remove items while they still retain a slight amount of moisture.</li> </ul>
	Clothes left in dryer too long after cycle ends.	<ul style="list-style-type: none"> <li>Use the WRINKLE CARE option. This feature will tumble the clothes briefly every few minutes for up to 3 hours to help prevent wrinkling.</li> </ul>
Clothes are shrinking	Garment care instructions are not being followed.	<ul style="list-style-type: none"> <li>To avoid shrinking your clothes, always consult and follow fabric care instructions. Some fabrics will naturally shrink when washed. Other fabrics can be washed but will shrink when dried in a dryer. Use a low or no heat setting.</li> </ul>
Lint on clothes	Lint filter not cleaned properly.	<ul style="list-style-type: none"> <li>Remove the lint from the filter before every load. With the lint removed, hold the filter up to a light to see if it is dirty or clogged. If it looks dirty, follow the cleaning instructions. With some loads that produce high amounts of lint, it may be necessary to clean the filter during the cycle.</li> </ul>
	Laundry not sorted properly.	<ul style="list-style-type: none"> <li>Some fabrics are lint producers (i.e., a fuzzy white cotton towel) and should be dried separately from clothes that are lint trappers (i.e., a pair of black linen pants).</li> </ul>
	Excess static in clothes.	<ul style="list-style-type: none"> <li>Use a fabric softener to reduce static electricity. Be sure to follow the manufacturer's instructions. Overdrying a load of laundry can cause a buildup of static electricity. Adjust settings and use a shorter drying time, or use SENSOR DRY cycles.</li> </ul>
	Dryer is overloaded.	<ul style="list-style-type: none"> <li>Divide extra large loads into smaller loads for drying.</li> </ul>
	Tissue, paper, etc., left in pockets.	<ul style="list-style-type: none"> <li>Check pockets thoroughly before washing and drying clothes.</li> </ul>

Problem	Possible Cause	Solutions
<b>Excess static in clothes after drying</b>	<b>Fabric softener is not used or used incorrectly.</b>	<ul style="list-style-type: none"> <li>• Use a fabric softener or the REDUCE STATIC option, if equipped, to reduce static electricity. Be sure to follow the manufacturer's instructions.</li> </ul>
	<b>Clothes dried too long (overdried).</b>	<ul style="list-style-type: none"> <li>• Overdrying a load of laundry can cause a buildup of static electricity. Adjust settings and use a shorter drying time, or use MANUAL DRY cycles. Select a LESS DRY setting on SENSOR DRY cycles, if necessary.</li> </ul>
	<b>Drying synthetics, permanent press, or synthetic blends.</b>	<ul style="list-style-type: none"> <li>• These fabrics are naturally more prone to static buildup. Try using fabric softener, or use LESS DRY and/or shorter TIME DRY time settings.</li> </ul>
<b>Clothes have damp spots after a Sensor Dry cycle.</b>	<b>Very large load or very small load. Single large item such as a blanket or comforter.</b>	<ul style="list-style-type: none"> <li>• If items are too tightly packed or too sparse the sensor may have trouble reading the dryness level of the load. Use a TIME DRY cycle for very small loads.</li> <li>• Large, bulky items such as blankets or comforters can sometimes wrap themselves into a tight ball of fabric. The outside layers will dry and register on the sensors, while the inner core remains damp. When drying a single bulky item, it may help to pause the cycle once or twice and rearrange the item to unwrap and expose any damp areas.</li> <li>• To dry a few remaining damp items from a very large load or a few damp spots on a large item after a sensor cycle has completed, empty the lint trap, then set a TIME DRY cycle to finish drying the item(s).</li> </ul>
<b>Trouble connecting appliance and smartphone to Wi-Fi network</b>	<b>The password for the Wi-Fi network was entered incorrectly.</b>	<ul style="list-style-type: none"> <li>• Delete your home Wi-Fi network and begin the registration process again.</li> </ul>
	<b>Mobile data for your smartphone is turned on.</b>	<ul style="list-style-type: none"> <li>• Turn off the Mobile data on your smartphone before registering the appliance.</li> </ul>
	<b>The wireless network name (SSID) is set incorrectly.</b>	<ul style="list-style-type: none"> <li>• The wireless network name (SSID) should be a combination of English letters and numbers. (Do not use special characters.)</li> </ul>
	<b>The router frequency is not 2.4 GHz.</b>	<ul style="list-style-type: none"> <li>• Only a 2.4 GHz router frequency is supported. Set the wireless router to 2.4 GHz and connect the appliance to the wireless router. To check the router frequency, check with your Internet service provider or the router manufacturer.</li> </ul>
	<b>The appliance is too far from the router.</b>	<ul style="list-style-type: none"> <li>• If the appliance is too far from the router, the signal may be weak and the connection may not be configured correctly. Move the router closer to the appliance or purchase and install a Wi-Fi repeater.</li> </ul>

## Steam Functions (Steam Models)

Problem	Possible Cause	Solutions
Water drips from nozzle when STEAM CYCLE starts	This is normal.	<ul style="list-style-type: none"> <li>This is steam condensation. The dripping water will stop after a short time.</li> </ul>
Garments still wrinkled after Steam Fresh™	Too many or overly different types of garments in dryer.	<ul style="list-style-type: none"> <li>Small loads of 1 to 5 items work best. Load fewer garments. Load similar types of garments.</li> </ul>
Creases or pleats are gone from garments after Steam Fresh™	The function of this cycle is to remove wrinkles from fabric.	<ul style="list-style-type: none"> <li>Use an iron to replace creases and pleats in garments.</li> </ul>
Garments have static after using the Reduce Static option	This is normal.	<ul style="list-style-type: none"> <li>The amount of static experienced will depend on the individual moisture level in the skin.</li> </ul>
Garments are too damp or too dry after using the Reduce Static option	Correct drying options not selected.	<ul style="list-style-type: none"> <li>Select the load weight manually before starting the Reduce Static option.</li> </ul>
Steam does not generate, but no error code is shown	Water level error.	<ul style="list-style-type: none"> <li>Unplug dryer and call for service.</li> </ul>
Water drips from door during STEAM CYCLE	This is normal.	<ul style="list-style-type: none"> <li>Condensation will normally form on the inside of the dryer door during steam operation. Some condensation may drip out the bottom of the door.</li> </ul>
Steam is not visible during STEAM CYCLE	This is normal.	<ul style="list-style-type: none"> <li>Steam vapor is difficult to see when the door is closed. However, condensation will normally form on the inside of the dryer door if the steam system is operating normally.</li> </ul>
Drum does not turn during STEAM CYCLE	This is normal.	<ul style="list-style-type: none"> <li>The drum is turned off so that the steam vapor remains in the drum. The drum will normally turn for about 2 seconds once a minute.</li> </ul>
Cannot see steam vapor at the beginning of cycle	This is normal.	<ul style="list-style-type: none"> <li>Steam is released at different stages of the cycle for each option.</li> </ul>
Odors remain in clothing after Steam Fresh™	Steam Fresh™ did not remove odor completely.	<ul style="list-style-type: none"> <li>Fabrics containing strong odors should be washed in a normal cycle.</li> </ul>

## Error Codes

Problem	Possible Cause	Solutions
Error code: tE1 through tE7	Temperature sensor failure.	<ul style="list-style-type: none"> <li>• Turn off the dryer and call for service.</li> </ul>
Display shows error code: PS	Power cord is connected incorrectly.	<ul style="list-style-type: none"> <li>• Check the connection of the power cord to the terminal block.</li> </ul>
<p>*Flow Sense™ indicator shows four bars during the drying cycle or the display shows "d80" after drying</p> <p>* This warning light is not a dryer failure and is not covered by the dryer warranty. Contact a duct cleaning service to set up an appointment to have your exhaust system cleaned and inspected.</p>	Exhaust system is too long or has too many turns/restrictions.	<ul style="list-style-type: none"> <li>• Install a shorter or straighter duct run. See the Installation Instructions for details.</li> </ul>
	Partial blockage of the ductwork due to lint buildup or other foreign object.	<ul style="list-style-type: none"> <li>• Ductwork should be checked/cleaned immediately. Dryer can be used in this condition, but drying times will be longer and energy consumption will increase.</li> </ul>
	The appliance has detected a restriction in the external dryer venting.	<ul style="list-style-type: none"> <li>• If exhaust restrictions are sensed by the Flow Sense™ system, the indicator will remain on for 2 hours after the end of the cycle. Opening the door or pressing the Power button will turn off the display.</li> </ul>
The Flow Sense™ indicator remains active after clearing the restriction in the venting.	After clearing the restriction, the Flow Sense™ system requires multiple, consecutive cycles to determine that the performance value has improved before the Flow Sense™ indicator is reset.	<ul style="list-style-type: none"> <li>• If the Flow Sense™ indicator remains active for more than five cycles after the restriction has been cleared, call for service.</li> </ul>
The display shows <i>b19</i>	More Time button was pressed.	<ul style="list-style-type: none"> <li>• This display indicates that the steam option has been set for a "big" item such as a comforter. Press the LESS TIME button to reduce the indicated load size.</li> </ul>
<p>The display shows</p> 	The duct work is about 80% - 95% blocked. ("d80", "d90" or "d95" error code is displayed for 2 hours only)	<ul style="list-style-type: none"> <li>• Do not use the dryer until the exhaust system has been cleaned and/or repaired. Using the dryer with a severely restricted exhaust is dangerous and could result in a fire or other property damage. Check the outside dryer vent while the dryer is operating to make sure there is strong airflow. If the exhaust system is extremely long, have it repaired or rerouted.</li> </ul>
	House exhaust system blocked.	<ul style="list-style-type: none"> <li>• Keep the area around the dryer clean and free of clutter. Check vent hood for damage or lint clogging. Make sure the area around the vent hood is clear.</li> </ul>
Check Filter indicator is on during the drying cycle	Lint filter not cleaned properly.	<ul style="list-style-type: none"> <li>• Remove the lint from the filter before every load. With the lint removed, hold the filter up to a light to see if it is dirty or clogged. If it looks dirty, follow the cleaning instructions. With some loads that produce high amounts of lint, it may be necessary to clean the filter during the cycle.</li> </ul>

# WARRANTY

ARBITRATION NOTICE: THIS LIMITED WARRANTY CONTAINS AN ARBITRATION PROVISION THAT REQUIRES YOU AND LG TO RESOLVE DISPUTES BY BINDING ARBITRATION INSTEAD OF IN COURT, UNLESS YOU CHOOSE TO OPT OUT. IN ARBITRATION, CLASS ACTIONS AND JURY TRIALS ARE NOT PERMITTED. PLEASE SEE THE SECTION TITLED "PROCEDURE FOR RESOLVING DISPUTES" BELOW.

Should your LG Dryer ("Product") fail due to a defect in materials or workmanship under normal home use, during the warranty period set forth below, LG will at its option repair or replace the product. This limited warranty is valid only to the original retail purchaser of the product and applies only when purchased and used within the United States including U.S. Territories. Proof of original retail purchase is required to obtain warranty service under this limited warranty.

Warranty Period	Scope of Warranty	HOW SERVICE IS HANDLED
One (1) year from date of original retail purchase	Parts and Labor	LG will provide parts and labor to repair or replace defective parts.
Three (3) years from date of original retail purchase	Dryer drum	Parts only. Customer will be responsible for any labor or in-home service to replace defective parts.

- Replacement products and parts are warranted for the remaining portion of the original warranty period or ninety (90) days, whichever is greater.
- Replacement products and parts may be new or remanufactured.

**THIS WARRANTY IS IN LIEU OF ANY OTHER WARRANTY, EXPRESS OR IMPLIED, INCLUDING WITHOUT LIMITATION, ANY WARRANTY OF MERCHANTABILITY OR FITNESS FOR A PARTICULAR PURPOSE. TO THE EXTENT ANY IMPLIED WARRANTY IS REQUIRED BY LAW, IT IS LIMITED IN DURATION TO THE EXPRESS WARRANTY PERIOD ABOVE. NEITHER THE MANUFACTURER NOR ITS U.S. DISTRIBUTOR SHALL BE LIABLE FOR ANY INCIDENTAL, CONSEQUENTIAL, INDIRECT, SPECIAL, OR PUNITIVE DAMAGES OF ANY NATURE, INCLUDING WITHOUT LIMITATION, LOST REVENUES OR PROFITS, OR ANY OTHER DAMAGE WHETHER BASED IN CONTRACT, TORT, OR OTHERWISE.**

Some states do not allow the exclusion or limitation of incidental or consequential damages or limitations on how long an implied warranty lasts, so the above exclusion or limitation may not apply to you. This warranty gives you specific legal rights and you may also have other rights that vary from state to state.

## **THIS LIMITED WARRANTY DOES NOT COVER:**

- Service trips to deliver, pick up, or install or repair the product; instruction to the customer on operation of the product; repair or replacement of fuses or correction of wiring or plumbing, or correction of unauthorized repairs/installation.
- Failure of the product to perform during power failures and interrupted or inadequate electrical service.
- Damage caused by leaky or broken water pipes, frozen water pipes, restricted drain lines, inadequate or interrupted water supply or inadequate supply of air.
- Damage resulting from operating the product in a corrosive atmosphere or contrary to the instructions outlined in the product's owner's manual.
- Damage to the product caused by accidents, pests and vermin, lightning, wind, fire, floods, or acts of God.
- Damage or failure caused by unauthorized modification or alteration, or if it is used for other than the intended purpose, or any water leakage where the unit was not properly installed.
- Damage or failure caused by incorrect electrical current, voltage, or plumbing codes, commercial or industrial use, or use of accessories, components, or consumable cleaning products that are not approved by LG.
- Damage caused by transportation and handling, including scratches, dents, chips, and/or other damage to the finish of your product, unless such damage results from defects in materials or workmanship and is reported within one (1) week of delivery.
- Damage or missing items to any display, open box, discounted, or refurbished product.
- Conversion of product from natural gas or LP gas.

- Products with original serial numbers that have been removed, altered, or cannot be readily determined. Model and serial numbers, along with original retail sales receipts, are required for warranty validation.
- Increases in utility costs and additional utility expenses.
- Repairs when your product is used for other than normal and usual household use (e.g. commercial use, in offices and recreational facilities) or contrary to the instructions outlined in the product's owner's manual.
- Costs associated with removal of your product from your home for repairs.
- The removal and reinstallation of the product if it is installed in an inaccessible location or is not installed in accordance with published installation instructions, including LG's owner's and installation manuals.
- Damage resulting from misuse, abuse, improper installation, repair, or maintenance. Improper repair includes use of parts not approved or specified by LG.

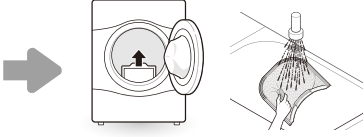
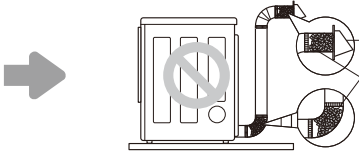
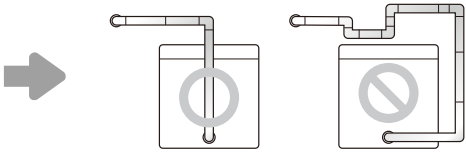
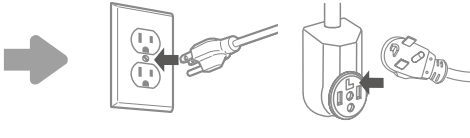
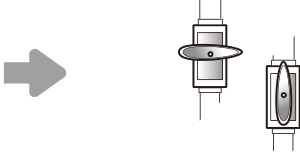
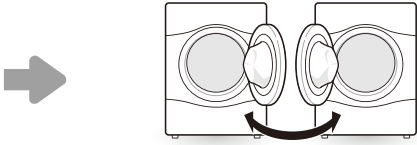
<p><b>Filter is clogged.</b></p> <p>Not heating, long dry time</p>		<p><b>Clean the lint filter.</b></p>
<p>Duct is clogged.</p> <p>Not heating, long dry time</p>		<p>Clean the hood and duct.</p>
<p>Excessive duct length and/or multiple elbows</p> <p>Not heating, long dry time</p>		<p>Keep exhaust ducts as short as possible, using as few elbows and bends as possible.</p>
<p>Improperly connected power cord or electrical outlet issue.</p> <p>No Power</p> <p>Not Heating</p>		<p>Reconnect power cord, replace house fuse or reset breaker. If outlet is issue, electrician may be required.</p>
<p>Gas valve is not turned on. (Gas Dryer)</p> <p>Not heating</p>		<p>Open the gas valve.</p>
<p>Door Reversal</p>		<p>Instructions for door reversal can be found in the owner's manual.</p>

**The cost of repair or replacement under these excluded circumstances shall be borne by the consumer.**

TO OBTAIN WARRANTY SERVICE AND ADDITIONAL INFORMATION

For additional product information, visit the LG website at <http://www.lg.com>

For assistance using this product or to schedule service, contact LG Electronics at 1-800-243-0000.

For further assistance, write: LG Electronics, 201 James Record Road, Huntsville, Alabama 35813



**PROCEDURE FOR RESOLVING DISPUTES:**

ALL DISPUTES BETWEEN YOU AND LG ARISING OUT OF OR RELATING IN ANY WAY TO THIS LIMITED WARRANTY OR THE PRODUCT SHALL BE RESOLVED EXCLUSIVELY THROUGH BINDING ARBITRATION, AND NOT IN A COURT OF GENERAL JURISDICTION. BINDING ARBITRATION MEANS THAT YOU AND LG ARE EACH WAIVING THE RIGHT TO A JURY TRIAL AND TO BRING OR PARTICIPATE IN A CLASS ACTION.

Definitions. For the purposes of this section, references to “LG” mean LG Electronics U.S.A., Inc., its parents, subsidiaries and affiliates, and each of their officers, directors, employees, agents, beneficiaries, predecessors in interest, successors, assigns and suppliers; references to “dispute” or “claim” shall include any dispute, claim or controversy of any kind whatsoever (whether based in contract, tort, statute, regulation, ordinance, fraud, misrepresentation or any other legal or equitable theory) arising out of or relating in any way to the sale, condition or performance of the product or this Limited Warranty.

Notice of Dispute. In the event you intend to commence an arbitration proceeding, you must first notify LG in writing at least 30 days in advance of initiating the arbitration by sending a letter to LG at LG Electronics, USA, Inc. Attn: Legal Department- Arbitration 111 Sylvan Ave, Englewood Cliffs, NJ 07632. You and LG agree to engage in good faith discussions in an attempt to amicably resolve your claim. The notice must provide your name, address, and telephone number; identify the product that is the subject of the claim; and describe the nature of the claim and the relief being sought. If you and LG are unable to resolve the dispute within 30 days, either party may proceed to file a claim for arbitration.

Agreement to Binding Arbitration and Class Action Waiver. Upon failure to resolve the dispute during the 30 day period after sending written notice to LG, you and LG agree to resolve any claims between us only by binding arbitration on an individual basis, unless you opt out as provided below. Any dispute between you and LG shall not be combined or consolidated with a dispute involving any other person’s or entity’s product or claim. More specifically, without limitation of the foregoing, any dispute between you and LG shall not under any circumstances proceed as part of a class or representative action. Instead of arbitration, either party may bring an individual action in small claims court, but that small claims court action may not be brought on a class or representative basis.

Arbitration Rules and Procedures. To begin arbitration of a claim, either you or LG must make a written demand for arbitration. The arbitration will be administered by the American Arbitration Association (“AAA”) and will be conducted before a single arbitrator under the AAA’s Consumer Arbitration Rules that are in effect at the time the arbitration is initiated (referred to as the “AAA Rules”) and under the procedures set forth in this section. The AAA Rules are available online at [www.adr.org/consumer](http://www.adr.org/consumer). Send a copy of your written demand for arbitration, as well as a copy of this provision, to the AAA in the manner described in the AAA Rules. You must also send a copy of your written demand to LG at LG Electronics, USA, Inc. Attn: Legal Department- Arbitration 111 Sylvan Avenue, Englewood Cliffs, NJ 07632. If there is a conflict between the AAA Rules and the rules set forth in this section, the rules set forth in this section will govern. This arbitration provision is governed by the Federal Arbitration Act. Judgment may be entered on the arbitrator’s award in any court of competent jurisdiction. All issues are for the arbitrator to decide, except that issues relating to the scope and enforceability of the arbitration provision and to the arbitrability of the dispute are for the court to decide. The arbitrator is bound by the terms of this provision.

Governing Law. The law of the state of your residence shall govern this Limited Warranty and any disputes between us except to the extent that such law is preempted by or inconsistent with applicable federal law.

Fees/Costs. You do not need to pay any fee to begin an arbitration. Upon receipt of your written demand for arbitration, LG will promptly pay all arbitration filing fees to the AAA unless you seek more than \$25,000 in damages, in which case the payment of these fees will be governed by the AAA Rules. Except as otherwise provided for herein, LG will pay all AAA filing, administration and arbitrator fees for any arbitration initiated in accordance with the AAA Rules and this arbitration provision. If you prevail in the arbitration, LG will pay your attorneys’ fees and expenses as long as they are reasonable, by considering factors including, but not limited to, the purchase amount and claim amount. Notwithstanding the foregoing, if applicable law allows for an award of reasonable attorneys’ fees and expenses, an arbitrator can award them to the same extent that a court would. If the arbitrator finds either the substance of your claim or the relief sought in the demand is frivolous or brought for an improper purpose (as measured by the standards set forth in Federal Rule of Civil Procedure 11(b)), then the payment of all arbitration fees will be governed by the AAA Rules. In such a situation, you agree to reimburse LG for all monies previously disbursed by it that are otherwise your obligation to pay under the AAA Rules. Except as otherwise provided for, LG waives any rights it may have to seek attorneys’ fees and expenses from you if LG prevails in the arbitration.



Hearings and Location. If your claim is for \$25,000 or less, you may choose to have the arbitration conducted solely on the basis of (1) documents submitted to the arbitrator, (2) through a telephonic hearing, or (3) by an in-person hearing as established by the AAA Rules. If your claim exceeds \$25,000, the right to a hearing will be determined by the AAA Rules. Any in-person arbitration hearings will be held at a location within the federal judicial district in which you reside unless we both agree to another location or we agree to a telephonic arbitration.

Opt Out. You may opt out of this dispute resolution procedure. If you opt out, neither you nor LG can require the other to participate in an arbitration proceeding. To opt out, you must send notice to LG no later than 30 calendar days from the date of the first consumer purchaser's purchase of the product by either: (i) sending an e-mail to [optout@lge.com](mailto:optout@lge.com), with the subject line: "Arbitration Opt Out" or (ii) calling 1-800-980-2973. You must include in the opt out e-mail or provide by telephone: (a) your name and address; (b) the date on which the product was purchased; (c) the product model name or model number; and (d) the serial number (the serial number can be found (i) on the product; or (ii) online by accessing <https://www.lg.com/us/support/repair-service/schedule-repair-continued> and clicking on "Find My Model & Serial Number").

You may only opt out of the dispute resolution procedure in the manner described above (that is, by e-mail or telephone); no other form of notice will be effective to opt out of this dispute resolution procedure. Opting out of this dispute resolution procedure will not affect the coverage of the Limited Warranty in any way, and you will continue to enjoy the full benefits of the Limited Warranty. If you keep this product and do not opt out, then you accept all terms and conditions of the arbitration provision described above.







