

OWNER'S MANUAL

AIR CONDITIONER

Please read this manual carefully before operating your set and retain it for future reference.

CONSOLE



MFL67870345
Rev.01_061120

www.lghvac.com
www.lg.com

Copyright © 2020 LG Electronics Inc. All Rights Reserved.

TABLE OF CONTENTS

3 Safety Instructions

7 Electrical Safety

- 7 Temporary Use of an Adapter
- 7 Temporary Use of an Extension Cord

8 Product Introduction

- 8 Indoor Unit
- 8 Operation Indication Lamps

9 Preparation Before Operation

- 9 How to insert the Batteries
- 9 Wireless Remote Controller Maintenance
- 9 Operating Method
- 10 Wireless Remote Controller
- 11 Setting the Current Time
- 11 Air Flow Selection
- 11 Turn the breaker ON
- 11 Tips for Saving Energy

12 Operating Instructions

- 12 Operation Mode
- 13 Auto Changeover Operation (Single Model Only)
- 13 Auto Operation
- 13 Healthy Dehumidification Operation
- 14 Air Circulation Operation
- 14 Auto Clean Operation
- 14 Energy-Saving Cooling Mode
- 14 Display Temperature Unit
- 15 Timer Setting
- 15 To cancel the timer setting
- 15 Sleep Mode Operation
- 16 Upper Horizontal Vane Control
- 16 Selecting air outlet direction
- 17 Jet Mode Operation
- 17 Forced operation
- 18 Auto Restart Function
- 18 Filter Sign

19 Maintenance and Service

- 19 Indoor Unit
- 20 Outdoor Unit
- 20 Operation Tips!
- 20 Self-Diagnosis Function
- 21 Troubleshooting Tips! Save time and money!
- 21 Call the service immediately in the following situations

22 WARRANTY (USA)

24 WARRANTY (CANADA)

Safety Instructions

The following safety guidelines are intended to prevent unforeseen risks or damage from unsafe or incorrect operation of the appliance.

The guidelines are separated into 'WARNING' and 'CAUTION' as described below.

-  This symbol is displayed to indicate matters and operations that can cause risk.
Read the part with this symbol carefully and follow the instructions in order to avoid risk.

WARNING

This indicates that the failure to follow the instructions can cause serious injury or death.

CAUTION

This indicates that the failure to follow the instructions can cause the minor injury or damage to the product.

WARNING

- Do not use a defective or underrated circuit breaker. Use the correctly rated breaker and fuse.
 - There is risk of fire or electric shock .
- Do not use a multi consent. Always use this appliance on a dedicated circuit breaker.
 - Otherwise it can cause electric shock or fire.
- For electrical work, contact the dealer, seller, a qualified electrician, or an Authorized Service Center. Do not disassemble or repair the product by yourself.
 - There is risk of fire or electric shock.
- Always ground the product as per the wiring diagram. Do not connect the ground wire to gas or water pipes lightning rod or telephone ground wire.
 - There is risk of fire or electric shock.
- Install the panel and the cover of control box securely.
 - There is risk of fire or electric shock due to dust , water etc.
- Use the correctly rated breaker or fuse.
 - There is risk of fire or electric shock.
- Do not modify or extend the power cable. If the power cable or cord has scratches or skin peeled off or deteriorated then it must be replaced.
 - There is risk of fire or electric shock.
- For installation, removal or reinstall , always contact the dealer or an Authorized Service Center.
 - There is risk of fire, electric shock, explosion, or injury.
- Do not install the product on a defective installation stand. Be sure that the installation area does not deteriorate with age.
 - It may cause product to fall.
- Never install the outdoor unit on a moving base or a place from where it can fall down.
 - The falling outdoor unit can cause damage or injury or even death of a person.
- When the product is soaked (flooded or submerged) in water , contact an Authorized Service Center for repair before using it again.
 - There is risk of fire or electric shock.
- In outdoor unit the step-up capacitor supplies high voltage electricity to the electrical components. Be sure to discharge the capacitor completely before conducting the repair work.
 - An charged capacitor can cause electrical shock.

Safety Instructions

- When installing the unit, use the installation kit provided with the product.
 - Otherwise the unit may fall and cause severe injury.
- Be sure to use only those parts which are listed in the svc parts list. Never attempt to modify the equipment.
 - The use of inappropriate parts can cause an electrical shock, excessive heat generation or fire.
- Indoor/outdoor wiring connections must be secured tightly and the cable should be routed properly so that there is no force pulling the cable from the connection terminals.
 - Improper or loose connections can cause heat generation or fire.
- Safely dispose off the packing materials. Like screws, nails, batteries, broken things etc after installation or svc and then tear away and throw away the plastic packaging bags.
 - Children may play with them and cause injury.
- Be sure to check the refrigerant to be used. Please read the label on the product.
 - Incorrect refrigerant used can prevent the normal operation of the unit.
- Do not touch, operate, or repair the product with wet hands.
 - There is risk of electric shock or fire.
- Do not place a heater or other heating appliances near the power cable.
 - There is risk of fire and electric shock.
- Do not allow water to run into electric parts. Install the unit away from water sources.
 - There is risk of fire, failure of the product, or electric shock.
- Do not store or use or even allow flammable gas or combustibles near the product.
 - There is risk of fire.
- Do not use the product in a tightly closed space for a long time. Perform ventilation regularly.
 - Oxygen deficiency could occur and hence harm your health.
- Do not open the front grille of the product during operation.
 - There is risk of physical injury, electric shock, or product failure.
- If strange sound, smell or smoke comes from product. Immediately turn the breaker off or disconnect the power supply cable.
 - There is risk of electric shock or fire.
- Ventilate the product room from time to time when operating it together with a stove, or heating element etc.
 - Oxygen deficiency can occur and hence harm your health.
- Turn off the power and the circuit breaker when cleaning or repairing the product.
 - There is risk of electric shock.
- When the product is not to be used for a long time, turn off the circuit breaker.
 - There is risk of product damage or failure, or unintended operation.
- Take care to ensure that nobody especially kids could step on or fall onto the outdoor unit.
 - This could result in personal injury and product damage.
- Take care to ensure that power cable could not be pulled out or damaged during operation.
 - There is risk of fire or electric shock.
- Do not place anything on the power cable.
 - There is risk of fire or electric shock.
- When flammable gas leaks, turn off the gas and open a window for ventilation before turning on the product.
 - Do not use the telephone or turn switches on or off. There is risk of explosion or fire.

⚠ CAUTION

- Two or more people must lift and transport the product.
 - Avoid personal injury.
- Do not install the product where it will be exposed to sea wind (salt spray) directly.
 - It may cause corrosion on the product.
- Install the drain hose to ensure that the condensed water is drained away properly.
 - A bad connection may cause water leakage.
- Keep level even when installing the product.
 - To avoid vibration or noise.
- Do not install the product where the noise or hot air from the outdoor unit could damage or disturb the neighborhoods.
 - It may cause a problem for your neighbors and hence dispute.
- Always check for gas (refrigerant) leakage after installation or repair of product.
 - Low refrigerant levels may cause failure of product.
- Do not use the product for special purposes, such as preserving foods, works of art, etc. It is a consumer air conditioner, not a precision refrigeration system.
 - There is risk of damage or loss of property.
- Do not block the inlet or outlet of air flow.
 - It may cause product failure.
- Use a soft cloth to clean. Do not use harsh detergents, solvents or splashing water etc.
 - There is risk of fire, electric shock, or damage to the plastic parts of the product.
- Do not touch the metal parts of the product when removing the air filter.
 - There is risk of personal injury.
- Do not step on or put anything on the product. (outdoor units)
 - There is risk of personal injury and failure of product.
- Always insert the filter securely after cleaning. Clean the filter every two weeks or more often if necessary.
 - A dirty filter reduces the efficiency.
- Do not insert hands or other objects through the air inlet or outlet while the product is operating.
 - There are sharp and moving parts that could cause personal injury.
- Be cautious when unpacking and installing the product.
 - Sharp edges could cause injury.
- If the refrigerant gas leaks during the repair, do not touch the leaking refrigerant gas.
 - The refrigerant gas can cause frostbite (cold burn)
- Do not tilt the unit when removing or uninstalling it.
 - The condensed water inside can spill .
- Do not mix air or gas other than the specified refrigerant used in the system .
 - If air enters the refrigerant system, an excessively high pressure results, causing equipment damage or injury.
- If the refrigerant gas leaks during the installation, ventilate the area immediately.
 - Otherwise it can be harmful for your health.
- Dismantling the unit, treatment of the refrigerant oil and eventual parts should be done in accordance with local and national standards. Replace the all batteries in the remote control with new ones of the same type. Do not mix old and new batteries or different types of batteries.
 - There is risk of fire or product failure.
- Do not recharge or disassemble the batteries. Do not dispose off batteries in a fire.
 - They may burn or explode.
- If the liquid from the batteries gets onto your skin or clothes, wash it well with clean water. Do not use the remote if the batteries have leaked.
 - The chemicals in batteries could cause burns or other health hazards.

Safety Instructions

- If you eat the liquid from the batteries, brush your teeth and see doctor. Do not use the remote if the batteries have leaked.
 - The chemicals in batteries could cause burns or other health hazards.
- Do not let the air conditioner run for a long time when the humidity is very high and a door or a window is left open.
 - Moisture may condense and wet or damage furniture.
- Do not expose your skin or kids or plants to the cool or hot air draft.
 - This could harm to your health.
- Do not drink the water drained from the product.
 - It is not sanitary and could cause serious health issues.
- Use a firm stool or ladder when cleaning, maintaining or repairing the product at an height.
 - Be careful and avoid personal injury.
- Do not sit or step on the indoor unit
 - It may cause product failure.
- This appliance is not intended for use by persons (including children) with reduced physical, sensory or mental capabilities, or lack of experience and knowledge unless they have been given supervision or instruction concerning use of the appliance by a person responsible for their safety.
 - Children should be supervised to ensure that they do not play with the appliance.
- The Limited Warranty is void and of no effect, and LG will have no liability hereunder to any Customer or third party, to the extent any of the following occur: acts, omissions, and conduct of any and all third parties including, but not limited to, the installing contractor and any repairs, service or maintenance by unauthorized or unqualified persons.
- Do not install the unit in potentially explosive atmospheres.

Electrical Safety

WARNING

- This appliance must be properly grounded. There is a risk of electric shock.
- Attaching the adapter ground terminal to the wall receptacle cover screw does not ground the appliance unless the cover screw is metal and not insulated, and the wall receptacle is grounded through the house wiring.
- If you have any doubt whether the air conditioner is properly grounded, have the wall receptacle and circuit checked by a qualified electrician.
- The Power cord connected to the unit should be selected according to the following specifications.

Temporary Use of an Adapter

We strongly discourage the use of an adapter due to potential safety hazards. For temporary connections, use only a genuine adapter, available from most local hardware stores. Ensure that the large slot in the adapter is aligned with the large slot in the receptacle for a proper polarity connection.

To disconnect the power cord from the adapter, use one hand on each to avoid damaging the ground terminal. Avoid frequently unplugging the power cord as this can lead to eventual ground terminal damage.

WARNING

- Never use the appliance with a broken adapter.

Temporary Use of an Extension Cord

We strongly discourage the use of an extension cord due to potential safety hazards.

WARNING

This appliance should be installed in accordance with national wiring regulations. This manual acts as a guide to explaining product features.

Product Introduction

Indoor Unit

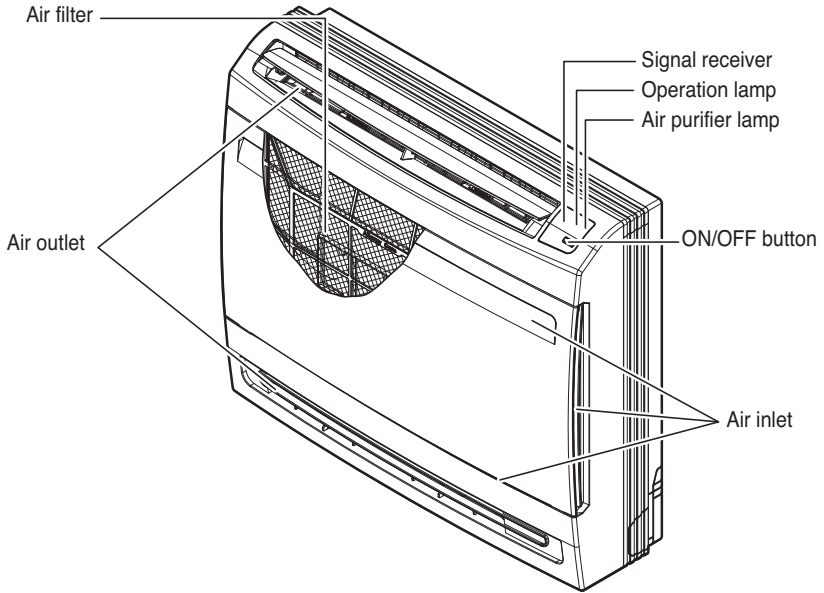

Operation Indication Lamps

- Operation lamp :
'Blue' lights up during Cooling / Healthy Dehumidification / Air Circulation Operation.
'Red' lights up during Heating Operation.
- Air purifier lamp :
'Green' lights up during Air Purifier Operation.

Preparation Before Operation

How to insert the Batteries

1. Remove the battery cover by pulling it according to the arrow direction.
2. Insert new batteries making sure that the (+) and (-) of battery are installed correctly.
3. Reattach the cover by sliding it back into position.

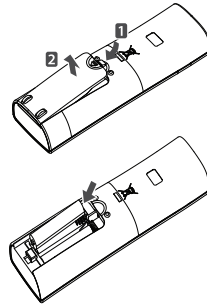

NOTE

1. Always use/replace both batteries of same type.
2. If the system is not to be used for a long time, remove the batteries to save their working life.
3. If the display screen of remote controller starts, fading replace both of the batteries.
4. Use 2 AAA(1.5 volt) batteries.

Wireless Remote Controller Maintenance

1. Choose a suitable place where its safe & easy to reach.
2. Fix the holder to wall etc with the supplied screws firmly.
3. Slide the remote controller inside the holder.

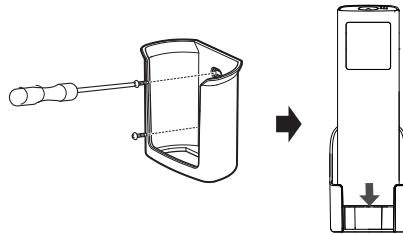

NOTE

1. Remote controller should never be exposed to direct sunlight.
2. Signal transmitter & receiver should always be clean for proper communication. Use a soft cloth to clean them.
3. In case some other appliances also get operated with remote control, change their position or consult your serviceman.

Operating Method

1. The signal receiver is inside the unit.
2. Aim the remote controller towards the unit to operate it. There should not be any blockage in between.

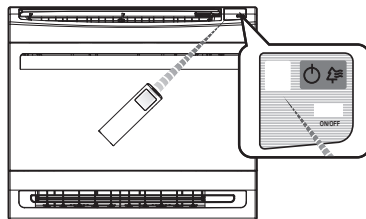

Wireless Remote Controller

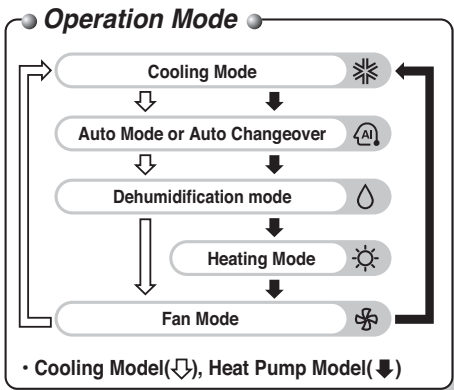
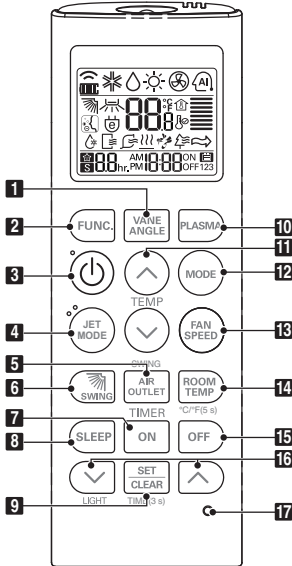

- 1 VANE ANGLE Button**
Used to set each vane angle.
- 2 FUNCTION SETTING Button**
Used to set or clear Auto Clean, Smart Clean, Electric heater or Individual vane angle control.
- 3 ON/OFF Button**
Used to turn on/off the unit.
- 4 JET MODE Button**
JET MODE sets the fan to operate at a super high speed.
- 5 AIR OUTLET Button**
Used to select airflow direction
- 6 UP/DOWN AIRFLOW Button**
Used to stop or start louver movement and set the desired up/down airflow direction.
- 7 ON TIMER Button**
Used to set the time of starting operation.
- 8 SLEEP TIMER Button**
Used to set the time of sleeping operation.
- 9 SET / CLEAR Button**
Used to set/clear the timer.
Used to set the current time(if it input for 3sec.)
- 10 PLASMA Button (OPTIONAL)**
Used to start or stop the plasma-purification function.
- 11 ROOM TEMPERATURE SETTING Button**
Used to select the room temperature.
- 12 OPERATION MODE SELECTION Button**
Used to select the operation mode.
- 13 INDOOR FAN SPEED SELECTION Button**
Used to select fan speed in four steps low, medium, high and chaos.
- 14 ROOM TEMPERATURE CHECKING Button**
Used to check the room temperature.
- 15 OFF TIMER Button**
Used to set the time of stopping operation.
- 16 TIMER SETTING(Up/Down)/LIGHT Button**
Used to set the timer.
Used to adjust the brightness.(if it is not time adjust mode)
- 17 RESET Button**
Used to reset the remote controller.

Setting the Current Time

1. Press the SET / CLEAN button for 3 seconds.



2. Press TIME SETTING buttons until the desired time is set. (If you press down the button for a long time, it will change quickly in the units of 10 min.)

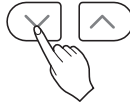

3. Press the SET / CLEAR button.



NOTE

Check the indicator for A.M. and P.M.

Air Flow Selection

- Make air flow selection according to what suits you.
- 2 Vane Mode will automatically change blowing pattern depending on the operating mode & situation.

Operating Mode	Situation	Blowing Pattern
Cooling Mode	1. When the room has become fully cool. 2. When 1 hour has passed since turning on the air conditioner.	Using only upper air outlet.
	1. At start of operation or other times when the room is not fully cooled.	Using upper & lower air outlet.
Heating Mode	1. Normal Operation	Using only upper is outlet.
	1. At start or when air temperature is low.	

⚠ CAUTION

- If you want to change air flow mode, you ask to installer. (Default is 2 Vane Mode)

Turn the breaker ON

Turning on the breaker closes the flap. (This is a normal procedure)

Tips for Saving Energy

- Be careful not to cool (heat) the room too much. Keeping the temperature setting at a moderate level helps save energy.
- Cover windows with a blind or a curtain.
Blocking sunlight and air from outdoors increases the cooling (heating) effect.
- Clogged air filters cause inefficient operation and waste energy.
Clean them once in about every two weeks.

Operating Instructions

Operation Mode

- 1** Press the ON/OFF button to turn the unit on.
The unit will respond with a beep.



- 2** Open the cover of the remote controller and press the OPERATION MODE button. Each time the button is pressed, the operation mode is shifted in the direction of the arrow.

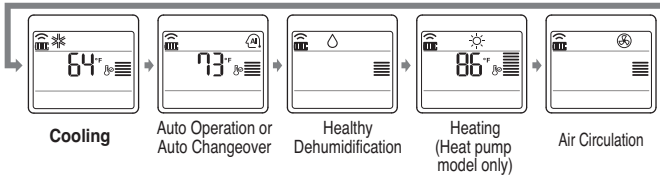

- 3** For cooling or heating operation set the desired indoor temperature by pressing the Temperature adjustment buttons.
For cooling the temperature can be set within 16°C~30°C(60°F~86°F) and for heating the temperature range is 16°C~30°C(60°F~86°F).



- 4** Set the fan speed with the remote controller. You can select the fan speed in five steps; Super low, Low, Medium, High and Natural wind by pressing the FAN SPEED button.
Each time the button is pressed, the fan speed mode is shifted in the direction of the arrow.



Natural wind

- For fresher feeling, press the FAN SPEED button and set to Natural wind mode.
In this mode, the wind blows like a natural breeze by automatically changing fan speed.

Auto Changeover Operation (Single Model Only)

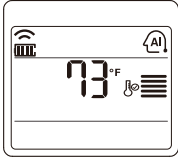

This operation is basically heating or cooling function of the air conditioner. But during this operation the controller changes the operation mode automatically to keep the temperature within $\pm 2^{\circ}\text{C}$ (4°F) with respect to the setting temperature.



Auto Operation

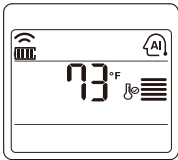

This operations automatically selects cooling mode or heating mode based on the room temperature. You can set desired temperature and indoor fan speed. But operation mode will be decided by that of the room with the first unit to be turned on.



Healthy Dehumidification Operation

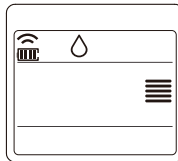

If you select the dehumidification mode on the OPERATION MODE SELECTION button, the product starts to run the dehumidification function. It automatically sets the room temperature and the fan speed to the best condition for dehumidification, based on the Sensed current room temperature. During this operation, the fan speed is automatically set according to the optimization algorithm responding to the current room temperature status, so that the room condition is kept healthy and comfortable even in very humid season.



NOTE

In this case, the setting temperature is not displayed on the remote controller and you are not able to control the room temperature either.

Air Circulation Operation





This operation circulates the air without cooling or heating. It can be activated by pressing the OPERATION MODE SELECTION button. Once the air circulation is activated you can select the fan speed by pressing the FAN SPEED button.

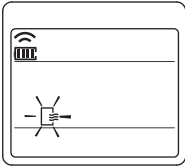

NOTE : During this operation, Operation lamp 'Blue' lights up.

Auto Clean Operation



Select Auto Clean Operation by the function setting button(). Now whenever the unit is turned off, the indoor fan is still running for about 15 minutes internally without cooling or dehumidification operation. This function dries up any remains of moisture & cleans the unit internally. If you push the Auto Clean button again, this function is cancelled.



NOTE

- During Auto Clean function, only ON/OFF button, PURIFIER button, AUTO CLEAN button is used. During this operation, Operation Lamp 'Blue' lights up and blink.

Energy-Saving Cooling Mode

Energy-saving cooling mode can save energy in cooling operation, because it can operate efficiently by setting body-adaptation time according to the change of time and temperature and adjusting desired temperature automatically.



Energy Saving Cooling Mode operation can be started by pressing the ENERGY SAVING COOLING MODE button on the remote controller.

Repressing it will deactivate the operation.

Display Temperature Unit

This function allows switching the display between Celsius and Fahrenheit temperature unit.



Timer Setting

1. Press ON or OFF button.  
2. Press Time Setting buttons until the desired time is set.  
3. Press the Set/Clear button. 

To cancel the timer setting

- If you wish to cancel all timer setting, press the Set/clear button.
- In order to cancel the timer settings individually, press the Timer button to select Reserved 'On' or Reserved 'Off'. And then press the Set/Clear button aiming the remote controller at the signal receiver. (the timer lamp on the display will go off)

Sleep Mode Operation

Press the SLEEP MODE AUTO button to set the time when you want the unit to stop automatically. The timer is programmed in one-hour increments by pressing the SLEEP MODE AUTO button 1 to 7 times. The sleep mode is available for 1 to 7 hours.



NOTE

- The sleep mode will operate indoor fan at super low speed in cooling mode and at low speed in heating mode for pleasant sleep.
- **In cooling mode or healthy dehumidification mode:**
The setting temperature will rise automatically two times by 1°C(2°F) over next consecutive 30 minutes (Maximum 2°C(4°F)) for a comfortable sleep. This will be the final setting temperature as long as sleep mode is functioning.

Upper Horizontal Vane Control

The Upper Horizontal Vane can be adjusted by using the remote controller.

1. Press the ON/OFF button to start the unit.
2. Press the UPPER HORIZONTAL VANE CONTROL button.

Each time the button is pressed, the air-flow direction is changed in the direction of the arrow.

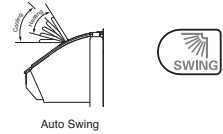

Wireless Remote Controller



Indoor Unit

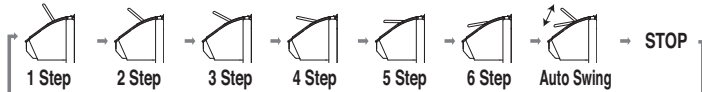

※ Press the UPPER HORIZONTAL VANE CONTROL button once more during Auto Swing at the direction of airflow you want.

NOTE

- Manually moving the Upper Horizontal Vane by hand could damage the mechanism. When the unit is shut off, the the Upper Horizontal Vane will close the air outlet vent of the product.
- ※ When you restart the unit, Upper Horizontal Vane will be located as you selected before.

Selecting air outlet direction

You can select the air outlet.

1. Press ON/OFF button to start the unit.
2. Press the AIR OUTLET button.



- If is selected, only upper air outlet will be opened and blow air.
- If is selected, only lower air outlet will be opened and blow air.
- If is selected, upper/lower air outlets will be opened and blow air.

Jet Mode Operation

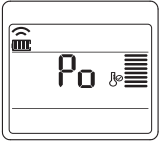

The unit will operate in super high fan speed in jet mode. To cancel the JET Mode press the JET Mode button or the FAN SPEED button or the room temperature setting button again and the unit will operate in high fan speed in heating mode.



Forced operation

Forced operation is used when the remote controller can't be used. The operation will be started if the ON/OFF button is pressed. If you want to stop the operation, re-press the button.

NOTE

- LED is turned on, off after 1 or 2 s, when you push the ON/OFF button.

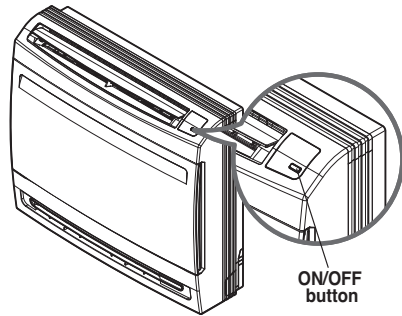

	Cooling Model	Heat pump Model		
		Room Temp. $\geq 24^{\circ}\text{C}(75^{\circ}\text{F})$	$21^{\circ}\text{C}(70^{\circ}\text{F}) \leq$ Room Temp. $< 24^{\circ}\text{C}(75^{\circ}\text{F})$	Room Temp. $< 21^{\circ}\text{C}(70^{\circ}\text{F})$
Operating mode	Cooling	Cooling	Healthy Dehumidification	Heating
Indoor FAN Speed	High	High	High	High
Setting Temperature	$22^{\circ}\text{C}(72^{\circ}\text{F})$	$22^{\circ}\text{C}(72^{\circ}\text{F})$	$23^{\circ}\text{C}(73^{\circ}\text{F})$	$24^{\circ}\text{C}(75^{\circ}\text{F})$

Test operation

During the TEST OPERATION, the unit operates in cooling mode at high speed fan, regardless of room temperature and resets in 18 minutes. During test operation, if remote controller signal is received, the unit operates as remote controller sets. If you want to use this operation, **Press and hold the ON/OFF button for 3~5 seconds**, then the buzzer sound 1 'beep'. If you want to stop the operation, re-press the button.

Auto Restart Function

This function is useful in the situation of power failure. When power regains after a failure this feature restore the previous operating condition and the air conditioner will run in the same settings.

Filter Sign

- When Indoor Unit is OFF, Operation lamp 'Green' lights up after 2400 hours from the time of first operation of the unit.
- When filter is covered by dust, it will reduce cooling/ heating efficiency and accumulate more electric power. Therefore, do clean the filter whenever cleaning time is expired.
- Remove the Filter Sign
After cleaning the filter, Press the  button of remote controller 3 times. Then the Filter sign is turned off.

Maintenance and Service

⚠ CAUTION

Before performing any maintenance, turn off the main power to the system, disconnect the circuit breaker.

Indoor Unit

Clean the unit with a soft dry cloth. Do not use bleach or abrasives.

⚠ CAUTION

Never use any of these:

- Water hotter than 40°C(104°F). It may cause deformation and discoloration.
- Volatile substances. They may damage the surface of the air conditioner.

Air Filters

The air filters behind the front panel / grille should be checked and cleaned once in every 2 weeks or more often if necessary. To remove the filters see the self explanatory diagrams below. Clean the filters with a vacuum cleaner or warm soapy water. If dirt is not easily removed, wash with a solution of detergent in luke warm water. Dry well in shade after washing and reinstall the filters back in place.

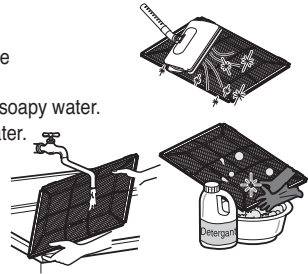

Removal of Grille

1. Open the front grille by pulling forward
2. Then pull out the link of grille from groove in front panel.
3. Then pull out 2 hinges of grille from grooves in front panel.

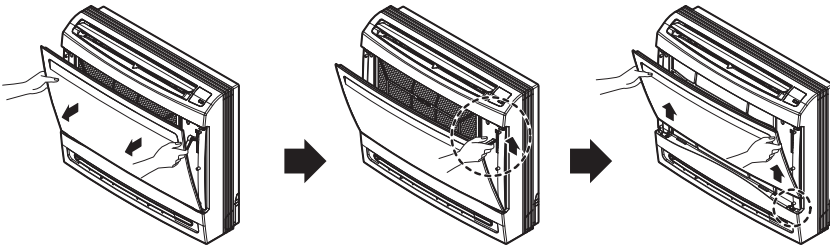

Removal of Filters

- Pull down the filter tab slightly to remove the air filter.

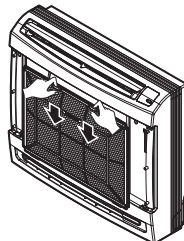

Outdoor Unit

The heat exchanger coils and panel vents of the outdoor unit should be checked regularly. If clogged with dirt or soot, the heat exchanger and panel vents may be professionally steam cleaned.

NOTE

Dirty or clogged coils will reduce the operating efficiency of the system and cause higher operating costs.

Operation Tips!

- Do not overcool the room.
 - This is not good for the health and wastes electricity.
- Keep blinds or curtains closed.
 - Do not let direct sunshine enter the room when the air conditioner is in operation.
- Keep the room temperature uniform.
 - Adjust the vertical and horizontal airflow direction to ensure a uniform temperature in the room.
- Make sure that the doors and windows are shut tight.
 - Avoid opening doors and windows as much as possible to keep the cool air in the room.
- Clean the air filter regularly.
 - Blockages in the air filter reduce the airflow and lower cooling and dehumidifying effects. Clean at least once every two weeks.
- Ventilate the room occasionally.
 - Since windows are kept closed, it is a good idea to open them and ventilate the room now and then.
- Use high fan speed for effective and fast cooling.
 - The unit gives its rated cooling capacity when the fan speed is high.
- Avoid spilling water or milk at the top of the indoor unit.
 - It may cause product failure.
- Be cautious when your children are opening the inlet Grille Because it is locked by magnetic type.
 - Sharp edges could cause injury.

Self-Diagnosis Function

This unit has an inbuilt error diagnosis capability. Error is displayed by 'RED' Operation Lamp. Please contact your serviceman/dealer in such a situation.

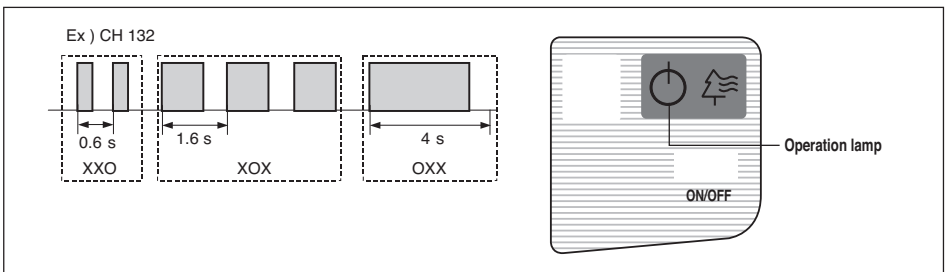

Troubleshooting Tips! Save time and money!

The air conditioner may be operating abnormally when:

Problem	Possible Causes	What To Do
Air conditioner does not start.	■ The fuse is blown/circuit breaker is tripped.	• Check the house fuse/circuit breaker box and replace the fuse or reset the breaker.
	■ Power failure.	• If power failure occurs, turn the mode control to OFF. When power is restored, wait 3 minutes to restart the air conditioner to prevent tripping of the compressor overload.
	■ High voltage.	• If the voltage is unusually very high or low the circuit Breaker will trip.
Air conditioner does not cool as it should.	■ Airflow is restricted.	• Make sure there are no curtains, blinds, or furniture blocking the front of the air conditioner.
	■ The air filter is dirty.	• Clean the filter at least every 2 weeks. See the Maintenance and Service section.
	■ The room may have been hot.	• When the air conditioner is first turned on, you need to allow time for the room to cool down.
	■ Cold air is escaping.	• Check for open furnace floor registers and cold air returns.
	■ Check the temperature settings.	• Make sure they are correct.
	■ There might be any heating source in the room.	• Check and remove such source or turn it off while using the air conditioner.

Call the service immediately in the following situations

1. Anything abnormal such as burning smell, loud noise etc. happen. Stop the unit and turn the breaker off. Never try to repair by yourself or restart the system in such cases.
2. Connecting wire is too hot or damaged.
3. Error code is generated by self diagnosis.
4. Water leaks from indoor unit even if the humidity is low.
5. Any switch, breaker (safety, earth) or fuse fails to work properly.

User must carry routine checkup & cleaning to avoid unit's poor performance. In case of special situation, the job must be carried out by service person only.

WARRANTY (USA)

ARBITRATION NOTICE: THIS LIMITED WARRANTY CONTAINS AN ARBITRATION PROVISION THAT REQUIRES YOU AND LG TO RESOLVE DISPUTES BY BINDING ARBITRATION INSTEAD OF IN COURT, UNLESS YOU CHOOSE TO OPT OUT. IN ARBITRATION, CLASS ACTIONS AND JURY TRIALS ARE NOT PERMITTED. PLEASE SEE THE SECTION TITLED “PROCEDURE FOR RESOLVING DISPUTES” BELOW.

PROCEDURE FOR RESOLVING DISPUTES:

ALL DISPUTES BETWEEN YOU AND LG ARISING OUT OF OR RELATING IN ANY WAY TO THIS LIMITED WARRANTY OR THE PRODUCT SHALL BE RESOLVED EXCLUSIVELY THROUGH BINDING ARBITRATION, AND NOT IN A COURT OF GENERAL JURISDICTION. BINDING ARBITRATION MEANS THAT YOU AND LG ARE EACH WAIVING THE RIGHT TO A JURY TRIAL AND TO BRING OR PARTICIPATE IN A CLASS ACTION.

Definitions. For the purposes of this section, references to “LG” mean LG Electronics U.S.A., Inc., its parents, subsidiaries and affiliates, and each of their officers, directors, employees, agents, beneficiaries, predecessors in interest, successors, assigns and suppliers; references to “dispute” or “claim” shall include any dispute, claim or controversy of any kind whatsoever (whether based in contract, tort, statute, regulation, ordinance, fraud, misrepresentation or any other legal or equitable theory) arising out of or relating in any way to the sale, condition or performance of the product or this Limited Warranty.

Notice of Dispute. In the event you intend to commence an arbitration proceeding, you must first notify LG in writing at least 30 days in advance of initiating the arbitration by sending a letter to LG at LG Electronics, USA, Inc. Attn: Legal Department- Arbitration 111 Sylvan Avenue, Englewood Cliffs, NJ 07632. You and LG agree to engage in good faith discussions in an attempt to amicably resolve your claim. The notice must provide your name, address, and telephone number; identify the product that is the subject of the claim; and describe the nature of the claim and the relief being sought. If you and LG are unable to resolve the dispute within 30 days, either party may proceed to file a claim for arbitration.

Agreement to Binding Arbitration and Class Action Waiver. Upon failure to resolve the dispute during the 30 day period after sending written notice to LG, you and LG agree to resolve any claims between us only by binding arbitration on an individual basis, unless you opt out as provided below. Any dispute between you and LG shall not be combined or consolidated with a dispute involving any other person’s or entity’s product or claim. More specifically, without limitation of the foregoing, any dispute between you and LG shall not under any circumstances proceed as part of a class or representative action. Instead of arbitration, either party may bring an individual action in small claims court, but that small claims court action may not be brought on a class or representative basis.

Arbitration Rules and Procedures. To begin arbitration of a claim, either you or LG must make a written demand for arbitration. The arbitration will be administered by the American Arbitration Association (“AAA”) and will be conducted before a single arbitrator under the AAA’s Consumer Arbitration Rules that are in effect at the time the arbitration is initiated (referred to as the “AAA Rules”) and under the procedures set forth in this section. The AAA Rules are available online at www.adr.org/consumer. Send a copy of your written demand for arbitration, as well as a copy of this provision, to the AAA in the manner described in the AAA Rules. You must also send a copy of your written demand to LG at LG Electronics, USA, Inc. Attn: Legal Department- Arbitration 111 Sylvan Avenue, Englewood Cliffs, NJ 07632.

If there is a conflict between the AAA Rules and the rules set forth in this section, the rules set forth in this section will govern. This arbitration provision is governed by the Federal Arbitration Act. Judgment may be entered on the arbitrator’s award in any court of competent jurisdiction. All issues are for the arbitrator to decide, except that issues relating to the scope and enforceability of the

arbitration provision and to the arbitrability of the dispute are for the court to decide. The arbitrator is bound by the terms of this provision.

Governing Law. The law of the state of your residence shall govern this Limited Warranty and any disputes between us except to the extent that such law is preempted by or inconsistent with applicable federal law.

Fees/Costs. You do not need to pay any fee to begin an arbitration. Upon receipt of your written demand for arbitration, LG will promptly pay all arbitration filing fees to the AAA unless you seek more than \$25,000 in damages, in which case the payment of these fees will be governed by the AAA Rules. Except as otherwise provided for herein, LG will pay all AAA filing, administration and arbitrator fees for any arbitration initiated in accordance with the AAA Rules and this arbitration provision. If you prevail in the arbitration, LG will pay your attorneys' fees and expenses as long as they are reasonable, by considering factors including, but not limited to, the purchase amount and claim amount. Notwithstanding the foregoing, if applicable law allows for an award of reasonable attorneys' fees and expenses, an arbitrator can award them to the same extent that a court would. If the arbitrator finds either the substance of your claim or the relief sought in the demand is frivolous or brought for an improper purpose (as measured by the standards set forth in Federal Rule of Civil Procedure 11(b)), then the payment of all arbitration fees will be governed by the AAA Rules. In such a situation, you agree to reimburse LG for all monies previously disbursed by it that are otherwise your obligation to pay under the AAA Rules. Except as otherwise provided for, LG waives any rights it may have to seek attorneys' fees and expenses from you if LG prevails in the arbitration.

Hearings and Location. If your claim is for \$25 000 or less, you may choose to have the arbitration conducted solely on the basis of (1) documents submitted to the arbitrator, (2) through a telephonic hearing, or (3) by an in-person hearing as established by the AAA Rules. If your claim exceeds \$25 000, the right to a hearing will be determined by the AAA Rules. Any in-person arbitration hearings will be held at a location within the federal judicial district in which you reside unless we both agree to another location or we agree to a telephonic arbitration.

Opt Out. You may opt out of this dispute resolution procedure. If you opt out, neither you nor LG can require the other to participate in an arbitration proceeding. To opt out, you must send notice to LG no later than 30 calendar days from the date of the first consumer purchaser's purchase of the product by either: (i) sending an e-mail to optout@lge.com, with the subject line: "Arbitration Opt Out" or (ii) calling 1-800-980-2973. You must include in the opt out e-mail or provide by telephone: (a) your name and address; (b) the date on which the product was purchased; (c) the product model name or model number; and (d) the serial number (the serial number can be found (i) on the product; or (ii) online by accessing <https://www.lg.com/us/support/repair-service/schedule-repair-continued> and clicking on "Find My Model & Serial Number").

You may only opt out of the dispute resolution procedure in the manner described above (that is, by e-mail or telephone); no other form of notice will be effective to opt out of this dispute resolution procedure. Opting out of this dispute resolution procedure will not affect the coverage of the Limited Warranty in any way, and you will continue to enjoy the full benefits of the Limited Warranty. If you keep this product and do not opt out, then you accept all terms and conditions of the arbitration provision described above.

WARRANTY (CANADA)

ARBITRATION NOTICE: THIS LIMITED WARRANTY CONTAINS AN ARBITRATION PROVISION THAT REQUIRES YOU AND LG TO RESOLVE DISPUTES BY BINDING ARBITRATION INSTEAD OF IN COURT, UNLESS THE LAWS OF YOUR PROVINCE OR TERRITORY DO NOT PERMIT THAT, OR, IN OTHER JURISDICTIONS, IF YOU CHOOSE TO OPT OUT. IN ARBITRATION, CLASS ACTIONS AND JURY TRIALS ARE NOT PERMITTED. PLEASE SEE THE SECTION TITLED "PROCEDURE FOR RESOLVING DISPUTES" BELOW.

PROCEDURE FOR RESOLVING DISPUTES:

EXCEPT WHERE PROHIBITED AT LAW, ALL DISPUTES BETWEEN YOU AND LG ARISING OUT OF OR RELATING IN ANY WAY TO THIS LIMITED WARRANTY OR THE PRODUCT SHALL BE RESOLVED EXCLUSIVELY THROUGH BINDING ARBITRATION, AND NOT IN A COURT OF GENERAL JURISDICTION. EXCEPT WHERE PROHIBITED AT LAW, YOU AND LG BOTH IRREVOCABLY AGREE TO WAIVE THE RIGHT TO A JURY TRIAL AND TO BRING OR PARTICIPATE IN A CLASS ACTION.

Definitions. For the purposes of this section, references to "LG" mean LG Electronics Canada, Inc., its parents, subsidiaries and affiliates, and each of their officers, directors, employees, agents, beneficiaries, predecessors in interest, successors, assigns and suppliers; references to "dispute" or "claim" shall include any dispute, claim or controversy of any kind whatsoever (whether based in contract, tort, statute, regulation, ordinance, fraud, misrepresentation or any other legal or equitable theory) arising out of or relating in any way to the sale, condition or performance of the product or this Limited Warranty.

Notice of Dispute. In the event you intend to commence an arbitration proceeding, you must first notify LG in writing at least 30 days in advance of initiating the arbitration by sending a letter to LGECI Legal Team at 20 Norelco Drive, North York, Ontario, Canada M9L 2X6 (the "Notice of Dispute"). You and LG agree to engage in good faith discussions in an attempt to amicably resolve your claim. The notice must provide your name, address, and telephone number; identify the product that is the subject of the claim; and describe the nature of the claim and the relief being sought. If you and LG are unable to resolve the dispute within 30 days of LG's receipt of the Notice of Dispute, the dispute shall be resolved by binding arbitration in accordance with the procedure set out herein. You and LG both agree that, during the arbitration proceeding, the terms (including any amount) of any settlement offer made by either you or LG will not be disclosed to the arbitrator until the arbitrator determines the dispute.

Agreement to Binding Arbitration and Class Action Waiver. Upon failure to resolve the dispute during the 30 day period after LG's receipt of the Notice of Dispute, you and LG agree to resolve any claims between you and LG only by binding arbitration on an individual basis, unless you opt out as provided below, or you reside in a jurisdiction that prevents full application of this clause in the circumstances of the claims at issue (in which case if you are a consumer, this clause will only apply if you expressly agree to the arbitration). To the extent permitted by applicable law, any dispute between you and LG shall not be combined or consolidated with a dispute involving any other person's or entity's product or claim. More specifically, without limitation of the foregoing, except to the extent such a prohibition is not permitted at law, any dispute between you and LG shall not under any circumstances proceed as part of a class or representative action. Instead of arbitration, either party may bring an individual action in small claims court, but that small claims court action may not be brought on a class or representative basis except to the extent this prohibition is not permitted at law in your province or territory of jurisdiction as it relates to the claims at issue between you and LG.

Arbitration Rules and Procedures. To begin arbitration of a claim, either you or LG must make a written demand for arbitration. The arbitration will be private and confidential, and conducted on a simplified and expedited basis before a single arbitrator chosen by the parties under the provincial or

territorial commercial arbitration law and rules of the province or territory of your residence. You must also send a copy of your written demand to LG at LG Electronics, Canada, Inc., Attn: Legal Department- Arbitration, 20 Norelco Drive, North York, Ontario M9L 2X6. This arbitration provision is governed by your applicable provincial or territorial commercial arbitration legislation. Judgment may be entered on the arbitrator's award in any court of competent jurisdiction. All issues are for the arbitrator to decide, except that, issues relating to the scope and enforceability of the arbitration provision and to the arbitrability of the dispute are for the court to decide. The arbitrator is bound by the terms of this provision.

Governing Law. The law of the province or territory of your purchase shall govern this Limited Warranty and any disputes between you and LG except to the extent that such law is preempted by or inconsistent with applicable federal or provincial/territorial law. Should arbitration not be permitted for any claim, action, dispute or controversy between you and LG, you and LG attorn to the exclusive jurisdiction of the courts of the province or territory of your purchase for the resolution of the claim, action, dispute or controversy between you and LG.

Fees/Costs. You do not need to pay any fee to begin an arbitration. Upon receipt of your written demand for arbitration, LG will promptly pay all arbitration filing fees unless you seek more than \$25 000 in damages, in which case the payment of these fees will be governed by the applicable arbitration rules. Except as otherwise provided for herein, LG will pay all filing, administration and arbitrator fees for any arbitration initiated in accordance with the applicable arbitration rules and this arbitration provision. If you prevail in the arbitration, LG will pay your attorneys' fees and expenses as long as they are reasonable, by considering factors including, but not limited to, the purchase amount and claim amount. Notwithstanding the foregoing, if applicable law allows for an award of reasonable attorneys' fees and expenses, an arbitrator can award them to the same extent that a court would. If the arbitrator finds either the substance of your claim or the relief sought in the demand is frivolous or brought for an improper purpose (as measured by the applicable laws), then the payment of all arbitration fees will be governed by the applicable arbitration rules. In such a situation, you agree to reimburse LG for all monies previously disbursed by it that are otherwise your obligation to pay under the applicable arbitration rules. Except as otherwise provided for, LG waives any rights it may have to seek attorneys' fees and expenses from you if LG prevails in the arbitration.

Hearings and Location. If your claim is for \$25 000 or less, you may choose to have the arbitration conducted solely (1) on the basis of documents submitted to the arbitrator, (2) through a telephonic hearing, or (3) by an in-person hearing as established by the applicable arbitration rules. If your claim exceeds \$25 000, the right to a hearing will be determined by the applicable arbitration rules. Any in-person arbitration hearings will be held at the nearest, most mutually-convenient arbitration location available within the province or territory in which you reside unless you and LG both agree to another location or agree to a telephonic arbitration.

Severability and Waiver. If any portion of this Limited Warranty (including these arbitration procedures) is unenforceable, the remaining provisions will continue in full force and effect to the maximum extent permitted by applicable law. Should LG fail to enforce strict performance of any provision of this Limited Warranty (including these arbitration procedures), it does not mean that LG intends to waive or has waived any provision or part of this Limited Warranty.

Opt Out. You may opt out of this dispute resolution procedure. If you opt out, neither you nor LG can require the other to participate in an arbitration proceeding. To opt out, you must send notice to LG no later than 30 calendar days from the date of the first consumer purchaser's purchase of the product by either (i) sending an e-mail to optout@lge.com, with the subject line: "Arbitration Opt Out;" or (ii) calling 1-800-980-2973. You must include in the opt out e-mail or provide by telephone: (a) your name and address; (b) the date on which the product was purchased; (c) the product model name or model number; and (d) the serial number (the serial number can be found (i) on the product; or (ii) online by accessing https://www.lg.com/ca_en/support/repair-service/schedule-repair and clicking on "Find My Model & Serial Number").

WARRANTY (CANADA)

In the event that you “Opt Out”, the law of the province or territory of your residence shall govern this Limited Warranty and any disputes between you and LG except to the extent that such law is preempted by or inconsistent with applicable federal or provincial/territorial law. Should arbitration not be permitted for any claim, action, dispute or controversy between you and LG, you and LG agree to attorn to the exclusive jurisdiction of the courts of the province or territory of your residence for the resolution of the claim, action, dispute or controversy between you and LG.

You may only opt out of the dispute resolution procedure in the manner described above (that is, by e-mail or telephone); no other form of notice will be effective to opt out of this dispute resolution procedure. Opting out of this dispute resolution procedure will not affect the coverage of the Limited Warranty in any way, and you will continue to enjoy the full benefits of the Limited Warranty. If you keep this product and do not opt out, then you accept all terms and conditions of the arbitration provision described above.

Conflict of Terms. In the event of a conflict or inconsistency between the terms of this Limited Warranty and the End User License Agreement (“EULA”) in regards to dispute resolution, the terms of this Limited Warranty shall control and govern the rights and obligations of the parties and shall take precedence over the EULA.



US	Please call the installing contractor of your product, as warranty service will be provided by them.
CANADA	Service call Number # : (888) LG Canada, (888) 542-2623 Numéro pour les appels de service : LG Canada, 1-888-542-2623