



MultiSITE CRC1 Series Controllers INSTALLATION MANUAL



PREMTBVC0 – MultiSITE CRC1

PREMTBVC1 – MultiSITE CRC1+

PROPRIETARY DATA NOTICE

This document, as well as all reports, illustrations, data, information, and other materials are the property of LG Electronics U.S.A., Inc., and are disclosed by LG Electronics U.S.A., Inc., only in confidence.

Do not throw away, destroy, or lose this manual.

Please read carefully and store in a safe place for future reference.
Content familiarity required for proper installation and operation.

The instructions included in this manual must be followed to prevent product malfunction, property damage, injury, or death to the user or other people. Incorrect operation due to ignoring any instructions will cause harm or damage. A summary of safety precautions begins on page 4.

For more technical materials such as submittals, engineering databooks, and catalogs, visit www.lghvac.com.

IM_CRC1_Series_Controllers_5_17

For continual product development, LG Electronics U.S.A., Inc., reserves the right to change specifications without notice.

©LG Electronics U.S.A., Inc.

This document, as well as all reports, illustrations, data, information, and other materials are the property of LG Electronics U.S.A., Inc.





TABLE OF CONTENTS

| | |
|--|----|
| Safety Instructions | 4 |
| Introduction | 7 |
| Controller Overview | 8 |
| <i>Home Screen</i> | 8 |
| Controller Installation | 9 |
| <i>Selecting Installation Location</i> | 9 |
| <i>Installing the Controller</i> | 11 |
| Controller Setup | 14 |
| <i>Controller Setup</i> | 14 |
| <i>Setpoint Adjustment</i> | 15 |
| Accessories Installation | 17 |
| <i>ZigBee Pro Wireless Module</i> | 17 |
| <i>Ceiling Motion Sensor</i> | 19 |
| <i>Wall Mounted Motion Sensor</i> | 22 |
| <i>Door/Window Sensor</i> | 25 |
| ZigBee Setup | 29 |
| <i>ZigBee Pro Quick Setup</i> | 29 |
| BACnet MS/TP Setup | 31 |
| <i>BACnet MS/TP Quick Setup</i> | 31 |
| Specifications | 32 |
| <i>PREMTBVC0 and PREMTBVC1</i> | 32 |



SAFETY INSTRUCTIONS

The instructions below must be followed to prevent product malfunction, property damage, injury or death to the user or other people. Incorrect operation due to ignoring any instructions will cause harm or damage. The level of seriousness is classified by the symbols below.

TABLE OF SYMBOLS

| | |
|--|--|
|  DANGER | <i>This symbol indicates an imminently hazardous situation which, if not avoided, will result in death or serious injury.</i> |
|  WARNING | <i>This symbol indicates a potentially hazardous situation which, if not avoided, could result in death or serious injury.</i> |
|  CAUTION | <i>This symbol indicates a potentially hazardous situation which, if not avoided, may result in minor or moderate injury.</i> |
| Note: | <i>This symbol indicates situations that may result in equipment or property damage accidents only.</i> |
|  | <i>This symbol indicates an action that should not be performed.</i> |

DANGER

-  **Risk of electric shock. Disconnect all power before servicing.**
-  **Do not touch any exposed wiring, terminals, or other electrical components with tools or exposed skin. Only qualified technicians should install, use or remove this unit.**

Improper installation or use may result in fire, explosion, electric shock, physical injury and/or death.

-  **Don't use or store flammable gas or combustibles near an outdoor or indoor unit.**

There is risk of fire, explosion, and physical injury or death.

WARNING

The information in this manual is intended for use by a trained technician familiar with the U.S. National Electric Code (NEC) who is equipped with the proper tools and test instruments.

Failure to carefully read and follow all instructions in this manual may result in equipment malfunction, property damage, personal injury and/or death.

SAFETY INSTRUCTIONS

⊘ Do not install the MultiSITE Controller unit if it will be exposed to rain or other precipitation.

⊘ Do not install the unit in a location exposed to open flame or extreme heat.

⊘ Do not touch the unit with wet hands.

There is risk of fire, electric shock, physical injury and/or death.

Replace all control box and panel covers.

If cover panels are not installed securely, dust, water and animals may enter the unit, causing fire, electric shock, and physical injury or death.

Wear protective gloves when handling equipment.

Sharp edges may cause personal injury.

Dispose of any packing materials safely.

- *Packing materials, such as nails and other metal or wooden parts may cause puncture wounds or other injuries.*
- *Tear apart and throw away plastic packaging bags so that children may not play with them and risk suffocation and death.*

⊘ Do not change the settings of the protection devices.

If the pressure switch, thermal switch, or other protection device is shorted and forced to operate improperly, or parts other than those specified by LG are used, there is risk of fire, electric shock, explosion, and physical injury or death.

If the air conditioner is installed in a small space, take measures to prevent the refrigerant concentration from exceeding safety limits in the event of a refrigerant leak.

Consult the latest edition of ASHRAE (American Society of Heating, Refrigerating, and Air Conditioning Engineers) Standard 15. If the refrigerant leaks and safety limits are exceeded, it could result in personal injuries or death from oxygen depletion.

Note:

MultiSITE Controller is for use with select LG commercial air conditioning systems only.

⊘ Do not attempt to use MultiSITE Controller with any other type of system. Refer to the compatible equipment list in this manual.

There is risk of equipment damage or degraded performance

⊘ Do not cut, lengthen or shorten the cable between the MultiSITE Controller unit and the indoor unit.

⊘ Do not install the MultiSITE Controller unit in a location where the cable cannot be safely and easily connected between the two units.

⊘ Do not allow strain on this cable.

There is risk of equipment damage.



SAFETY INSTRUCTIONS

Note:

Clean up the site after all procedures are finished, and check that no metal scraps, screws, or bits of wiring have been left inside or surrounding the controller or indoor units.

Provide power to the outdoor unit compressor crankcase heaters at least six (6) hours before operation begins.

Starting operation with a cold compressor sump(s) may result in severe bearing damage to the compressor(s). Keep the power switch on during the operational season.

⊘ **Do not block the indoor unit inlet or outlet.**

Unit may malfunction.

Securely attach the electrical cover to the indoor unit. Non-secured covers can result in fire due to dust or water in the service panel.

⊘ **Do not allow water, dirt, or animals to enter the unit.**

There is risk of unit failure or degraded performance.

⊘ **Do not spill water or other liquid on the inside of the indoor unit, especially on electrical components.**

⊘ **Do not drop the MultiSITE Controller unit into water. If the unit is immersed in water or other liquid, contact your local authorized LG distributor for support.**

There is risk of unit failure or degraded performance.

Electronic controls are static sensitive devices.

Discharge yourself correctly before manipulating and installing the MultiSITE Controller.

This device must be installed to provide a separation distance of at least 8 inches from all persons and must not be located or operating in conjunction with any other antenna or transmitter.

Operation is subject to the following two conditions: (1) this device may not cause interference, and (2) this device must accept any interference, including interference that may cause undesired operation of the device.

A short circuit or wrong wiring may permanently damage Remote Controller or equipment.

MultiSITE CRC1 Series Controllers

This manual describes how to install the LG MultiSITE Commercial Remote Controllers (CRC) 1 and the accessories described below. There are two controller models:

- MultiSITE CRC1 (Model PREMTBVC0)
- MultiSITE CRC1+ (Model PREMTBVC1)

The two models are identical with the exception of two functions included in the MultiSITE CRC1+ only:

- Motion sensor
- Humidity sensor

Compatible Equipment

MultiSITE CRC1 Controllers are compatible with LG Commercial Air Conditioning indoor units (except PTAC units).

⊘ Do not attempt to use a MultiSITE CRC1 controller with any other equipment.

Accessories

These accessories are available for MultiSITE CRC1 controllers:

- ZigBee® Pro wireless card
Model ZVRCZPWC1
- Door and window switch
Model ZVRCZDWS1
- Wall mounted occupancy sensor
Model ZVRCZWOC1
- Ceiling mounted occupancy sensor
Model ZVRCZCOC1

The ZigBee® Pro wireless card is required for communication between the controller and the other accessories.

Safety

Safety of personnel is the primary concern during all procedures. Read and understand the safety summary at the front of this manual.

Typical MultiSITE
CRC1 Controller



MultiSITE CRC1 Controller
Optional Accessories



ZigBee® Pro Wireless Card



Door/Window Switch



Wall Mounted
Occupancy Sensor



Ceiling Mounted
Occupancy Sensor

CONTROLLER OVERVIEW

Home Screen

The controller home screen is shown and described below.

MultiSITE CRC 1 Controller

Current Date

Occupancy Status

Occupied (Occ) or
Unoccupied (Unocc)

**Room Indoor
Temperature**

**Room Indoor
Humidity**

On/Off

Turn the display
on or off

Operation Mode

Set Cool, Heat, Auto
Cool, Auto Heat, Fan,
Dry modes



Note: Pressing and holding
the Operation Mode icon
takes the user to the
Operation Mode page.

**Short Network
Message**

Note:

Available functions/features may differ based on the connected system.

When any change is made to a parameter, the value is automatically saved in memory when the next parameter is selected or another page is opened.

Arrows auto-increment/decrement at higher speed when holding button for more than 2.5 seconds.

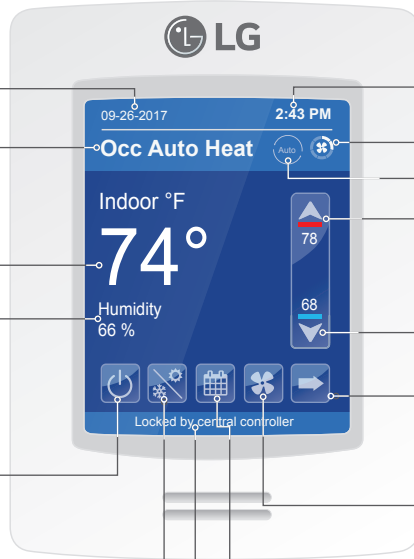

Current Time

**Current Fan
Speed Setting**

**Operation Mode
Status**

Up Arrow

Raise Temperature
Setpoint

Down Arrow

Lower Tempera-
ture Setpoint

More

Provides user with
access to less often
used functions.

Fan Speed

Set fan to Slow,
Low, Low-Med,
Medium, Med-High,
High, Power, Auto.
(Available options
depend on IDU
model.)



Note: Long-press of the
Fan Speed button when in
cooling mode triggers Power
Cooling mode. If in Power
Cooling mode, last airflow
segment on top is lit in purple
and the text changes from
"Fan" to "Power Cool." This
mode lasts for 30 minutes
and then reverts back to the
previous fan speed.

CONTROLLER INSTALLATION

Selecting Installation Location

The room temperature sensor is inside the controller, so the installation location is critical to proper system operation. Install the controller in a location away from direct sunlight, high humidity, and direct flow of hot or cold air. Install the controller on a flat, clean wall surface approximately 5 ft above the floor in an area with good circulation and average temperature.

The PREMTBVC1 controller contains a

⊘ Do not install the controller where it is exposed to:

- Drafts or dead spots behind doors and in corners
- Hot or cold air from ducts
- Radiant heat from sun or appliances
- Concealed pipes or chimneys
- Uncontrolled areas such as on an outside wall

Refer to Figure 1 for a typical installation location.

Figure 1: Typical Controller Location

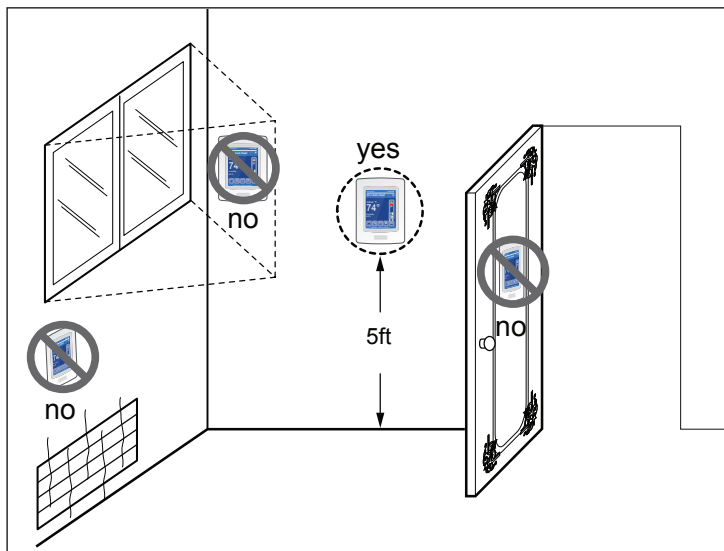

CONTROLLER INSTALLATION

Selecting Installation Location – continued

The PREMTBVC1 contains a passive infrared (PIR) sensor. Refer to Figure 2 for PIR sensor information to consider when selecting the PREMTBVC1 installation location.

Figure 2: Motion (PIR) Sensor Installation

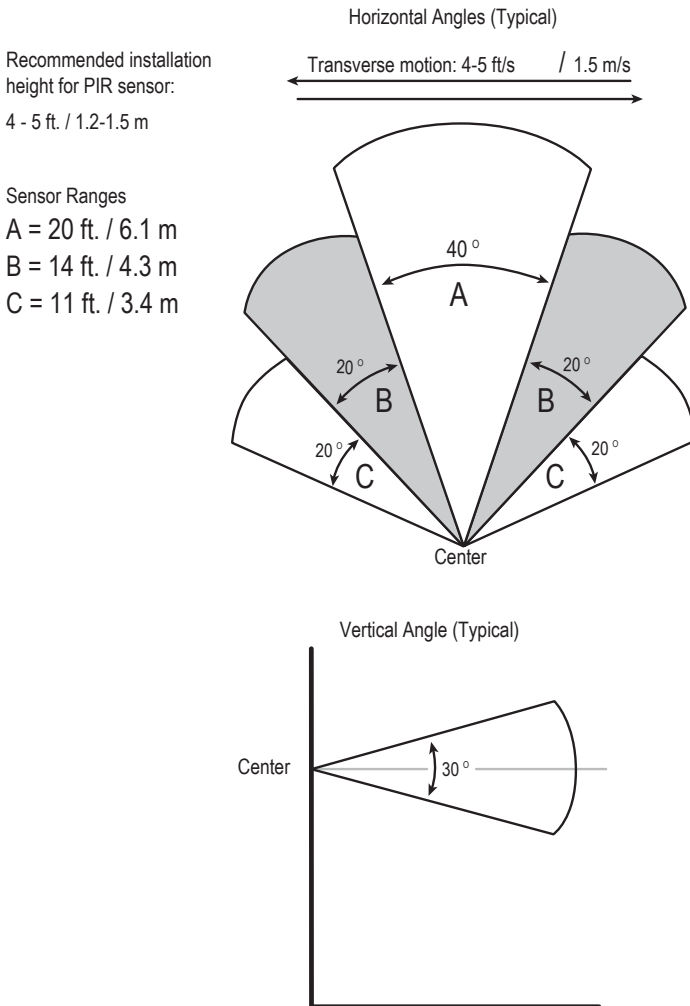

CONTROLLER INSTALLATION

Installing the Controller

Follow this procedure to install the controller.

Note:

- If replacing an existing MultiSITE CRC1 Series Remote Controller, label the wires before removal.
- Electronic controls are static sensitive devices. Discharge yourself properly before manipulating and installing the Remote Controller.
- A short circuit or wrong wiring may permanently damage the Remote Controller or the equipment.
- This Remote Controller must be installed to provide a separation distance of at least 8 inches from all persons and must not be collocated or operating in conjunction with any other antenna or transmitter.
- If your installation includes wireless accessories, you can install the optional ZigBee Pro wireless module when the controller case is open. Refer to page 17 for ZigBee Pro wireless module installation instructions.
- Maximum cable length is 164ft. Do not splice wiring.
- Cable Type: 3 conductor, 22 AWG, unshielded, twisted, and stranded.
- If the indoor unit does not have screw terminals for field wiring, Extension Cable PZCWR1 is required. The green Molex connector of this cable connects to the IDU. The white Molex connector of this cable is removed and the wires connected to the Remote Controller as described below.

1. Remove security screw (if any) on bottom of Remote Controller cover (Figure 3).
2. Read FCC ID and IC label installed in cover before installing any wireless product.
3. Ensure correct side of base faces up.
4. Pull cable 6 inches out from wall.
5. Align base and mark location of two mounting holes on wall (Figure 4).
6. Install anchors in wall.
7. Insert communication cable through center opening of base.

Figure 3: Open Cover

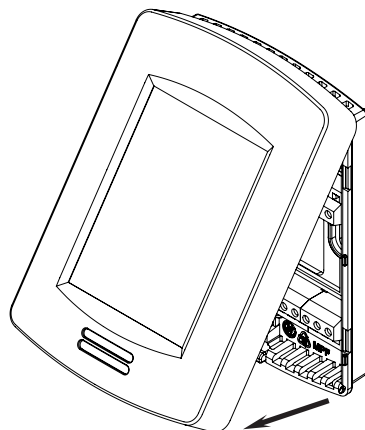

CONTROLLER INSTALLATION

Installing the Controller – continued

8. Insert screws in mounting holes on each side of base.
9. If using field-provided communication cable, strip each wire 1/4 inch from end.
10. If using Extension Cable PZCWRC1, carefully cut off the white Molex connector and strip each wire 1/4 inch from end.

Figure 4: Install Base

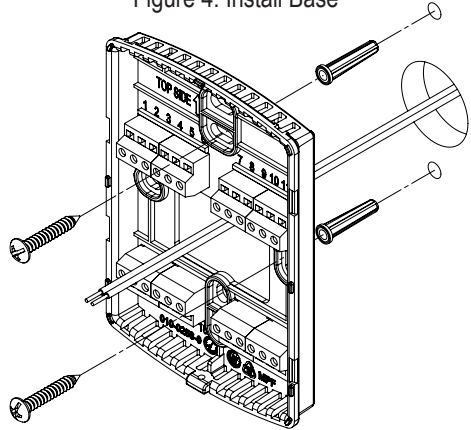
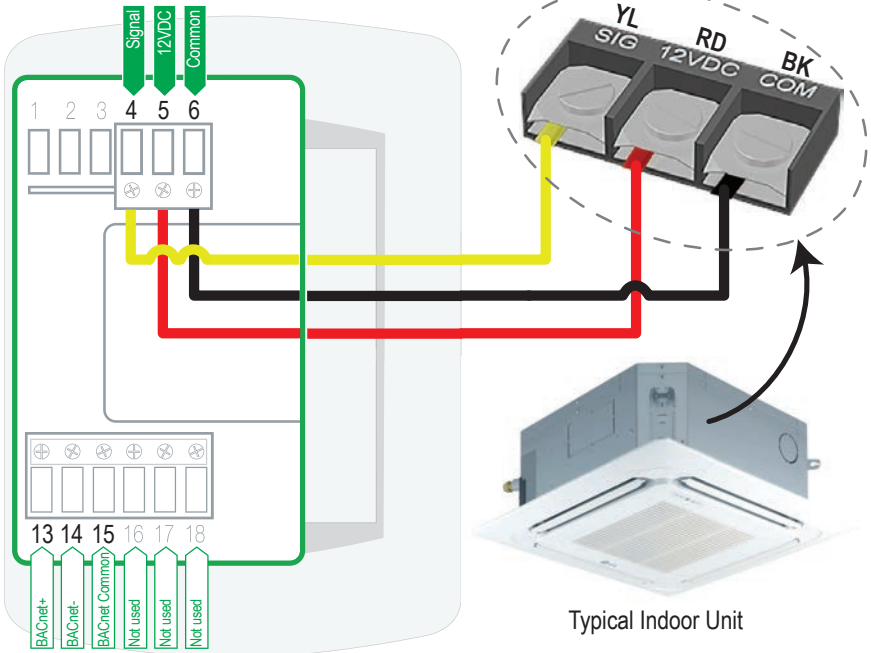

Figure 5: Controller Wiring



CONTROLLER INSTALLATION

Installing the Controller – continued

11. Insert each wire in terminal block according to wiring diagram (Figure 5).
Table 1 lists the function of all terminal connections.
12. Carefully push excess cable back into hole.
13. Gently align cover to top of base and snap in place from bottom (Figure 6).
14. Install security screw.

Figure 6: Reinstall Cover

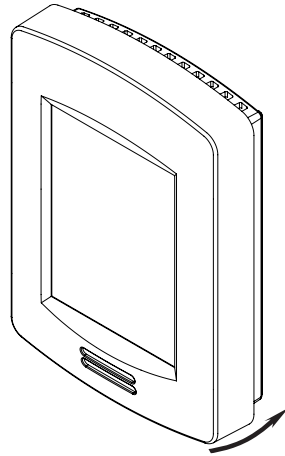

Table 1: Controller Terminal Functions

| Terminal | Function |
|--------------------|----------------------------|
| Terminal 1 | Not used |
| Terminal 2 | Not used |
| Terminal 3 | Not used |
| Terminal 4 | Signal Wire |
| Terminal 5 | 12VDC |
| Terminal 6 | Common |
| Terminal 13 | BACnet + |
| Terminal 14 | BACnet - |
| Terminal 15 | BACnet MS/TP Common |
| Terminal 16 | Not used |
| Terminal 17 | Not used |
| Terminal 18 | Not used |

CONTROLLER SETUP

Controller Setup

This section contains a brief overview of MultiSITE controller operation. Refer to the MultiSITE CRC Series User Manual for more information.

Figure 7: Controller Setup



Touch and hold this point for 3 seconds to enter setup mode

If a configuration / installer password is activated to prevent unauthorized access to the configuration menu parameters, a password entry prompt will appear to prevent access to the device configuration components.

MultiSITE CRC 1 Controller

Setpoint Adjustment

Setpoints can be modified in three different ways when in Auto Mode: Cooling Setpoint change, Heating Setpoint change or Cooling/Heating Setpoint change.

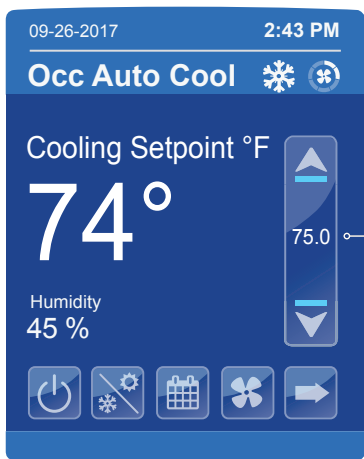

Cooling mode or cooling only sequence of operation

In Cooling mode, the setpoint displayed in the bar is the current occupied cooling setpoint.

During occupied setpoint adjustment, the large digits are temporarily used to display the occupied cooling setpoint while it is adjusted.

Normal temperature display resumes after the setpoint is adjusted and the actual occupied cooling setpoint is displayed in the setpoint bar.

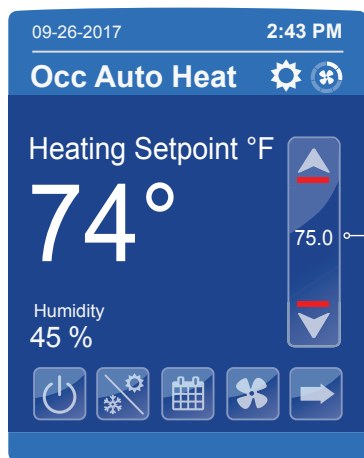

Heating mode or heating only sequence of operation

In Heating mode, the setpoint displayed in the bar is the current occupied heating setpoint.

During occupied setpoint adjustment, the large digits are temporarily used to display the occupied heating setpoint.

Normal temperature display resumes after the setpoint is adjusted and the actual occupied heating setpoint is displayed in the setpoint bar.

CONTROLLER SETUP

Setpoint Adjustment – continued

MultiSITE CRC 1 Controller



Automatic Heating / Cooling mode

In automatic mode, the setpoint displayed at the top of the set point bar located directly under the blue line represent the actual occupied cooling setpoint.

During occupied setpoints adjustment, the large digits are temporarily used to display the occupied "Cooling Setpoint" or occupied "Heating Setpoint." The actual setpoint is dependent on the last effective demand (heating or cooling).

Normal temperature display resumes after the setpoints are adjusted and the actual occupied heating and cooling setpoints are displayed in the setpoint bar.

ACCESSORIES INSTALLATION

ZigBee Pro Wireless Module

Follow this procedure to install the optional ZigBee Pro wireless module (model ZVR-CZPWC1). This wireless module is required for the controller to communicate with the optional wireless sensors.

1. Remove security screw (if any) on bottom of Remote Controller cover.
2. Open unit by pulling on bottom side of Remote Controller (Figure 9).
3. Carefully remove Remote Controller's Motherboard from casing and turn over.
4. Locate gap in upper-right corner of Remote Controller's motherboard and locate holes to insert ZigBee Pro module to motherboard (Figure 10).
5. Align connector pins on ZigBee Pro module with holes on motherboard. Ensure alignment of pins is correct so as to not damage ZigBee Pro module.

Figure 8: ZigBee Pro Wireless Module



Figure 9: Open Cover

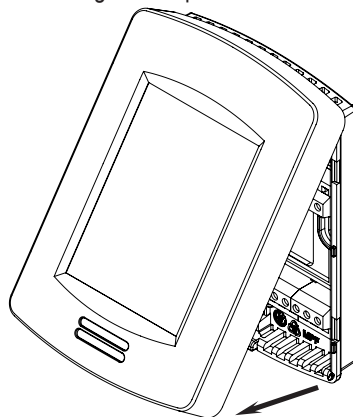

*ZigBee is a registered trademark of the ZigBee Alliance.



Due to our policy of continuous product innovation, some specifications may change without notification.
©LG Electronics U.S.A., Inc., Englewood Cliffs, NJ. All rights reserved. "LG" is a registered trademark of LG Corp.

ACCESSORIES INSTALLATION

6. Gently press the ZigBee Pro module into the Remote Controller's motherboard until it fits snugly in place.

⊘ Do not press too hard to avoid damage to ZigBee Pro module.

7. Carefully replace Remote Controller's motherboard into casing.

8. Carefully align cover to top of base and snap in place from bottom (Figure 11).

9. Install security screw.

Figure 10: Install ZigBee Pro Wireless Module

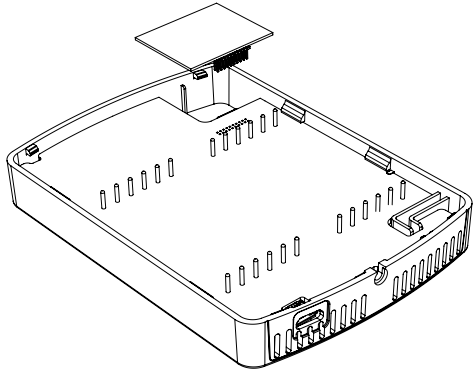
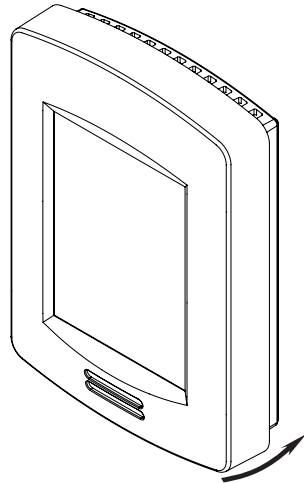

Figure 11: Reinstall Cover



ACCESSORIES INSTALLATION

Ceiling Motion Sensor

Follow this procedure to install the optional wireless ceiling motion sensor.

Figure 12: Ceiling Motion Sensor



Consider the following location constraints before installing a ceiling mounted sensor:

- Do not install on a metal surface.
- Do not install in areas with a direct heat source.
- Do not install near any air discharge grill.
- Do not install in areas exposed to direct sunlight.
- Ensure ceiling surface is flat and clean.
- Install in a dry location away from water, moisture, or rain.

Sensor Placement

Figure 13 shows suggested placement guidelines to optimize detection zones.

Figure 13: Ceiling Sensor Detection Zones

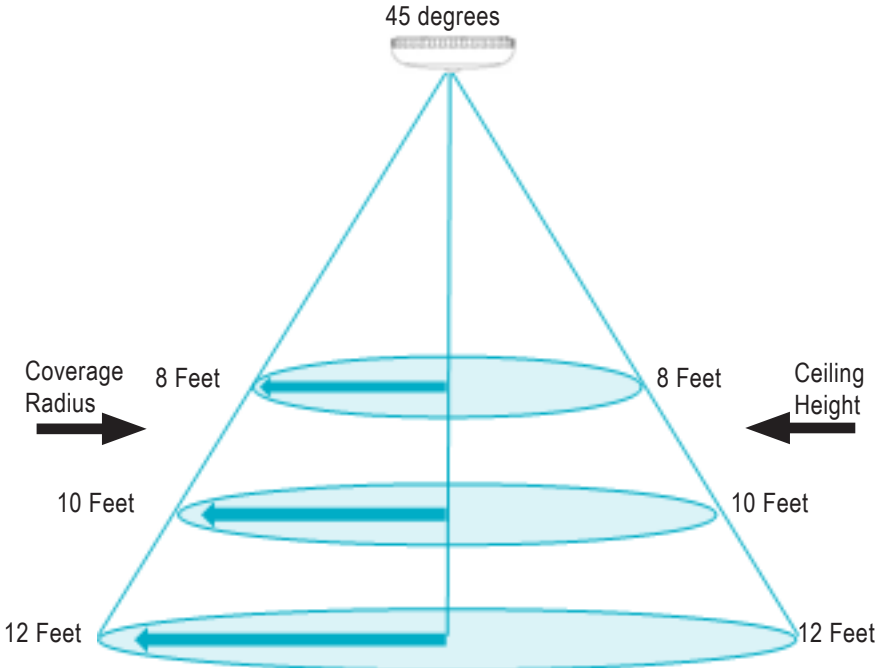

ACCESSORIES INSTALLATION

Installation Sequence

Complete the following steps (in this order) to correctly install the ceiling mounted motion sensor:

- Install batteries.
- Pair sensor with MultiSITE Controller.
- Verify sensing motion.
- Install sensor to ceiling surface.

Install Batteries

1. Remove mounting plate by rotating housing counter-clockwise (Figure 14).
2. Install two AAA batteries in Sensor Housing (Figure 15). Ensure battery polarity is correct. When batteries are first installed, the sensor automatically goes into pairing mode. Refer to “ZigBee Setup” on page 29.
3. Replace mounting plate by rotating housing clockwise.
4. Proceed to Verify Sensing Motion.

Verify Sensing Motion

1. Wait three minutes for sensor to warm up. Sensor requires a three minute warm-up before it reporting any motion detection.
2. Wave hand or object over top area of sensor.
3. Verify LED flashes red on sensor (Figure 16). LED flashing red indicates motion detected.
4. Proceed to Install Ceiling Motion Sensor.

Figure 14: Remove Mounting Plate

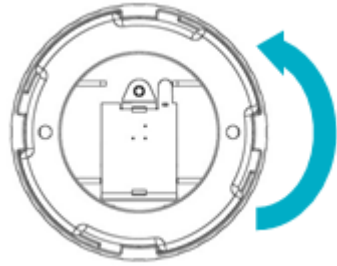

Figure 15: Install Batteries

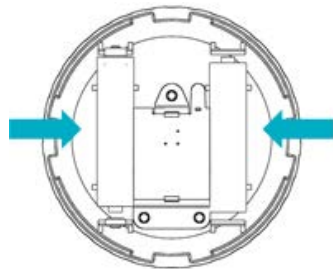
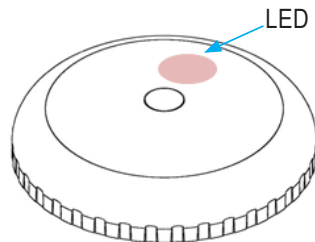

Figure 16: Flashing LED



Install Ceiling Motion Sensor

1. Consider sensor placement conditions before installing sensor. Refer to “Sensor Placement” on page 19.
2. Secure mounting plate to overhead surface with two screws (Figure 17). Ensure screws are tight and mounting plate does not move easily.
⊘ Do not torque screws.
3. Set sensor housing assembly on mounting plate (Figure 17).
4. Rotate sensor housing assembly clockwise until it locks in place. Ensure sensor housing assembly fits snugly to mounting plate.
5. Test the ceiling motion sensor again according to “Verify Sensing Motion” on page 20.

Figure 17: Installing Sensor on Ceiling

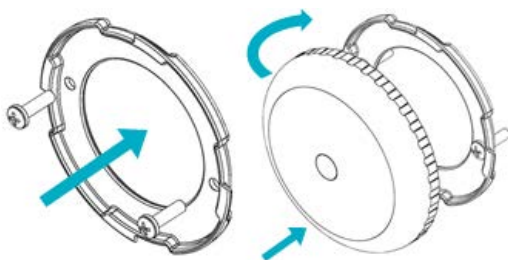

Sensor Functions

Figure 18 shows the location of the function button on the sensor module. Refer to “Table 2: Function Button and LED Indicators” on page 30 for information on using this button and the LED indicator to set up sensor module operation.

Figure 18: Function Button and LED

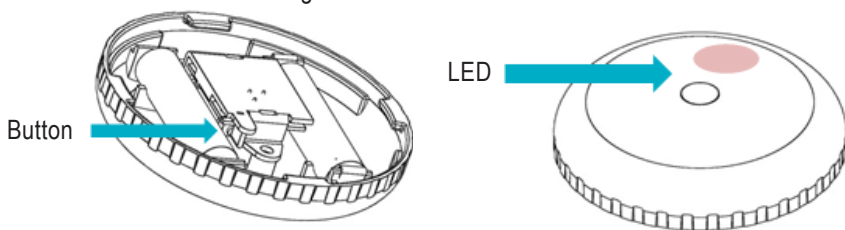

Test Sensor with Controller

Refer to “ZigBee Pro Quick Setup” on page 29 for information on how to test sensor operation.

ACCESSORIES INSTALLATION

Wall Mounted Motion Sensor

Follow this procedure to install the optional wireless wall mounted motion sensor.

Consider the following location constraints before installing a ceiling mounted sensor:

- Do not install on a metal surface.
- Do not install in areas with a direct heat source.
- Do not install near any air discharge grill.
- Do not install in areas exposed to direct sunlight.
- Ensure wall surface is flat and clean.
- Install in a dry location away from water, moisture, or rain.

Sensor Placement

Figure 20 shows suggested placement guidelines to optimize detection zones.

Figure 19: Wall Mounted Motion Sensor



Figure 20: Wall Mounted Motion Sensor Coverage Area

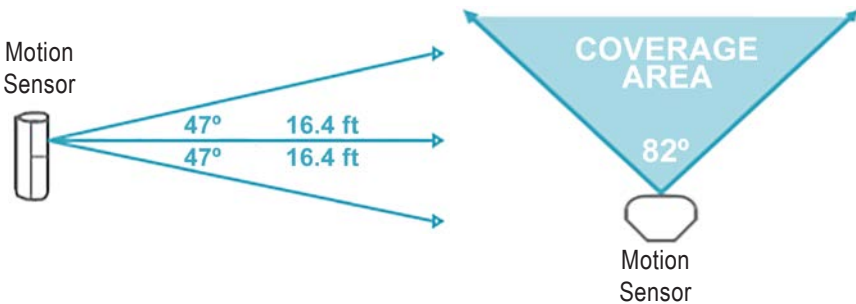

ACCESSORIES INSTALLATION

Installation Sequence

Complete the following steps (in this order) to correctly install the ceiling mounted motion sensor:

- Install battery.
- Pair sensor with MultiSITE Controller.
- Remove plastic pull tab.
- Verify sensing motion.
- Install sensor to ceiling surface.

Install Battery

1. Use a flathead screwdriver to carefully pry cover away from motion sensor (Figure 21).
2. Install one CR2 battery in Sensor Housing (Figure 22). Ensure battery polarity is correct. When battery is first installed, the sensor automatically goes into pairing mode. Refer to “ZigBee Setup” on page 29.
3. Replace cover on motion sensor.
4. Proceed to Verify Sensing Motion.

Verify Sensing Motion

1. Wait three minutes for sensor to warm up. Sensor requires a three minute warm-up before it reporting any motion detection.
2. Wave hand or object in front of sensor.
3. Verify LED flashes red on sensor (Figure 16). LED flashing red indicates motion detected.
4. Proceed to Install Wall Mounted Motion Sensor.

Figure 21: Remove Sensor Cover



Figure 22: Install Battery

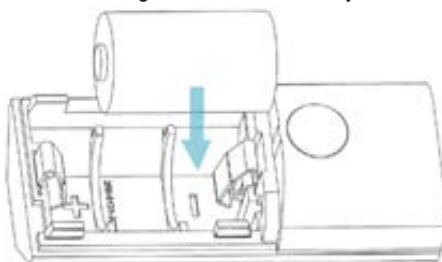
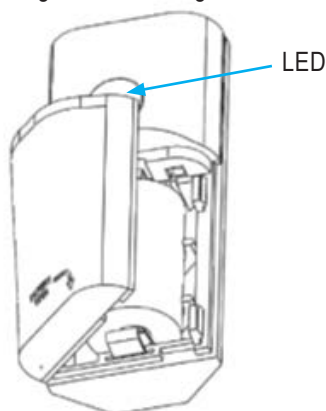

Figure 23: Flashing LED



ACCESSORIES INSTALLATION

Install Wall Mounted Motion Sensor

Install the motion sensor to the desired location. The motion sensor can be installed vertically, horizontally, or upside down on a flat surface or in a corner.

1. Consider sensor placement conditions before installing sensor. Refer to “Sensor Placement” on page 22.
2. Affix two-sided tape to desired installation location (Figure 24).
3. Position motion sensor on two-sided tape and press firmly to secure in place.
4. Test the wall mounted motion sensor again according to “Verify Sensing Motion” on page 23

Figure 24: Wall Mounted Motion Sensor Installation

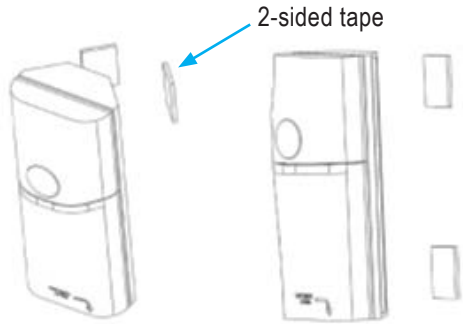

Sensor Functions

Figure 25 shows the location of the function button on the sensor module. Refer to “Table 2: Function Button and LED Indicators” on page 30 for information on using this button and the LED indicator to set up sensor module operation.

Figure 25: Function Button and LED

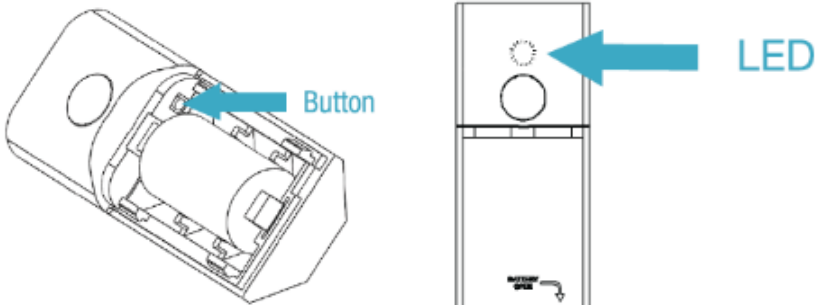

Test Sensor with Controller

Refer to “ZigBee Pro Quick Setup” on page 29 for information on how to test sensor operation.

ACCESSORIES INSTALLATION

Door/Window Sensor

Follow this procedure to install the optional door/window sensor.

Consider the following location constraints before installing a door/window sensor:

- Do not install on a metal surface.
- Do not install in areas with a direct heat source.
- Do not install near any air discharge grill.
- Do not install in areas exposed to direct sunlight.
- Ensure mounting surface is flat and clean.
- Install in a dry location away from water, moisture, or rain.

Figure 26: Door/Window Sensor



Sensor Placement

Figure 27 shows suggested placement guidelines to optimize sensor operation. Ensure contact switch and magnet face each other as shown in Figure 27. The contact switch and magnet can be a maximum of 0.75 in apart. If aligned properly, you will hear a 'click' when they approach.

Figure 27: Door/Window Sensor Placement

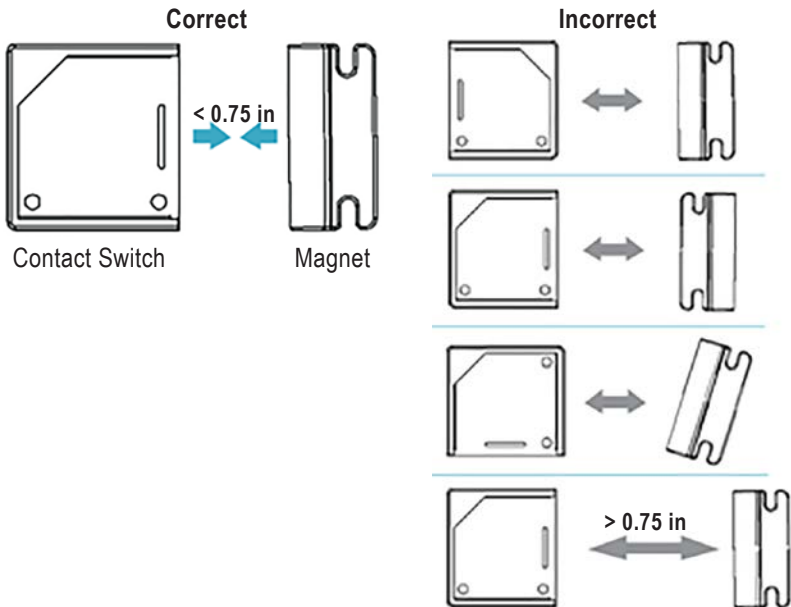

ACCESSORIES INSTALLATION

Installation Sequence

Complete the following steps (in this order) to correctly install the door/window sensor:

- Install batteries.
- Pair sensor with MultiSITE Controller.
- Remove plastic pull tab.
- Install sensor housing.
- Install magnet.
- Install sensor.

Install Battery

1. Pull tab and slide open housing of door/window sensor to access battery (Figure 28).
2. Install one CR2032 battery in the housing (Figure 29). Ensure battery polarity is correct. When battery is first installed, the sensor automatically goes into pairing mode. Refer to “ZigBee Setup” on page 29.
3. If replacing an old battery, use a plastic tool to carefully pry battery out of compartment.
⊘ Do not use a metal tool; it may cause a short circuit or cause damage to the sensor.
4. Replace housing cover.

Figure 28: Open Housing

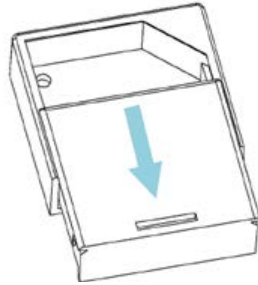
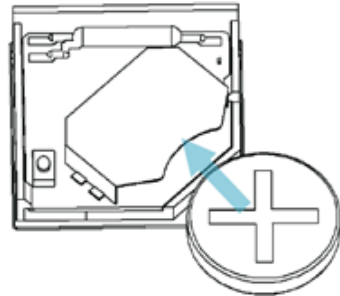

Figure 29: Install Battery



Install Sensor Housing

Use either screws or two sided tape to install the sensor housing. The sensor housing and the magnet must align properly. The sensor and magnet must be within 0.75 inches of each other. Be sure to install the parts in the correct orientation.

To install with tape:

1. Affix 2-sided tape to desired location (Figure 30). Ensure tape is flush with

ACCESSORIES INSTALLATION

surface and securely affixed to surface.

2. Position sensor housing on two sided tape and press firmly to secure in place.
3. Ensure the sensor is paired. If necessary, refer to “ZigBee Pro Quick Setup” on page 29.
4. Slide the sensor into the housing.

To install with screws:

1. Secure the sensor housing to the desired location with two screws (Figure 31). Ensure screws are tight and sensor does not move easily.
⊘ Do not torque screws.
2. Ensure the sensor is paired. If necessary, refer to “ZigBee Pro Quick Setup” on page 29.
3. Slide the sensor into the housing.

Install Magnet

Use either screws or two sided tape to install the magnet. The sensor housing and the magnet must align properly. The sensor and magnet must be within 0.75 inches of each other. Be sure to install the parts in the correct orientation.

If installing with tape, the magnet’s screw tab can be removed by snapping the tab along the scored line (Figure 32). To install with tape:

1. Refer to Figure 27 for relative positioning of sensor and magnet.
2. Affix 2-sided tape to desired location. Ensure tape is flush with surface and securely affixed to surface.
3. Position the magnet on the two sided tape and press firmly to secure in place.

To install with screws:

1. Refer to Figure 27 for relative positioning of sensor and magnet.
2. Secure the magnet to the desired location with two screws. Ensure screws are tight and magnet does not move easily.
⊘ Do not torque screws.

Figure 30: Install Sensor with Tape

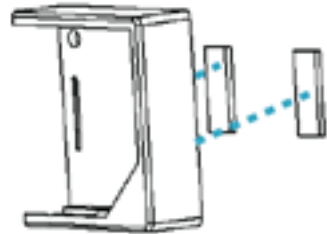
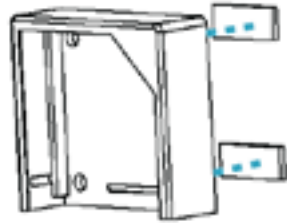
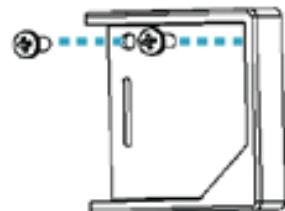
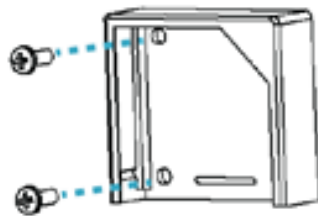

Figure 31: Install Sensor with Screws



ACCESSORIES INSTALLATION

Sensor Functions

Figure 33 shows the location of the function button on the sensor module. Refer to “Table 2: Function Button and LED Indicators” on page 30 for information on using this button and the LED indicator to set up sensor module operation.

Figure 32: Remove Screw Tab if Desired

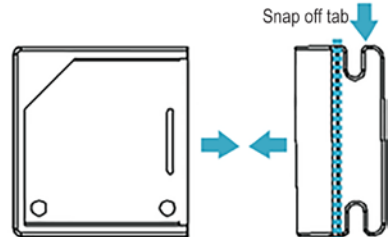
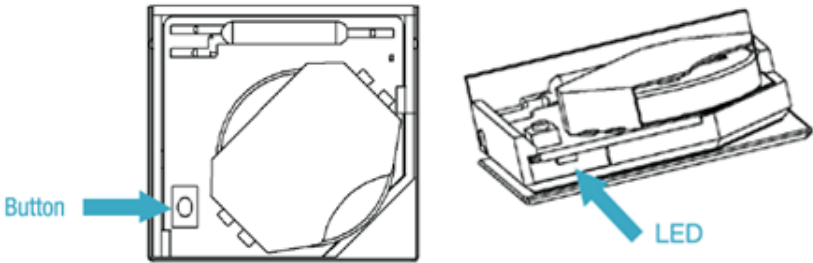

Figure 33: Function Button and LED



Test Sensor with Controller

Refer to “ZigBee Pro Quick Setup” on page 29 for information on how to test sensor operation.

ZigBee Pro Quick Setup

This quick set-up describes how to pair a ZigBee sensor with a Remote Controller. Please see ZigBee Configuration section of the MultiSITE CRC1 User Interface Guide if this is the first time a sensor is being paired with the remote controller for proper configuration of the ZigBee Wireless network.

















1. Go to first Zone screen in Wireless Ecosystem section of MultiSITE CRC1 Series Remote Controller's interface and set "Permit join" to On. Permit join is only available on the first Zone Screen but is applicable to all Zones.
2. Insert battery or remove pull tab (for contact sensors) to activate ZigBee sensor. If sensor does not join ZigBee wireless network press the button located on the sensor ten (10) times to reinitialize joining process.
3. Verify sensor has joined network and Paired field status reads Yes on Zone screen.
4. Use the "Set function to" control in the Zone Screen to select sensor type (Motion, Window or Door).
5. Set Permit Join on MultiSITE CRC1 Series Remote Controller to Off when pairing process is complete.

Troubleshooting

MultiSITE CRC1 Series Remote Controller User Interface Guide is available at www.lghvac.com.

ZIGBEE SETUP

Table 2: Function Button and LED Indicators

| BUTTON | LED | ACTION | LED | DESCRIPTION |
|------------------------------------|--|--------------------------------------|--|--|
| 2 times |  GG | Network Status |  GGG Joined |  RRR Not Joined |
| | | |  YYY Re-Join in Process | |
| | | | | |
| 4 Times |  GGGG | Network Join |  YRY Searching for Network |  YGY Device Being Configured |
| | | |  GGG Device Joined |  RRR Device Failed to Join |
| | | | | |
| | | | | |
| 8 Times |  GGGGGGGG | Forced Re-Join |  YYY Re-Join, Searching for Parent | |
| 10 Times |  GGGGGGGGGG | Network leave and join a new Network |  RRR Leave if Joined |  GGGGG Defaults Restored |
| | | | | |
| G = Green Y = Yellow R = Red | | No Action |  Y Wrong Button Press | |
| | | |  YGR Device Busy | |
| | | Power Up |  RRYYYG | |

BACnet MS/TP Quick Setup

This quick set-up describes how to set-up the BACnet* MS/TP with a Remote Controller. Please see BACnet MS/TP Configuration section of the MultiSITE CRC1 User Interface Guide for complete instructions of the configuration of the BACnet MS/TP network.

1. Touch and hold top of the screen for 3 seconds to enter Configuration settings as illustrated in Figure 7 on page 14.
2. Navigate to the “BMS Config” --> “BACnet settings” menu of the “Configuration” page.
3. Change the “COM Address.” Valid COM address range is 0-253. Note: COM address defaults to 254 which disables BACnet MS/TP.
4. Select “Network Units” (Imperial or Metric)
5. Select appropriate BAUD Rate. Note: “Auto” is the default setting and will auto detect baud rate of connected device.
6. Select BACnet Instance Number or use default BACnet Instance. Note: BACnet Instance number defaults to 8300 and the COM address. Example if the COM address is 57 the BACnet Instance number will be “83057.”
7. Ensure BACnet status reads Online.

**BACnet is a registered trademark of ASHRAE.*



Due to our policy of continuous product innovation, some specifications may change without notification.
©LG Electronics U.S.A., Inc., Englewood Cliffs, NJ. All rights reserved. “LG” is a registered trademark of LG Corp.

SPECIFICATIONS

PREMTBVC0 and PREMTBVC1

Dimensions

- Height: 4.72 in
- Width: 3.39 in
- Depth: 1.06 in

Power Requirements

- 12 VDC, 2.34W, supplied by IDU

Operating Conditions

- 32 °F - 122 °F
- 0% - 95% R.H. non-condensing

Storage Conditions

- -22 °F - 122 °F
- 0% - 95% R.H. non-condensing

Temperature Sensor

- Local 10 K NTC type 2 thermistor

Temperature Sensor Resolution

- ± 0.2 °F

Temperature Control Accuracy

- ± 0.9 °F @ 70 °F, typical calibrated

Humidity Sensor and Calibration

- Single point calibrated bulk polymer type sensor

Humidity Sensor Precision

- Reading range from 10-90 % R.H. non-condensing,
10 to 20% precision: 10%
20% to 80% precision: 5%
80% to 90% precision: 10%

Humidity Sensor Stability

- Less than 1.0 % yearly (typical drift)

Dehumidification Setpoint Range

- 30% - 95% R.H.

Occ, Stand-By and Unocc Cooling Dual Setpoint Range

- 52 - 99 °F

Occ, Stand-By and Unocc Heating Setpoint Range

- 40 °F - 90 °F

Room Temperature Display Range

- 33 °F - 103 °F

Deadband (2 set point) for Room Temperature control

- Cooling & Heating: Default: 5°F

Wire Gauge

- 22 gauge or larger

Approximate Shipping Weight

- 0.75 lb

Safety Standards All Models

- LVD Directive 2006/95/EC
- EN 60950-1:2006/A2:2013
- UL 873 CSA C22.2 No.24-93

EMC Standards All Models

- EMC Directive 2004/108/EC
- IEC 61326-1:2005
- FCC 15 Subpart B
- ICES-003

Radio Standards (Wireless Models)

- R&TTE Directive 1999/5/EC
- IEC 61326-1:2005
- EN 301 489-1 V1.9.2
- EN 301 328 V1.8.1
- FCC 15 Subpart C
- RSS 210

THIS DEVICE COMPLIES WITH PART 15 OF THE FCC RULES. OPERATION IS SUBJECT TO THE FOLLOWING TWO CONDITIONS: (1) THIS DEVICE MAY NOT CAUSE HARMFUL INTERFERENCE, AND (2) THIS DEVICE MUST ACCEPT ANY INTERFERENCE RECEIVED, INCLUDING INTERFERENCE THAT MAY CAUSE UNDESIRE OPERATION.



Check with your local government for instruction on disposal of these products.

FCC Notice

This equipment has been tested and found to comply with the limits for a Class A digital device, pursuant to part 15 of the FCC Rules. These limits are designed to provide reasonable protection against harmful interference when the equipment is operated in a commercial environment. This equipment generates, uses, and can radiate radio frequency energy and, if not installed and used in accordance with the instruction manual, may cause harmful interference to radio communications. Operation of this equipment in a residential area is likely to cause harmful interference in which case the user will be required to correct the interference at his own expense.

This device complies with part 15 of the FCC Rules. Operation is subject to the following two conditions:

1. This device may not cause harmful interference and
2. This device must accept any interference received, including interference that may cause undesired operation of the device. Any changes or modifications in construction of this device which are not expressly approved by the party responsible for compliance could void the user's authority to operate the equipment.

Industry Canada Statement

Innovation, Science and Economic Development Canada ICES-003

Compliance Label:

CAN ICES-3 (A) / NBM-3 (A)

Innovation, science et développement économique Canada

ICES-003 Label de conformité :

CAN ICES-3 (A) / NBM-3 (A)

LG Customer Information Center, Commercial Products

1-888-865-3026 USA

Follow the prompts for commercial A/C products and parts.



LG Electronics
Commercial Air Conditioning Division

4300 Northpoint Parkway

Alpharetta, Georgia 30022

www.lghvac.com

IM_CRC1_Series_Controllers_5_17
Supersedes: IM_CRC1_Series_Controllers_4_17
Supersedes: IM_CRC1_Series_Controllers_10_16