

INSTALLATION MANUAL

AIR CONDITIONER

Please read this installation manual completely before installing the product. Installation work must be performed in accordance with the national wiring standards by authorized personnel only. Please retain this installation manual for future reference after reading it thoroughly.

Ceiling Concealed Duct



MFL67206507
Rev.05_052219

www.lghvac.com
www.lg.com

Copyright © 2013 - 2019 LG Electronics Inc. All Rights Reserved.

TIPS FOR SAVING ENERGY

Here are some tips that will help you minimize the power consumption when you use the air conditioner. You can use your air conditioner more efficiently by referring to the instructions below:

- Do not cool excessively indoors. This may be harmful for your health and may consume more electricity.
- Block sunlight with blinds or curtains while you are operating the air conditioner.
- Keep doors or windows closed tightly while you are operating the air conditioner.
- Adjust the direction of the air flow vertically or horizontally to circulate indoor air.
- Speed up the fan to cool or warm indoor air quickly, in a short period of time.
- Open windows regularly for ventilation as the indoor air quality may deteriorate if the air conditioner is used for many hours.
- Clean the air filter once every 2 weeks. Dust and impurities collected in the air filter may block the air flow or weaken the cooling / dehumidifying functions.

For your records

Staple your receipt to this page in case you need it to prove the date of purchase or for warranty purposes. Write the model number and the serial number here:

Model number : _____

Serial number : _____

You can find them on a label on the side of each unit.

Dealer's name : _____

Date of purchase : _____

IMPORTANT SAFETY INSTRUCTIONS

READ ALL INSTRUCTIONS BEFORE USING THE APPLIANCE.

Always comply with the following precautions to avoid dangerous situations and ensure peak performance of your product

⚠ WARNING

It can result in serious injury or death when the directions are ignored

⚠ CAUTION

It can result in minor injury or product damage when the directions are ignored

⚠ WARNING

- Installation or repairs made by unqualified persons can result in hazards to you and others.
- Installation of all field wiring and components **MUST** conform with local building codes or, in the absence of local codes, with the National Electrical Code 70 and the National Building Construction and Safety Code or Canadian Electrical code and National Building Code of Canada.
- The information contained in the manual is intended for use by a qualified service technician familiar with safety procedures and equipped with the proper tools and test instruments.
- Failure to carefully read and follow all instructions in this manual can result in equipment malfunction, property damage, personal injury and/or death.

Installation

- Always perform grounding. - Otherwise, it may cause electrical shock.
- For installation of the product, always contact the service center or a professional installation agency. - Otherwise, it may cause a fire, electrical shock, explosion or injury.
- Securely attach the electrical part cover to the indoor unit and the service panel to the outdoor unit. - If the electrical part cover of the indoor unit and the service panel of the outdoor unit are not attached securely, it could result in a fire or electric shock due to dust, water, etc.
- Always install an air leakage breaker and a dedicated switching board. - No installation may cause a fire and electrical shock.
- Do not keep or use flammable gases or combustibles near the air conditioner. - Otherwise, it may cause a fire or the failure of product.
- Ensure that an installation frame of the outdoor unit is not damaged due to use for a long time. - It may cause injury or an accident.
- Do not disassemble or repair the product randomly. - It will cause a fire or electrical shock.
- Do not install the product at a place that there is concern of falling down. - Otherwise, it may result in personal injury.
- Use caution when unpacking and installing. - Sharp edges may cause injury.
- Use a vacuum pump or Inert (nitrogen) gas when doing leakage test or air purge. Do not compress air or Oxygen and Do not use Flammable gases. Otherwise, it may cause fire or explosion. There is the risk of death, injury, fire or explosion.
- Consult your local dealer regarding what to do in case of refrigerant leakage. When the air conditioner is to be installed in a small room, it is necessary to take proper measures so that the amount of any leaked refrigerant does not exceed the concentration limit in the event of a leakage. Otherwise, this may lead to an accident due to oxygen depletion.
- Carry out the specified installation work after taking into account earthquakes. Failure to do so during installation work may result in the unit falling and causing accidents.

4 IMPORTANT SAFETY INSTRUCTIONS

- Make sure that a separate power supply circuit is provided for this unit and that all electrical work is carried out by qualified personnel according to local laws and regulations and this installation manual. An insufficient power supply capacity or improper electrical construction may lead to electric shocks or fire.
- Be sure to switch off the unit before touching any electrical parts.
- Make sure that all wiring is secured, the specified wires are used, and that there is no strain on the terminal connections or wires.
- If refrigerant gas leaks during installation, ventilate the area immediately. Toxic gas may be produced if the refrigerant gas comes into contact with fire.
- Make sure to be materials in a compartment handling air for circulation through a duct supplying only one room.

Operation

- Unplug the unit if strange sounds, smell, or smoke comes from it. - Otherwise, it may cause electrical shock or a fire.
- Keep the flames away. - Otherwise, it may cause a fire.
- Take the power plug out if necessary, holding the head of the plug and do not touch it with wet hands. - Otherwise, it may cause a fire or electrical shock.
- Do not open the suction inlet of the indoor/outdoor unit during operation. - Otherwise, it may cause electrical shock and failure.
- Do not allow water to run into electrical parts. - Otherwise, it may cause the failure of machine or electrical shock.
- Never touch the metal parts of the unit when removing the filter. - They are sharp and may cause injury.
- Do not step on the indoor/outdoor unit and do not put anything on it. - It may cause an injury through dropping of the unit or falling down.
- When the product is submerged into water, always contact the service center. - Otherwise, it may cause a fire or electrical shock.
- Take care so that children may not step on the outdoor unit. - Otherwise, children may be seriously injured due to falling down.

CAUTION

Installation

- Install the drain hose to ensure that drain can be securely done. - Otherwise, it may cause water leakage.
- Install the product so that the noise or hot wind from the outdoor unit may not cause any damage to the neighbors. - Otherwise, it may cause dispute with the neighbors.
- Always inspect gas leakage after the installation and repair of product. - Otherwise, it may cause the failure of product.
- Keep level parallel in installing the product. - Otherwise, it may cause vibration or water leakage.

Operation

- Avoid excessive cooling and perform ventilation sometimes. - Otherwise, it may do harm to your health.
- Use a soft cloth to clean. Do not use wax, thinner, or a strong detergent. - The appearance of the air conditioner may deteriorate, change color, or develop surface flaws.
- Do not use an appliance for special purposes such as preserving animals vegetables, precision machine, or art articles. - Otherwise, it may damage your properties.
- Do not place obstacles around the flow inlet or outlet. - Otherwise, it may cause the failure of appliance or an accident.

TABLE OF CONTENTS

2 TIPS FOR SAVING ENERGY

3 IMPORTANT SAFETY INSTRUCTIONS

6 INSTALLATION PARTS

7 INSTALLATION

8 Ceiling dimension and hanging bolt location

9 Indoor Unit Installation

11 Air Filter

12 Checking the Drainage

13 Indoor Unit Drain Piping

14 Combination indoor units

15 Flaring work

16 Connection of piping - Indoor, Outdoor, BD Unit

17 Plumbing materials and storage methods

19 Indoor Unit Drain Piping

19 Drain test

20 Heat insulation

20 Wiring Connection

20 Connection method of the connecting cable(Example)

24 REMOTE CONTROLLER INSTALLATION

26 Wired remote controller installation

27 HOW TO SET E.S.P?





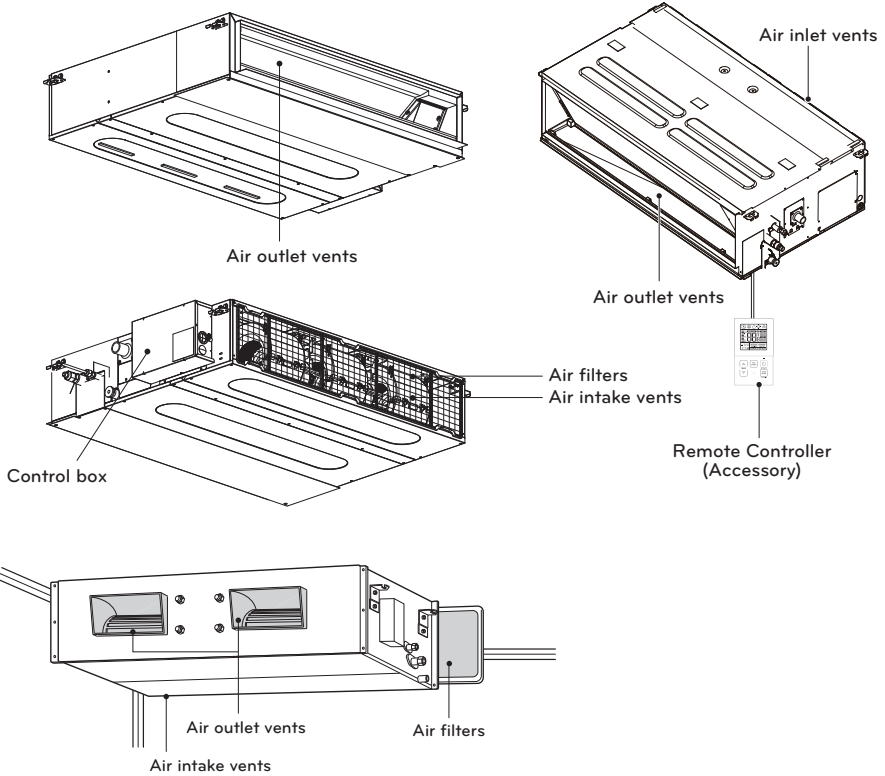

27 Installer Setting - E.S.P.

29 SELF-DIAGNOSIS FUNCTION

29 DIP SWITCH SETTING

INSTALLATION PARTS



Name	Drain hose	Clamp metal	Washer for hanging bracket	Clamp (Tie Wrap)	Insulation for fitting
Quantity	1 EA	2 EA	8 EA	4 EA	1 set
Shape					 for gas pipe  for liquid pipe

* Screws for fixing panels are attached to decoration panel.

INSTALLATION

Indoor unit

Install the air conditioner in the location that satisfies the following conditions.

- The place shall easily bear a load exceeding four times the indoor unit's weight.
- The place shall be able to inspect the unit as the figure.
- The place where the unit shall be leveled.
- The place shall easily connect with the outdoor unit.
- The place where the unit is not affected by an electrical noise.
- The place where air circulation in the room will be good .
- There should not be any heat source or steam near the unit

Confirm the positional relationship between the unit and suspension bolts.

- Installation the ceiling opening to clean the filter or service under the product.

! WARNING

Make sure to be materials in a compartment handling air for circulation through a duct supplying only one room.

[Unit:mm(inch)]

Capacity (kBtu/h)	A	B
9	800 (31-1/2)	800 (31-1/2)
12/18	800 (31-1/2)	1 000 (39-3/8)

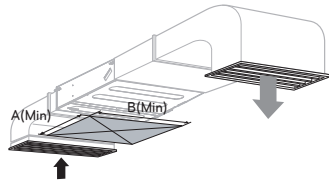

Top view [Unit: mm(inch)]

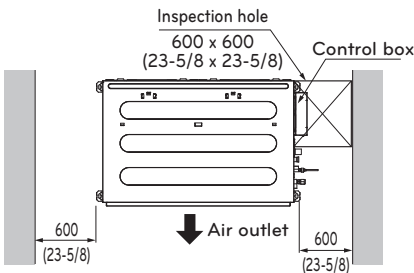

Side view [Unit: mm(inch)]

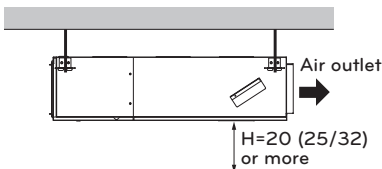

- Suitable dimension "H" is necessary to get a slope to drain as shown in the figure

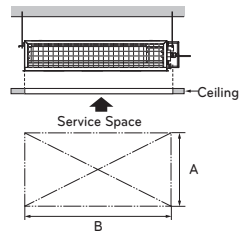

Top view (unit: mm(inch))

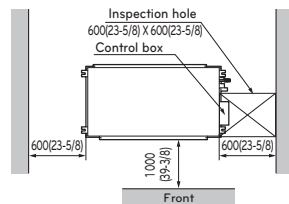

Front view

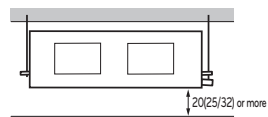

Ceiling dimension and hanging bolt location

Installation of Unit

Install the unit above the ceiling correctly.

POSITION OF SUSPENSION BOLT

- Apply a joint-canvas between the unit and duct to absorb unnecessary vibration.
- Apply a filter Accessory at air return hole.

<TYPE A/D>

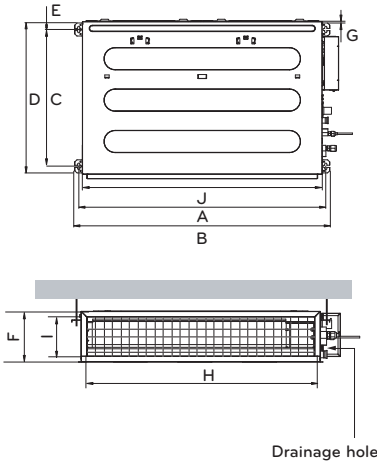

<TYPE B/C>

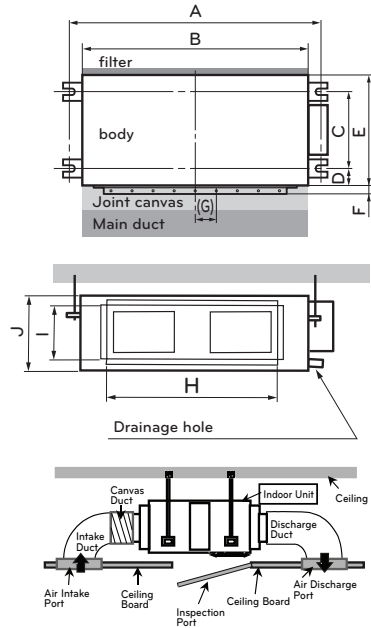

[Unit:mm(inch)]

Capacity (kBTU/h) Dimension	9 k	12 k / 18 k	24 k / 36 k	24 k	36 k	24 k	36 k
Model	AMNW**GL*A* (TYPE A)		AMNW**GBGA0 (TYPE B)	ABNH**GGLA2 (TYPE C)		AMNW**GM*A0 (TYPE D)	
A	733 (28-17/20)	933 (36-37/50)	1 232 (48-1/2)	1 232 (48.5)	1 290(50.8)	933.4 (36-3/4)	1 283.4 (50-17/32)
B	772 (30-2/5)	972 (38-13/50)	1 182 (46-17/32)	1 182 (46.5)	1 230(48.4)	971.6 (38-1/4)	1 321.6 (52-1/32)
C	628 (24-18/25)	628 (24-18/25)	355 (13-31/32)	355 (14)	477(18.8)	619.2 (24-3/8)	619.2 (24-3/8)
D	700 (27-11/20)	700 (27-11/20)	45.5 (1-25/32)	45.5 (1.8)	56(2.2)	700 (27-9/16)	700 (27-9/16)
E	36 (1-2/5)	36 (1-2/5)	450 (17-23/32)	450 (17.7)	590(23.2)	30 (1-3/16)	30 (1-3/16)
F	190 (7-12/25)	190 (7-12/25)	30 (1-3/16)	30 (1.2)	30(1.2)	270 (10-5/8)	270 (10-5/8)
G	20 (25/32)	20 (25/32)	87 (3-7/16)	87 (3.4)	120(4.7)	15.2 (19/32)	15.2 (19/32)
H	660 (25-49/50)	860 (33-17/20)	830 (32-11/16)	830 (32.7)	1 006(39.6)	858 (33-25/32)	1 208 (47-9/16)
I	155 (6-1/10)	155 (6-1/10)	186 (7-5/16)	186 (7.3)	294(11.6)	201.4 (7-15/16)	201.4 (7-15/16)
J	700 (27-11/20)	900 (35-11/25)	298 (11-23/32)	298 (11.7)	380(15)	900 (35-7/16)	1 250 (49-7/32)

* Install the unit leaning to a drainage hole side as a figure for easy water drainage.

POSITION OF CONSOLE BOLT

- A place where the unit will be leveled and that can support the weight of the unit.
- A place where the unit can withstand its vibration.
- A place where service can be easily performed.

<TYPE A/D>

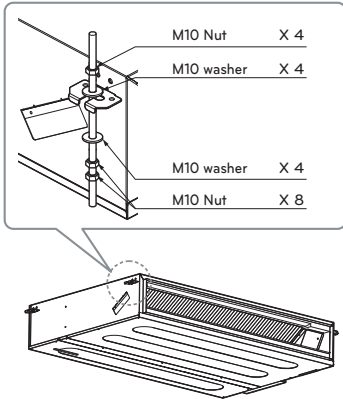

<TYPE B/C>

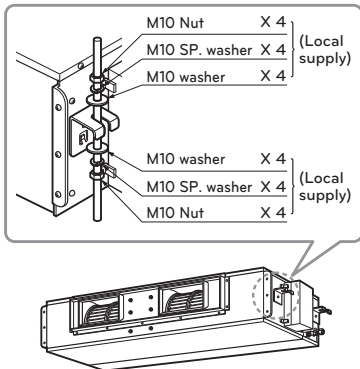

Indoor Unit Installation

- Select and mark the position for fixing bolts.
- Drill the hole for set anchor on the face of ceiling.

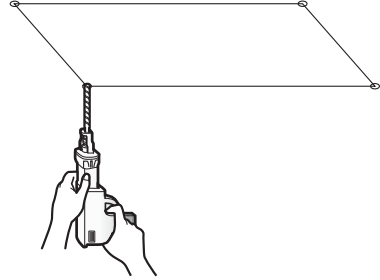

- Insert the set anchor and washer onto the suspension bolts for locking the suspension bolts on the ceiling.
- Mount the suspension bolts to the set anchor firmly.
- Secure the installation plates onto the suspension bolts (adjust level roughly) using nuts, washers and spring washers.

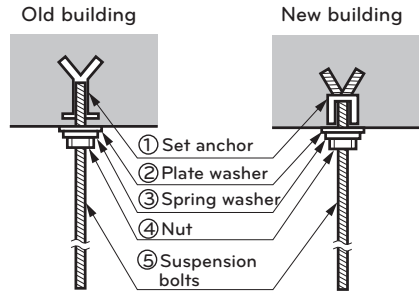

- Local supply
 - ① Set anchor
 - ② Plate washer - M10
 - ③ Spring washer - M10
 - ④ Nut - W3/8 or M10
 - ⑤ Suspension bolt - W3/8 or M10

⚠ CAUTION

Tighten the nut and bolt to prevent unit falling.

CAUTION

- 1 Install declination of the indoor unit is very important for the drain of the duct type air conditioner.
- 2 Minimum thickness of the insulation for the connecting pipe shall be 5 mm(3/16 inch).

Front of view

- The unit must be declined to the drain hose connected when finished installation.

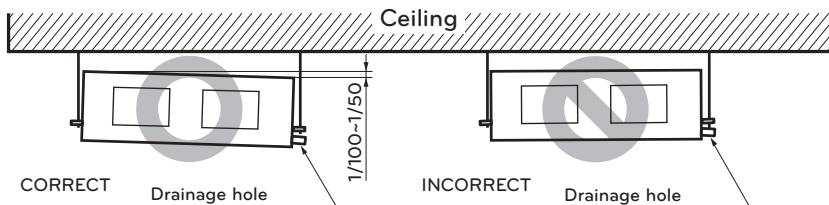

CAUTION FOR GRADIENT OF UNIT AND DRAIN PIPING

Lay the drain hose with a downward inclination so water will drain out.

- Always lay the drain with downward inclination (1/100 to 1/50). Prevent any upward flow or reverse flow in any part.
- 10 mm or thicker formed thermal insulator shall always be provided for the drain pipe.

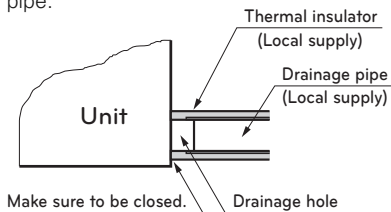

- Upward routing not allowed

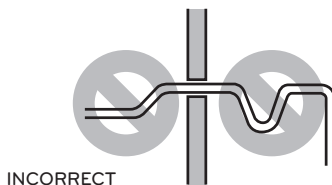

- Install the P-Trap (or U-Trap) to prevent a water leakage caused by the blocking of intake air filter.

Applied U-Trap Dimension

- A ≥ 70 mm(2-3/4 inch)
- B ≥ 2C
- C ≥ 2 x SP
- SP = External Pressure (mmAq(inAq))

- Ex) External Pressure = 10 mmAq (0.39 inAq)
- A ≥ 70 mm(2-3/4 inch)
- B ≥ 40 mm(1-9/16 inch)
- C ≥ 20 mm(25/32 inch)

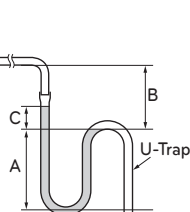
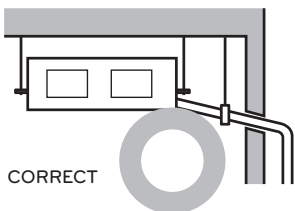

Air Filter

<TYPE A>

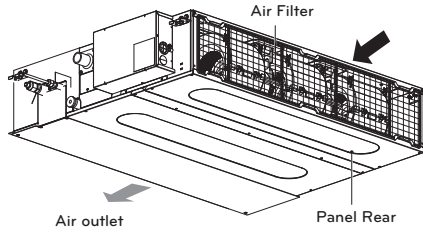

Low static duct type in case of suction from back side.

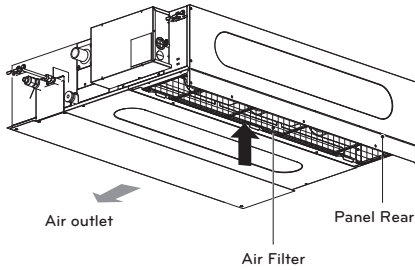

Low static duct type in case of suction from bottom side.

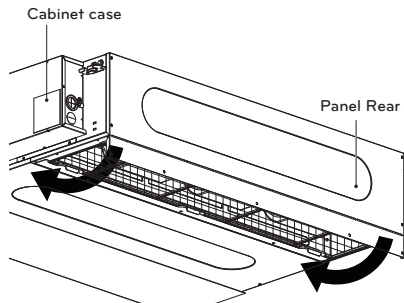

In case of suction from bottom size, bend the Panel rear and screw with cabinet case.

INSULATION, OTHERS

Insulate the joint and tubes completely.

THERMAL INSULATION

All thermal insulation must comply with local requirement.

INDOOR UNIT

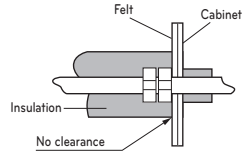
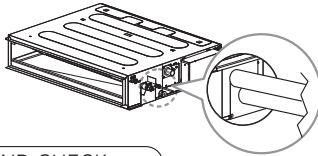
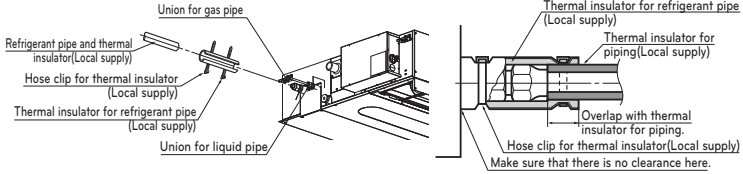

TEST AND CHECK

After all workings are finished, check the working and operation.

- Air distribution Is the air circulation good?
- Drain Is the drainage smoothly and no sweating?
- Gas leakage Is the piping connection correctly?
- Wiring Is the wiring connection correctly?
- Lock-bolt Is the lock-bolt of compressor loosened?
- Insulation Is the unit fully insulated?
- Ground Is the unit safely grounded?

Checking the Drainage

1 Remove the Air Filter.

<TYPE A/D>

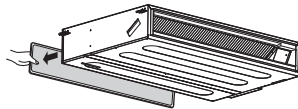

<TYPE B/C>

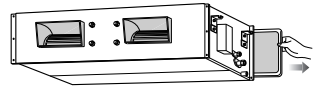

2 Check the drainage.

- Spray one or two glasses of water upon the evaporator.
- Ensure that water flows drain hose of indoor unit without any leakage.

<TYPE A/D>

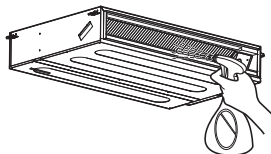

<TYPE B/C>

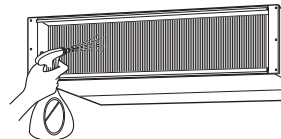

⚠ CAUTION

- Install declination of the indoor unit is very important for the drain of the duct type air conditioner.
- Minimum thickness of the insulation for the connecting pipe shall be 19 mm(3/4 inch).

Front of view

The unit must be horizontal or declined to the drain hose connected when finished installation.

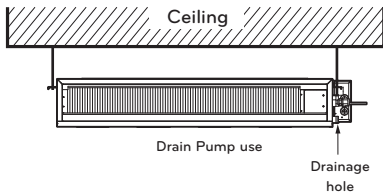

Indoor Unit Drain Piping (TYPE A/D)

- Drain piping must have down-slope (1/50 to 1/100): be sure not to provide up-and-down slope to prevent reversal flow.
- During drain piping connection, be careful not to exert extra force on the drain port on the indoor unit.
- The outside diameter of the drain connection on the indoor unit is 32 mm(1-1/4 inch).

Piping material: Polyvinyl chloride pipe VP-25 and pipe fittings

- Be sure to execute heat insulation on the drain piping.

Heat insulation material: Polyethylene foam with thickness more than 8 mm(5/16 inch).

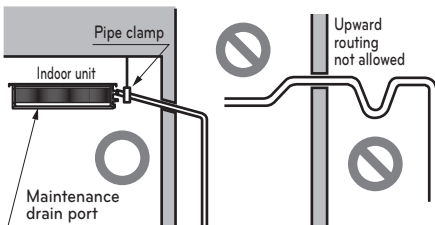

Drain test

The air conditioner uses a drain pump to drain water.

Use the following procedure to test the drain pump operation:

- Connect the main drain pipe to the exterior and leave it provisionally until the test comes to an end.
- Feed water to the flexible drain hose and check the piping for leakage.
- Be sure to check the drain pump for normal operating and noise when electrical wiring is complete.
- When the test is complete, connect the flexible drain hose to the drain port on the indoor unit.

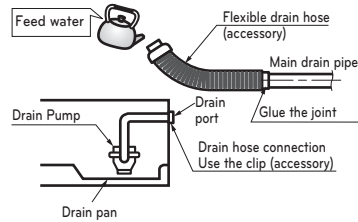

⚠ CAUTION

The supplied flexible drain hose should not be curved, neither screwed. The curved or screwed hose may cause a leakage of water.

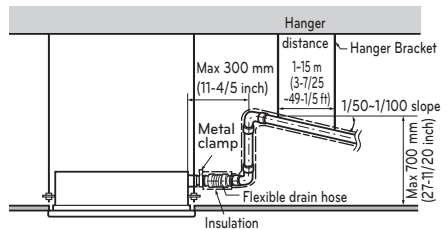

HAND OVER

Teach the customer the operation and maintenance procedures, using the operation manual.

(air filter cleaning, temperature control, etc.)

Combination indoor units (AMNW**G**AO / TYPE B / TYPE D)

The indoor units connectable to the outdoor unit are shown below

Indoor Unit		Outdoor Unit (Btu/h class)	
Type	Capacity (Btu/h class)	36 k	54 k
Vertical AHU	24 k	O	O
	36 k	X	O
Ceiling Concealed Duct (High Static)	24 k	O	O
	36 k	X	O

NOTE

- The total capacity(in Btu/h unit) of connected indoor unit models represents the total sum of the figures expressed in the indoor model name.
- Combinations in which the total capacity of the connected indoor units exceeds the capacity of the outdoor unit will reduce the capacity of each indoor unit below the rated capacity during simultaneous operation. Therefore, if circumstances allows, combine indoor units within the capacity of the outdoor unit.
- VAHU, Ceiling Concealed Duct(High Static) type indoor unit's combination calculation method as below.
Calculation method for total capacity of connectable indoor unit to an outdoor unit
= (Sum of all VAHU & Ceiling Concealed Duct(High Static) type indoor units capacity × 1.3) + Sum of all other indoor unit's capacity

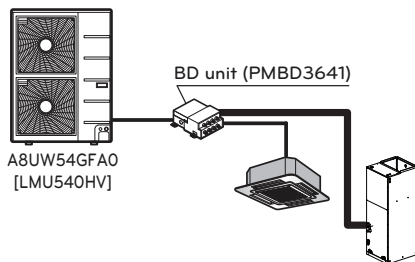

Outdoor Unit (Btu/h class)	Total capacity of connectable indoor units (Btu/h)
36 k	48 k
54 k	73 k

Example)

Total rated capacity index :

$$\begin{array}{r}
 4Way\ CST \\
 AMNW18GTQA0 \\
 [LMCN185HV] \\
 \\
 + \\
 \\
 VAHU \\
 AMNW36GNJA0 \\
 [LMVN360HV] \\
 \\
 \times 1.3 \\
 \\
 = \\
 64.8 < 73
 \end{array}$$

Flaring work

Main cause of gas leakage is defect in flaring work. Carry out correct flaring work in the following procedure.

1 Cut the pipes

- Use the accessory piping kit or the pipes purchased locally.
- Measure the distance between the indoor and the outdoor unit.
- Cut the pipes a little longer than measured distance.
- Cut the cable 1.5 m(4.9 ft) longer than the pipe length.

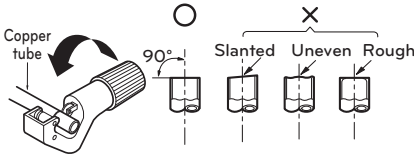

2 Burrs removal

- Completely remove all burrs from the cut cross section of pipe/tube.
- Put the end of the copper tube/pipe to downward direction as you remove burrs in order to avoid to let burrs drop in the tubing.

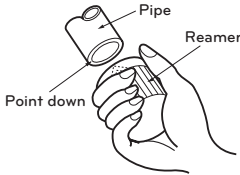

3 Putting nut on

- Remove flare nuts attached to indoor and outdoor units, than put them on pipe/tube having completed burr removal. (Not possible to put them on after flaring work)

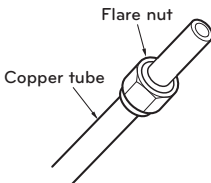

4 Flaring work

- Carry out flaring work using flaring tool as shown below.

Pipe diameter Inch (mm)	A Inch (mm)		Thickness Inch (mm)
	Wing nut type	Clutch type	
Ø 1/4 (Ø 6.35)	0.04~0.05 (1.1~1.3)	0~0.02 (0~0.5)	0.03 (0.7)
Ø 3/8 (Ø 9.52)	0.06~0.07 (1.5~1.7)		0.03 (0.8)
Ø 1/2 (Ø 12.7)	0.06~0.07 (1.6~1.8)		0.03 (0.8)
Ø 5/8 (Ø 15.88)	0.06~0.07 (1.6~1.8)		0.04 (1.0)
Ø 3/4 (Ø 19.05)	0.07~0.08 (1.9~2.1)		0.04 (1.0)

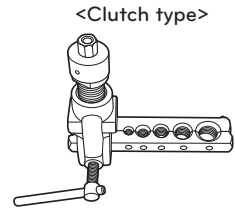
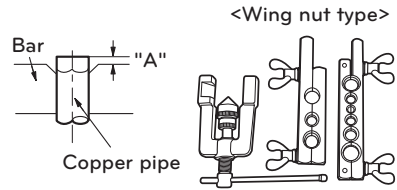

Firmly hold copper tube in a bar(or die) as indicated dimension in the table above.

5 Check

- Compare the flared work with figure.
- If flare is noted to be defective, cut off the flared section and do flaring work again.

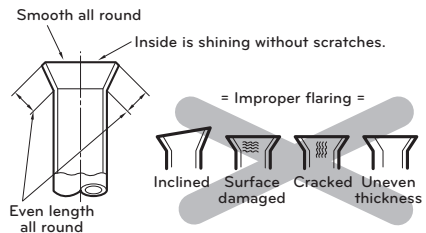

Connection of piping - Indoor, Outdoor, BD Unit

(AMNW**G**AO / AMNW18GL2A1 / TYPE B / TYPE D)

Align the center of the piping and sufficiently tighten the flare nut by hand.

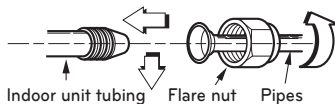

Capacity (kBtu/h)	Refrigerant Connections Pipe size	
	Liquid	Gas
24	1/4 (Ø 6.35)	1/2 (Ø 12.7)
36	3/8 (Ø 9.52)	5/8 (Ø 15.88)

ODU	Model	Refrigerant Connections Pipe size	
		Liquid	Gas
Single Zone	AMNW18GL2A1	3/8 (Ø 9.52)	5/8 (Ø 15.88)

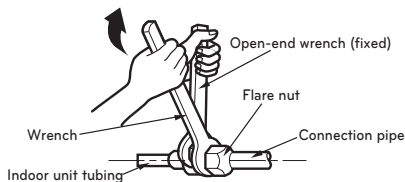

BD Unit	Refrigerant Connections Pipe Size (inch (mm))		Connectable Indoor Unit Capacity (kBtu/h class)
	Liquid	Gas	
PMBD3620	1/4 (Ø 6.35) x 2 EA	3/8 (Ø 9.52) x 2 EA	9/12/18/24 k
PMBD3630	1/4 (Ø 6.35) x 3 EA	3/8 (Ø 9.52) x 3 EA	9/12/18/24 k
PMBD3640	1/4 (Ø 6.35) x 4 EA	3/8 (Ø 9.52) x 4 EA	9/12/18/24 k
PMBD3641	1/4 (Ø 6.35) x 4 EA	3/8 (Ø 9.52) x 3 EA	9/12/18/24 k (A/B/C ROOM)
		1/2 (Ø 12.7) x 1 EA	36 k (D ROOM)

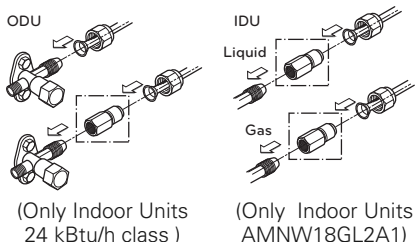

(Only Indoor Units
24 kBtu/h class)

(Only Indoor Units
AMNW18GL2A1)

(PMBD3620 / PMBD3630 /
PMBD3640)

* BD Unit(PMBD3641) includes the sockets.

(Ø 12.7 → Ø 15.88 x 1 EA,
Ø 6.35 → Ø 9.52 x 1 EA)

* AMNW18GL2A1 includes the sockets.

Ø 6.35 → Ø 9.52 x 1 EA, Ø 12.7 →
Ø 15.88 x 1 EA, Ø 9.52 → Ø 12.7 x 1 EA

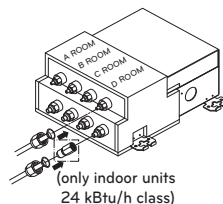

(PMBD3641)

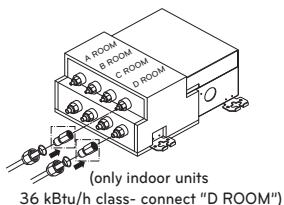

Finally, tighten the flare nut with torque wrench until the wrench clicks.

- When tightening the flare nut with torque wrench ensure the direction for tightening follows the arrow on the wrench.

Outside diameter		Torque		
mm	inch	N. m	kgf.m	lbf.ft
Ø 6.35	1/4	14~18	1.4~1.8	10~13
Ø 9.52	3/8	34~42	3.5~4.3	25~31
Ø 12.7	1/2	49~61	5.0~6.2	36~45
Ø 15.88	5/8	69~82	7.0~8.4	51~60
Ø 19.05	3/4	100~120	10.0~12.2	73~88

Plumbing materials and storage methods

Pipe must be able to obtain the specified thickness and should be used with low impurities. Also when handling storage, pipe must be careful to prevent a fracture, deformity and wound. Should not be mixed with contaminations such as dust, moisture.

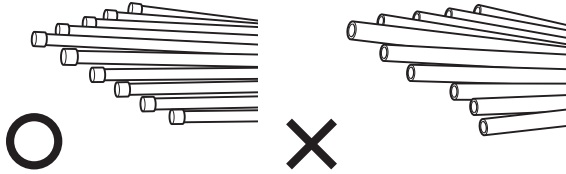

Refrigerant piping on three principles

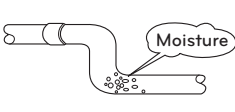
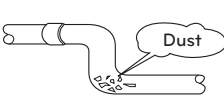
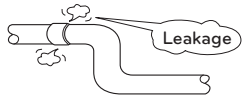
	Drying	Cleanliness	Airtight
	Should be no moisture inside	No dust inside.	There is no refrigerant leakage
Items			
Cause failure	<ul style="list-style-type: none"> - Significant hydrolysis of refrigerant oil - Degradation of refrigerant oil - Poor insulation of the compressor - Do not cold and warm - Clogging of EEV, Capillary 	<ul style="list-style-type: none"> - Degradation of refrigerant oil - Poor insulation of the compressor - Do not cold and warm - Clogging of EEV, Capillary 	<ul style="list-style-type: none"> - Gas shortages - Degradation of refrigerant oil - Poor insulation of the compressor - Do not cold and warm
Countermeasure	<ul style="list-style-type: none"> - No moisture in the pipe - Until the connection is completed, the plumbing pipe entrance should be strictly controlled. - Stop plumbing at rainy day. - Pipe entrance should be taken side or bottom. - When removal burr after cutting pipe, pipe entrance should be taken down. - Pipe entrance should be fitted cap when pass through the walls. 	<ul style="list-style-type: none"> - No dust in the pipe. - Until the connection is completed, the plumbing pipe entrance should be strictly controlled. - Pipe entrance should be taken side or bottom. - When removal burr after cutting pipe, pipe entrance should be taken down. - Pipe entrance should be fitted cap when pass through the walls. 	<ul style="list-style-type: none"> - Airtightness test should be. - Brazing operations to comply with standards. - Flare to comply with standards. - Flange connections to comply with standards.

Nitrogen substitution method

Welding, as when heating without nitrogen substitution a large amount of the oxide film is formed on the internal piping.

The oxide film is caused by clogging EEV, Capillary, oil hole of accumulator and suction hole of oil pump in compressor.

It prevents normal operation of the compressor.

In order to avoid this problem, Welding should be done after replacing air by nitrogen gas.

When welding plumbing pipe, the work is required.

◆How to work

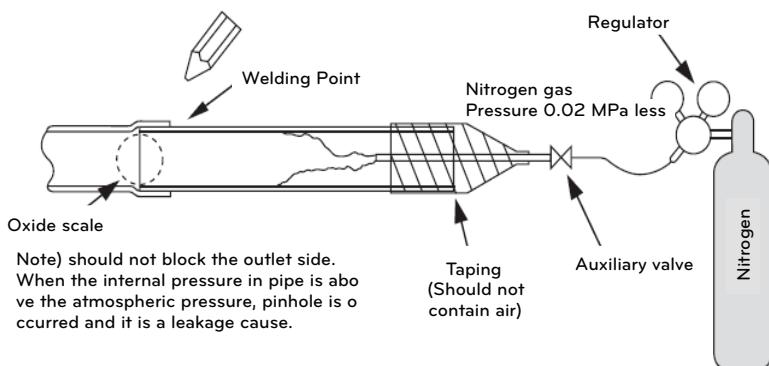

Note) should not block the outlet side.
When the internal pressure in pipe is above the atmospheric pressure, pinhole is occurred and it is a leakage cause.

⚠ CAUTION

1. Always use the nitrogen.(not use oxygen, carbon dioxide, and a Chevron gas):
Please use the following nitrogen pressure 0.02MPa
Oxygen — Promotes oxidative degradation of refrigerant oil.
Because it is flammable, it is strictly prohibited to use
Carbon dioxide — Degrade the drying characteristics of gas
Chevron Gas — Toxic gas occurs when exposed to direct flame.
2. Always use a pressure reducing valve.
3. Please do not use commercially available antioxidant.
The residual material seems to be the oxide scale is observed.
In fact, due to the organic acids generated by oxidation of the alcohol contained in the anti-oxidants, ants nest corrosion occurs. (causes of organic acid → alcohol + copper + water + temperature)

Indoor Unit Drain Piping (TYPE B / C)

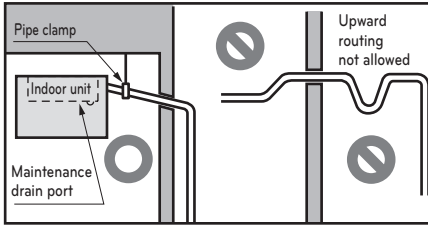

- Drain piping must have down-slope (1/50 to 1/100): be sure not to provide up-and-down slope to prevent reversal flow.
- During drain piping connection, be careful not to exert extra force on the drain port on the indoor unit.
- The outside diameter of the drain connection on the indoor unit is 32 mm(1-1/4 inch).

Piping material: Polyvinyl chloride pipe VP-25 and pipe fittings

- Be sure to execute heat insulation on the drain piping.
- Install the drain raising pipes at a right angle to the indoor unit and no more than 300 mm(11-13/16 inch) from the unit.

Heat insulation material: Polyethylene foam with thickness more than 8 mm(5/16 inch).

- Connect the main drain pipe to the exterior and leave it provisionally until the test comes to an end.
- Feed water to the flexible drain hose and check the piping for leakage.
- When the test is complete, connect the flexible drain hose to the drain port on the indoor unit.

- 1 Remove the Air Filter.

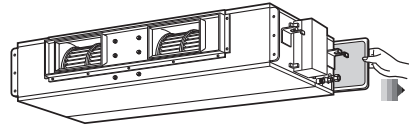

- 2 Check the drainage.

- Spray one or two glasses of water upon the evaporator.
- Ensure that water flows drain hose of indoor unit without any leakage.

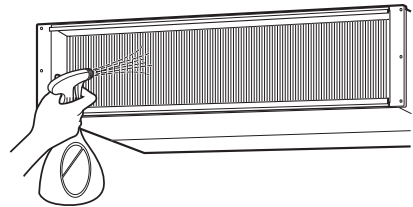

Drain test

(TYPE B / C)

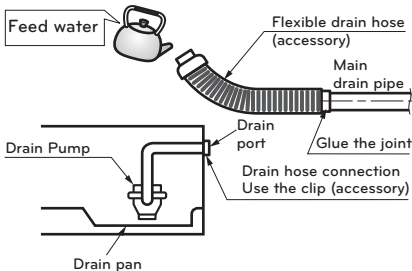

Heat insulation (TYPE B / C / D)

- 1 Use the heat insulation material for the refrigerant piping which has an excellent heat-resistance (over 120 °C).
- 2 Precautions in high humidity circumstance: This air conditioner has been tested according to the "KS Standard Conditions with Mist" and confirmed that there is not any default. However, if it is operated for a long time in high humid atmosphere (dew point temperature: more than 23 °C), water drops are liable to fall. In this case, add heat insulation material according to the following procedure:
 - Heat insulation material to be prepared...
Adiabatic glass wool with thickness 10 to 20 mm.
 - Stick glass wool on all air conditioners that are located in ceiling atmosphere.

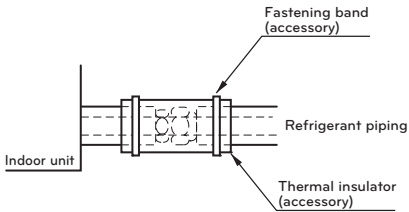

Wiring Connection

- Remove the control box cover for electrical connection between the indoor and outdoor unit. (Remove screws ①.)
- Open the control box cover and connect the Remote controller cord and Indoor power wires.
- Use the cord clamper to fix the cord.

<TYPE A>

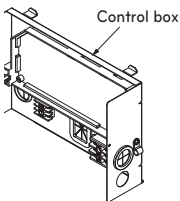

<TYPE B/C>

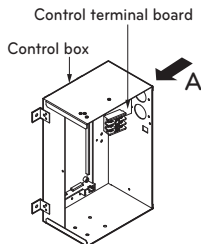

<TYPE A>

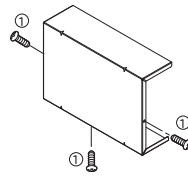

<TYPE B/C>

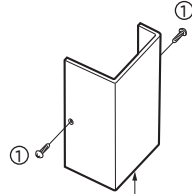

Control box cover
(On which the Electric
Wiring Connection is put)

Connection method of the connecting cable(Example)

<TYPE A>

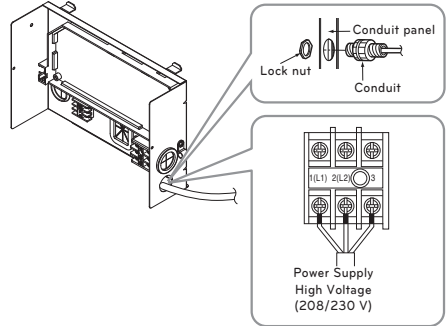

<TYPE B/C>

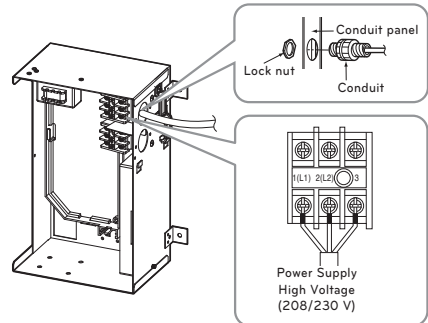

⚠ WARNING

Loose wiring may cause the terminal to overheat or result in unit malfunction. A fire hazard may also exist. Therefore, be sure all wiring is tightly connected.

<TYPE D>

- Open the control box cover and connect the remote controller cables, transmission cables and indoor power cables.
- Control box cover is consist of two panel which are side and bottom panel.

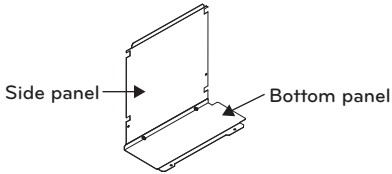

Control box cover can be separated from main body by 2 method.

- Case 1. Separate whole cover (when access from bottom of the product).
Remove screws on the bottom panel and grab the both panel with two hands and pull down the whole cover.

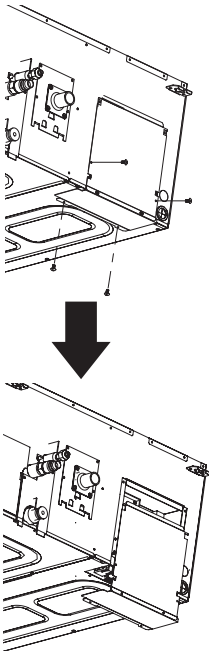

- Case 2. Separate only side panel (when access from side of the product).
Remove screws which are connecting two panel and pull down the side panel.

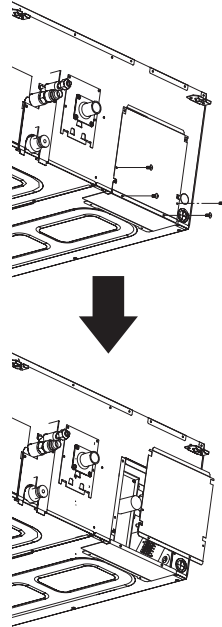

After remove the control box cover, insert cables onto the bush and conduit and then connect at terminal block.

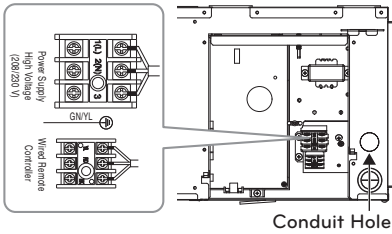
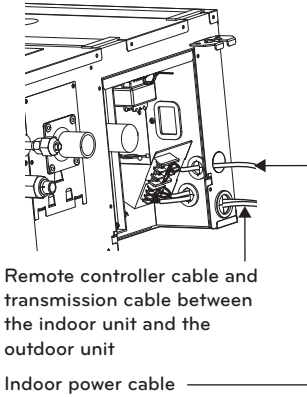

Insulation, others

Insulate the joint and tubes completely.

THERMAL INSULATION

All thermal insulation must comply with local requirement.

INDOOR UNIT

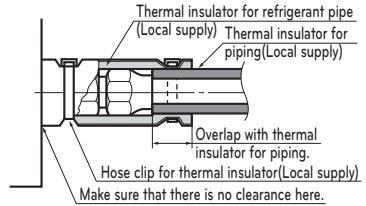
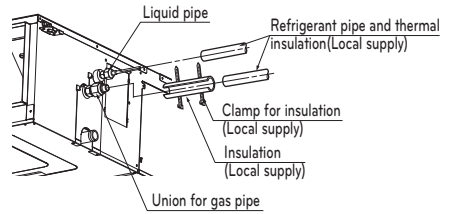

! CAUTION

The power connecting cable between the outdoor and indoor units must comply with the following specifications: NRTL Recognized (for example, UL or ETL recognized and CSA certified).

AWG 18-4 is the minimum recommended wire size, however, the selected conductors must comply with local codes and be suitable for installation in wet locations.

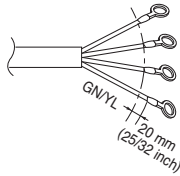

If the supply cord is damaged, it must be replaced by a special cord or assembly available from the manufacturer of its service agent. When the connection line between the indoor unit and outdoor unit and outdoor unit is over 40 m, connect the telecommunication line and power line separately.

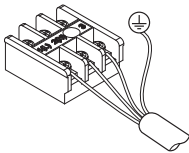

Precautions when laying power and ground wiring

Use round pressure terminals for connections to the power terminal block.

When laying ground wiring, you must use round pressure terminals.

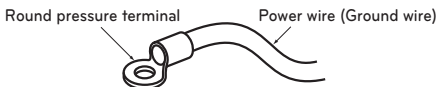

When none are available, follow the instructions below.

- Do not connect wiring of different thicknesses to the power terminal block. (Slack in the power wiring may cause abnormal heat.)
- When connecting wiring which is the same thickness, do as shown in the figure below.



- For wiring, use the designated power wire and connect firmly, then secure to prevent outside pressure being exerted on the terminal block.
- Use an appropriate screwdriver for tightening the terminal screws. A screwdriver with a small head will strip the head and make proper tightening impossible.
- Over-tightening the terminal screws may break them.

! NOTE

Use connection cable NRTL(UL, ETL, CAS...) listed and stranded copper(4) THHN conductors, sunlight (UV) resistant ROHS compliant PVC jacket 600 V direct burial listed, approved for wet conditions. Temperature rated for -20 °C(-4 °F) to 90 °C(194 °F). And this cable should be enclosed in conduit.

! WARNING

- Be sure to comply with local and national codes while running the wire from the indoor unit to the outdoor unit(size of wire and wiring method, etc).
- Every wire must be connected firmly.
- No wire should be allowed to touch refrigerant tubing, the compressor or any moving parts.
- The communication wirings of air conditioner should be separate and isolated from external device's electric wiring such as computers, elevator, radio & Television broadcasting facilities, as well as medical imaging offices.

REMOTE CONTROLLER INSTALLATION

※ Remote controller is provided as an accessory.

Please fix tightly using provided screw after placing remote controller setup board on the place where you like to setup.

- Please set it up not to bend because poor setup could take place if setup board bends.
- Please set up remote controller board fit to the reclamation box if there is a reclamation box.

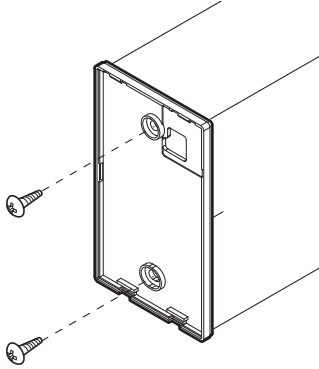

Can set up Wired remote controller cable into three directions.

- Setup direction: the surface of wall reclamation, upper, right
- If setting up remote controller cable into upper and right side, please set up after removing remote controller cable guide groove.
- * Remove guide groove with long nose.

- ① Reclamation to the surface of the wall
- ② Upper part guide groove
- ③ Right part guide groove

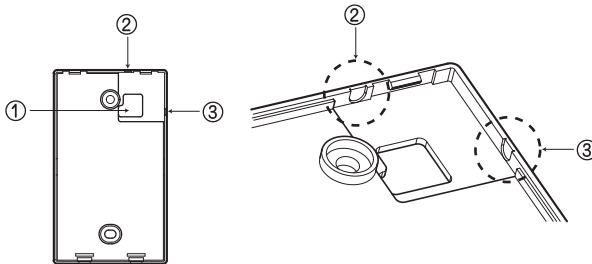

<Wire guide grooves>

Please connect indoor unit and remote controller using connection cable.

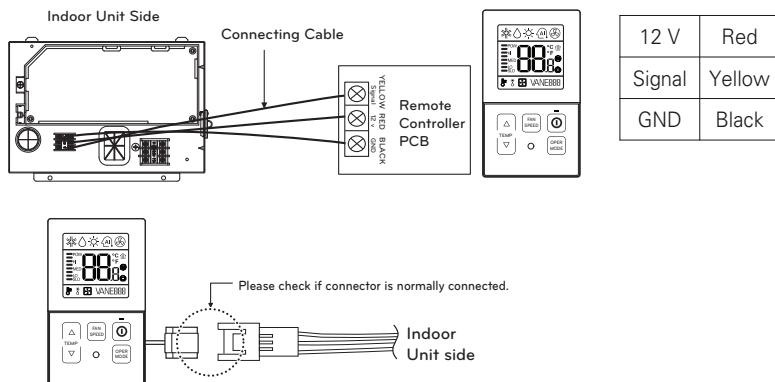

Please use extension cable if the distance between wired remote controller and indoor unit is more than 10 m (32-4/5 ft).

Please fix remote controller upper part into the setup board attached to the surface of the wall, as the picture below, and then, connect with setup board by pressing lower part.

- Please connect not to make a gap at the remote controller and setup board's upper and lower, right and left part.

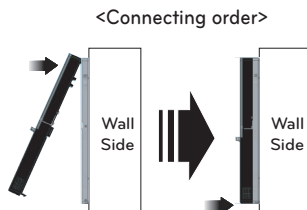

When separating remote controller from setup board, as the picture below, after inserting into the lower separating hole using screw driver and then, spinning clockwise, remote controller is separated.

- There are two separating holes. Please individually separate one at a time.
- Please be careful not to damage the inside components when separating.

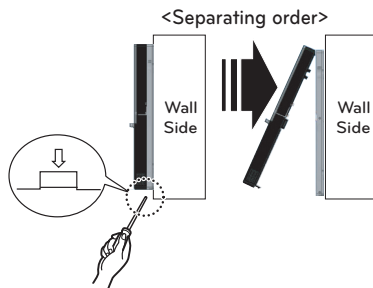

CAUTION

When installing the wired remote controller, do not bury it in the wall. (It can cause damage in the temperature sensor.) Do not install the cable to be 50 m or above. (It can cause communication error.)

- When installing the extension cable, check the connecting direction of the connector of the remote controller side and the product side for correct installation.
- If you install the extension cable in the opposite direction, the connector will not be connected.
- Specification of extension cable: 2547 1007 22# 2 core 3 shield 5 or above.
- Apply totally enclosed noncombustible conduit in case of local building code Requiring plenum cable usage.

<TYPE C>

When connecting Terminal Blocks of the indoor C/BOX and the wired remote controller with the extension cable, refer to the steps below.

- ① Remove the screw on the cable which is fastened to the wired remote controller's Terminal Block by loosening with a screw driver.
- ② Remove the housing of the provided 32 ft extension cable with a cutting nipper and peel it as shown in the figure below. (when purchasing the extension cable at the site directly, please peel it as shown in the figure below.)

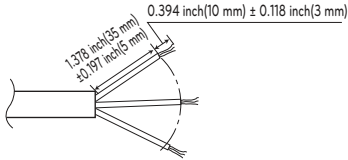

Signal	Yellow
12 V	Red
GND	Black

Wired remote controller installation

Since the room temperature sensor is in the remote controller, the remote controller box should be installed in a place away from direct sunlight, high humidity and direct supply of cold air to maintain proper space temperature. Install the remote controller about 5 ft (1.5 m) above the floor in an area with good air circulation at an average temperature.

Do not install the remote controller where it can be affected by:

- Drafts, or dead spots behind doors and in corners.
- Hot or cold air from ducts.
- Radiant heat from sun or appliances.
- Concealed pipes and chimneys.
- Uncontrolled areas such as an outside wall behind the remote controller.
- This remote controller is equipped with LCD display. For proper display of the remote controller LCD's, the remote controller should be installed properly as shown in Fig.1. (The standard height is 4~5 ft (1.2~1.5 m) from floor level.)

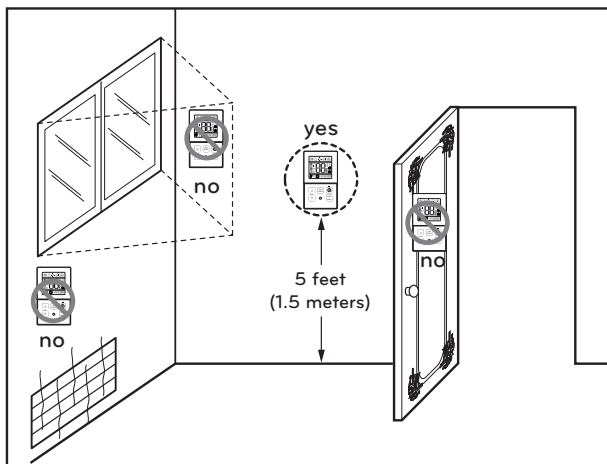

[Fig.1]

HOW TO SET E.S.P?

Installer Setting - E.S.P.

This is the function that decides the strength of the wind for each wind level and because this function is to make the installation easier.

- If you set ESP incorrectly, the air conditioner may malfunction.
- This setting must be carried out by a certificated-technician.

※ The procedure of setting E.S.P. is refer to the manual of remote controller.

- Precaution shall be taken not to alter the E.S.P value corresponded to each air flow section.
- E.S.P value can be varied according to the products.
- In the case of going to the next air flow rate stage by pressing the fan-speed button during the setup of the E.S.P value, the E.S.P value of previous air flow rate will be maintained by remembering the E.S.P value prior to the shift.

<TYPE A>

(Unit : CMM)

Capacity	Step	CFM	Static Pressure(mmAq(in.Aq))					
			0(0)	1(0.04)	2(0.08)	3(0.12)	4(0.16)	5(0.2)
			Setting Value					
9 k	HIGH	318	98	103	108	116	125	130
	MID	247	82	88	94	102	110	118
	LOW	194	69	76	83	91	99	109
12 k	HIGH	353	95	99	104	109	116	125
	MID	300	86	91	96	101	108	116
	LOW	247	78	82	87	93	100	108
18 k	HIGH	530	123	125	129	134	140	145
	MID	441	109	112	117	123	129	136
	LOW	353	95	99	104	109	116	124

<TYPE B>

Capacity	Step	CFM	Static Pressure(mmAq(in.Aq))									
			2.5(0.1)	4(0.15)	6(0.23)	8(0.31)	10(0.39)	12(0.47)	14(0.55)	16(0.62)	18(0.70)	20(0.78)
			Setting Value									
24 k	HIGH	688	82	92	103	113	122	131	140	147	154	160
	MID	618	78	89	99	110	119	128	137	144	151	157
	LOW	530	73	86	96	107	116	125	134	141	148	154
36 k	HIGH	1 130	-	124	133	140	148	154	160	-	-	-
	MID	953	-	112	122	130	137	155	152	-	-	-
	LOW	706	-	97	107	117	125	133	141	-	-	-

<TYPE C>

Capacity	Step	CFM	Static Pressure(mmAq(in.Aq))										
			2.5(0.1)	4(0.15)	6(0.23)	8(0.31)	10(0.39)	12(0.47)	14(0.55)	15(0.6)	16(0.62)	18(0.70)	20(0.78)
			Setting Value										
24 k	HIGH	688	90	97	108	119	126	134	143	146	149	157	159
	MID	618	86	93	105	115	123	131	140	143	146	153	156
	LOW	530	82	90	102	112	120	128	137	140	143	150	153
36 k	HIGH	1 130	-	96	103	109	115	120	126	129	-	-	-
	MID	953	-	85	96	102	109	115	121	124	-	-	-
	LOW	706	-	76	85	95	100	107	113	116	-	-	-

<TYPE D>

Capacity	Step	CFM	Static Pressure(mmAq(in.Aq))											
			2.5(0.1)	4(0.16)	5(0.2)	6(0.24)	7(0.28)	8(0.31)	9(0.35)	10(0.39)	11(0.43)	12(0.47)	13(0.51)	15(0.59)
			Setting Value											
24 k	HIGH	777	110	117	121	124	127	130	133	136	137	-	138	140
	MID	706	102	110	114	118	120	125	127	130	133	-	134	136
	LOW	636	96	102	107	110	114	118	122	125	127	-	130	132
36 k	HIGH	1 130	-	109	112	115	119	122	126	128	131	134	137	144
	MID	989	-	101	105	108	112	115	119	123	127	130	133	138
	LOW	848	-	92	97	101	105	109	113	117	121	124	127	134

SELF-DIAGNOSIS FUNCTION

Indoor Unit Error

Ex) Error 03 (Remote controller error)

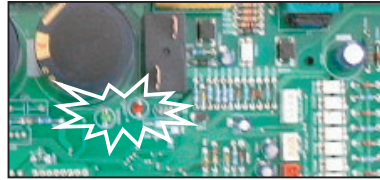
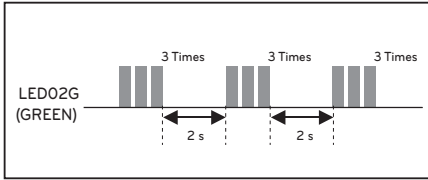

Error Code	Description	LED 1(Red)	LED 2(Green)	Indoor status
01	Indoor Room sensor error	0	1 time ●	OFF
02	Indoor in-pipe sensor error	0	2 times ●	OFF
03	Remote controller error	0	3 times ●	OFF
04	Drain pump error	0	4 times ●	OFF
05	Communication error indoor and outdoor	0	5 times ●	OFF
06	Indoor out-pipe sensor error	0	6 times ●	OFF
09	EEPROM error (indoor)	0	9 times ●	OFF
10	BLDC motor fan lock (indoor)	1 time ●	0	OFF

* Because remote controller turn off when occur ERROR in simultaneous operation system, it should check LED blinks of outdoor in order to confirm error code.

* Repeatedly after LED1 is turned on and off as the Error code number of tens digit, LED2 is turned on and off as the Error code number of single-digit.

DIP SWITCH SETTING

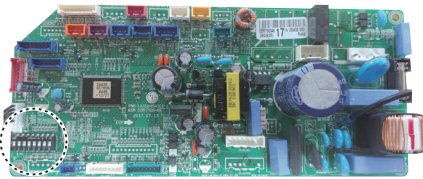
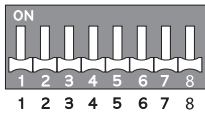

Indoor PCB

Function	Description	Setting Off	Setting On	Default	
SW3	Group Control	Selection of Master or Slave	Master	Slave	Off
SW4	Dry Contact Mode	Selection of Dry Contact Mode	Wired/Wireless remote controller Selection of Manual or Auto operation Mode	Auto	Off
SW5	Installation	Fan continuous operation	Continuous operation Removal	Working	Off



US	Please call the installing contractor of your product, as warranty service will be provided by them.
CANADA	Service call Number # : (888) LG Canada, (888) 542-2623 Numéro pour les appels de service : LG Canada, 1-888-542-2623